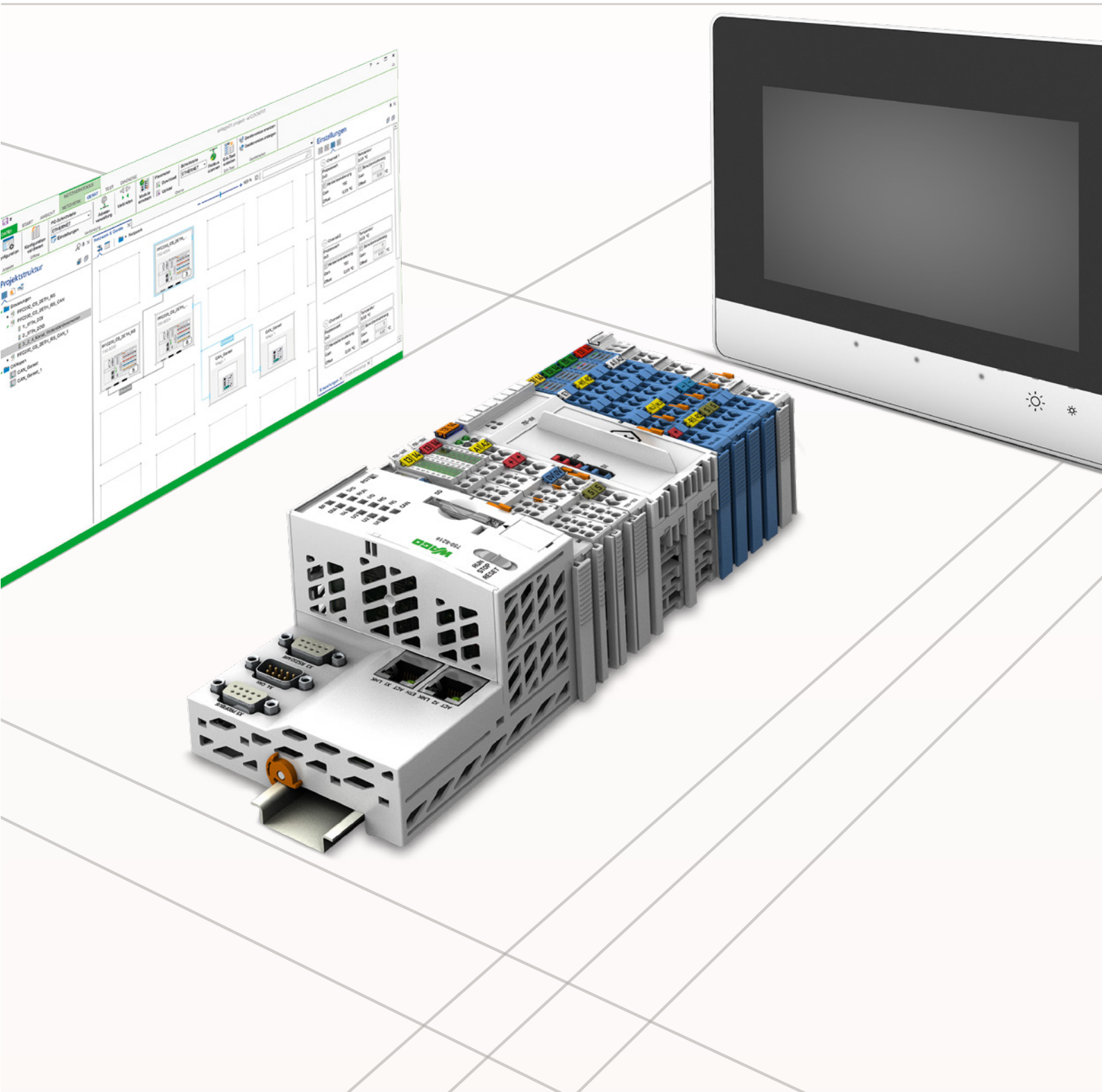


# Automation Technology

Full Line Catalog, Volume 3 – Edition 2019/2020

# 3



# WAGO Full Line Catalogs



## Volume 1, WAGO Rail-Mount Terminal Block Systems

- Rail-Mount Terminal Blocks
- Rail-Mount Terminal Blocks with Pluggable Connector (X-COM®-SYSTEM)
- Patchboard Systems
- Terminal Strips
- PUSH WIRE® Connectors for Junction Boxes
- Lighting Connectors
- Shield Connecting System



## Volume 2, WAGO PCB Terminal Blocks and WAGO Connectors

- PCB Terminal Blocks
- THR/SMD PCB Terminal Blocks
- *MULTI CONNECTION SYSTEM (MCS)*
- Pluggable PCB Terminal Blocks
- Feedthrough Terminal Blocks
- Specialty Connectors
- Empty Housings



## Volume 3, Automation Technology

- Solutions & Software
- Operating & Monitoring
- Controllers
- Modular I/O-SYSTEM, IP20
- Industrial Switches
- Radio Technology
- IP67 Sensor/Actuator Boxes, IP67 Cables and Connectors



## Volume 4, WAGO Interface Electronic

- Relay and Optocoupler Modules
- Signal Conditioners and Isolation Amplifiers
- Current and Energy Measurement Technology
- Power Supplies
- Interface Modules and System Wiring
- Overvoltage Protection
- Empty Housings



## Volume 5, WAGO Pluggable Connection System WINSTA®


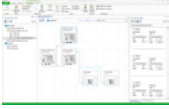










- Pluggable Connectors
- Snap-In Device Connectors
- Pluggable PCB Connectors
- Distribution Connectors
- Cable Assemblies
- Flat Cable Systems
- Distribution Boxes




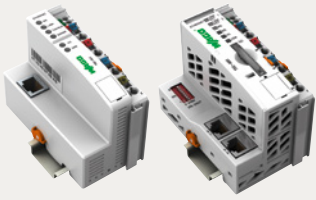

## Volume 6, WAGO Marking




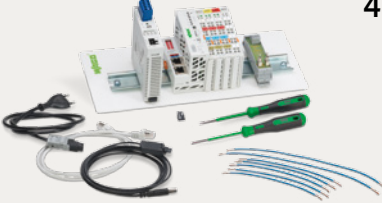

- Printer
- Software
- Terminal Block Marking
- Cable and Conductor Marking
- Device Marking
- Marker Carriers

## Volume 3, Automation Technology

		Page		
Solutions		<b>Solutions</b> Cloud Solutions, Software Applications	4	<b>1</b>
Software		<b>Software</b> Engineering Software, Runtime Software, Mobile Software (Apps)	22	<b>2</b>
Operation Monitoring		<b>Operation and Monitoring</b> Web, Visu and Control Panels	50	<b>3</b>
Controllers		<b>Controllers</b> PFC100/PFC200, PFC200 XTR, Controllers 750, Controllers 750 XTR, Starter Kits	70	<b>4</b>
I/O Systems		<b>I/O System – 750 and 753 Series</b> Fieldbus Couplers and I/O Modules (IP20)	136	<b>5</b>
		<b>I/O System – 750 XTR Series</b> Fieldbus Couplers and I/O Modules (IP20) for eXTReme Environments	344	<b>6</b>
Infrastructure		<b>Industrial Switches</b>	394	<b>7</b>
		<b>Radio Technology</b> <i>Bluetooth</i> <sup>®</sup> , EnOcean and WLAN Components	414	<b>8</b>
		<b>Sensor/Actuator Boxes</b> M8 and M12 Passive Distribution Boxes (IP67)	426	<b>9</b>
		<b>Accessories and Tools</b>	446	<b>10</b>
		<b>Technical Section</b>	514	<b>11</b>
		<b>Indexes and Addresses</b>	544	<b>12</b>

# WAGO Automation Technology

Solutions & Software	<p><b>Solutions</b></p>  <p><b>1</b></p> <ul style="list-style-type: none"> <li>• Cloud solutions</li> <li>• Reusable, customizable software applications</li> </ul>	<p><b>Engineering Software</b></p>  <ul style="list-style-type: none"> <li>• PC-based software</li> <li>• Customized tools for every automation task</li> </ul>	<p><b>Runtime Software</b></p>  <ul style="list-style-type: none"> <li>• Standard machine component</li> <li>• Comprehensive, tested software modules for control, regulation, operation &amp; monitoring</li> </ul>
	<p><b>Touch Panels 600 Standard Line</b></p>  <ul style="list-style-type: none"> <li>• High-performance touch panels with resistive touch-screens</li> <li>• 10.9 ... 25.7 cm (4.3 ... 10.1")</li> <li>• Models include Control, Visu or Web Panel for display of visualizations</li> </ul>	<p><b>Touch Panels 600 Advanced Line</b></p>  <ul style="list-style-type: none"> <li>• High-performance touch panels with capacitive touch-screens and glass surfaces</li> <li>• 18 ... 25.7 cm (7 ... 10.1")</li> <li>• Models include Control or Visu Panel</li> </ul>	<p><b>Touch Panels 600 Marine Line</b></p>  <ul style="list-style-type: none"> <li>• High-performance touch panels with resistive touch-screens</li> <li>• Ideal for marine applications</li> <li>• 10.9 ... 25.7 cm (4.3 ... 10.1")</li> <li>• Models include Visu Panel</li> </ul>
	<p><b>Controllers PFC100/PFC200</b></p>  <p><b>4.1</b></p> <ul style="list-style-type: none"> <li>• Maximum performance in a minimum space</li> <li>• Also programmable in high-level languages based on Linux®</li> <li>• Security packages with SSH and SSL/TLS</li> <li>• Runtime system for CODESYS V2 (only PFC200) and V3</li> </ul>	<p><b>Controllers PFC200 XTR</b></p>  <p><b>4.2</b></p> <ul style="list-style-type: none"> <li>• The advantages of WAGO's PFC Controllers combined with the capabilities for extreme environments:</li> <li>• High processing speed</li> <li>• Multiple interfaces</li> <li>• eXTRemely robust and maintenance-free</li> </ul>	<p><b>Controllers 750</b></p>  <p><b>4.3</b></p> <ul style="list-style-type: none"> <li>• Controllers for all prominent fieldbus systems</li> <li>• Programmable to IEC 61131-3</li> <li>• Combinable with the modules of the WAGO-I/O-SYSTEM 750</li> </ul>
<p><b>I/O System – 750 and 753 Series</b></p>  <p><b>5</b></p> <ul style="list-style-type: none"> <li>• Highly versatile</li> <li>• More than 500 modules available</li> <li>• Functional Safety</li> <li>• Ex i</li> </ul>	<p><b>I/O System – 750 XTR Series</b></p>  <p><b>6</b></p> <p>For demanding applications where the following are critical:</p> <ul style="list-style-type: none"> <li>• Extreme temperature stability</li> <li>• Immunity to electromagnetic interference and impulse voltages</li> <li>• Vibration and shock resistance</li> </ul>		
<p><b>Industrial Switches</b></p>  <p><b>7</b></p> <ul style="list-style-type: none"> <li>• Copper cables</li> <li>• Fiber optic cables</li> <li>• Ring redundancy</li> </ul>	<p><b>Radio Technology</b></p>  <p><b>8</b></p> <ul style="list-style-type: none"> <li>• Bluetooth®</li> <li>• WLAN</li> <li>• EnOcean®</li> </ul>	<p><b>Sensor/Actuator Boxes</b></p>  <p><b>9</b></p> <ul style="list-style-type: none"> <li>• M8 and M12 sensor/actuator boxes</li> <li>• Passive signal acquisition and output at the machine level</li> <li>• Fully encapsulated</li> </ul>	

<p><b>Mobile Software (Apps)</b></p>  <ul style="list-style-type: none"> <li>Machine operation and monitoring on tablet and smartphone</li> </ul>	<h1>2</h1>	<p><b>1 Solutions</b></p> <ul style="list-style-type: none"> <li>Cloud Solutions 8</li> <li>Software Applications 12</li> </ul> <p><b>2 Software</b></p> <ul style="list-style-type: none"> <li>Engineering Software 26</li> <li>Runtime Software 42</li> <li>Mobile Software (Apps) 46</li> </ul>
<p><b>Touch Panels e!DISPLAY 7300T</b></p>  <ul style="list-style-type: none"> <li>Touch panels with resistive touchscreens</li> <li>10.9 ... 25.7 cm (4.3 ... 10.1")</li> <li>Models include Web Panel for display of CODESYS V2 or e!COCKPIT visualizations</li> </ul>	<h1>3</h1>	<p><b>3 Operation and Monitoring</b></p> <ul style="list-style-type: none"> <li>Touch Panels 600 Standard Line 58</li> <li>Touch Panels 600 Advanced Line 62</li> <li>Touch Panels 600 Marine Line 64</li> <li>Touch Panels e!DISPLAY 7300T 66</li> </ul>
<p><b>Controllers 750 XTR</b></p>  <p style="text-align: right;"><b>4.4</b></p> <p>For demanding applications where the following are critical:</p> <ul style="list-style-type: none"> <li>Extreme temperature stability</li> <li>Immunity to electromagnetic interference and impulse voltages</li> <li>Vibration and shock resistance</li> </ul>	<p><b>Starter Kits</b></p>  <p>To get you up and running quickly, we offer starter kits to suit the most diverse applications:</p> <ul style="list-style-type: none"> <li>with Controller PFC100</li> <li>with Controller PFC200</li> <li>with Controller 750 ETHERNET</li> <li>with Controller 750 KNX IP or BACnet/IP</li> </ul> <p style="text-align: right;"><b>4</b></p> <p style="text-align: right;"><b>4.5</b></p>	<p><b>4 Controllers</b></p> <ul style="list-style-type: none"> <li>3 Touch Panels 600 Standard Line 58</li> <li>Touch Panels 600 Advanced Line 62</li> <li>4.1 Controllers PFC100/PFC200 72</li> <li>4.2 Controllers PFC200 XTR 94</li> <li>4.3 Controllers 750 102</li> <li>4.4 Controllers 750 XTR 120</li> <li>4.5 Starter Kits 128</li> </ul>
		<p><b>I/O Systems</b></p> <p><b>5 750 and 753 Series</b> 136</p> <ul style="list-style-type: none"> <li>5.1 Fieldbus Couplers 146</li> <li>5.2 Digital Input Modules 162</li> <li>5.3 Digital Output Modules 192</li> <li>5.4 Analog Input Modules 212</li> <li>5.5 Analog Output Modules 246</li> <li>5.6 Function/Technology Modules 256</li> <li>5.7 Communication Modules 276</li> <li>5.8 Functional Safety 296</li> <li>5.9 Intrinsically Safe Modules 308</li> <li>5.10 Supply and Segment Modules 322</li> </ul> <p><b>6 750 XTR Series</b> 344</p>
<p><b>Accessories Tools</b></p>  <p style="text-align: right;"><b>10</b></p>		<p><b>Infrastructure</b></p> <ul style="list-style-type: none"> <li>7 Industrial Switches 394</li> <li>8 Radio Technology 414</li> <li>9 Sensor/Actuator Boxes 426</li> <li>10 Accessories 446</li> <li>Power Supplies</li> <li>Cables and Pluggable Connectors, IP67</li> </ul>



# Solutions

## Cloud Solutions

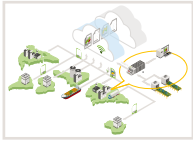
- "Internet of Things" (IoT) applications

## Software Applications

- Reusable, customizable solutions

## Solutions

### Cloud Solutions, Software Applications



	Page
<b>General Product Information</b>	6
<b>Cloud Solutions</b>	
WAGO Cloud	8
Cloud Connectivity via MQTT	11
<b>Software Applications</b>	
Energy Data Management Application	12
digitalTAP(tm) – Powered by MTCconnect	14
flexROOM® Application	16
Light Management Application	18
Gateway Application	20

## Solutions

### General Product Information

1

#### We Make It Simple!

WAGO products are at home in many industries. Tailored solutions make it easy for the customer to accomplish the task using WAGO products – in the form of libraries and complete products, regardless of industry.

#### Cloud Solutions

Digitization and networking offer great opportunities for every company. To use them, every company has to do its homework – in fact, the challenges are just as varied and diverse as the companies themselves. While there is no such thing as an all-in-one solution, smart products, methods, and partners will help you advance digitization in your business in a way that benefits all involved.

WAGO shapes the digital future with you. Cloud solutions have become popular industry staples. They link the real and digital worlds, allow efficient use of production-related data and simplify cross-site networking of global communication structures. This creates many new opportunities for the manufacturing industry – especially with an eye to plant availability and process optimization.

#### Scalable Solution Thanks to Our Reliable Partner



Member of **WAGO** Group

With M&M as a member of the WAGO Group, WAGO has a partner for integrated development of industrial and technical software solutions. We collaborate closely with Microsoft to implement corresponding solutions in the cloud and IoT, primarily using Azure.

#### Application Software

Prepared applications make it easy to use the WAGO products. We offer a range of complete industry-specific solutions such as **flexROOM**®, dramatically shorten time to completion. But also industry-independent universally usable solutions are available (closed or adaptable) and are optimally adapted to the respective hardware.

#### Standardized Applications

The more prepared, the easier it gets. For many applications, we offer configuration via web browser, with a standard PC without special software. Thanks to a flexible software architecture, it is also possible to realize individual configurations. Here we combine the advantage of reusing a standardized and field-proven solution with customization via parameterization instead of individual programming. This saves costs by shortening the time required and makes commissioning easy!

#### Tailor-Made Applications

If a standard solution does not fit, we can create a highly tailored, customer-specific approach that's as unique as your application. If necessary, just contact us. We are happy to assist you!

#### Advantages:

- Solutions for digitization
- Support for Industry 4.0/Internet of Things (IoT)
- Prepared field-tested applications for solving standard requirements in various industries
- Support with individual adjustments



## Solutions

### General Product Information

#### Cloud Solutions

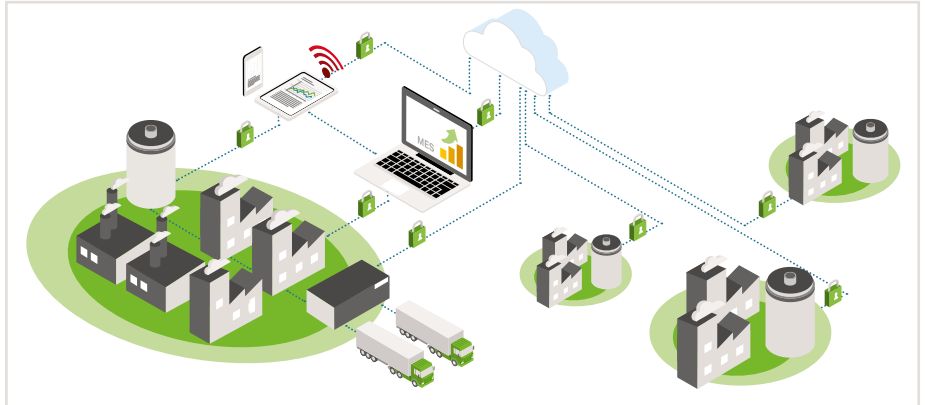
The universal cloud solution from WAGO is suitable for a wide variety of applications. This solution offers:

##### WAGO Cloud:

- Capture and save data
- Setting up individual dashboards
- Central condition monitoring and alarm handling
- Central data visualization via location-independent access

##### Cloud Connectivity:

- Establishing connections
- Secure communication



#### Application Software – Industry-Independent Solutions

Many solutions can be used regardless of industry, such as our energy management. With our modular energy data collection, we rely on an open and flexible system that you can easily install and extend. It doesn't matter if you are looking for an individual solution or want to use our standard solution.



#### Building Automation

Whether you are planning lighting installations and automation in your office building, retrofitting a heating, ventilation and air-conditioning system or involved with room automation, WAGO helps implement your requirements in buildings, both in office and administrative buildings, as well as in production and warehouses, retail or infrastructure buildings.



#### Power Engineering

Energy suppliers need to change the way they think. Instead of merely selling green energy, they also need to organize and market the flexibility that is required for maintaining stability on the electrical grid. This means that the energy system needs to be controllable from production to consumption using intelligent communication networks. WAGO supports digitizing the energy sector and design of smart grids with state-of-the-art control and measurement technology, along with software solutions that enable a simple and secure connection to the cloud.



## WAGO Cloud

### Collect, Analyze and Manage Data Centrally

1

The WAGO Cloud gives you the option of collecting data from various machines and managing it centrally.

The WAGO Cloud makes it possible to manage and monitor WAGO's controllers, including their data and applications. It is hosted on Microsoft's Azure Cloud. With simple, user-friendly operation, it was developed so that even people without IT experience can use it.

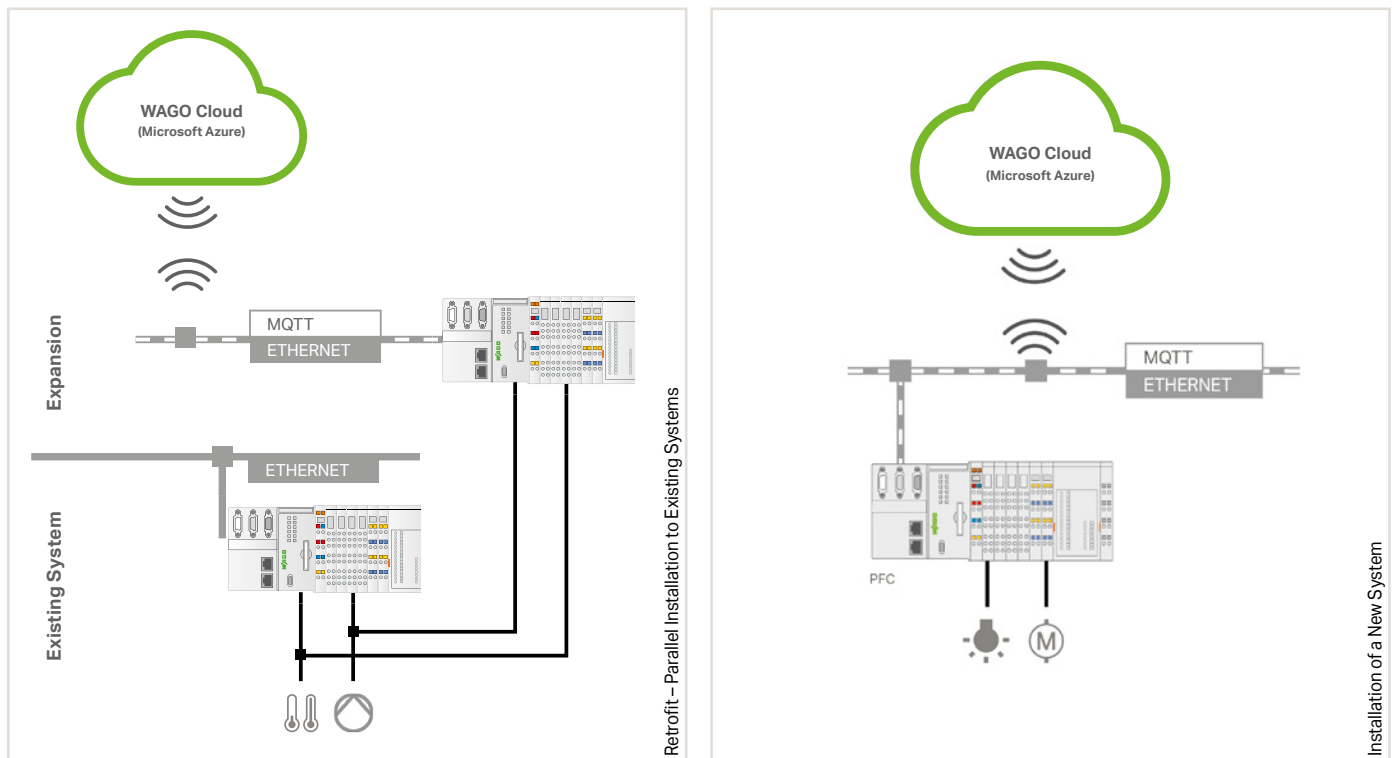
The cloud service is available online at <https://cloud.wago.com/>. After registering for free and linking to the WAGO Controllers, you can get started in just a few a few minutes.

### How does machine data get to the WAGO Cloud?

A WAGO PFC Controller serves as a gateway, collects the data and then sends it to the WAGO Cloud. Users log into their user interface on the Web portal, where they can use various applications: They have access to functions like visualizations, controller and user management, as well as controller status monitoring. They can also activate alarm functions and use them to automatically send email notifications if defined limit values are exceeded, for example. Data can be graphically visualized, evaluated and exported as needed.

### Do you need to restrict the data you send to the cloud?

No problem! You decide yourself by configuring the WAGO PFC Controller, specifying what data to send to the cloud or not via IEC program.



Figures: Data Transfer to the WAGO Cloud

The WAGO PFC Controller functions as a gateway for existing systems. It extends existing systems easily. It collects the data through various protocols and transports this data to the WAGO Cloud via the TSL-encrypted MQTT connection. If the system is newly installed and the WAGO PFC Controller is used, it can send the data directly to the cloud.

### What advantages does the WAGO Cloud offer?

#### • Simplicity

The solution is intuitive thanks to a clear functional scope. Within minutes, you can send data to the cloud, without extensive IT expertise.

#### • Flexibility

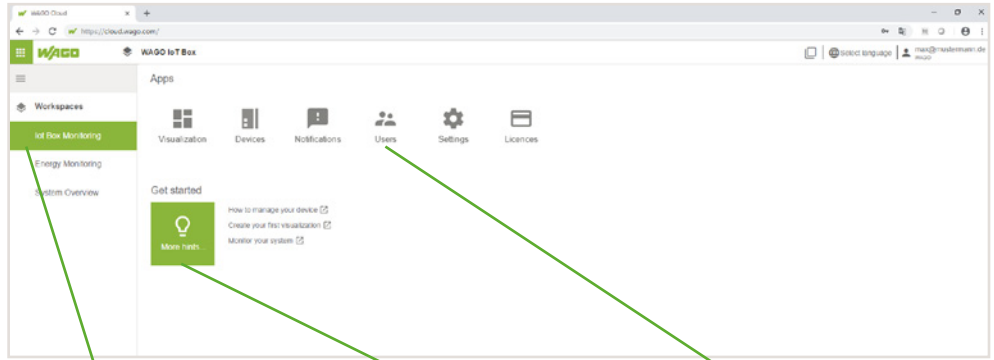
Customize your cloud solution at any time, and do so virtually whenever or wherever. For instance, double your number of controllers from one day to the next without affecting performance and availability. Would you like a special expansion? We can do that through customized cloud-expansions as a project service.

#### • Everything from a single source

Take advantage of the benefits of the WAGO Cloud, software as a service. Save time by passing the work of infrastructures and security platform and application management on to WAGO.

# WAGO Cloud

**App Overview:**  
All functions at a glance thanks to an intuitive app structure

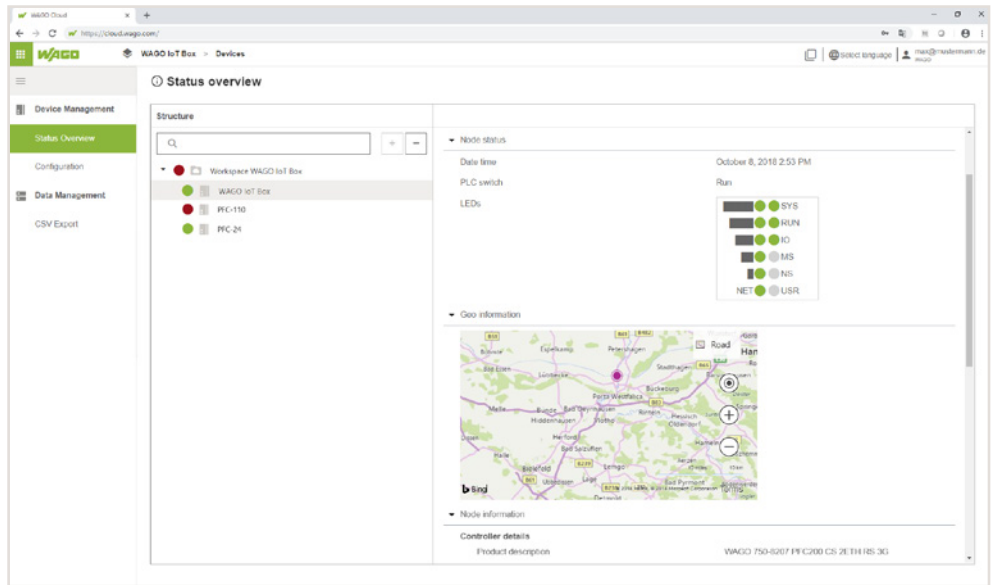


**Quick Access:**  
• Quickly discover what you are looking for, you have all your workspaces in view.

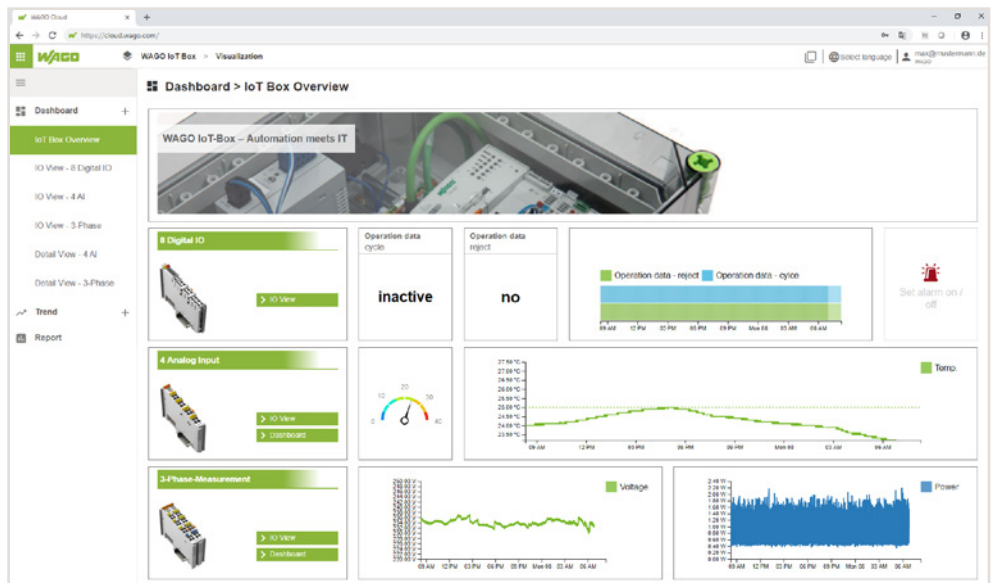
**Simple Application:**  
• Let us guide you in creating cloud projects.

**Relevant Functions:**  
• Only see the features that are immediately available.

**Controller Status Overview:**  
See your connected and disconnected controllers, as well as relevant connection details.



**Dashboard:**  
Create your own dashboard according to your needs and use graphics and trends.



## WAGO Cloud

1

### What kind of services can I use on the WAGO Cloud?

The WAGO Cloud is a universal industrial-strength data logger with data visualization. It allows customizable dashboards and analyses to be created quickly and easily in the cloud. Use interfaces via REST and CSV data export for further processing of data, or use them as a data supplier in order to perform detailed analyses in other systems, for example. Monitor controller statuses and receive notifications if specified limit values are exceeded.

### How can I use the functions?

Test the WAGO Cloud for 30 days with no commitment to see if it's right for you.

The cloud service is available online at <https://cloud.wago.com/>. After registering for free and linking to the WAGO controllers, you can get started in just a few minutes.

After that, you book licence points with a prepaid model, via our WAGO eShop for example, and simply redeem them in the cloud. Transparent billing management in the cloud allows you to fully monitor the current and anticipated scope of the functions used. When your licence points are almost used up, you receive a notice that you'll need to reload your points account soon.

You can find an overview of the functions we currently offer in the following table. For each individual function, there are various graduations, depending on how many components you need (e.g., number of connected controllers).

<b>Test Phase</b>	<ul style="list-style-type: none"> <li>• WAGO Cloud 30-day free trial (limited test points).</li> <li>• Points account may be exceeded after the test phase.</li> </ul>
-------------------	---

Functions			
<b>Data Management</b>	Data Package	<ul style="list-style-type: none"> <li>• Connect WAGO PFC Controller to the cloud.</li> <li>• Transfer data from the controller to the cloud.</li> <li>• Mount devices and data.</li> <li>• Visualize data.</li> </ul>	<ul style="list-style-type: none"> <li>• Basic package, necessary to use the WAGO Cloud</li> <li>• At least 50 license points/month</li> <li>• Volume-dependent, decreasing license point consumption</li> </ul>
	Restful API	<ul style="list-style-type: none"> <li>• Provide data for other cloud services and customer systems.</li> </ul>	<ul style="list-style-type: none"> <li>• Volume-dependent, decreasing license point consumption</li> </ul>
<b>Device Management</b>	Firmware & Application Update	<ul style="list-style-type: none"> <li>• Select/download firmware catalog.</li> <li>• Manage your own firmware application catalog.</li> <li>• Replace firmware on the device.</li> <li>• Install application updates.</li> </ul>	<ul style="list-style-type: none"> <li>• 1 license point/update</li> </ul>
	Remote Visu Access	<ul style="list-style-type: none"> <li>• Access local configurations and visualizations remotely (diagnostics, monitoring, remote maintenance).</li> </ul>	<ul style="list-style-type: none"> <li>• 10 license points/hour</li> </ul>
	User Management	<ul style="list-style-type: none"> <li>• In a customer area, up to 10 users have free access. More can be booked upon request.</li> </ul>	

Item Description	
	Item No.
WAGO Cloud; 100 license points	2759-1061/651-010
WAGO Cloud; 500 license points	2759-1061/651-050
WAGO Cloud; 1000 license points	2759-1061/651-100

Redeem license points at: <https://cloud.wago.com/>

## Cloud Connectivity via MQTT

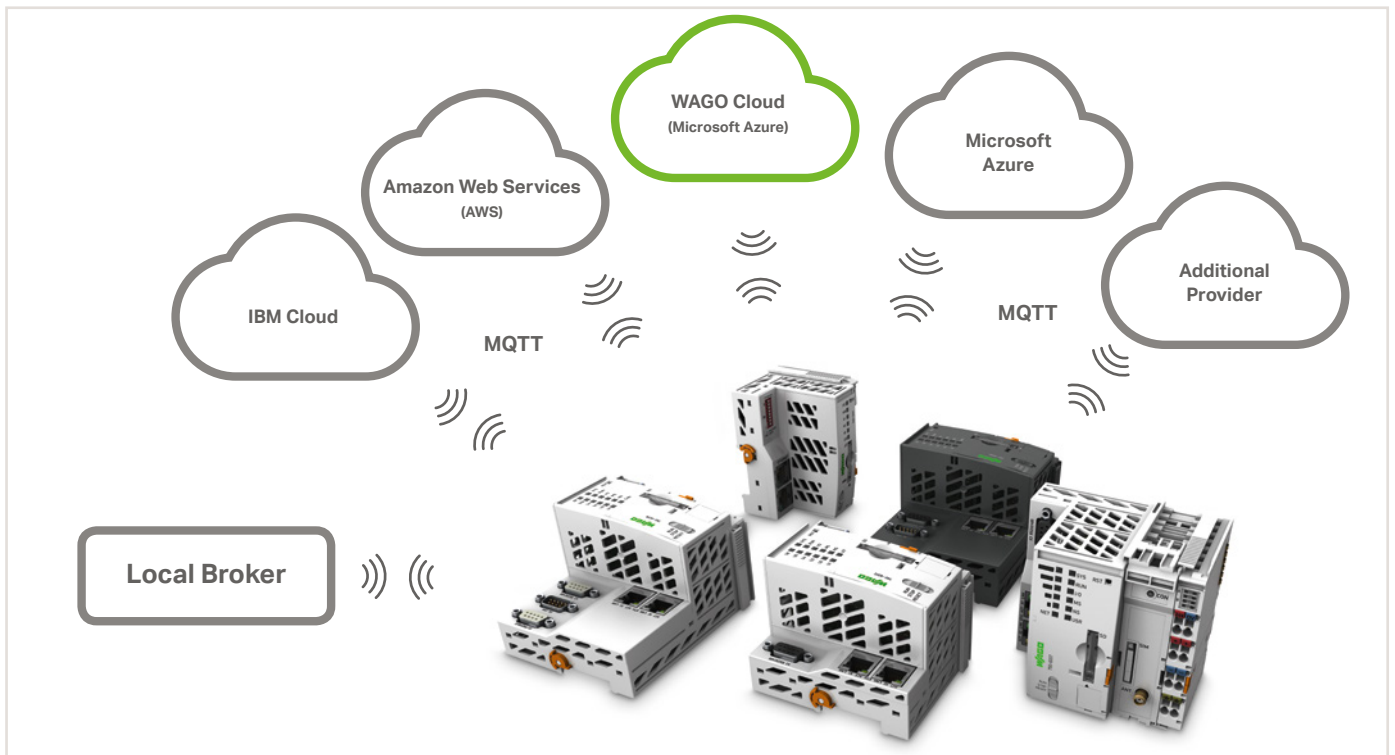
### Recording, digitizing and linking data profitably...

...this is the core concept behind Industry 4.0. The field level connection is established with the open WAGO-I/O-SYSTEM 750 or 750 XTR; the data is sent to the cloud or a local MQTT broker by a PFC Controller where it can be aggregated and used for analysis. This creates true added value for your company – be it for increasing the efficiency of in-house production, implementing energy management in buildings or developing additional end-customer services. Existing systems also become IoT-ready, making them sustainable into the future.

Communication between PFCs and cloud suppliers is conducted via the MQTT protocol and encrypted via TLS 1.2.

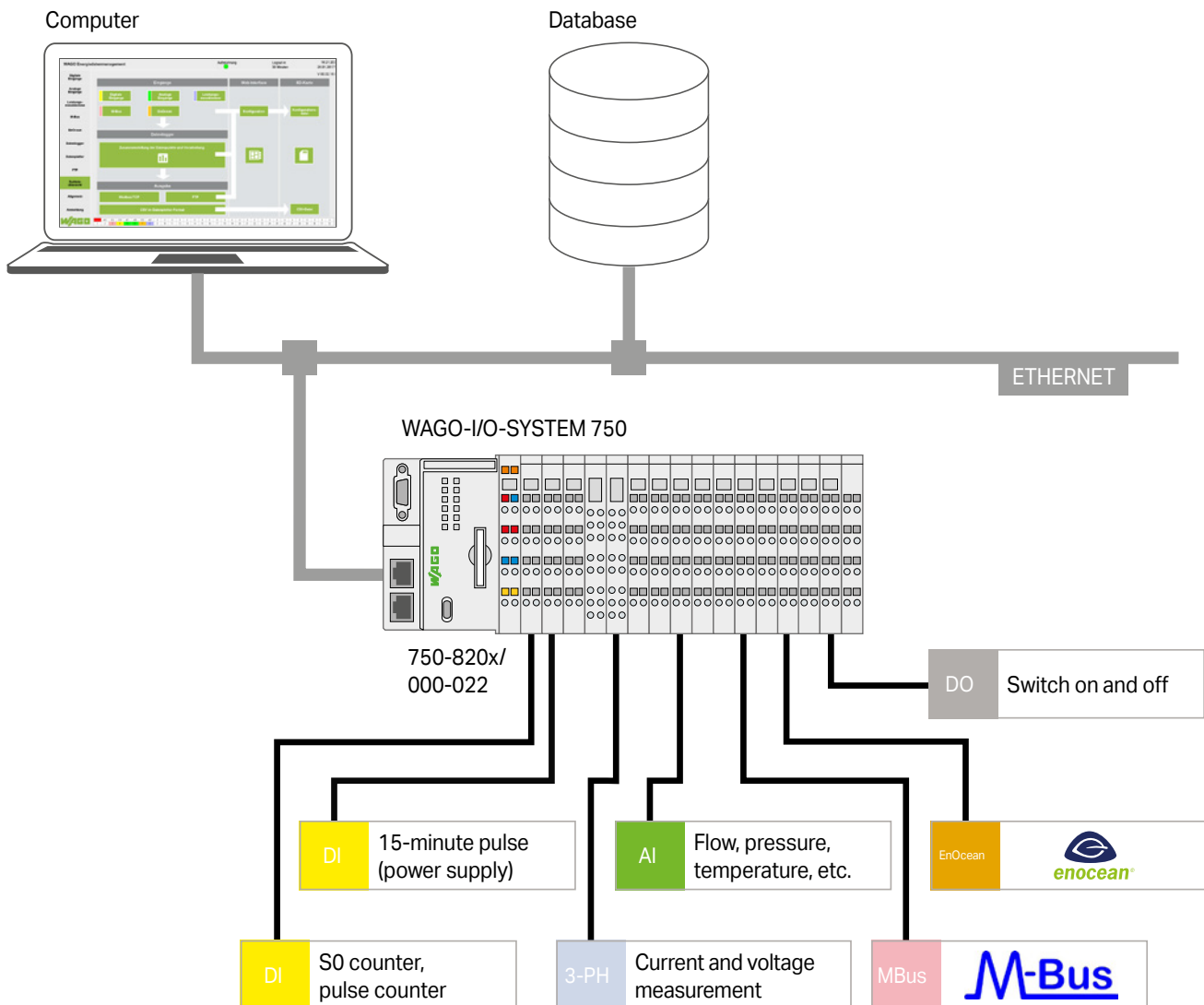
The cloud connection data is configured via Web-based Management (WBM). By default, *e!COCKPIT* contains appropriate libraries for defining the variables to transfer to the cloud in the IEC program. Thus the IEC programmer maintains complete control. Controller information, such as run/stop, connection status and device information can also be transferred to a cloud solution with cloud connectivity or distributed via MQTT broker.

With their wide variety of interfaces, the WAGO Controllers are the perfect foundation for an IoT gateway. They can collect numerous field signals, communicate in a large number of industrial protocols and even enable cloud connection of sensors and actuators that themselves lack a Web interface. Thanks to the standard MQTT protocol, it is possible to connect to cloud providers such as Microsoft Azure, Amazon Web Services or IBM Cloud or SAP Cloud. Of course, other MQTT brokers or solutions such as the WAGO Cloud can also be connected. Cloud connectivity is included by default with PFC Controller Firmware 11 and above, and the required library has been included in *e!COCKPIT* since Version 1.4.



Cloud connectivity is possible with all PFC100 and PFC200 Controllers.

# WAGO Energy Data Management



WAGO Energy Data Management seamlessly records, visualizes and manages energy data without any programming and can be upgraded at any time. The energy data management system provides energy flow monitoring via user-friendly Web visualization. The connected I/O modules (see table) are automatically detected and can be configured via user interface. In addition to energy-specific values like electrical currents or voltages, the networked WAGO Controller can record other measurement variables relevant for industrial and process technologies or building applications – for example, gas, heat, water, compressed air and temperature. With the integrated visualization tool, collected data is easily displayed and evaluated in various forms.

The data is transferred to higher level energy management software via Modbus TCP/IP or as a CSV file via FTPS. In addition, it is possible to store the history on an SD card integrated into the controller. Because it is so easy to integrate the versatile new WAGO solution into existing systems, increasing measurement point depth is also a simple matter.

WAGO Energy Data Management			
	Components	Item No.	Number of Modules (Max.)
Base unit	Energy Data Management – Controller		
	Controller PFC200; Energy data management application; 2 x ETHERNET; RS-232/-485	750-8202/000-022	1
	Controller PFC200; Energy data management application; 2 x ETHERNET; RS-232/-485; Mobile radio module	750-8207/000-022	1
	Energy Data Management – Software	Download: <a href="http://wago.com/applicationcontroller">wago.com/applicationcontroller</a>	1
	End Module	750-600	1
	Power Supply to I/O Node; 230 VAC/24 VDC; 2.5 A	787-1012	1
	Power Supply to I/O Node; 230 VAC/24 VDC; 2 A	787-1606	1
Recording real power pulse EVU	4-Channel Digital Input; 24 VDC; 3 ms	750-402	1
Button connection for starting and stopping the data logging	8-Channel Digital Input/Output; 24 VDC; 0.5 A	750-1506	1
Recording S0 and pulse counter	2 Up/Down Counters; 16 bits; 500 Hz	750-638	4
Switching of outputs via MODBUS Master	8-Channel Digital Output; 24 VDC; 0.5 A	750-530	1
3-Phase Power Measurement	3-Phase Power Measurement; 690 VAC 1 A	750-495	Total: 18
	3-Phase Power Measurement; 690 VAC 5 A	750-495/000-001	
	3-Phase Power Measurement; 690 VAC Rogowski coils	750-495/000-002	
Temperature, pressure, flow meters and other analog signals	2-Channel Analog Input; 0 ... 20 mA; Differential input	750-452	1
	8-Channel Analog Input; 0/4 ... 20 mA; Single-ended	750-496	2
	8-Channel Analog Input; 0 ... 10 VDC/±10 V; Single-ended	750-497	2
Resistance sensors	8-Channel Analog Input; Resistance measurement; Adjustable	750-451	2
Extension for connecting the M-Bus level converter	M-Bus Master	753-649	1
Extension for connecting the EnOcean Gateway	Serial Interface RS-232/-485	750-652	1
	EnOcean Receiver/Transmitter with RS-485 EVC Interface	2852-7101	1
Components for decentralized measurements	End Module for Bus Extension	750-627	1
	Coupler Module for Bus Extension	750-628	1 ... 10
	System Power Supply; 24 VDC	750-613	1 ... 10
	End Module	750-600	1 ... 10
	Switched-Mode Power Supply; 24 VDC/2.5 A	787-1012	1 ... 10



750-8202/000-022 or 750-8207/000-022



## Energy Data Management

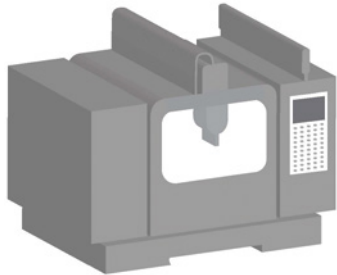
Combine a high-performance controller with software that automatically detects the different signals from connected meters and sensors – energy monitoring simple and flexible.

# Machine Data Collection with the digitalTAP™ Software, Powered by MTConnect

1

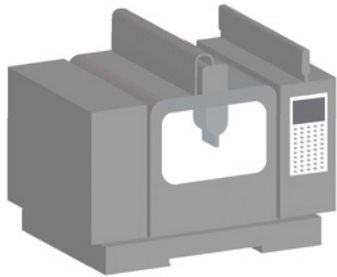
## MTConnect open Standard

Tools with MTConnect embedded:  
Adapter Agent embedded



Adapter  
/Agent

## Legacy Machine Tools



The Adapter bridges signals from the plant floor equipment with the Agent using Simple Hierarchical Data Representation (SHDR) format

Adapter

Agent

The Agent buffers the data from the Adapter and serves it to an application client in a standard XML schema or data dictionary that structures the information in a standardized format

Machine Data  
Collection  
Application

XML Data Stream

WAGO offers an economical solution for integrating the machine data of existing systems into higher-level analytic software applications. DigitalTAP™ from WAGO captures your machine's information and converts it into digital signals that can be used by analytic and data logger applications. The solution provides real-time device data in a standardized format for every machine type. This solution requires no programming. The user merely needs to configure the wired inputs via web visualization tool. Each input can be assigned a unique name individually with its own parameters, such as units and scaling range. These configuration parameters are stored automatically in the WAGO controller and are available immediately.

Through use of the open, licence-free MTConnect® standard, the machine information is formatted in a standardized table and uses proven Internet protocols for the data transport.



Machine Data Collection with MTConnect			
		Components	Item No.
Application Controller	Controller PFC100; FG0; 2 x ETHERNET		750-8101/000-010
	digitalTAP™ Application Software		Download: <a href="http://wago.com/applicationcontroller">wago.com/applicationcontroller</a>
Supported Modules	Digital Modules	8-Channel Digital Input; 24 VDC; 3 ms	750-430
		4-Channel Digital Input; 24 VDC; 3 ms; 2-wire connection	750-432
		4-Channel Digital Input; 24 VDC; 0.2 ms; 2-wire connection	750-433
		8-Channel Digital Input; 24 VDC; 3 ms; Low-side switching	750-436
		16-Channel Digital Input; 24 VDC; 3 ms	750-1405
		8-Channel Digital Output; 24 VDC; 0.5 A	750-530
	Analog Modules	2-Channel Analog Input; 0 ... 20 mA; Differential input	750-452
		2-Channel Analog Input; 4 ... 20 mA; Single-ended	750-466
		4-Channel Analog Input; 4 ... 20 mA; Single-ended	750-455
		8-Channel Analog Input; 0/4 ... 20 mA; Single-ended	750-496
		2-Channel Analog Input; 0 ... 10 VDC; Single-ended	750-467
		8-Channel Analog Input; 0 ... 10 VDC/±10 V; Single-ended	750-497
		4-Channel Analog Input; Resistance measurement; Adjustable	750-450
		8-Channel Analog Input; Resistance measurement; Adjustable	750-451
		2-Channel Analog Input; Thermocouple K; Diagnostics; Adjustable	750-469/003-000
		8-Channel Analog Input; Thermocouple; Adjustable	750-458
		3-Phase Power Measurement; 480 VAC 1 A	750-494
		Function and Technology Modules	2-Channel Vibration Velocity/Bearing Condition Monitoring VIB I/O Module
	Other Modules	End Module	750-600



750-8101/000-010



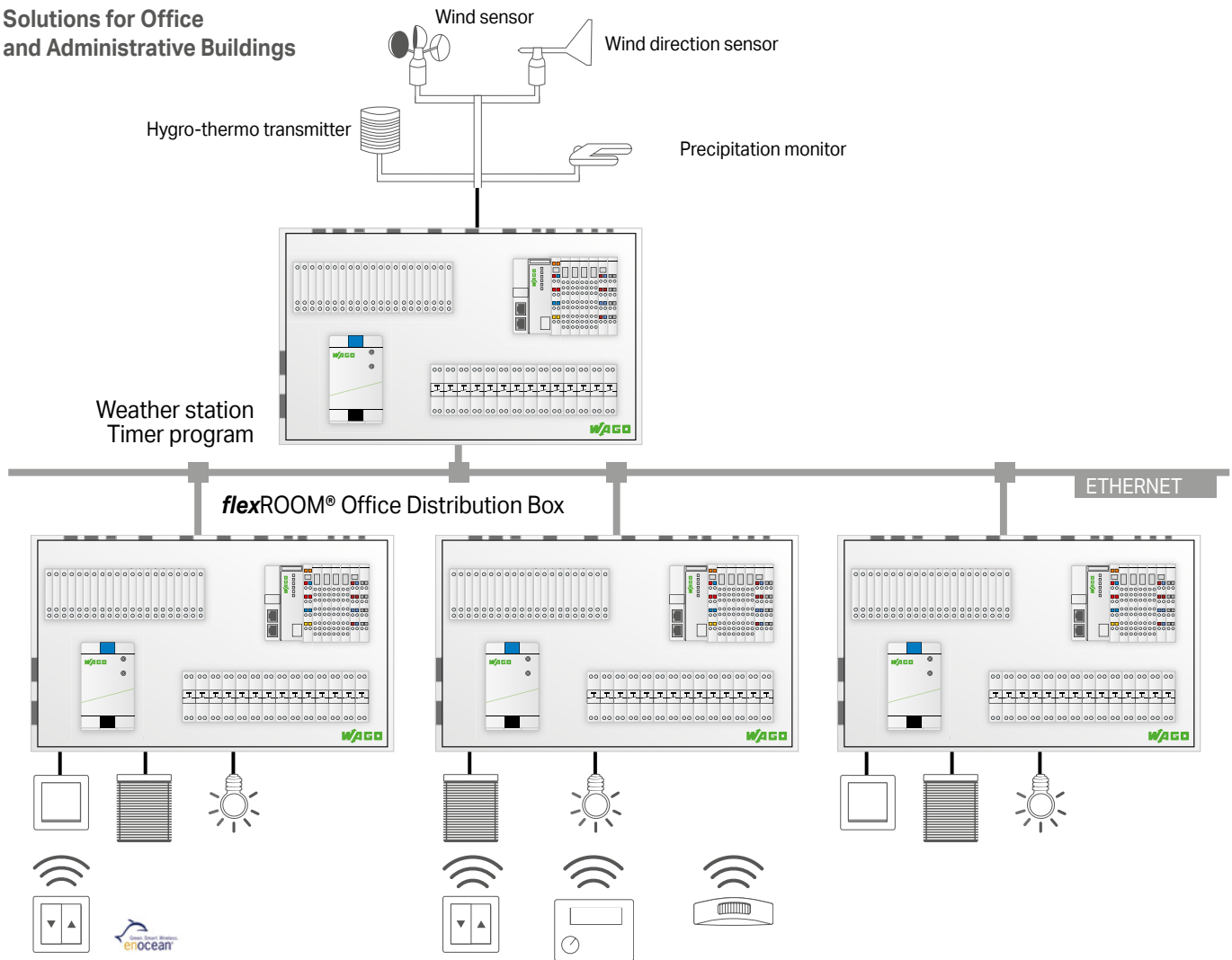
## MTConnect

Get started with the Smart Factory comfortably and efficiently with digitalTAP(tm) – Powered by MTConnect.

# Room Management with WAGO *flexROOM*®

## *flexROOM*®

### Solutions for Office and Administrative Buildings



*flexROOM*® is ideal for automating industrial and functional buildings (office buildings). This solution automates both lighting and sun protection, while performing single-room control (heating/cooling) for up to 24 room segments. A room segment is the smallest common denominator.

A wide range of 750/753 Series Digital Input/Output Modules are supported. The number of components can be planned and customized to meet individual requirements. For detailed information about supported hardware components, see the manual at [www.wago.com/flexROOM](http://www.wago.com/flexROOM).

Each WAGO *flexROOM*® Controller has a Web interface. Both the commissioning technician and end-user can configure the controls for each room via

Web browser, regardless of their location or distribution box. Entire floor plans (setting and deleting walls) and room parameter settings, such as lighting and shading groups, can be changed from the parameter interface. No additional software is required.

WAGO flexROOM®			
	Components	Item No.	
Application Controller	PFC200 Controller; FG1; 2 x ETHERNET, RS-232/-485 flexROOM® Application Software	750-8202/000-011 Download: <a href="http://wago.com/applicationcontroller">wago.com/applicationcontroller</a>	
Additional Modules (Examples)	16-Channel Digital Input; 24 VDC; 3 ms	750-1405	
	16-Channel Digital Output; 24 VDC; 0.5 A	750-1504	
	Serial Interface RS-232/-485	750-652	
	DALI Multi-Master	753-647	
	DALI Multi-Master DC/DC Converter	753-620	
	End Module	750-600	
DALI Accessories	DALI Sensors	WAGO DALI Multi-Sensor Kit • DALI Sensor Coupler • Eco-CI Kit • MULTI-3-CL Sensor	
		DALI Sensor Coupler	2851-8202
		WAGO DALI MSensor-02 5DPI 41rc (ceiling installation)	2851-8301
		WAGO DALI MSensor-02 5DPI 41w (box installation)	2851-8302
		WAGO DALI MSensor-02 5DPI 41rs (surface mounting)	2851-8303
	EnOcean Accessories	EnOcean Radio Transmitters	EnOcean easyfit PTM 250 2-Channel Lighting Control
2-Channel Blind Control			758-940/003-000
4-Channel Lighting Control			758-940/002-000
4-Channel Blind Control			758-940/004-000
Room Control Unit		SR04-P Room Control Unit, radio, wall, EnOcean	2852-7112
	SR06 LCD Room Control Unit, radio, in-wall, EnOcean, 2 buttons	2852-7113	
WINSTA® Accessories	Connector Set	Predefined Connector Sets	
	Couplers/Distribution Connectors	h-Distribution Connectors	
	Distribution Boxes	Distribution Connectors with Phase Selection	
	Connecting Cables	Pre-Assembled with Various Connectors Various Cable Types/Cross Sections	
	Tools	Operating Tools Wiring Tools	



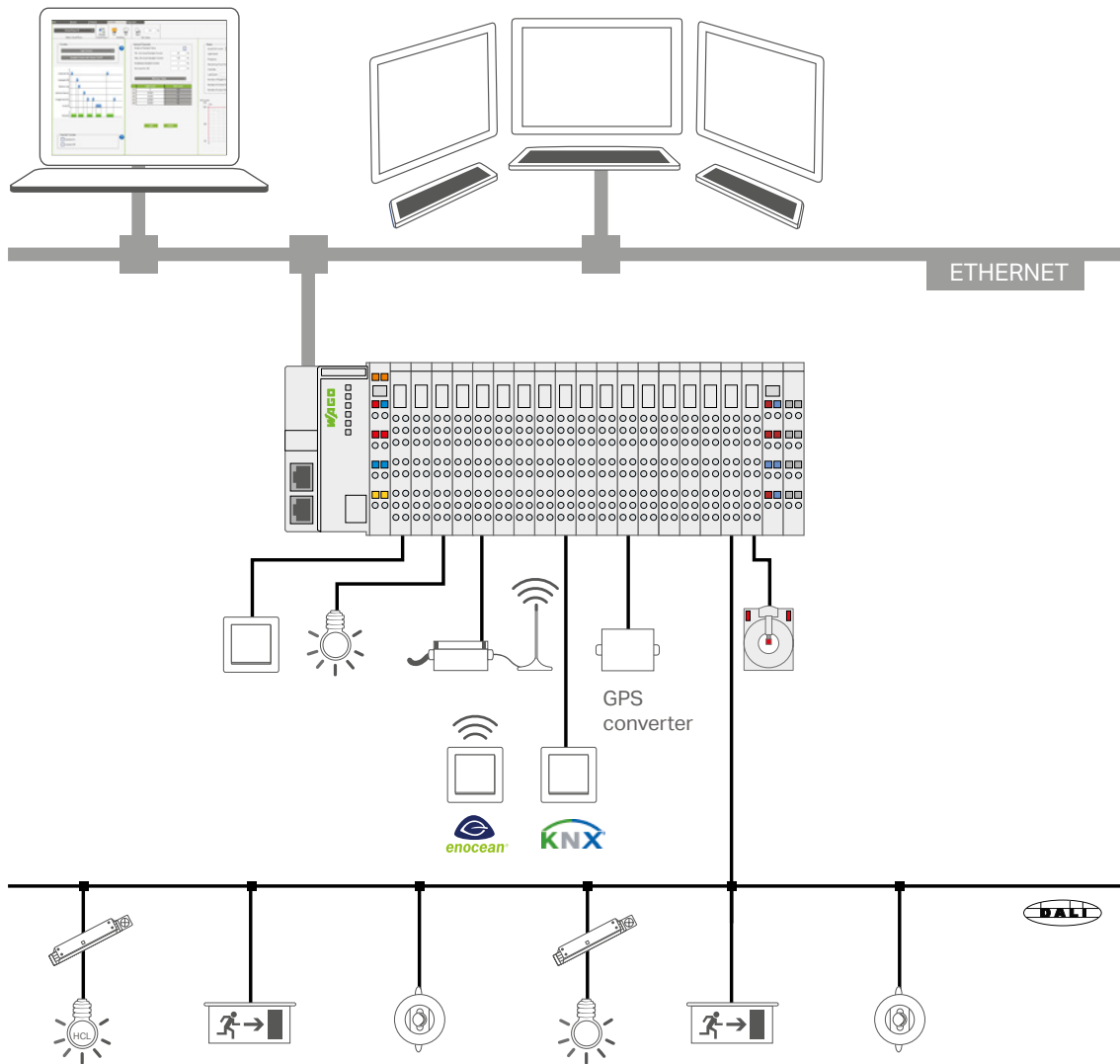
750-8202/000-011 or 750-8202/000-012



## Room Management

In order to use the full capability of the application controller, you need the flexROOM® Software. The software is available after registration. By registering, we make the latest version of the software available to you by e-mail and can help you with any questions at any time.

# WAGO Lighting Management



WAGO Lighting Management is a proven concept based on predefined hardware and preconfigured software, which greatly simplifies planning, commissioning and operation. The basic idea: WAGO Lighting Management is based on the different lighting requirements in warehouses and production facilities. For example, a production facility is divided into virtual rooms in which the light can be flexibly adapted. Each virtual room receives signals from sensors and actuators in order to automatically set the appropriate light intensity. By using the virtual rooms, conversions and room remodeling can be implemented quickly and simply via Web configuration.

WAGO Lighting Management			
	Components	Item No.	Note
Base unit	Lighting Management – Controllers		The controllers can communicate with each other.
	Controller PFC200; FG2; 2 x ETHERNET; RS-232/-485	750-8202/000-012	
	Lighting Management – Software	Free of charge	Download: wago.com/applicationcontroller
	DALI Multi-Master	753-647	In addition to 64 DALI actuators (ECGs), a DALI Multi-Master Module supports up to 16 DALI Multi-sensors (max. 64 sensor addresses); max. 10 DALI modules per base package.
	End Module	750-600	An end module must be snapped onto the assembly at the end of a fieldbus node.
	Power Supply to I/O Node	787-1012	24 VDC supply voltage for controllers and additional modules
	Power Supply to DALI Multi-Master	787-1007	Power supply to max. 5 DALI Multi-Master Modules
Extension for inputs/buttons	16-Channel Digital Input; 24 VDC; 3 ms	750-1405	For 1–16 light push-buttons/switch inputs; max. 4 extensions per base package
Extension for outputs/actuators	16-Channel Digital Output; 24 VDC; 0.5 A	750-1504	For 1–16 actuators/lamps/relays/ECG control; max. 2 extensions per base package
	Socket with Relay and Status; Display; 1 make contact; 24 VDC	788-357	Light switching via relay
Extension for EnOcean radio	Serial Interface RS-232/-485	750-652	Serial interface connects to STC65-RS485 EVC EnOcean Radio Transmitter/Receiver (for 1–64 rocker switches)
	EnOcean Receiver/Transmitter	2852-7101	EnOcean radio signal recording and transmission to the I/O node
	EnOcean Repeater	2852-7102	Extends the transmission range (for more planning information, visit the EnOcean website).
	Radio Transmitter; EnOcean easyfit PTM 250; 2-channel lighting control	758-940/001-000	1–2 or 1–4 signals; range of 30 meters in buildings to the radio receiver
	Radio Transmitter; EnOcean easyfit PTM 250; 4-channel lighting control	758-940/003-000	
Extension for external time request	Real-Time Clock Module	750-640	Time synchronization module, if no time server connection is possible
	GPS DCF Converter	2852-7901	Converter/external receiver for time synchronization
Extension for energy data measurement	3-Phase Power Measurement; 690 VAC	750-495/xxx-xxx	Pre-assembled terminal block assemblies for easy connection and short-circuiting of current transformers (current transformers, see Full Line Catalog Volume 4)
	Current and Voltage Connections	2007-8874, 2007-8877	
Extension for KNX buttons	KNX/EIB/TP1 Interface	753-646	Connects KNX buttons to the I/O node
Extension for sensors	DALI Multi-Sensor Kit	2851-8201	Brightness measurement and motion sensor: kit connects to a DALI bus system
	DALI Sensor Coupler	2851-8202	Sensor coupler for connecting MULTI-3-CI sensors to DALI Max. 16 DALI sensor couplers per DALI Multi Master Module (753-647)
	DALI HIGHBAY ADAPTER + HIGH BAY	2852-7207, 2852-7201	Brightness measurement and motion sensor for large installation heights (3–13 meters)
	DALI HIGHBAY ADAPTER + VISION	2852-7207, 2852-7202	Motion sensor for large areas, open offices, hallways or warehouses
	DALI LS/PD LI	2852-7203	Motion sensor for office lighting (1 ... 5 meters)
	DALI Sensor Coupler HF LS LI + Radar Sensor HF LS LI 4p4c Connecting Cable, 50 cm,	2852-7205 2852-7206 2852-7208	Light and recessed ceiling sensor: combined daylight and motion detection, motion detection via radar
	DALI XC	2852-7301	Push-button coupler connects 4 conventional push-buttons to DALI.
	DALI Sensor Coupler E	2852-7204	Sensor coupler connects standard sensors to DALI.



750-8202/000-012



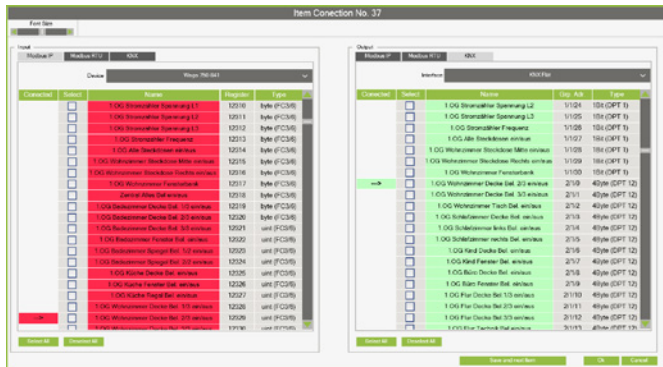
## Lighting Management

Using a combination of predefined hardware and user-friendly software, WAGO Lighting Management facilitates the design and commissioning of new lighting systems while providing numerous advantages for their operation.

# WAGO Gateway Application

1

With the new WAGO Gateway Application, it is possible to implement information exchange between different bus systems. This is supported by a user-friendly interface, so no programming is necessary – nothing but configuring connections.

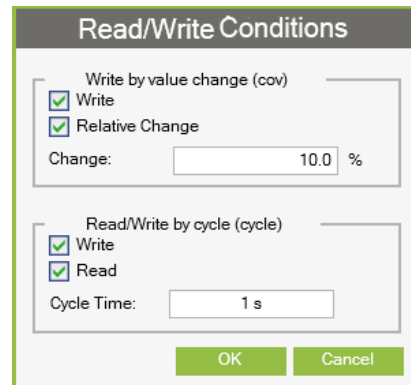


### Advantages:

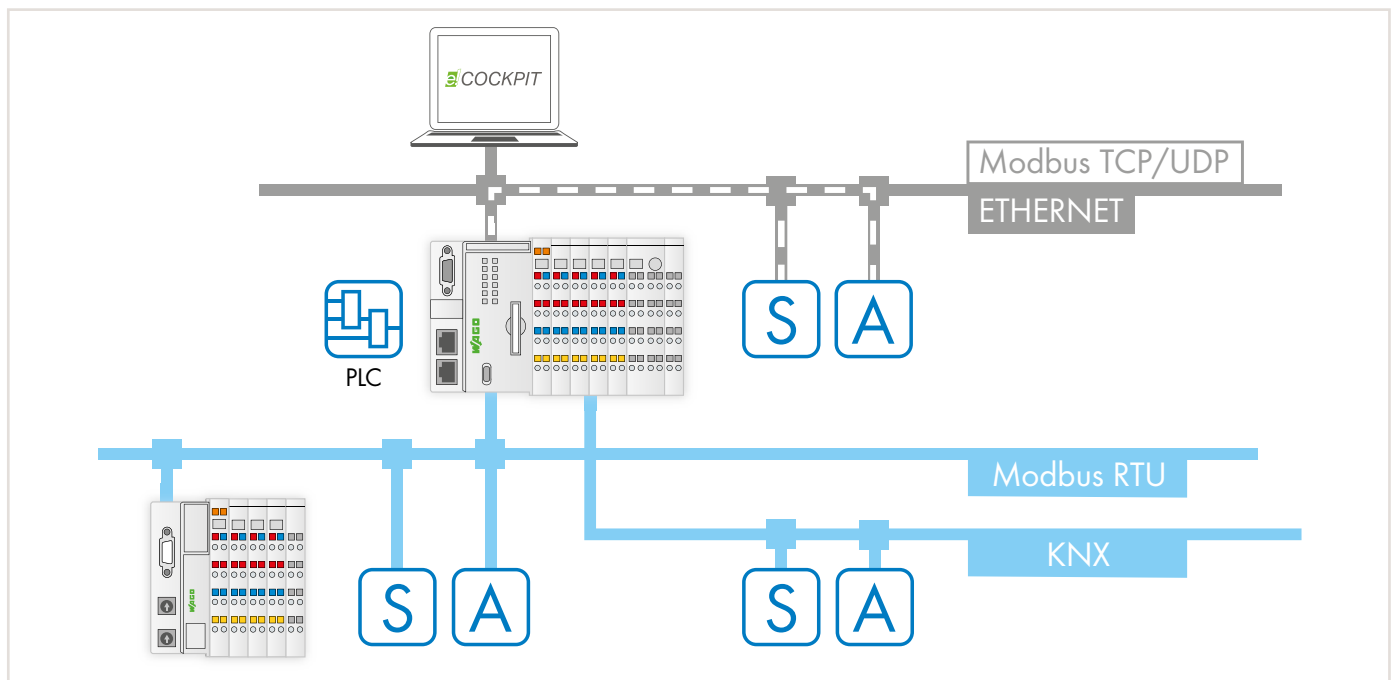
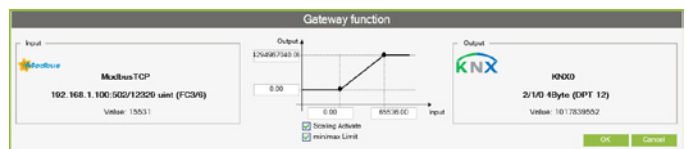
- Exchange of information between the bus systems:
  - Modbus TCP
  - Modbus UDP
  - Modbus RTU
  - KNX
- Commissioning time reduced through interface-supported configuration instead of programming
- Easily manage up to 255 KNX data points per KNX module via ETS import and export

### Function in Detail:

- Automatic detection of station structure
- Display of the available interfaces
- Creation of data points
- Import/export of ETS files (KNX)
- Linking of data points
- Conditional reading/writing



- Functional coupling

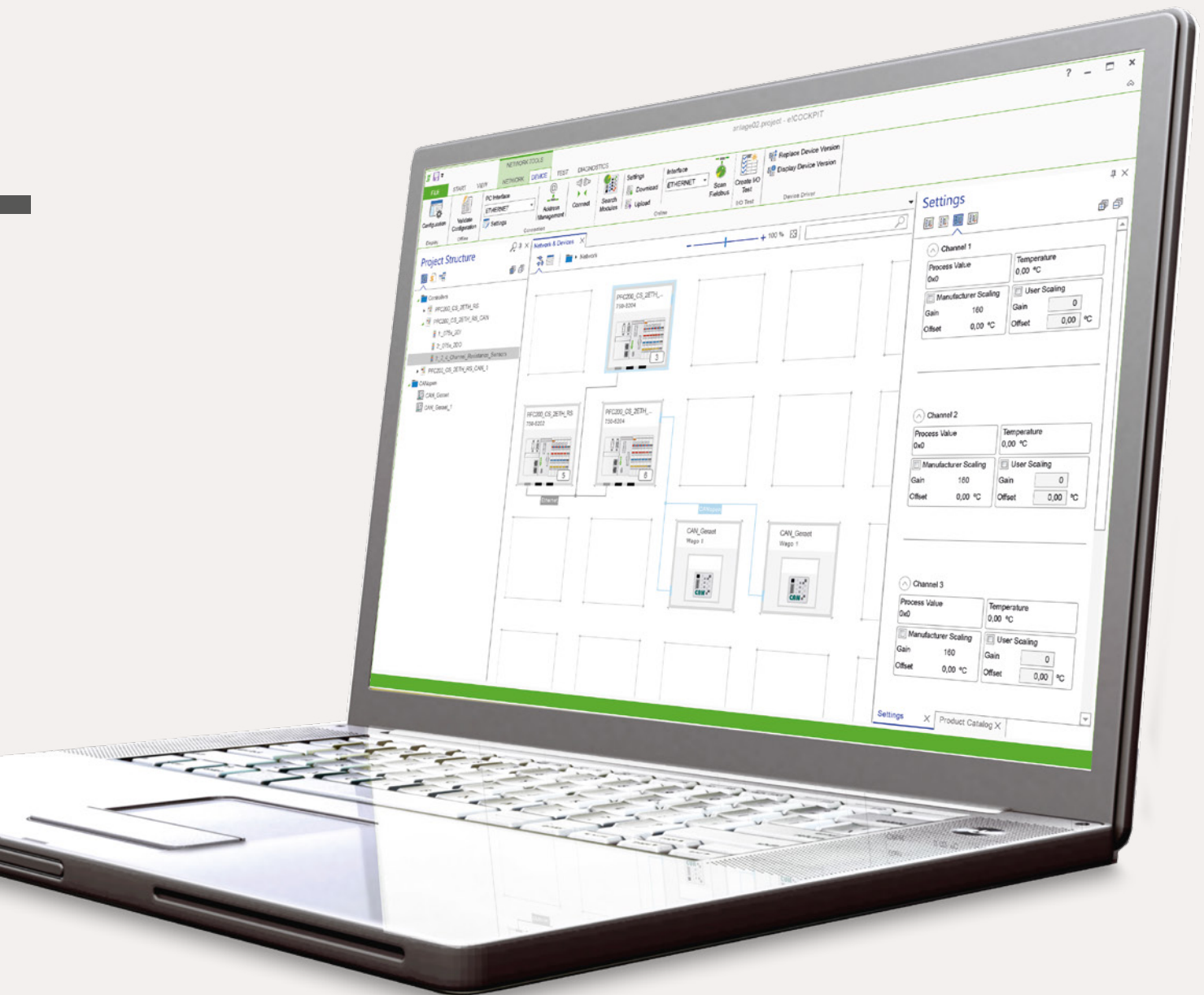


Item Description	Item No.
WAGO Gateway Application	Download

Delivery type	Closed Application Download at <a href="http://www.wago.com">www.wago.com</a>
Compatible Controller	750-8212
PFC200; G2; 2ETH RS	

You can find detailed information on the controllers in Section 4.1.





# Software

## Engineering Software

- PC-based software
- Customized tools for every automation task

## Runtime Software

- Standard machine component
- Comprehensive, tested software modules for control, regulation, operation & monitoring

## Mobile Software (Apps)

- Machine operation and monitoring via tablet and smartphone

## Solutions

- Cloud solutions
- Reusable, customizable software applications



## Software

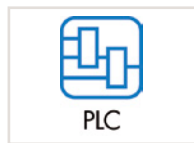
### Engineering Software, Runtime Software and Mobile Software



		Page
<b>General Product Information</b>		24

#### Engineering Software

	Description	Item No.	
Designing and marking	<i>smart</i> DATA Engineering	Online	
Programming and configuration software	<i>e!</i> COCKPIT	2759-0101	26
	Add On <i>e!</i> COCKPIT UML	2759-402/1420-1000	28
	<i>e!</i> COCKPIT Static Analysis	2759-403/1420-1000	29
	<i>e!</i> COCKPIT Profiler	2759-404/1420-1000	30
	WAGO-I/O-PRO	759-333	32
	WAGO-I/O-CHECK	759-302	33
	IEC 60870/IEC 61850 Configurator	Download	34
	DNP3 Configurator	Download	36
	SMI Configurator	Download	37
	BACnet Configurator	Download	38
DALI Configurator	Download	39	
LON® Configurator	Download	40	
Plug-ins	Device- and Industry-Specific Configurators		
	WAGO ETS Plug-In	Download	41



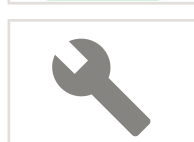
#### Runtime Software

Libraries	<i>e!</i> COCKPIT (based on CODESYS V3)	Download	42
	WAGO-I/O-PRO (based on CODESYS V2.3)	Download	43
<i>e!</i> RUNTIME	EtherCAT Master 300, single license	2759-263/210-1000	45



#### Mobile Software (Apps)

WAGO WebVisu App	Download	46
------------------	----------	----



#### Accessories

Configuration Cable, USB Communication Cable, <i>Bluetooth</i> ® Adapter	48
--	----

## Software

### General Product Information

#### Software Factors into Success

Projects in production, process and building automation are characterized by shorter and shorter implementation times, ever more complex structures and the increasing role of software as part of the overall solution. In fact, software is becoming an essential factor that influences the success of a project.

Engineering software is used for both machine and system development, as well as the implementation of building automation projects. Runtime software controls the devices at operating time.

#### Customized Software Tools

Significant challenges must be overcome to develop, operate and maintain modern machines and systems, as well as program, configure and commission building automation applications. Customized software tools are available as needed for every task – embedded within integrated engineering processes or as stand-alone tools for a set of dedicated functions.

#### CODESYS as an Integrated Environment



All WAGO Controllers are equipped with the high-performing CODESYS industry-standard development environment. This enables software development in the IEC 61131-3 PLC programming languages (ST, FBD, LD, IL, SFC and CFC). As a trusted programming environment, CODESYS guides developers, enabling them to reuse and further develop existing projects without relearning software. This means that modern paradigms are available, such as Object-Oriented Programming (OOP) and modern visualization technologies.

#### Pre-Made Software Solutions

Pre-made software solutions and applications simplify automation. Such solutions involve reusable software that can be used for a specific application by making simple adjustments. This approach saves time and money.

Pre-made software solutions can be found in Section 1.

#### Open to Proven Standards



The software is open to well-established standards, making it an investment in the future. The software supports all prominent fieldbuses, for example. This allows WAGO components to be seamlessly integrated into engineering software via standardized device description files. In addition, connecting controllers to fieldbus systems via WAGO Engineering Software is incredibly simple, opening up all the advantages of existing field devices.

Finally, WAGO Software is based on modern IT standards and development methods for long-term viability.

#### Extensive Import and Export Functionality



The software tools demonstrate an impressive ability to exchange project data with the external software tools involved in the development process – preventing costly, error-prone double entry.

#### Industry-Specific Configurators



Whether industry, process or building automation, every sector and industry has specific requirements. Therefore, plug-ins specifically customized for the needs of individual industries are available in addition to the common software base. For example, these plug-ins can be used to measure energy or easily configure a DALI network.

#### Advantages:

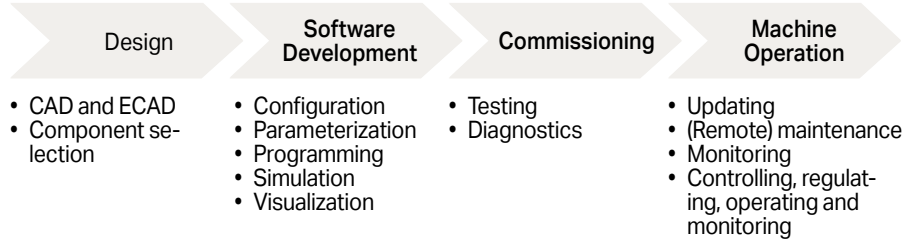
- Customized software for every automation task
- Extensive import functions from external design tools
- Plug-ins for industry-specific development environments
- Comprehensive software solutions for various industries
- Simple and secure licensing

# Software

## General Product Information

### Software for Mechanical Engineering

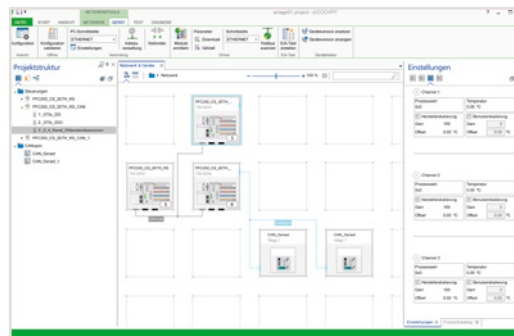
Software is used in every phase of machine and system automation – from design to successful machine operation.



### Engineering Software

Quickly implementing complex machine functions is critical in modern mechanical engineering applications. PC-based engineering software supports all development activities. The focus is on simple configuration, timely programming and efficient commissioning of automation network components.

Engineering tools are typically not permanently linked to the machine – they only communicate with the machine during startup and maintenance.

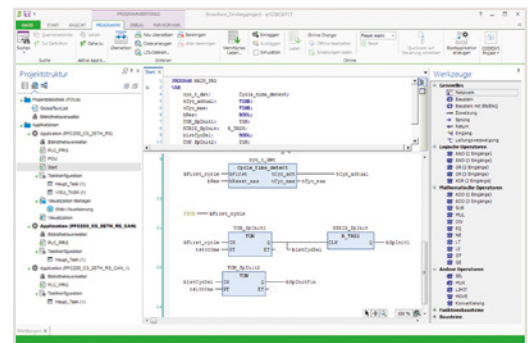


**COCKPIT**

### Runtime Software

The machine is controlled by runtime software that determines behavior, while enabling both operation and current status monitoring for the user. It also transmits operating data to higher-level systems. With comprehensive, tried-and-tested software function blocks (IEC libraries), development goals are reached more quickly.

Unlike engineering software, runtime software operates continuously – it is a part of the machine and ensures correct operation.



### Mobile Software (Apps)

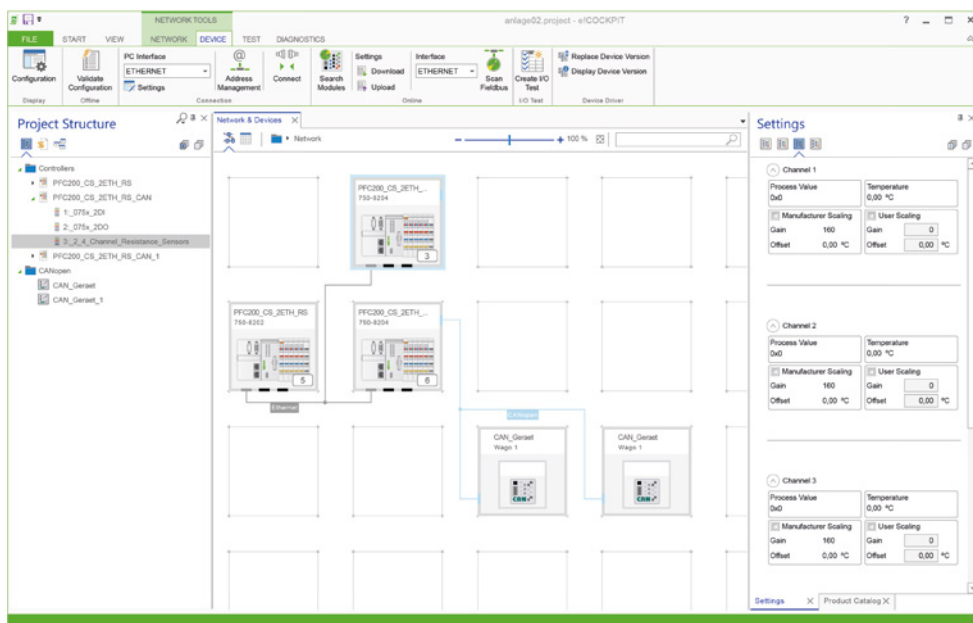
Software on mobile devices offers productivity advantages in an industrial environment as well. This integration enables users to quickly and easily operate and monitor automation processes via smartphone or tablet – from virtually anywhere.

Mobile software typically communicates only with the machine's controller for a specific application.



# e!COCKPIT Engineering Software Based on CODESYS V3

2



e!COCKPIT automation software for faster machine and system startup: WAGO's new engineering software shortens development time for automation projects while impressing with a modern and clearly laid out user interface. At the software's core is CODESYS V3 for simple and versatile creation of applications.

WAGO set out to fulfill these exact requirements by developing its own engineering software: e!COCKPIT. This integrated development environment supports every automation task, from hardware configuration, programming, simulation and visualization up to commissioning – all in one software package.

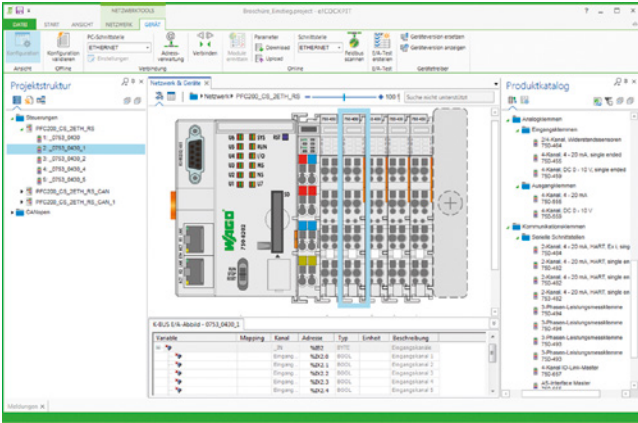
Ensuring a project's long-term viability through sustainable cost savings hinges on a user's ability to quickly adapt to new software that offers a high degree of reusability.

Use the programming tool to cover all important automation bases while simultaneously engineering particularly complex projects quickly and easily.

e!COCKPIT					
License Type	Number of PCs	Item No.	Order Text		
Workplace license	2	2759-0101/1110-2002	e!COCKPIT; Workstation license	Can be installed on up to two PCs (e.g., notebook & desktop)	
Multi-user license	5	2759-0101/1110-2005	e!COCKPIT; Multi-user license; 5	Multiple installations up to specified number	
Multi-user license	10	2759-0101/1110-2010	e!COCKPIT; Multi-user license; 10		
Multi-user license	15	2759-0101/1110-2015	e!COCKPIT; Multi-user license; 15		
Multi-user license	20	2759-0101/1110-2020	e!COCKPIT; Multi-user license; 20		
Site license	unlimited	2759-0101/1110-3000	e!COCKPIT; Site license	Unlimited installations at a company location	
Buy-out license	unlimited	2759-0101/1110-4000	e!COCKPIT; Buy-out license	Unlimited installations within a company at all locations in a country; in addition, the software may be used in company products that contain WAGO's automation technology to form a functional unit.	

Supported operating systems	Windows 7 (32- and 64-bit), Windows 8, Windows 8.1 (32- and 64-bit), Windows 10
<b>System Requirements</b>	
Processor	Dual-core
Memory	4 GB
Hard disk space	10 GB
Graphics resolution	1,366 x 768 px
Supported devices	Controllers based on CODESYS V3, I/O modules (750/753)
Supported fieldbuses	CANopen; Modbus TCP/UDP; Modbus RTU; PROFIBUS
Supported device descriptions	DTP; EDS; GSD
Connectivity	TCP; USB; OPC; CODESYS network variables; CODESYS DataServer
Programming languages per IEC 61131-3	ST; LD; FBD; IL; FC; CFC
Import/export formats	CODESYS V3 project files (*.project)
Delivery type	Installation file (download)
For data sheet and further information, see:	<a href="http://wago.com/ecockpit">wago.com/ecockpit</a>

Internet connection may be required for license activation.  
Windows® is a registered trademark of Microsoft Corporation.



### Configuration and Parameterization

The integrated e!COCKPIT configurators provide modern operating tools and workspaces, such as:

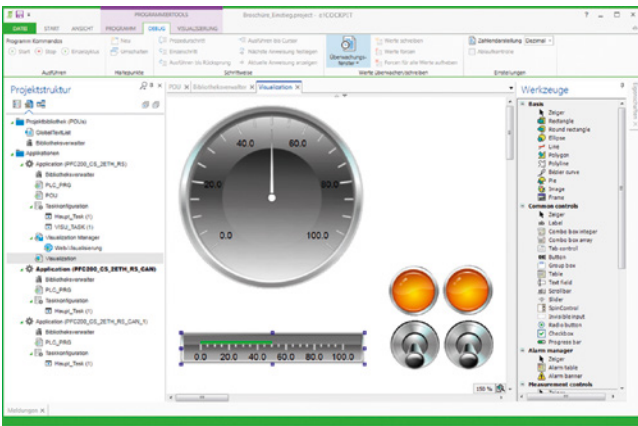
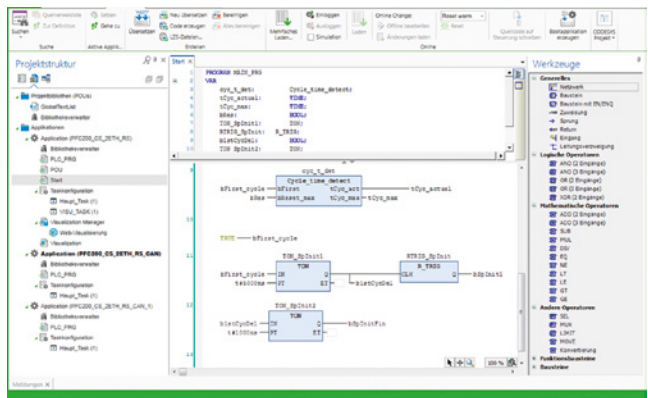
Examples:

- Graphical network topology: Complex relationships between network devices and their current states can be identified easily and intuitively.
- Drag & Drop: Simplifies device interaction.
- Copy & Paste: Individual devices or whole network branches can be duplicated quickly.
- Batch processing: Parameter values are set simultaneously for several devices.

### Programming

e!COCKPIT offers multiple software development options:

- IEC 61131-3 PLC programming languages: Structured Text (ST), Ladder Diagram (LD), Function Block Diagram (FBD), Instruction List (IL), Sequential Function Chart (SFC), Continuous Function Chart (CFC)
- For flexibility, all programming languages can be combined with one another.
- Created programs can be easily debugged on the engineering PC via simulation.
- New paradigms such as object-oriented programming are included.



### Visualization

Advanced user interfaces for operating and monitoring machines are standard. Today, HMI-based design is a critical factor that influences the purchase of an entire automation line. e!COCKPIT employs Drag & Drop to streamline the design of modern user interfaces. The integrated visualization editor provides:

- Access to IEC program variables
- Closed simulation of HMI and PLC programs on the engineering PC
- Guaranteed language independence via Unicode character set
- Current standards such as HTML 5 or CSS

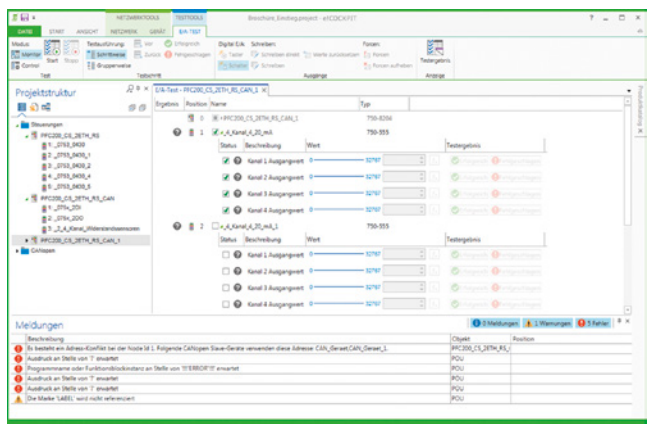
### Diagnostics

Being acutely aware of the automation network's current status is an absolute must for the rapid detection and elimination of errors – be it during development in the office or directly on the machine during commissioning. e!COCKPIT provides comprehensive diagnostic capabilities:

Individual views, for example, always display the controllers' status information both graphically and in tabular form

To keep the project on time, error messages are transmitted directly and clearly.

The structured wiring test function systematically identifies wiring errors.



# e!COCKPIT UML Software Modeling in UML

UML (Unified Modeling Language) is a graphical language for specifying, designing and documenting object-oriented software. It clearly facilitates discussions between programming and other disciplines within system development. The e!COCKPIT UML add-on extends the e!COCKPIT Engineering Software with two languages of the "Unified Modeling Language": the class diagram and the status diagram.

2

### Advantages:

- Improved readability of the program code via clear class and behavior diagrams in standardized form
- Reduce programming errors by generating program code from UML diagrams
- Easier debugging through online data in the state diagram

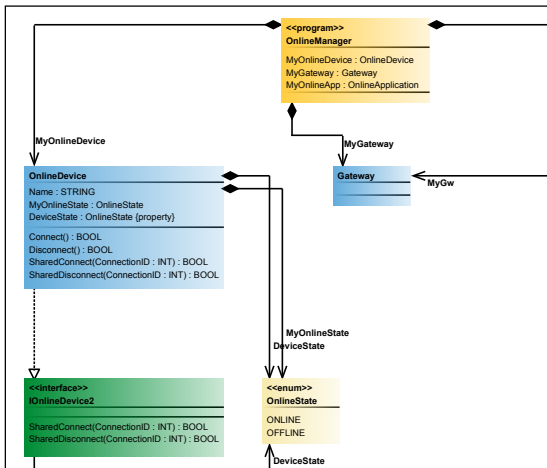
### Class Diagram:

The class diagram belongs to the group of UML structure diagrams. With the additional graphic editor, the object-oriented structure of e!COCKPIT projects can be mapped or designed. The various object classes (e.g., function blocks or interfaces), including the variables and methods used in them, and their relationships are clearly displayed.

The existing project structure can be imported directly from the device structure when creating a class diagram. However, a project structure can also be rebuilt using the following available class and relationship elements:

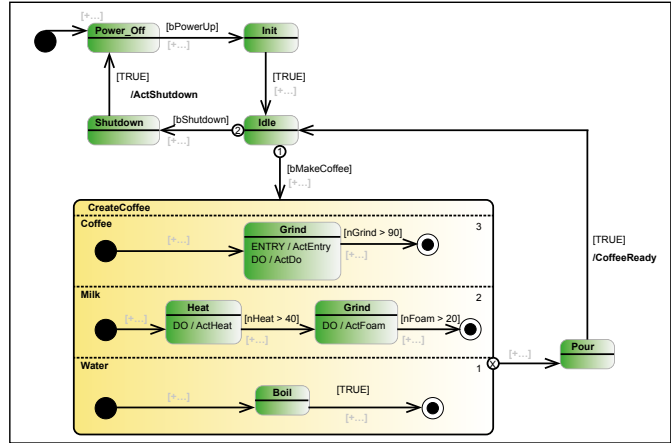
- Class (POU)
- Interface
- Variable declaration
- Property
- Method
- Generalization
- Realization relationship
- Association
- Composition

New objects in the class diagram editor are automatically inserted into the device structure.



### State Diagram:

The state diagram belongs to the group of UML behavior diagrams. It is a graphical language for specifying and designing the sequence of event-discrete systems. Unlike with the class diagram, executable application code is generated when compiling a state diagram.



The state diagram editor includes a selection of step and transition elements:

- Start state
- End state
- State
- Composite state
- Junction/connection
- Selection
- Transition
- End transition
- Exception transition

When the application is running, the status diagram is switched according to the clock cycle. In addition, an independent switching behavior can be realized via cyclic internal state diagrams. In online mode, the state diagram is animated so that the current status of the process can be tracked at any time.

Item Description	Item No.
e!COCKPIT UML; Single-user license	2759-402/1420-1000

Minimum e!COCKPIT version	V1.3.0
Hard disk space	20 MB
Delivery type	Installation file (download)
Data sheet and further information, see:	<a href="http://wago.com/2759-402/1420-1000">wago.com/2759-402/1420-1000</a>

Single license allows installation on one computer.

Internet connection may be required for license activation.

# e!COCKPIT Static Analysis Static Code Analysis

In addition to the compiler check, the *e!COCKPIT* Static Analysis add-on checks the source code based on defined rules and naming conventions. This add-on displays potential development problems, allowing errors to be detected and corrected before field testing. More than 100 partly parameterizable rules have already been implemented that can be combined into individual rule sets. The add-on functions are seamlessly integrated into the *e!COCKPIT* development environment.



### Advantages:

- Avoid errors during program creation
- Save time-consuming troubleshooting during application development
- Ensure that the program code conforms to the defined rules and is easily readable

### Main Functions:

- Check the application explicitly via menu command
- Alternatively: automatic verification during code generation
- Control pre-processor instructions, and determine which parts of the code will be analyzed

### Rules and Naming Conventions:

Within the *e!COCKPIT* project settings, a standard set of programming rules and naming conventions can be configured in the standard version:

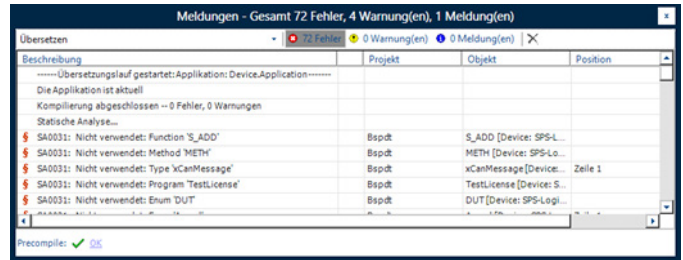
- Unused variables
- Overlapping memory areas
- Simultaneous access
- Multiple write access to output
- Multiple use of the name

Additionally, the following analytics can be performed with *e!COCKPIT* Static Analysis:

- Discover unreachable parts of the code
- Find empty objects
- Find empty instructions
- Find useless declarations
- Conversions
- Write access to input variables
- Rules for operators
- Rules for FOR and CASE instructions
- Strict testing of IEC rules

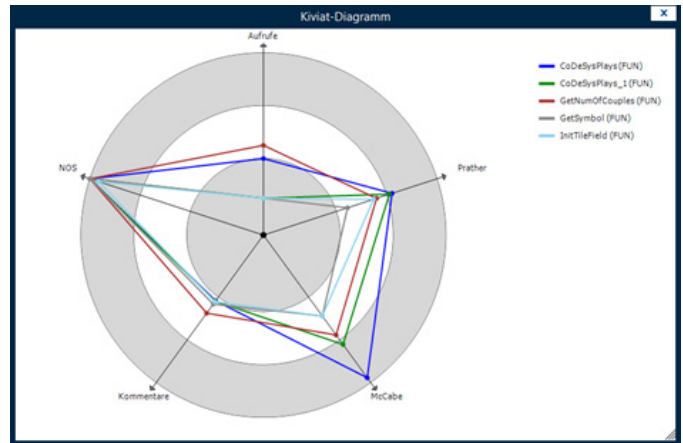
### Result of the Analysis:

The result of the analysis is displayed in the message window. Each violation has a unique number and can be uniquely associated with the configured rules and naming conventions.



### Metrics:

Various metrics, such as the number of code lines, memory consumption or the evaluation of software complexity, as well as the upper and lower limits to be observed, can be configured for evaluation of the code quality. The results of the applied metrics can be displayed in tabular and graphical form as a Kiviat diagram.



Item Description	Item No.
e!COCKPIT Static Analysis; Single License	2759-403/1420-1000

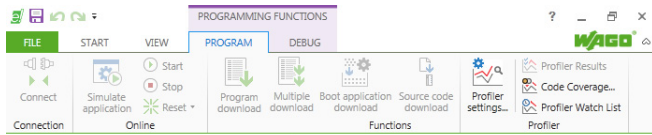
Minimum e!COCKPIT version	V1.4.0
Hard disk space	30 MB
Delivery type	Installation file (download)
Data sheet and further information, see:	<a href="http://wago.com/2759-403/1420-1000">wago.com/2759-403/1420-1000</a>

Single license allows installation on one computer.

Internet connection may be required for license activation.

## e!COCKPIT Profiler Runtime Behavior Analysis

The e!COCKPIT Profiler add-on allows programmers and application developers to measure and evaluate the processing times and code coverage of different blocks in an IEC 61131-3 application at an early stage. This add-on can be seamlessly integrated into the e!COCKPIT Engineering Software. Measurement may be performed parallel to the application development in the standard development environment.



### Advantages:

- Measure both machine code's runtime behavior and code coverage right at the beginning of the development phase
- Early detection of runtime problems
- Identify both time-consuming program parts and unused programming blocks
- Overall and individual measurement of all application blocks
- Identify the code efficiency by comparing historical and current measurements
- Increase the software quality

### Main Functions:

- Implicit binary code extension during translation, without changing the program code of a project
- Dynamic measurement via code instrumentation at each function entry and exit
- Only during measurement: temporary code enlargement and runtime extension of 10 to 50%
- Measurement start via variable or command
- Overview of the measurement results in the development environment

### Functions:

- Control the runtime measurement via freely selectable Boolean variable
- Measure the runtime of individual programming blocks and function block instances within the "profiler watch list"
- Measure the percentage of missed instructions per block via code coverage
- Measurement results show the time-critical path

### Setting Options:

- Select the task to be measured
- Select the unit base (tick, milliseconds or microseconds)
- Define the memory size required for the measurement
- Adjust the measurement behavior (next or maximum cycle)
- Select the calls to be measured in the monitoring list
- Select the program blocks to be measured to determine the code coverage

### Detailed Results:

- Percentage of time spent in the call
- Total time spent in call
- Average time of all POU calls in a single cycle
- Minimum and maximum processing time over multiple cycles
- Number of calls
- Time spent for each call
- Standard deviation of average measured time
- Percentage of the iterated code

### Display the Results as:

- Summary table
- Call tree (time- or process-oriented)
- Tables
- Watch list

100,00 %	MAINTASK	246,344 µs	1 Call
99,99 %	PLC_PRG (PRG)	246,324 µs	1 Call
95,34 %	CoDeSysPlays (FUN)	234,876 µs	2 Calls • Avg: 117,438 µs Min: 9
76,85 %	GetNumOfCouples (FUN)	189,324 µs	485 Calls • Avg: 0,390
35,34 %	SelectableTile (FUN)	87,059 µs	51526 Calls • Avg: 0,002
6,20 %	SelectableTile (FUN)	15,265 µs	9056 Calls • Avg: 0,002 µs Min: 0
0,60 %	TILEFIELD_TYPE.FB_INIT	1,472 µs	2 Calls • Avg: 0,736 µs Min: 0
0,59 %	STF_ENTRY.FB_INIT	1,443 µs	200 Calls • Avg: 0,007 µs Min: 0
3,93 %	CoDeSysPlays_1 (FUN)	9,676 µs	1 Call

Item Description	Item No.
e!COCKPIT Profiler, Single License	2759-404/1420-1000

Single license allows installation on one computer.

Minimum e!COCKPIT version	V1.4.0
Hard disk space	30 MB
Delivery type	Installation file (download)
Data sheet and further information, see:	<a href="http://wago.com/2759-404/1420-1000">wago.com/2759-404/1420-1000</a>

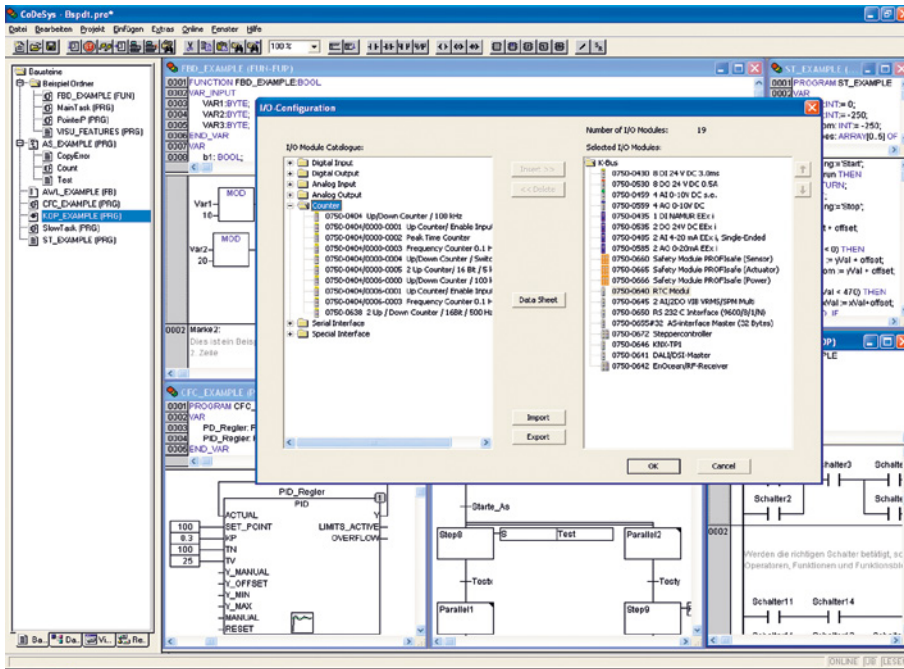
Internet connection may be required for license activation.



2

# WAGO-I/O-PRO Engineering Software Based on CODESYS V2.3

2



WAGO-I/O-PRO is a programming and visualization tool for control programs. This software is used to develop PLC applications for WAGO-I/O-SYSTEM 750 Controllers.

WAGO-I/O-PRO runs in line with the IEC 61131-3 standard, which specifies the requirements for a programming system. The IL, SFC, LD, FBD and ST programming languages are supported. The optimal programming language can be chosen for each application.

With extensive programming functions, the software readily meets the increasing requirements of control program development (e.g., reusability and modularization).

- Efficiently translate between programming languages
- Automatic variable declaration
- Library management

Integrated test and diagnostic functions also streamline and accelerate the implementation of processes for PLC projects.

- Online status display using the program code
- Offline simulation
- Integrated process visualization
- Record and graphically display project variables

WAGO-I/O-PRO also offers the option of programming your existing products from other manufacturers within the CODESYS automation alliance in addition to the standard programmable CODESYS automation alliance products from WAGO.

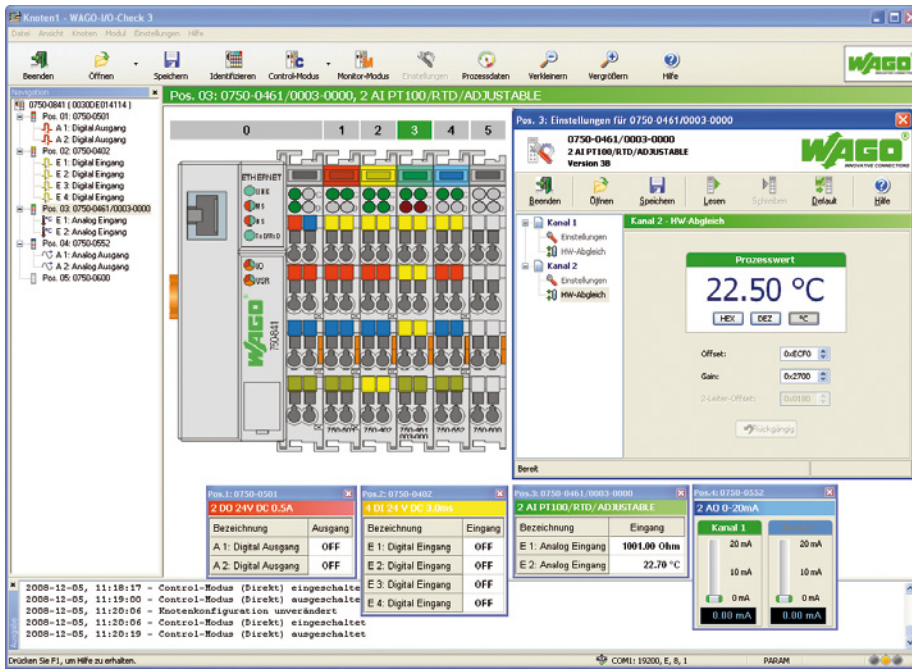
WAGO-I/O-PRO		
Version	Delivery type	Item No.
RS-232 Set	CD-ROM and serial communication cable	759-333
USB Set	CD-ROM and USB communication cable	759-333/000-923

Supported operating systems	Windows 7; Windows 10
<b>System Requirements</b>	
Processor	1 GHz or higher; with 32 bits (x86) or 64 bits (x64)
Memory	1 GB RAM (min.)
Hard disk space	300 MB (min.)
Graphics resolution	1024 x 786 (min.)
Other system requirements	Open serial interface, CD-ROM and mouse required
Delivery type	Installation file (CD-ROM)
Data sheet and further information, see:	<a href="http://wago.com/759-333">wago.com/759-333</a>

Windows® is a registered trademark of Microsoft Corporation.

„ Serial/USB communication cables, see page 48

## WAGO-I/O-CHECK



WAGO-I/O-CHECK is an easy-to-use Windows application for checking inputs and outputs and the display of a WAGO-I/O-SYSTEM 750 node, which does not have to be connected to the fieldbus system at the time.

The software reads the configuration from the node and displays it as a graphic on the screen. The graphic can be printed together with a configuration list as documentation.

With WAGO-I/O-CHECK, it is possible to display and determine the process data of the I/O modules. The field wiring, including all sensors and actuators, can thus be checked before startup.

Application-specific settings, such as the baud rate or type of sensors, can be made with certain interface, Pt100 and thermocouple modules.

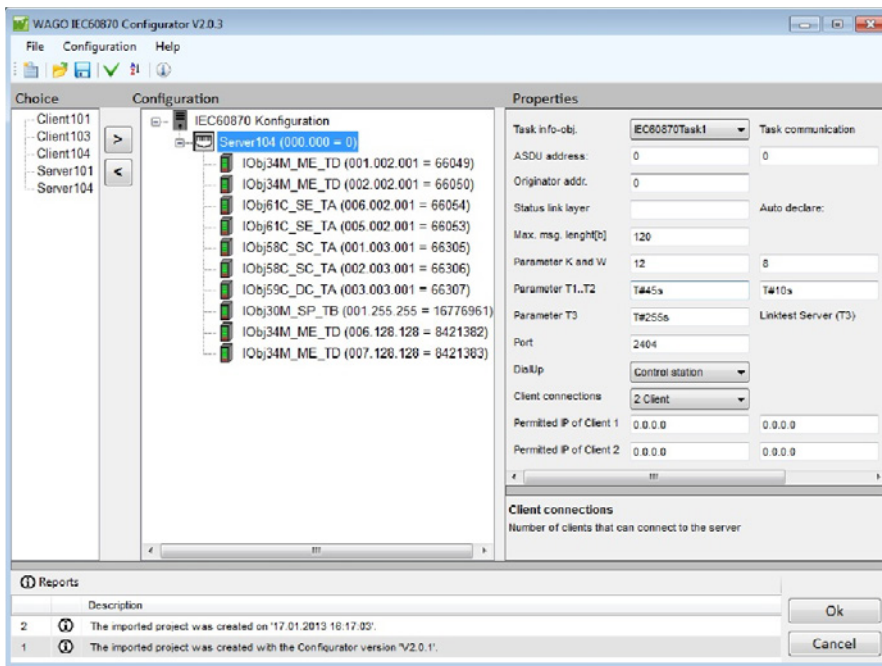
The coupler must be connected at a vacant serial or USB port of the PC using the communication cable supplied in the set with the system to enable communication between WAGO-I/O-CHECK and the coupler.

WAGO-I/O-CHECK		
Version	Delivery type	Item No.
RS-232 Set	CD-ROM and serial communication cable	759-302
USB Set	CD-ROM and USB communication cable	759-302/000-923
CD	CD-ROM	759-920

Supported operating systems	Windows 7; Windows 10
<b>System Requirements</b>	
Processor	1 GHz or higher; with 32 bits (x86) or 64 bits (x64)
Memory	1 GB RAM (min.)
Hard disk space	150 MB (min.)
Graphics resolution	1024 x 786 (min.)
Other system requirements	CD-ROM and mouse required
Delivery type	Installation file (CD-ROM)
Data sheet and further information, see:	<a href="http://wago.com/759-302">wago.com/759-302</a>

Windows® is a registered trademark of Microsoft Corporation.

## IEC 60870 Configurator



The IEC 60870 Configurator is part of the WAGO I/O-PRO V2.3 Software. The configurator fully supports the IEC 60870-5-101/103/104 specific functions of all WAGO telecontrollers.

The configurator sets up IEC 60870 objects, while configuring data exchange to the PLC application or I/O modules. Import and export functions in CSV format allow configured data to be transmitted to other engineering tools.

The IEC 60870-5-101 and 104 protocols are supported on both client and server sides, while the IEC 60870-5-103 protocol is exclusively supported on the client side. This permits the creation of gateways that convert one protocol into another, e.g., allowing protection devices to be read out via IEC 60870-5-103 and data to be transmitted to the network control system via IEC 60870-5-104.

Various options are available for the time synchronization of telecontrol substations (server). Time can be synchronized either via the IEC 60870 protocol with object 103 or via (S)NTP. With the WAGO 750-640 Module, clock time can also be synchronized via DCF77 or GPS.

IEC 60870-5-101/104 information objects can be used to monitor the direction of single, double and step messages. Bit patterns, counter values, as well as normalized, scaled and floating-point measurement values can also be used. All information objects can be transmitted with or without a time stamp. This also applies to information objects in control direction.

An IEC 60870-5-104 server can simultaneously maintain up to four connections to the control system (client).

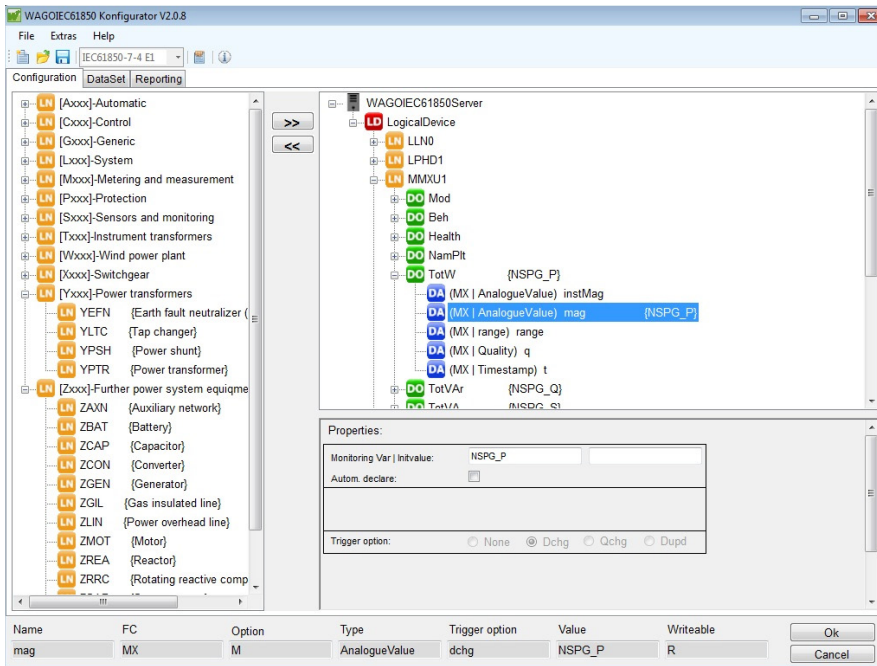
### IEC 60870 Configurator

Integrated in WAGO I/O-PRO V2.3

System requirements	WAGO I/O-PRO Version 2.3.9.40 or higher
Function	IEC 60870-5-101 server and client IEC 60870-5-103 client IEC 60870-5-104 server and client
<b>Supported Controllers</b>	
Controllers PFC200	750-8202/025-001 750-8206/025-001
Controllers PFC200 XTR	750-8202/040-001 750-8206/040-001
Controllers 750	750-872 750-880/025-001 750-880/025-002
Controllers 750 XTR	750-880/040-001

„ Software WAGO I/O-PRO V2.3,  
see page 32

## IEC 61850 Configurator



The IEC 61850 Configurator is part of the WAGO I/O-PRO V2.3 Software. The configurator fully supports the IEC-61850-specific functions of the WAGO telecontrollers.

The configurator sets up IEC 61850 objects, while configuring data exchange to the PLC application or I/O modules.

Import and export functions in IEC 61850 SCL exchange format allow configuration data to be transmitted to other engineering tools.

On the server side, the IEC 61850 protocol is supported for MMS\* communication to the control system. The controllers can also be operated as a GOOSE publisher or subscriber. This permits the creation of gateways that convert one protocol into another, e.g., allowing data from protection devices to be received via the IEC 61850 client and transmitted to the network control system via IEC 60870-5-104 protocol.

Time synchronization is performed via SNTP, NTP, DCF77 and GPS (750-640 Module is also required for GPS).

Various options are available for the time synchronization of telecontrol substations (server): It can either be done via (S)NTP or synchronized with the WAGO 750-640 Module via DCF77 or GPS.

The IEC 61850 MMS server can simultaneously maintain up to five connections to the control system (client).

The IEC 61850 client processes data from up to 10 servers with each 32 requests.

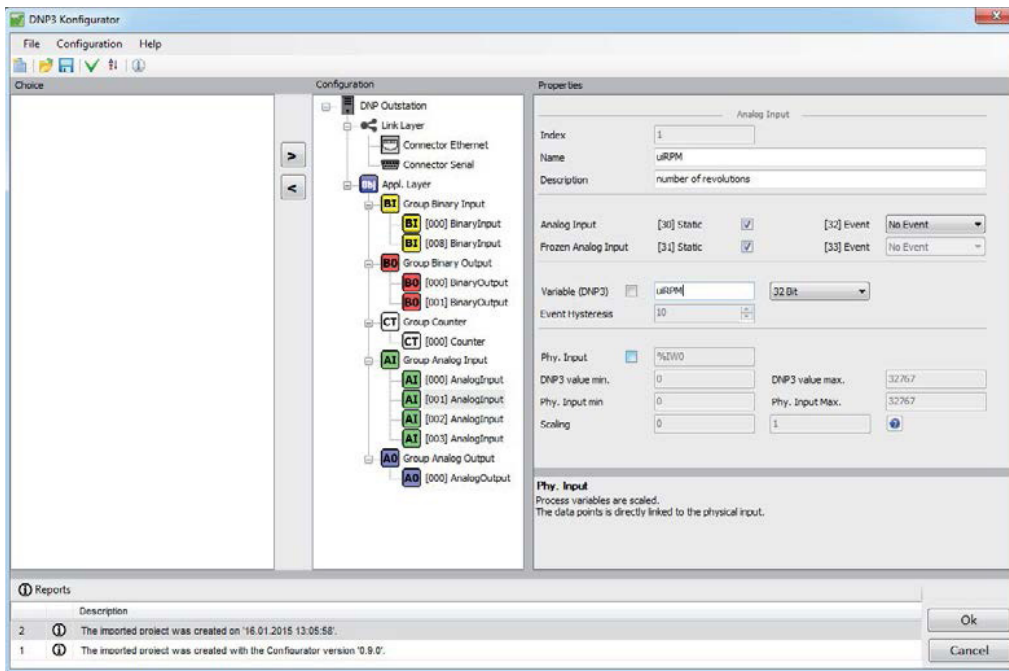
\*MMS = Manufacturing Messaging Specification

### IEC 61850 Configurator

Integrated in WAGO I/O-PRO V2.3

System requirements	WAGO I/O-PRO Version 2.3.9.47 or higher
Function	IEC 61850 server and client
Object types	IEC 61850-7-4 and IEC 61400-25
Data sets	Static and dynamic
Reporting	Buffered and unbuffered
<b>Supported Controllers</b>	
<b>IEC 61850 Server</b>	
Controllers 750	750-872
<b>Supported Controllers</b>	
<b>IEC 61850 Server and Client</b>	
Controllers PFC200	750-8202/025-001 750-8202/025-002 750-8206/025-001 750-8207/025-001
Controllers PFC200 XTR	750-8202/040-001 750-8206/040-001
Controllers 750	750-880/025-001 750-880/025-002
Controllers 750 XTR	750-880/040-001

## DNP3 Configurator



The DNP3 Configurator is part of the WAGO I/O-PRO V2.3. Software. The configurator fully supports the DNP3 specific functions of all WAGO telecontrollers.

The configurator sets up DNP3 objects, while configuring data exchange to the PLC application or I/O modules. The settings can be imported and exported in DNP3 XML device profile format.

WAGO's telecontrollers can work as TCP, UDP and serial DNP3 slave.

Cyclical time synchronization of the telecontrol outstation (slave) can be performed by the master according to DNP3 Device Profile 1.7.2.

In the monitoring direction, the WAGO DNP3 slave can send digital, analog and count values to the master. Both digital and analog values can be received in control direction. Analog values can be processed in 16-bit, 32-bit or FLOAT format. Count values can be processed in 16-bit or 32-bit format.

WAGO's DNP3 slave can simultaneously maintain connections to up four DNP3 masters.

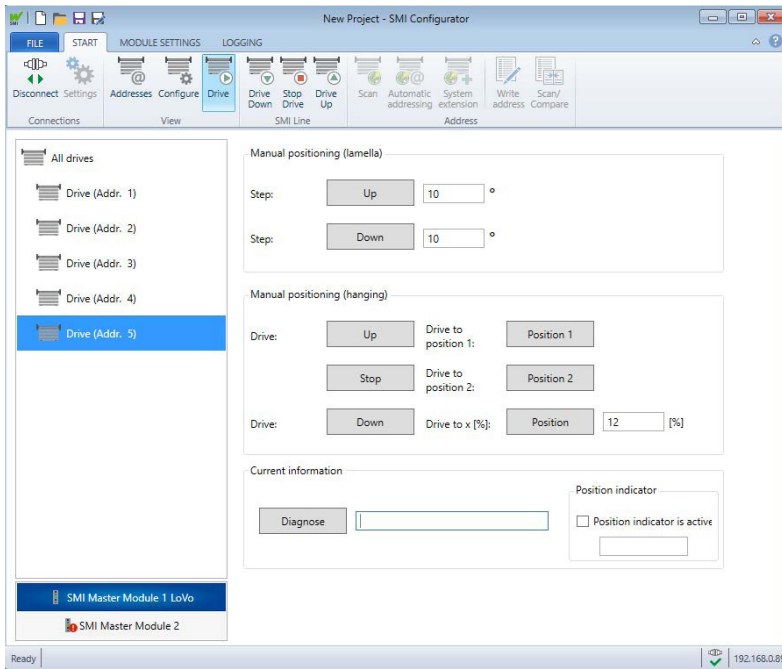
### DNP3 Configurator

Integrated in WAGO-I/O-PRO V2.3

System requirements	WAGO-I/O-PRO Version 2.3.9.48 or higher
Function	Serial DNP3 Slave (RS-232), DNP3 TCP/IP Slave
<b>Supported Controllers</b>	
Controllers PFC200	750-8202/025-001 750-8202/025-002 750-8206/025-001 750-8207/025-001
Controllers PFC200 XTR	750-8202/040-001 750-8206/040-001
Controllers 750	750-872 750-880/025-001 750-880/025-002
Controllers 750 XTR	750-880/040-001
Baud rates	300; 600; 1200; 2400; 4800; 9600; 19200; 38400
Number of control stations	Max. 4

„ Software WAGO-I/O-PRO V2.3,  
see page 32

## WAGO SMI Configurator



The SMI Configurator is parameterization software for SMI master modules. You can use the software to commission SMI drives that are connected to SMI master modules.

The SMI Configurator offers functions for commissioning and configuring SMI drives. Besides the online mode, in which you can control the SMI drives directly, you have the option of using the SMI Configurator in offline mode. This includes offline configuration of all SMI drives connected to available SMI master modules within a node, as well as saving and restoring SMI drive configurations from existing CSV addressing files.

You can directly transfer all module settings of an SMI master module to any number of additional SMI master modules with the "Transfer settings" function. Furthermore, you have the option of using the SMI Configurator to generate project documentation and display the log data of a selected SMI master module.

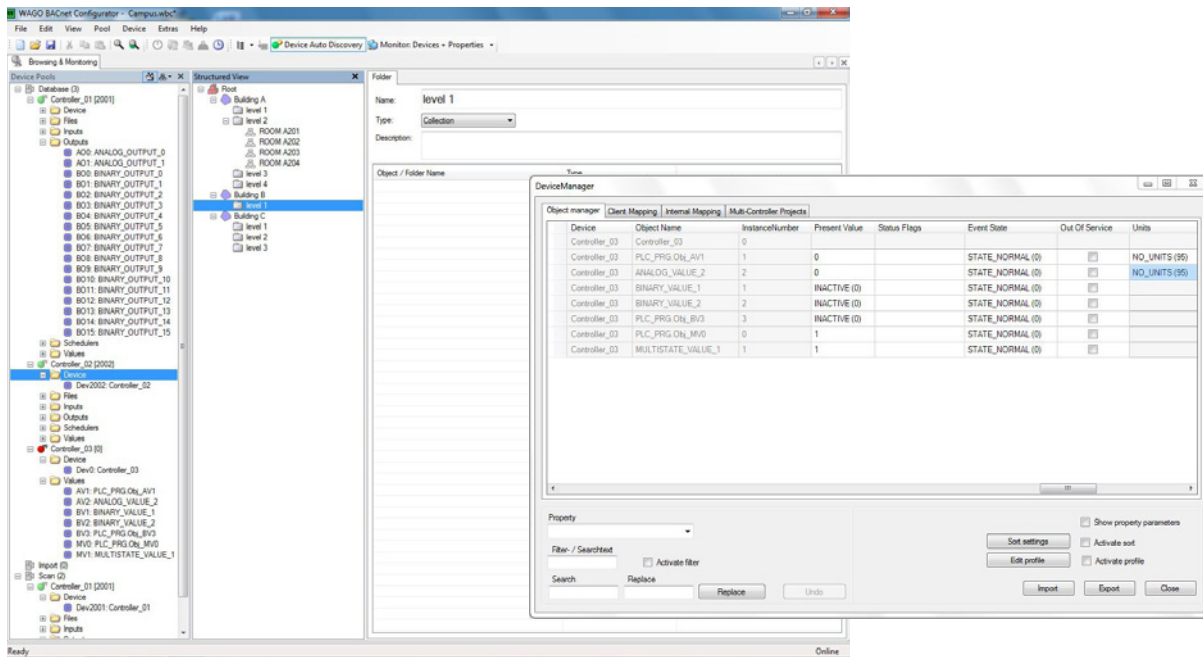
A scan function makes it possible to identify the SMI drives connected to an SMI master module and display the settings in the SMI Configurator. If SMI addresses are missing or there is an address conflict, you can use automatic addressing to assign a new SMI address to all drives automatically, or alternatively use system extension to resolve the address conflict and delete any missing SMI drives.

**WAGO SMI Configurator**  
Download: [www.wago.com](http://www.wago.com)

Supported operating systems	Windows 7; Windows 10
<b>System Requirements</b>	
Processor	1 GHz (min.)
Memory	1 GB (min.)
Hard disk space	20 MB (min.) for the SMI Configurator and 60 MB for the .NET Framework 4.0
Other system requirements	.NET Framework 4.0
Delivery type	Download

Windows® is a registered trademark of Microsoft Corporation.

## WAGO BACnet Configurator



The BACnet Configurator is an independent commissioning, configuration and management software program. The configurator fully supports the BACnet-specific functions of WAGO's 750-829, 750-830 and 750-831 BACnet Controllers.

The configurator creates and configures WAGO BACnet Controllers and sets up data exchange between the IEC application and BACnet objects. Import and export functions allow further processing of the configuration data.

For integration into existing BACnet networks, the BACnet devices available can be scanned and displayed in a browser; also, data exchange can be implemented for WAGO devices.

Among the configurator's capabilities are the logical structuring of the project and network, addressing of the controller and client/server configuration in every WAGO BACnet Controller.

The devices, objects and configuration data are displayed in a logical, structured network and browser view.

Depending on the function used, both online and offline operation is possible.

The configurator displays all configuration data. To edit BACnet objects, the configurator offers specific table views in which the corresponding properties of the object can be modified. Typical table editing functions, e.g., search/replace, sort, filter and show/hide, are available. The user can upload the updated configuration data to one or more controllers and save as a project.

The configurator provides a browser to view the BACnet object properties and modify current parameters (communicate value changes, write property values, utilize BACnet services, etc.). Additionally, a transaction log window is available for client services.

### BACnet Configurator

The BACnet Configurator can be downloaded for free at:  
see: [www.wago.com](http://www.wago.com)

Supported operating systems

Windows 7; Windows 10

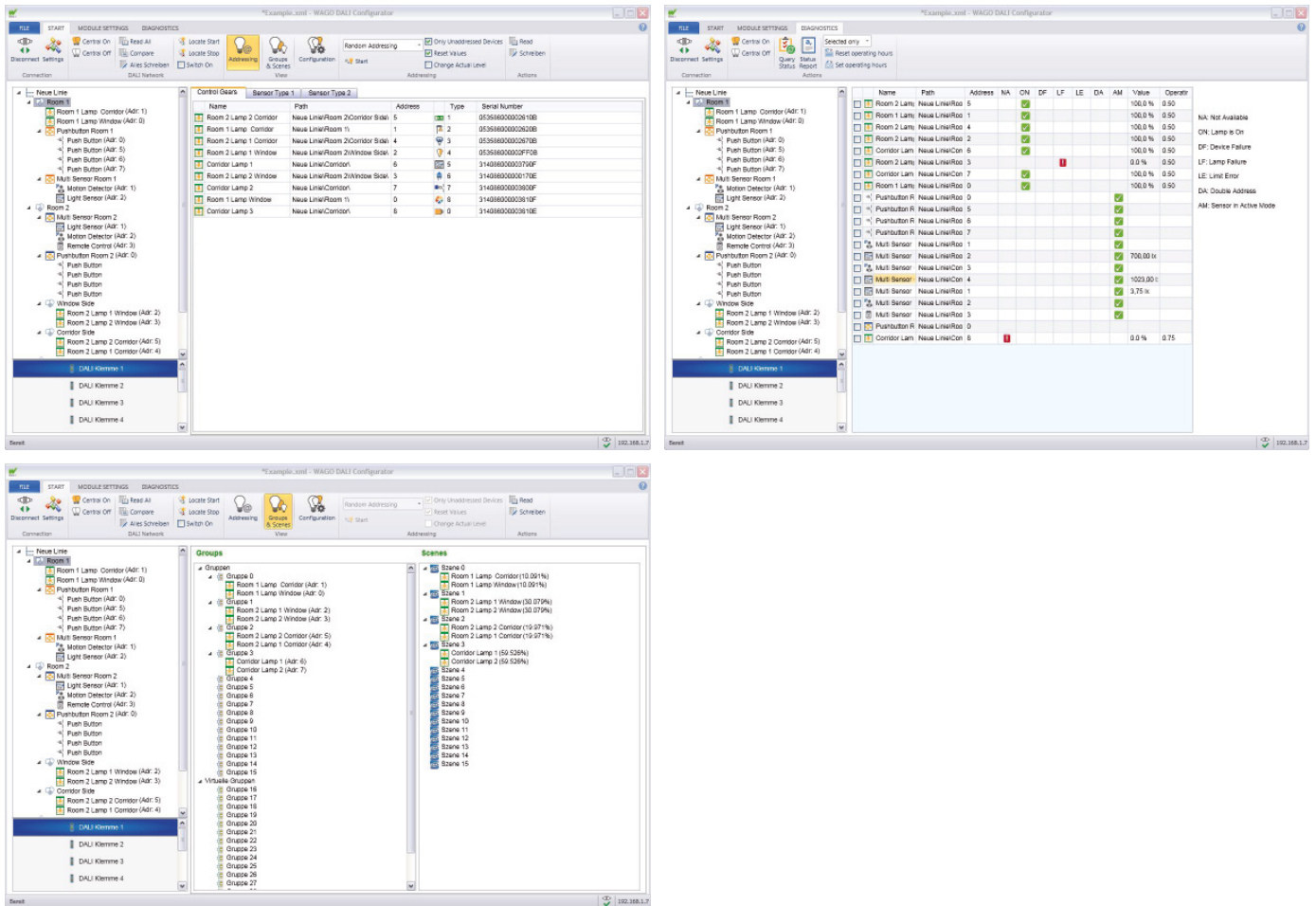
Windows® is a registered trademark of Microsoft Corporation.

„ Software WAGO-I/O-CHECK,  
see page 33

„ Software WAGO-I/O-PRO V2.3,  
see page 32



# WAGO DALI Configurator



2

The DALI Configurator simplifies commissioning of a DALI network via 753-647 DALI Multi-Master. The configurator is available as a stand-alone Windows application or for use with WAGO-I/O-CHECK Software.

It provides the following functions: easy commissioning, configuration, service, support and maintenance of a DALI network. Comprehensive backup & restore features, as well as an offline configuration option for the entire DALI network (including ECGs and sensors) are available.

## DALI Configurator

The DALI Configurator is available as part of WAGO-I/O-CHECK (Version 3.5.1 or higher) or as a stand-alone version ([www.wago.com](http://www.wago.com)).

### Features

#### Commissioning function

#### Service, support and maintenance functions

#### Windows-compliant user interface

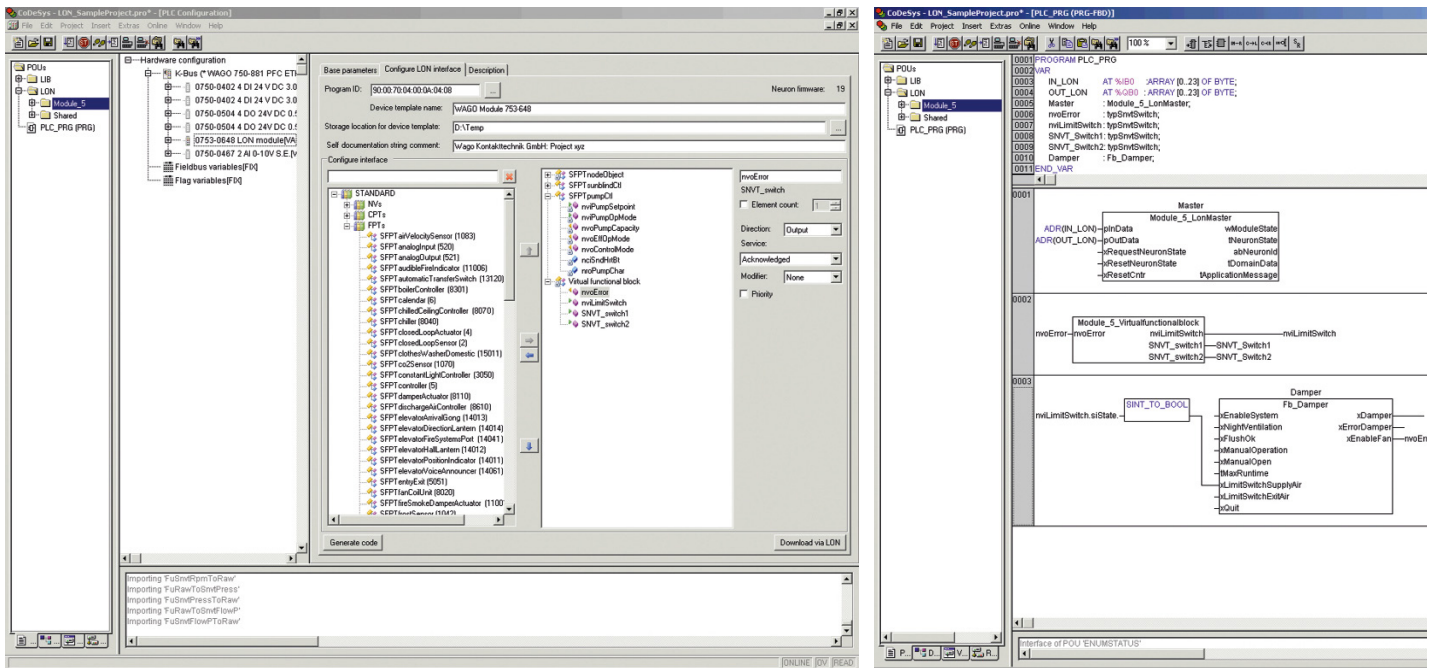
Stand-alone software or for use with WAGO-I/O-CHECK

Addressing, scenes and group formation; control gear configuration, optional offline configuration, import and export functions, project documentation

Backup & restore, reporting ECG illuminant failures, identification of doubled addresses, diagnostics report

Multiple selection for time-optimized configuration and a clearly organized network display with tree structure support different commissioning workflows

## WAGO LON® Configurator



The LON® Configurator is an integral part of the WAGO-I/O-PRO IEC-61131-3 programming environment. The configurator supports both the 753-648 LON® Module's LonWorks® network interface configuration and WAGO-I/O-PRO project integration.

Network variables of any type can be defined. In addition to standard network variable types (SNVTs) and standard configuration property types (SCPTs), user-defined types (UNVTs/UCPTs) and LonMark® functional profiles (FPTs) are also supported. Network variables are defined using the types and objects of the LonMark® resources installed on your computer.

IEC-61131-3 function blocks are automatically created in the IEC application, simplifying operation. The function blocks represent the LON® network interface in the IEC application. When starting the control unit, both network variable interface and configuration data are automatically downloaded into the I/O module.

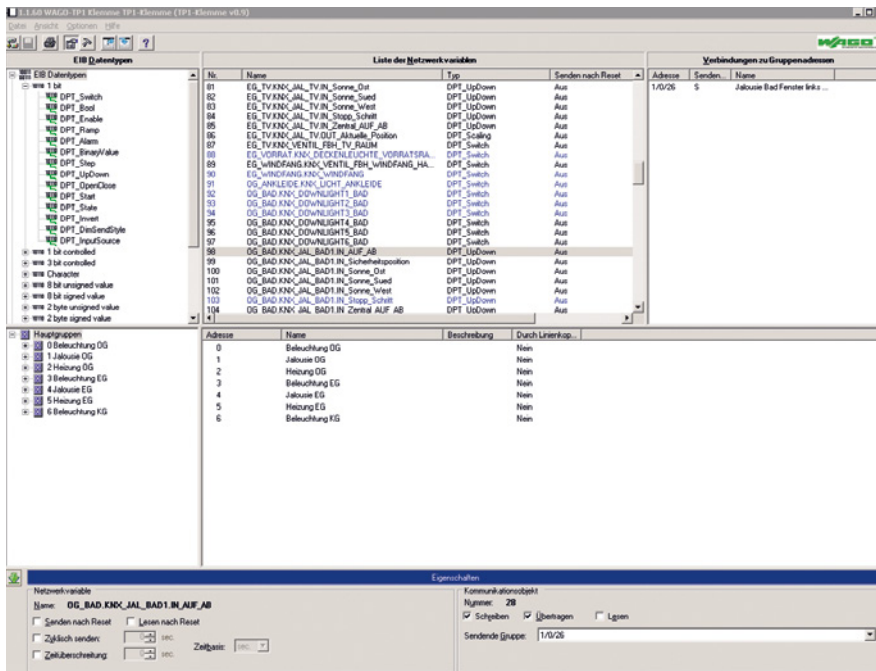
An external interface file (XIF) is created for offline configuration in a network management tool.

### LON® Configurator

The LON® Configurator is available as part of WAGO-I/O-PRO (Version 2.3.9.34 or higher)

- Integral part of WAGO-I/O-PRO programming software
- Defines and implements a LON® network interface
- Automatically generates IEC 61131-3 function blocks to represent the LON® network interface within an IEC application
- Downloads both network interfaces and configuration data when controller is started
- Configuration check and test
- Generates XIF files

## WAGO ETS Plug-In



2

The WAGO ETS Plug-In is a WAGO ETS product database extension that allows the use of WAGO devices, such as the 753-646 KNX/EIB/TP1 Interface, 750-889 KNX IP Controller and KNXnet/IP Router (consisting of KNX/EIB/TP1 Interface and KNX IP Controller).

The software's enhanced structure offers intuitive navigation – providing both new and experienced ETS users with exceptional usability.

The WAGO ETS Plug-In provides three clearly structured user interfaces for the various devices. Depending on the mode selected, either the KNX/EIB/TP1 Module, KNX IP Controller or the KNXnet/IP Router (IP Controller with KNX/EIB/TP1 Module in first position) are supported.

In the graphical interfaces, device parameters are easy to configure. Only the options pertaining to the selected device are displayed.

During software development, creating a convenient and time-saving graphical user interface was heavily emphasized – and this is beneficial when assigning communication objects to group addresses. Two different drag-and-drop options and a context menu with automatic filter function are available allowing the user to select his favorite procedure.

### WAGO ETS Plug-In

The WAGO ETS Plug-In can be downloaded for free at:  
see: [www.wago.com](http://www.wago.com)

### Supported operating systems

Windows 7; Windows 10

### Other

The plug-in requires the ETS product database.

### Configuration

KNX/EIB/TP1 Module

Load/assign IEC variables (communication objects); Create/configure group addresses

KNX IP Controller

Allocate IP addresses; Download IEC application to controller; Load/assign IEC variables (communication objects); Create/configure group addresses

KNXnet/IP Router

Allocate IP addresses; Set routing multicast addresses; Filter/transmit telegrams

Windows® is a registered trademark of Microsoft Corporation.

# Runtime Software – Libraries

## e!COCKPIT (Based on CODESYS V3)

2



### Runtime Software Controls the Machine

Machines and systems are controlled by runtime software that determines behavior, while enabling both operation and current status monitoring for the user. It also transmits operating data to higher-level systems. Unlike engineering software, runtime software operates continuously – it is a part of the machine and ensures correct operation.

### Ready-to-Use Function Blocks Save Development Time

Comprehensive, tried-and-tested software function blocks (IEC libraries) expedite development. Thus, e!COCKPIT is supplemented with comprehensive IEC libraries.

Essentially, the libraries are divided into three abstraction layers:

The solution layer primarily contains complete, easy-to-use software solutions for production, building and process automation.

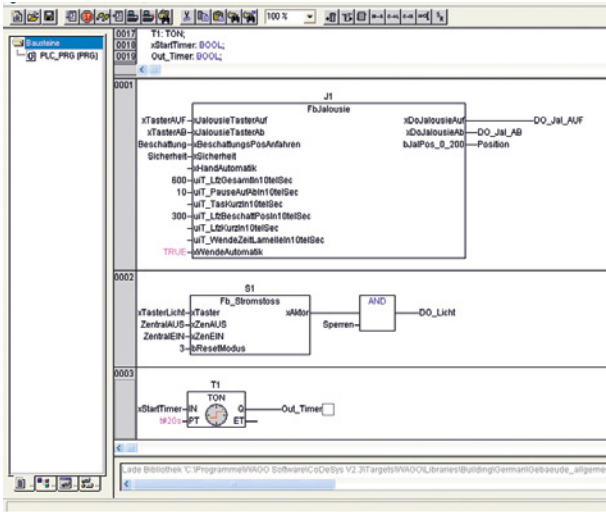
The application layer contains technology functions, e.g., for communication, that are ideal for convenient, easy application. The system layer provides experts with complete system access.

The upper layers are separated by compatibility levels. Essentially, this enables software to be developed independently of the hardware it will be used on. This provides the greatest degree of flexibility in selecting the right device for the right application, while retaining a uniform software base. It also provides investment security.

**Function Modules and Libraries**  
 Integrated into the e!COCKPIT Software

„ Software e!COCKPIT, see page 26

# Runtime Software – Libraries WAGO-I/O-PRO (Based on CODESYS V2.3)

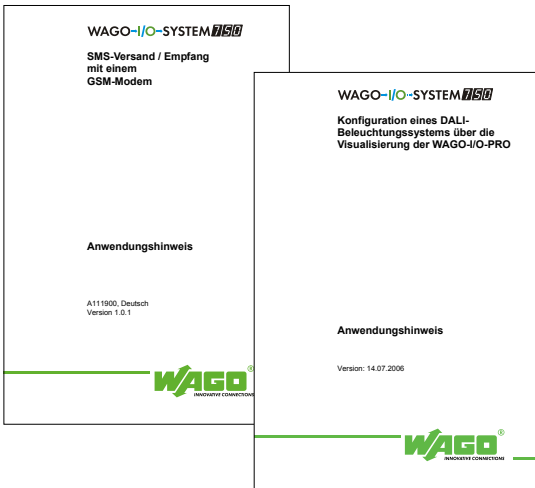


2

## Room Applications Integrated into WAGO-I/O-PRO Software

The library contains custom function blocks for building automation, which accelerate the programming of building applications.

- Lighting
- Only addressing Control Gears (ECG) without short address
- Lighting scenes
- Constant light control
- Sun protection
- Shading
- Other applications



## Application Notes Download: Current application notes can be downloaded at: see: [www.wago.com](http://www.wago.com)

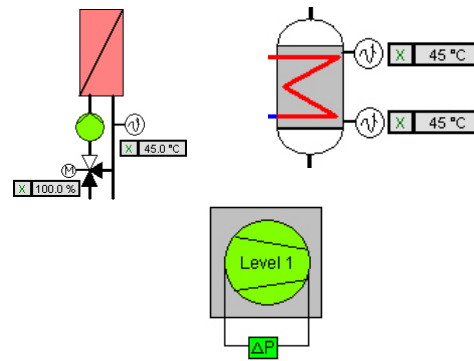
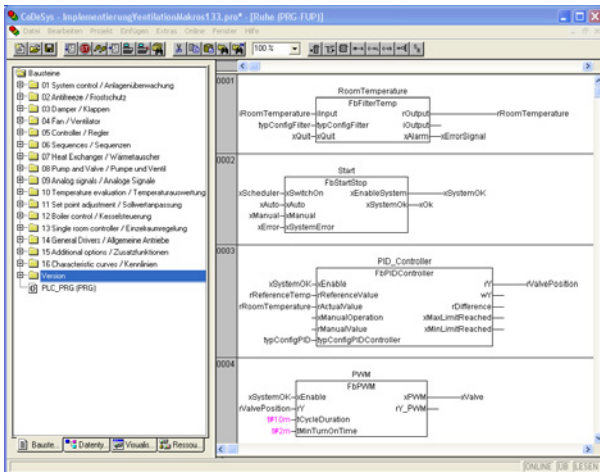
The application notes contain function blocks (FB) for communication applications.

- KNX/EIB
- DALI
- EnOcean Radio Technology
- MODBUS
- M-Bus
- MP-Bus
- SMI
- LonWorks®
- Email
- SMS
- Other applications

# Runtime Software – Libraries

## WAGO-I/O-PRO (Based on CODESYS V2.3)

2



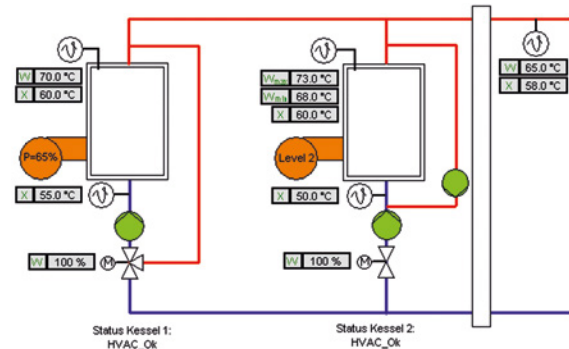
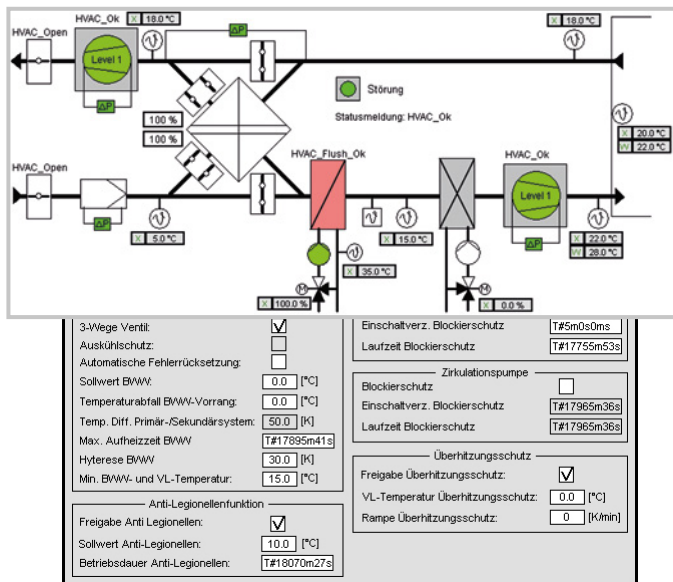
Graphical elements for HVAC applications

### HVAC

Integrated into WAGO-I/O-PRO Software

The library contains function blocks (FB) to create automation applications for complex heating, ventilation and air-conditioning systems (HVAC).

These include: fault monitoring, starter circuits, monitoring frost protection systems, fan control (stepped/continuous), air mixture valve control, air heater/cooler control, cascade control of room/feed air temperature, free night cooling, summer/winter compensators, enthalpy calculations, PID controllers, filter monitoring, blockage protection, heating circuit control, heat recovery control, boiler control (stepped/continuous), boiler sequence, domestic hot water control, start/stop optimization, humidification and dehumidification (climate) and more.



Boiler sequence control

### System Macros

Download: Current application notes can be downloaded at: [see: www.wago.com](http://www.wago.com)

- District heating transfer station macros
- Boiler macros
- Heating circuit macros
- Drinking water heating macros
- Ventilation macros

„ Software WAGO-I/O-PRO V2.3, see page 32

## Runtime Software e!RUNTIME EtherCAT Master 300

### Function:

EtherCAT is a powerful real-time ETHERNET fieldbus system that has become standard in many industrial automation applications. The PFC200 controller (2nd generation) can run as an EtherCAT master. This requires a licence.

The EtherCAT system is configured via special configuration dialogs in the e!COCKPIT Engineering Software. These specify:

- That the controller should function as an EtherCAT master
- What field devices should be addressed
- What form the topology of the network takes
- What parameter values should be sent to the slaves upon startup

Besides the protocol stack in the form of a library, the run-time system also provides components for direct access to the ETHERNET interface and diagnostics.

### Advantages:

- Using the PFC200 as an EtherCAT Master
- Controlling WAGO slaves with the EtherCAT fieldbus system, e.g., the EtherCAT fieldbus coupler of the WAGO-I/O-SYSTEM 750
- Controlling additional field devices, which can be declared in e!COCKPIT via a standardized device description

### Use:

The licence is acquired in e!COCKPIT, assigned to a controller and loaded into the controller together with the project. No other installation steps are required.

### Technical Data:

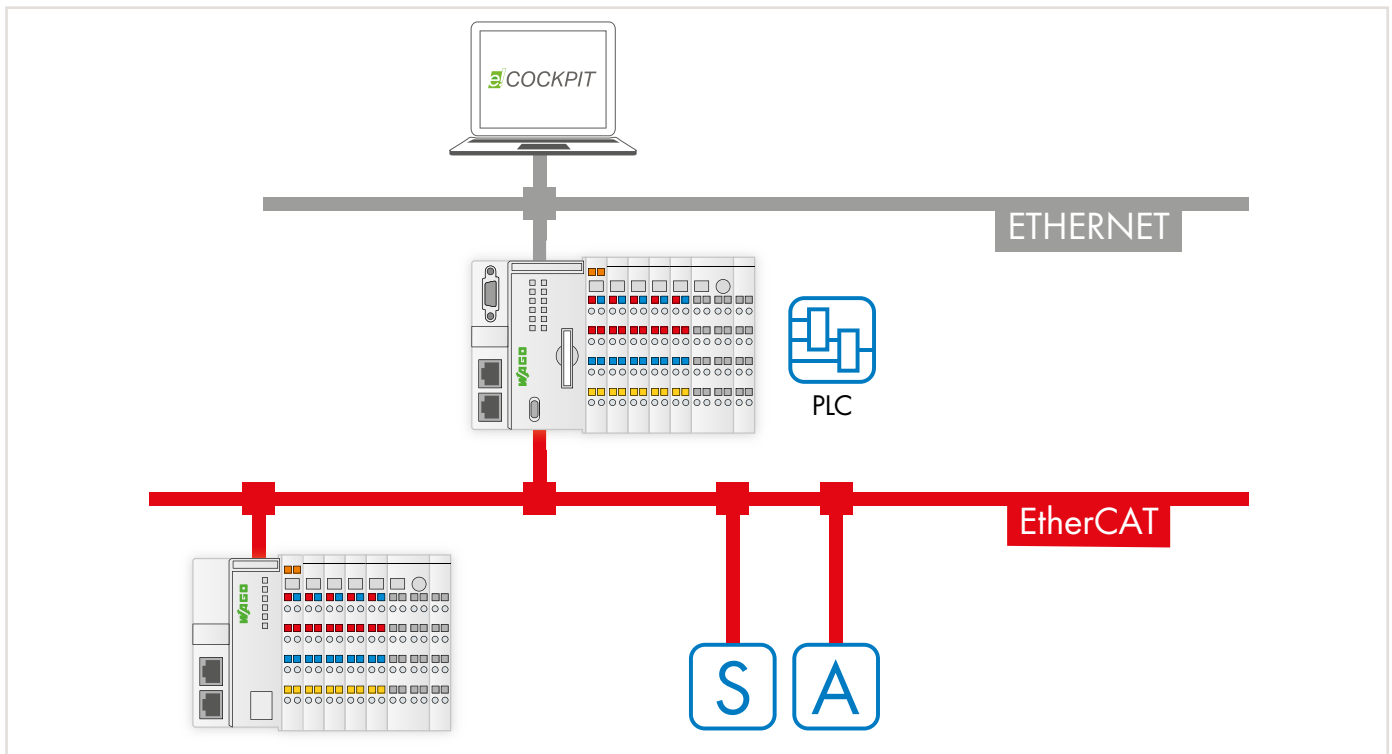
Distributed clocks

Hot connect

Bus diagnostics: In the configurator and with the PLC application

Supported layer 7 protocols:

- CoE (CANopen / CAN over EtherCAT)
- FoE (File over EtherCAT),
- VoE (Vendor over EtherCAT)



Item Description	
<b>e!RUNTIME EtherCAT Master 300</b>	<b>Item No.</b>
Single license	2759-263/210-1000
Compatible Controllers	
PFC200; G2; 2ETH RS	750-8212
PFC200; G2; 2ETH CAN	750-8213
PFC200; G2; 2ETH RS CAN	750-8214
PFC200; G2; 4ETH CAN USB	750-8215
PFC200; G2; 2ETH RS CAN DPS	750-8216

Besides the basic controller variants listed here, the licence can also be used on these controllers' variants. For details, see the product information of the corresponding controller.

You can find detailed information on the controllers in Section 4.1.

Minimum e!COCKPIT version	V1.5.0
Delivery type	Licence certificate via email (e!COCKPIT already contains the software itself)
Data sheet and further information, see:	<a href="http://wago.com/2759-263/210-1000">wago.com/2759-263/210-1000</a>

An Internet connection to the PC with the e!COCKPIT installation may be required for licence activation.

The single license allows installation on one controller.

One licence per controller is required.

# WAGO WebVisu App For Mobile System Operation/Monitoring



2

With the WebVisu App, you can visualize web pages created for WAGO Controllers via e!COCKPIT or CODESYS V2. The app features both automated management and routing capabilities, allowing the website to be simply accessed via URL entry. The system or machine to be monitored can then be operated and monitored at any time on the go. You can define up to 100 controllers for direct and quick access via the URL.

The free WAGO WebVisu App is available in iOS for iPhones and iPads in the "Apple Store," and in Android for smartphones and tablets in the "Google Store."

Note: An overview of the supported WAGO controllers, operating manuals and application notes can be found on our website.



QR Code for WebVisu App

Simply scan the QR code with your mobile device and you will automatically be directed to the Web-Visu App in "App Store" or "Google PlayTM."



### Trademarks

Apple, the Apple logo, iPhone, iPad and iPod touch are registered trademarks of Apple Inc. registered in the USA and other countries. "App Store" is a service mark of Apple Inc.



Google PlayTM is a registered trademark of Google Inc.

**WAGO WebVisu App**  
Download: Apple Store or Google Store

<b>System Requirements</b>	
Operating system	iOS version 10.2 or later, Android version 4.2 or later
Compatibility	iPhone; iPad and iPad Air; Android smartphones and tablets
For additional information, see:	<a href="http://wago.com/webvisu">wago.com/webvisu</a>



2

## Accessories



USB Communication Cable; USB-A; Service Interface WAGO-I/O-SYSTEM 750		
Length	Item No.	Pack. Unit
2.5 m	750-923	1
5 m	750-923/000-001	1



RS-232 Communication Cable; RS-232 (D-Sub 9-pole); Service Interface WAGO-I/O-SYSTEM 750		
Length	Item No.	Pack. Unit
1 m	750-920	1



Bluetooth® Adapter; Service Interface WAGO-I/O-SYSTEM 750		
	Item No.	Pack. Unit
	750-921	1

2

2



# Operation and Monitoring

## Touch Panels 600 Standard Line

- High-performance touch panels with resistive touch-screens
- 10.9 ... 25.7 cm (4.3 ... 10.1")
- Models include Control, Visu or Web Panel for display of e!COCKPIT visualizations

## Touch Panels 600 Advanced Line

- High-performance touch panels with capacitive touch-screens and glass surfaces
- 18 ... 25.7 cm (7 ... 10.1")
- Models include Control or Visu Panel

## Controllers PFC100/PFC200

- Maximum performance in a minimum space
- Also programmable in high-level languages based on Linux®
- Security packages with SSH and SSL/TLS
- Runtime system for CODESYS V2 (only PFC200) and V3

Section 4.1 ►

## Touch Panels 600 Marine Line

- High-performance touch panels with resistive touch-screens
- Ideal for marine applications
- 10.9 ... 25.7 cm (4.3 ... 10.1")
- Models include Visu Panel

## Touch Panels e!DISPLAY 7300T

- Touch panels with resistive touchscreens
- 10.9 ... 25.7 cm (4.3 ... 10.1")
- Models include Web Panel for display of CODESYS V2 or e!COCKPIT visualizations

## Controllers PFC200 XTR

- The advantages of WAGO's PFC Controllers combined with the capabilities for extreme environments:
- High processing speed
  - Multiple interfaces
  - eXTRemely robust and maintenance-free

Section 4.2 ►►

# Operation and Monitoring Contents

	Page
General Product Information	52
Functional Variants	53
Interfaces and Types	54
Application and Installation Instructions	56
Item Number Key	57
Standards and Rated Conditions	57
Approvals	57



	CPU	Web Browser	Modbus (TCP, UDP)	EtherNet/IP	CANopen	IoT Protocols	Description	Hardware	Item No.	
<b>Touch Panels 600 Standard Line</b>	Cortex A9	x	M/S	S	M/S	x	Control Panel; 10.9 cm (4.3"); Resistive touchscreen	PIO3	762-4301/8000-002	58
		x	M/S	S	M/S	x	Control Panel; 14.5 cm (5.7"); Resistive touchscreen	PIO3	762-4302/8000-002	59
		x	M/S	S	M/S	x	Control Panel; 18 cm (7.0"); Resistive touchscreen	PIO3	762-4303/8000-002	60
		x	M/S	S	M/S	x	Control Panel; 25.7 cm (10.1"); Resistive touchscreen	PIO3	762-4304/8000-002	61
		x	M				Visu Panel; 10.9 cm (4.3"); Resistive touchscreen	PIO2	762-4201/8000-001	58
		x	M				Visu Panel; 14.5 cm (5.7"); Resistive touchscreen	PIO2	762-4202/8000-001	59
		x	M				Visu Panel; 18 cm (7.0"); Resistive touchscreen	PIO2	762-4203/8000-001	60
		x	M				Visu Panel; 25.7 cm (10.1"); Resistive touchscreen	PIO2	762-4204/8000-001	61
		x					Web Panel; 10.9 cm (4.3"); Resistive touchscreen	PIO1	762-4101	58
		x					Web Panel; 14.5 cm (5.7"); Resistive touchscreen	PIO1	762-4102	59
		x					Web Panel; 18 cm (7.0"); Resistive touchscreen	PIO1	762-4103	60
		x					Web Panel; 25.7 cm (10.1"); Resistive touchscreen	PIO1	762-4104	61
<b>Touch Panels 600 Advanced Line</b>	Cortex A9	x	M/S	S	M/S	x	Control Panel; 18 cm (7.0"); Capacitive touchscreen with glass surface	PIO3	762-5303/8000-002	62
		x	M/S	S	M/S	x	Control Panel; 25.7 cm (10.1"); Capacitive touchscreen with glass surface	PIO3	762-5304/8000-002	63
		x	M				Visu Panel; 18 cm (7.0"); Capacitive touchscreen with glass surface	PIO2	762-5203/8000-001	62
		x	M				Visu Panel; 25.7 cm (10.1"); Capacitive touchscreen with glass surface	PIO2	762-5204/8000-001	63
<b>Touch Panels 600 Marine Line</b>	Cortex A9	x	M				Visu Panel; 10.9 cm (4.3"); Resistive touchscreen, marine version	PIO2	762-6201/8000-001	64
		x	M				Visu Panel; 14.5 cm (5.7"); Resistive touchscreen, marine version	PIO2	762-6202/8000-001	64
		x	M				Visu Panel; 18 cm (7.0"); Resistive touchscreen, marine version	PIO2	762-6203/8000-001	65
		x	M				Visu Panel; 25.7 cm (10.1"); Resistive touchscreen, marine version	PIO2	762-6204/8000-001	65
<b>Touch Panels e!DISPLAY 7300T</b>	Cortex A8	x					Web Panel; 10.9 cm (4.3"); Resistive touchscreen	PIO1	762-3000	66
		x					Web Panel; 14.5 cm (5.7"); Resistive touchscreen	PIO1	762-3001	66
		x					Web Panel; 18 cm (7.0"); Resistive touchscreen	PIO1	762-3002	67
		x					Web Panel; 25.7 cm (10.1"); Resistive touchscreen	PIO1	762-3003	67



**Accessories**

Memory cards; Mounting sets

M: Master; S: Slave

## Operation and Monitoring

### General Product Information

Operate, observe, visualize and diagnose in production and the process industry: WAGO's Touch Panels with various hardware configurations are available for small- to mid-sized control and visualization tasks. Focus on saving time with perfect usability and quickly created visualizations.

#### Adapted Versions

The right version is available for every application:

- Devices with resistive touchscreens for standard control cabinet applications
- Multi-touch devices with a glass surface for more extensive requirements
- Devices for marine applications

#### Touch Panels that Merge Aesthetics with High Performance

Underneath a contemporary design, WAGO's Touch Panels pack some of the industry's most powerful equipment, allowing you to solidify the high-tech image of your machine or through high-quality visualizations from both *e!COCKPIT* (CODESYS V3) and CODESYS V2 Engineering Software. The Web-based management feature of WAGO's controllers may also be operated using the stylish Web Panels. When configuring with *e!COCKPIT*, visualizations are created based on modern technologies such as HTML5.

#### Industry 4.0/IoT

Recording, digitizing and linking data profitably – this is the core concept behind Industry 4.0. Using a dedicated library, control panels become IoT controllers that send data from the field level to the cloud, where it can be aggregated and used for analysis. This creates true added value for your company – whether for increasing the efficiency of in-house production, implementing energy management in buildings or developing additional end-customer services. Existing systems also become IoT-ready, making them sustainable into the future.

#### Quick Installation via Unique Mounting Design

WAGO's Touch Panel directly latches onto the control cabinet via mounting clips for quick and easy tool-free installation. With specially developed clamps, the high IP65 degree of protection can be achieved for the front of the display. This design flexibility makes the display extremely versatile and suitable for a wide variety of applications. Furthermore, the VESA mount allows installation on a swivel arm or stand outside of the control cabinet.

#### Easy to Use – Directly on the Display

All touch panels have status LEDs that indicate operating status and provide operational feedback. A customized configuration interface is available for configuring and commissioning the touch panels. All important settings are made here via Web-based management. For quick and easy custom settings, the display brightness can also be manually adjusted via front-mount button.

#### Energy-Saving Sensors Ensure Safety

WAGO Touch Panel's integrated proximity sensor allows the visualization to be automatically re-displayed from the energy-saving screensaver. An integrated sensor simultaneously detects ambient lighting levels for brightness control.

#### Integrated Controller

In the Control Panel function, the devices offer an integrated PLC function, which is configured via *e!COCKPIT*, based on IEC 61131-compatible CODESYS. This makes them programmable in five standardized languages. In addition to pure programming, *e!COCKPIT* is also used for offline simulation, fieldbus configuration, recipe management and much more.

#### Scaled Visualization Functions

Displaying a visualization in a Web browser makes flexible options available. In addition to the Web Panels, visualizations can be displayed on nearly any device with a browser including smartphones and tablets by using the WebVisu app.

When greater performance is required, devices are used as Visu Panels. In the process, all operating functions are evaluated within the device without a delay and can affect the visualization directly. The data to be displayed are read in via standardized bus systems, e.g. via Modbus TCP.

#### Open-Source Software and Linux®

We unite what belongs together: WAGO's high-performance hardware and the future-ready Linux® operating system. For complex tasks, you have the choice between programming in either IEC 61131 or directly in Linux®. WAGO's "Embedded Linux" Controllers impress with base images that are expandable via open-source packages. As a "Gold Member" of the Open Source Automation Development Lab (OSADL), WAGO supports both financing and further development of Linux® in the industrial sector. The controller firmware itself is available as a "Board Support Package" (BSP).

If you are interested, simply contact our *AUTOMATION* technical support.

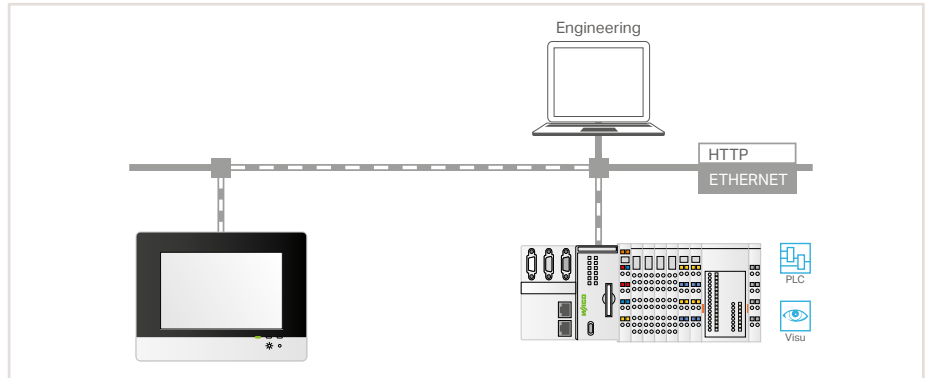
#### Advantages:

- An aesthetic design meets high performance
- Scaled portfolio in design and functionality
- Easy to use – directly on the display
- Quick installation via unique mounting design
- IoT ready

## Operation and Monitoring Functional Variants

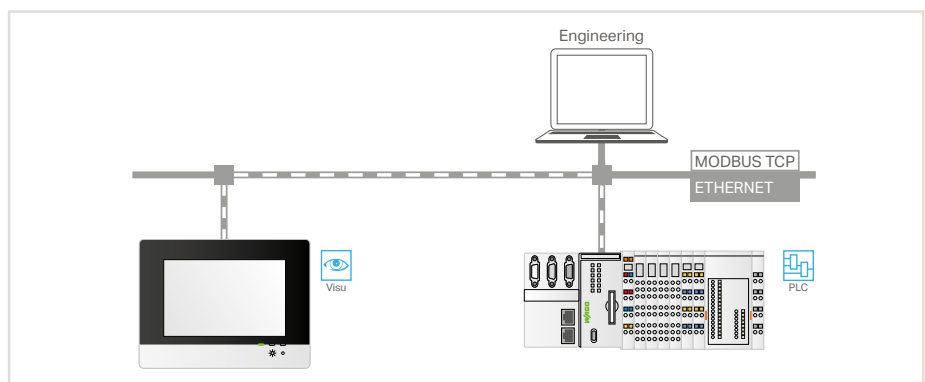
### Web Panels

The operating and display devices in the Web Panel software configuration are provided with a Web browser for accessing WAGO Controllers via standard Web protocols with integrated Web visualization for display. Depending on the type of execution, Web visualizations that are created with *e!COCKPIT* (based on CODESYS V3) and/or with CODESYS V2 can be displayed. Web visualizations have the advantage of being displayed not only on special Visu Panels, but also on standard commercial mobile devices.



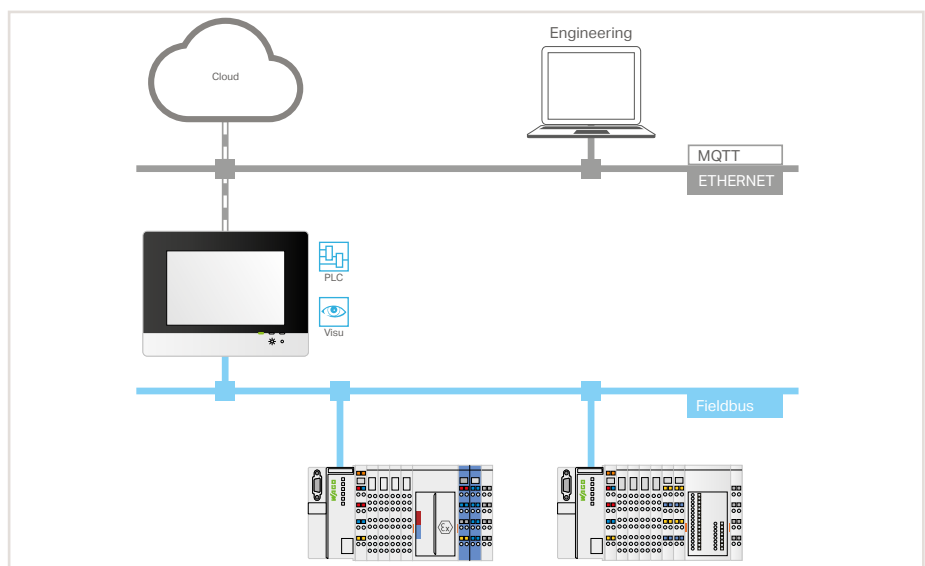
### Visu Panels

Operating and display devices in the Visu Panel software configuration are suitable for displaying a visualization generated with *e!COCKPIT* and obtaining the data referenced in it from any field devices via TCP, e.g., from PFC200-type controllers. In contrast to Web Panels, the computing power required here is divided between two devices, so the computing necessary for displaying the visualization is basically performed by the Visu Panel, offloading the controller. The Visu Panel can also provide a Web visualization via the integrated Webserver.



### Control Panels

Operating and display devices in the Control Panel software configuration allow control and visualization to be performed simultaneously, representing a very compact form for an automation solution. WAGO's Control Panels handle all the usual tasks that would otherwise be performed by a separate controller, including establishing a connection to the cloud, for example.



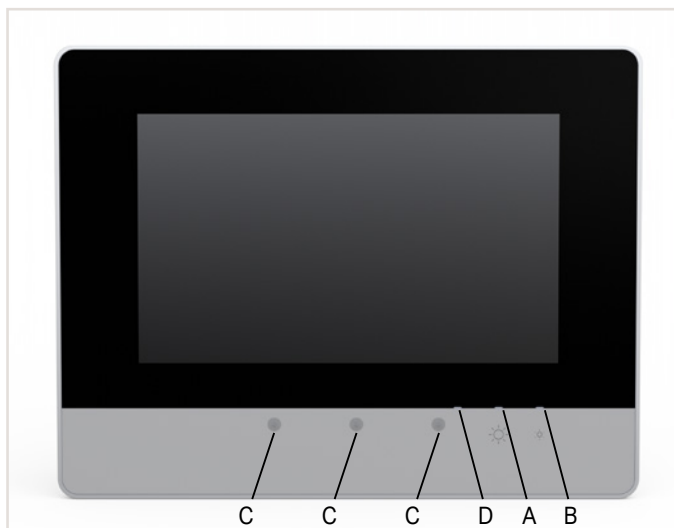
## Operation and Monitoring Interfaces and Types

### Touch Panels Standard Line

By default, the WAGO Touch Panels are equipped with resistive touch. In addition, they have two capacitive buttons (A), (B) for on-device brightness settings. A 3-color status LED (D) indicates the device status. An integrated motion and brightness sensor (C) detects when a person is approaching and automatically turns off the screensaver. In addition, it can be used for automatic brightness change (day/night).

Available sizes:

- 10.9 cm (4.3")
- 14.5 cm (5.7")
- 18 cm (7.0")
- 25.7 cm (10.1")

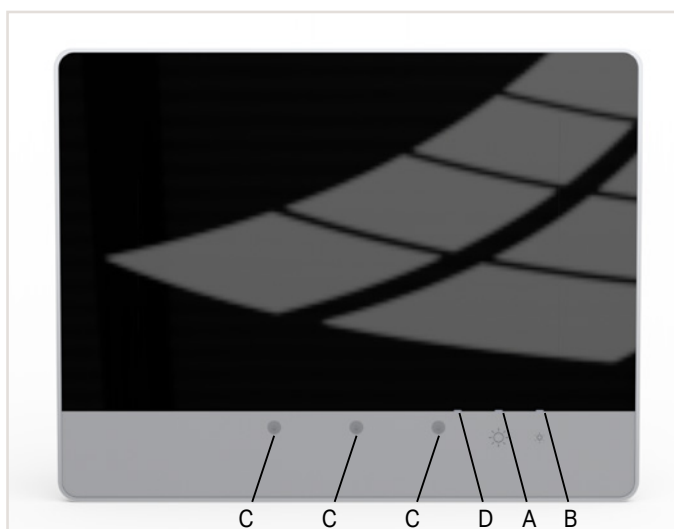


### Touch Panels Advanced Line

In contrast to the standard version, these devices are equipped with a capacitive touch and a glass surface. This allows gesture recognition, e.g., to swipe for turning pages or to enlarge. In addition, the glass front is characterized by a stronger mechanical and chemical resistance. Glove operation is also possible.

Available sizes:

- 18 cm (7.0")
- 25.7 cm (10.1")

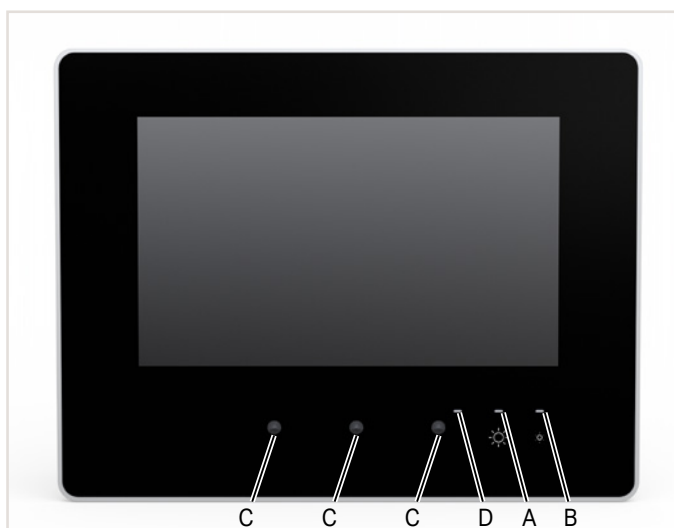


### Touch Panels Marine Line

In this version, WAGO's Touch Panels are ideal for marine applications. They have special marine approvals. The matt black surface prevents disturbing reflections.

Available sizes:

- 10.9 cm (4.3")
- 14.5 cm (5.7")
- 18 cm (7.0")
- 25.7 cm (10.1")



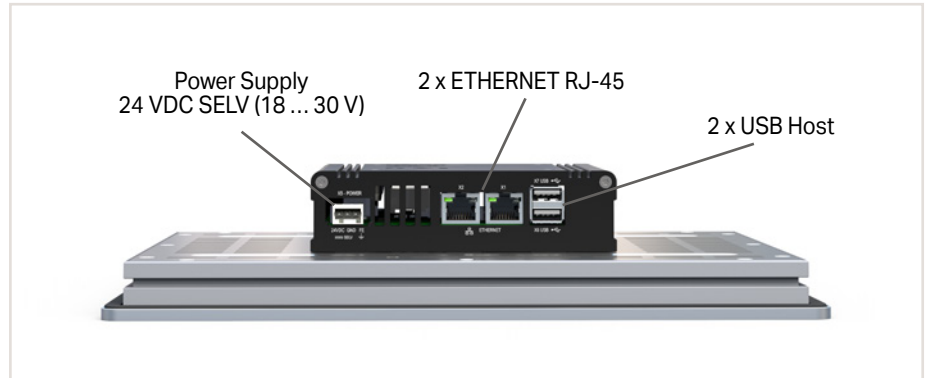


## Operation and Monitoring Interfaces and Types

### Hardware Configuration PIO1

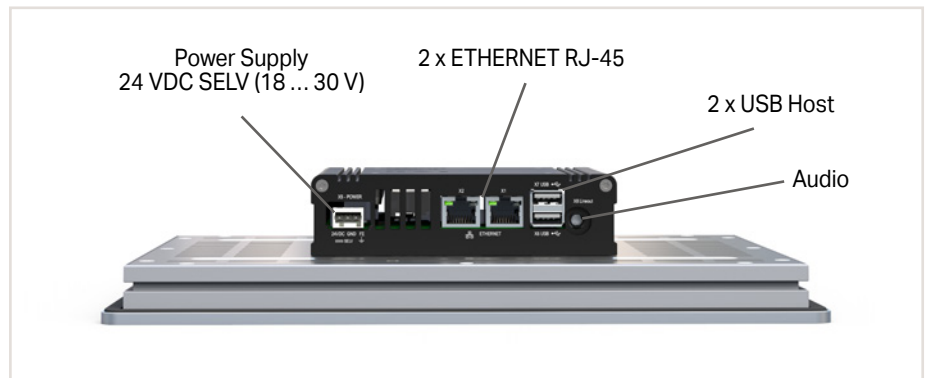
Besides the power supply connection, devices with the PIO1 hardware configuration provide:

- Two ETHERNET ports for connecting to field devices and the engineering tool
  - Two USB ports for optional connection of a USB stick, mouse or keyboard
- Devices of this type are primarily used as Web Panels.



### Hardware Configuration PIO2

The PIO2 hardware configuration contains the same connections as PIO1 hardware. In addition, the devices are equipped with an audio interface for connecting headphones or a loudspeaker. Devices of this type are primarily used as Visu Panels.

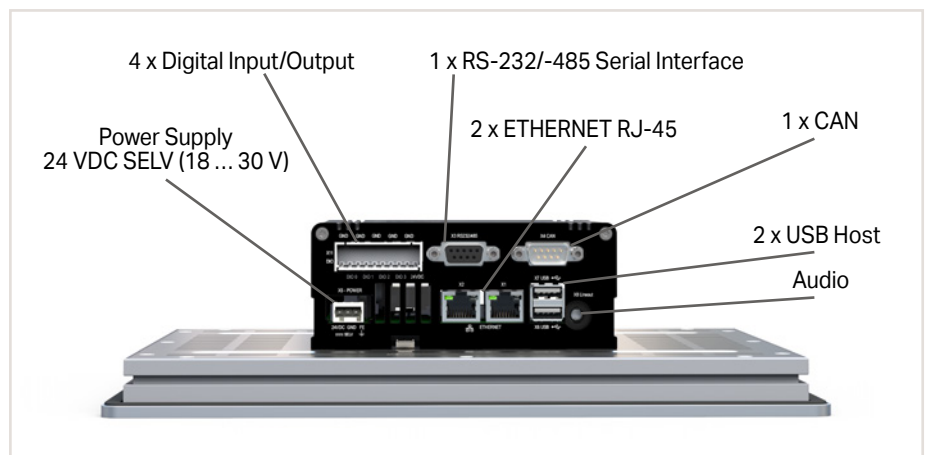


### Hardware Configuration PIO3

Devices of this type are primarily used as Control Panels. Besides the interfaces of the PIO2 configuration, they also have the following interfaces:

- CAN for controlling field devices
- RS-232/-485 interface for controlling field devices with a serial interface
- Four digital inputs/outputs for reading/trig-gering digital signals

In addition, this hardware configuration has a rapid, power-failure-proof storage component that can back up retain variables of the controller without additional UPS measures.



### Common Control Elements

The following control elements are provided on the side of the devices:

#### Touch Panels 600:

- Run/Stop switch (only relevant for Control Panels)
- Service Switch
- Five LEDs for signaling:
  - General device states
  - Special states of the PLC runtime environment
  - States of the fieldbus connections
- One microSD card for data exchange

#### Touch Panels e!DISPLAY:

- One microSD card for data exchange



## Operation and Monitoring Application and Installation Instructions

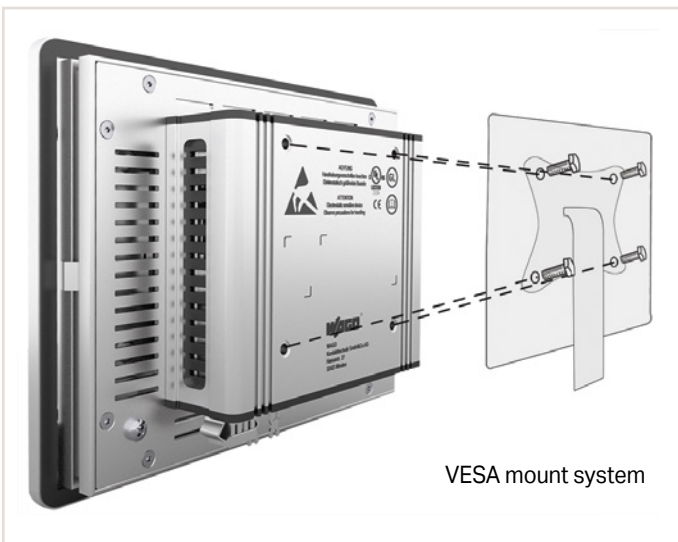
3



Two brightness adjustment keys are located directly on the front of the device, along with three diagnostics LEDs.

### Mounting

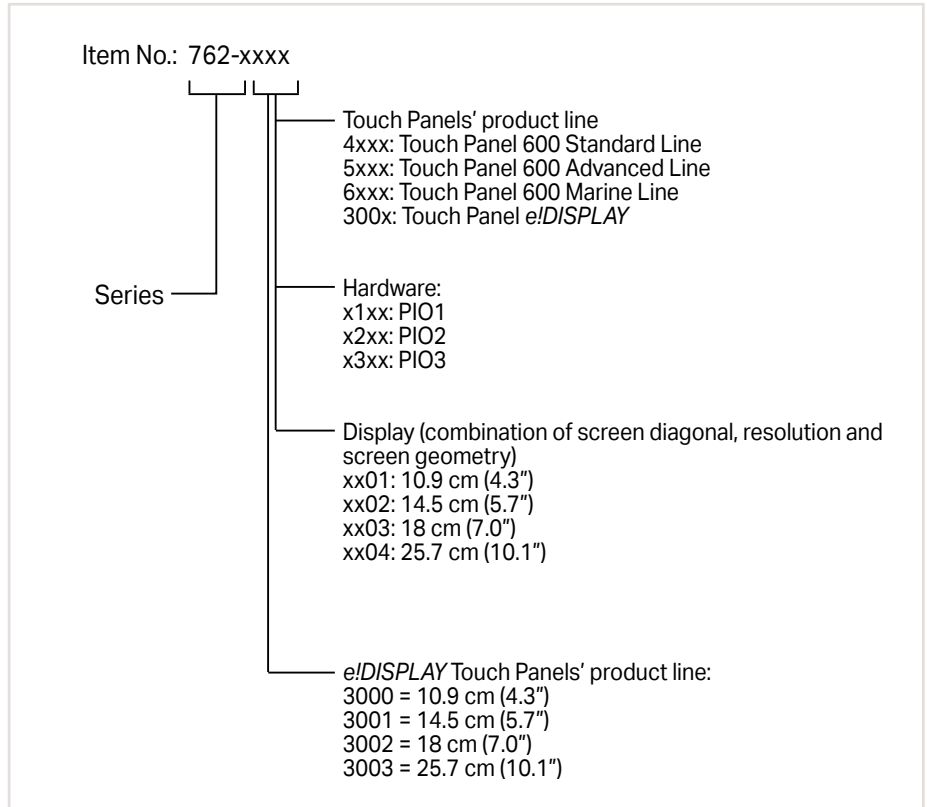
WAGO's Touch Panel directly latches onto the control cabinet via mounting spring clips for quick and easy tool-free installation. IP65 levels of protection can be achieved for the front of the display via additional clamping screws. This design flexibility makes the display extremely versatile and suitable for a wide variety of applications.



The VESA mount (VESA 75 standard, 75 mm hole spacing) allows universal mounting accessories to be conveniently used outside of the control cabinet.

## Operation and Monitoring Item Number Key

Explanation of item number key's components



3

## Standards and Rated Conditions

### General Specifications

Operating system	Linux®
Control elements	Resistive touch panel; Two capacitive keys; Proximity switch
Durability	100,000 activations with touch pen
Power Supply	24 VDC, SELV (-25 ... +30 %) with reverse voltage protection
Indicators	Diagnostic indication (LED)
Surrounding air temperature (operation)	0 ... +55 °C
Surrounding air temperature (storage)	-20 ... +80 °C
Relative humidity	10 ... 90 %; non-condensing
Protection type	IP65 (front side); IP20 (rear side)

## Approvals

Overview of the approvals in the article comparison in Section 11, Technical Appendix, or online at [www.wago.com](http://www.wago.com)



## Touch Panel 600 Standard Line; Resistive Touchscreen; 10.9 cm (4.3")

3



<b>Item Description</b>	Touch Panel; 10.9 cm (4.3"); 480 x 272 pixels; Resistive touchscreen		
<b>Version</b>	<b>Hardware configuration PIO3; Control Panel</b>	<b>Hardware configuration PIO2; Visu Panel</b>	<b>Hardware configuration PIO1; Web Panel</b>
<b>Item No.</b>	762-4301/8000-002	762-4201/8000-001	762-4101
<b>Order Text</b>	TP600; 4.3; 480x272; PIO3; CP	TP600; 4.3; 480x272; PIO2; VP	TP600; 4.3; 480x272; PIO1; WP

<b>Technical Data</b>	Resistive touchscreen		
Display/front view	10.9 cm (4.3")		
Screen size (diagonal)	16:9		
Aspect	16 million		
Display colors	480 x 272		
Graphics resolution	Two brightness settings (Up and Down) on the front		
Operating elements	Modbus® (TCP)		
Communication	EtherNet/IP adapter (slave) <sup>1</sup> ; CANopen; Modbus® (UDP); RS-232/485 interface; MQTT		
ETHERNET protocols	DHCP; DNS; FTP; FTPS; HTTP; HTTPS; SSH		
Programming environment	e!COCKPIT (based on CODESYS V3)		
Operating system	Real-time Linux (with RT-Preempt patch)		
Processor	Cortex A9		
Main memory (RAM)/internal memory (flash)	2 GB / 4 GB		
Program memory/data memory/non-volatile memory (software)	60 MB* / 60 MB* / 128 KB	60 MB* / 60 MB* / -	
Memory expansion	microSD (max. 2 GB); microSDHC (max. 32 GB)		
Interfaces (USB)	2 x USB host 2.0 (type A)		
Onboard I/Os	Audio; 4 x DIO, configurable	Audio	
Dimensions (W x H x D)	155 x 135 x 78 mm	155 x 135 x 58 mm	
Panel cutout (W x H)	140 x 120 mm		
Mounting	Clamping elements (included) or VESA mount (4 x M4x8)		
Supply voltage	24 VDC, SELV (-25 ... +30 %) with reverse voltage protection		
Surrounding air temperature (operation)	0 ... +55 °C		
<b>Approvals</b>	CE; OrdLoc**		
<b>Data sheet and further information, see:</b>	<a href="http://wago.com/762-4301/8000-002">wago.com/762-4301/8000-002</a>	<a href="http://wago.com/762-4201/8000-001">wago.com/762-4201/8000-001</a>	<a href="http://wago.com/762-4101">wago.com/762-4101</a>

<b>Accessories</b>	<b>Item No.</b>	<b>Page</b>
Memory card; 2 GB	758-879/000-3102	68
Clamping elements (included)	762-9001	68

<sup>1</sup> Library for e!RUNTIME

\*For memory configuration via e!RUNTIME, the program and data memory together have a maximum size of 60 MB and can be distributed dynamically.

\*\*Pending

## Touch Panel 600 Standard Line; Resistive Touchscreen; 14.5 cm (5.7")



<b>Item Description</b>	<b>Touch Panel; 14.5 cm (5.7"); 640 x 480 pixels; Resistive touchscreen</b>		
<b>Version</b>	<b>Hardware configuration PIO3; Control Panel</b>	<b>Hardware configuration PIO2; Visu Panel</b>	<b>Hardware configuration PIO1; Web Panel</b>
<b>Item No.</b>	762-4302/8000-002	762-4202/8000-001	762-4102
<b>Order Text</b>	TP600; 5.7; 640x480; PIO3; CP	TP600; 5.7; 640x480; PIO2; VP	TP600; 5.7; 640x480; PIO1; WP

<b>Technical Data</b>			
Display/front view	Resistive touchscreen		
Screen size (diagonal)	14.5 cm (5.7")		
Aspect	4:3		
Display colors	262.000		
Graphics resolution	640 x 480		
Operating elements	Two brightness settings (Up and Down) on the front		
Communication	Modbus® (TCP)		
	EtherNet/IP adapter (slave) <sup>1</sup> ; CANopen; Modbus® (UDP); RS-232/485 interface; MQTT		
ETHERNET protocols	DHCP; DNS; FTP; FTPS; HTTP; HTTPS; SSH		
Programming environment	e!COCKPIT (based on CODESYS V3)		
Operating system	Real-time Linux (with RT-Preempt patch)		
Processor	Cortex A9		
Main memory (RAM)/internal memory (flash)	2 GB / 4 GB		
Program memory/data memory/non-volatile memory (software)	60 MB* / 60 MB* / 128 KB	60 MB* / 60 MB* / -	
Memory expansion	microSD (max. 2 GB); microSDHC (max. 32 GB)		
Interfaces (USB)	2 x USB host 2.0 (type A)		
Onboard I/Os	Audio; 4 x DIO, configurable	Audio	
Dimensions (W x H x D)	172 x 163 x 78 mm	172 x 163 x 58 mm	
Panel cutout (W x H)	157 x 148 mm		
Mounting	Clamping elements (included) or VESA mount (4 x M4x8)		
Supply voltage	24 VDC, SELV (-25 ... +30 %) with reverse voltage protection		
Surrounding air temperature (operation)	0 ... +55 °C		
Approvals	CE; OrdLoc**		
<b>Data sheet and further information, see:</b>	<a href="http://wago.com/762-4302/8000-002">wago.com/762-4302/8000-002</a>	<a href="http://wago.com/762-4202/8000-001">wago.com/762-4202/8000-001</a>	<a href="http://wago.com/762-4102">wago.com/762-4102</a>

<b>Accessories</b>	<b>Item No.</b>	<b>Page</b>
Memory card; 2 GB	758-879/000-3102	68
Clamping elements (included)	762-9001	68

<sup>1</sup>Library for e!RUNTIME

\*For memory configuration via e!RUNTIME, the program and data memory together have a maximum size of 60 MB and can be distributed dynamically.

\*\*Pending

## Touch Panel 600 Standard Line; Resistive Touchscreen; 17.8 cm (7.0")



<b>Item Description</b>	Touch Panel; 17.8 cm (7.0"); 800 x 480 pixels; Resistive touchscreen		
<b>Version</b>	<b>Hardware configuration PIO3; Control Panel</b>	<b>Hardware configuration PIO2; Visu Panel</b>	<b>Hardware configuration PIO1; Web Panel</b>
<b>Item No.</b>	762-4303/8000-002	762-4203/8000-001	762-4103
<b>Order Text</b>	TP600; 7.0; 800x480; PIO3; CP	TP600; 7.0; 800x480; PIO2; VP	TP600; 7.0; 800x480; PIO1; WP

### Technical Data

Display/front view	Resistive touchscreen		
Screen size (diagonal)	18 cm (7.0")		
Aspect	16:9		
Display colors	16 million		
Graphics resolution	800 x 480		
Operating elements	Two brightness settings (Up and Down) on the front		
Communication	Modbus® (TCP)		
ETHERNET protocols	DHCP; DNS; FTP; FTPS; HTTP; HTTPS; SSH		
Programming environment	e!COCKPIT (based on CODESYS V3)		
Operating system	Real-time Linux (with RT-Preempt patch)		
Processor	Cortex A9		
Main memory (RAM)/internal memory (flash)	2 GB / 4 GB		
Program memory/data memory/non-volatile memory (software)	60 MB* / 60 MB* / 128 KB	60 MB* / 60 MB* / -	
Memory expansion	microSD (max. 2 GB); microSDHC (max. 32 GB)		
Interfaces (USB)	2 x USB host 2.0 (type A)		
Onboard I/Os	Audio; 4 x DIO, configurable	Audio	
Dimensions (W x H x D)	213 x 167 x 78 mm	213 x 167 x 58 mm	
Panel cutout (W x H)	198 x 152 mm		
Mounting	Clamping elements (included) or VESA mount (4 x M4x8)		
Supply voltage	24 VDC, SELV (-25 ... +30 %) with reverse voltage protection		
Surrounding air temperature (operation)	0 ... +55 °C		
Approvals	CE; ® OrdLoc**		
<b>Data sheet and further information, see:</b>	<a href="http://wago.com/762-4303/8000-002">wago.com/762-4303/8000-002</a>	<a href="http://wago.com/762-4203/8000-001">wago.com/762-4203/8000-001</a>	<a href="http://wago.com/762-4103">wago.com/762-4103</a>

<b>Accessories</b>	<b>Item No.</b>	<b>Page</b>
Memory card; 2 GB	758-879/000-3102	68
Clamping elements (included)	762-9001	68

<sup>1</sup> Library for e!RUNTIME

\*For memory configuration via e!RUNTIME, the program and data memory together have a maximum size of 60 MB and can be distributed dynamically.

\*\*Pending

## Touch Panel 600 Standard Line; Resistive Touchscreen; 25.7 cm (10.1")



3

Item Description	Touch Panel; 25.7 cm (10.1"); 1280 x 800 pixels; Resistive touchscreen		
Version	Hardware configuration PIO3; Control Panel	Hardware configuration PIO2; Visu Panel	Hardware configuration PIO1; Web Panel
Item No.	762-4304/8000-002	762-4204/8000-001	762-4104
Order Text	TP600; 10.1; 1280x800; PIO3; CP	TP600; 10.1; 1280x800; PIO2; VP	TP600; 10.1; 1280x800; PIO1; WP
<b>Technical Data</b>			
Display/front view	Resistive touchscreen		
Screen size (diagonal)	25.7 cm (10.1")		
Aspect	16:9		
Display colors	16 million		
Graphics resolution	1280 x 800		
Operating elements	Two brightness settings (Up and Down) on the front		
Communication	Modbus® (TCP)		
ETHERNET protocols	DHCP; DNS; FTP; FTPS; HTTP; HTTPS; SSH		
Programming environment	e!COCKPIT (based on CODESYS V3)		
Operating system	Real-time Linux (with RT-Preempt patch)		
Processor	Cortex A9		
Main memory (RAM)/internal memory (flash)	2 GB / 4 GB		
Program memory/data memory/non-volatile memory (software)	60 MB* / 60 MB* / 128 KB	60 MB* / 60 MB* / -	
Memory expansion	microSD (max. 2 GB); microSDHC (max. 32 GB)		
Interfaces (USB)	2 x USB host 2.0 (type A)		
Onboard I/Os	Audio; 4 x DIO, configurable	Audio	
Dimensions (W x H x D)	293 x 223 x 78 mm	293 x 223 x 58 mm	
Panel cutout (W x H)	278 x 208 mm		
Mounting	Clamping elements (included) or VESA mount (4 x M4x8)		
Supply voltage	24 VDC, SELV (-25 ... +30 %) with reverse voltage protection		
Surrounding air temperature (operation)	0 ... +55 °C		
Approvals	CE; ; ®= OrdLoc**		
Data sheet and further information, see:	<a href="http://wago.com/762-4304/8000-002">wago.com/762-4304/8000-002</a>	<a href="http://wago.com/762-4204/8000-001">wago.com/762-4204/8000-001</a>	<a href="http://wago.com/762-4104">wago.com/762-4104</a>
<b>Accessories</b>			
Memory card; 2 GB	Item No.	Page	
	758-879/000-3102	68	
Clamping elements (included)	762-9001	68	

<sup>1</sup>Library for e!RUNTIME

\*For memory configuration via e!RUNTIME, the program and data memory together have a maximum size of 60 MB and can be distributed dynamically.

\*\*Pending

## Touch Panel 600 Advanced Line; Capacitive Touchscreen with a Glass Surface; 17.8 cm (7.0")

3



<b>Item Description</b>	<b>Touch Panel; 17.8 cm (7.0"); 800 x 480 pixels; Capacitive touchscreen with a glass surface</b>	
<b>Version</b>	<b>Hardware configuration PIO3; Control Panel</b>	<b>Hardware configuration PIO2; Visu Panel</b>
<b>Item No.</b>	<b>762-5303/8000-002</b>	<b>762-5203/8000-001</b>
<b>Order Text</b>	TP600; 7.0; 800x480; PIO3; CP	TP600; 7.0; 800x480; PIO2; VP
<b>Technical Data</b>		
Display/front view	Multitouch glass front; Capacitive touchscreen with a glass surface	
Screen size (diagonal)	18 cm (7.0")	
Aspect	16:9	
Display colors	16 million	
Graphics resolution	800 x 480	
Operating elements	Two brightness settings (Up and Down) on the front	
Communication	Modbus® (TCP)	
ETHERNET protocols	DHCP; DNS; FTP; FTPS; HTTP; HTTPS; SSH	
Programming environment	e!COCKPIT (based on CODESYS V3)	
Operating system	Real-time Linux (with RT-Preempt patch)	
Processor	Cortex A9	
Main memory (RAM)/internal memory (flash)	2 GB / 4 GB	
Program memory/data memory/non-volatile memory (software)	60 MB* / 60 MB* / 128 KB	60 MB* / 60 MB* / -
Memory expansion	microSD (max. 2 GB); microSDHC (max. 32 GB)	
Interfaces (USB)	2 x USB host 2.0 (type A)	
Onboard I/Os	Audio; 4 x DIO, configurable	Audio
Dimensions (W x H x D)	213 x 167 x 78 mm	213 x 167 x 58 mm
Panel cutout (W x H)	198 x 152 mm	
Mounting	Clamping elements (included) or VESA mount (4 x M4x8)	
Supply voltage	24 VDC, SELV (-25 ... +30 %) with reverse voltage protection	
Surrounding air temperature (operation)	0 ... +55 °C	
Approvals	CE;  OrdLoc**	
Data sheet and further information, see:	<a href="http://wago.com/762-5303/8000-002">wago.com/762-5303/8000-002</a>	<a href="http://wago.com/762-5203/8000-001">wago.com/762-5203/8000-001</a>
<b>Accessories</b>	<b>Item No.</b>	<b>Page</b>
Memory card; 2 GB	758-879/000-3102	68
Clamping elements (included)	762-9001	68

<sup>1</sup> Library for e!RUNTIME

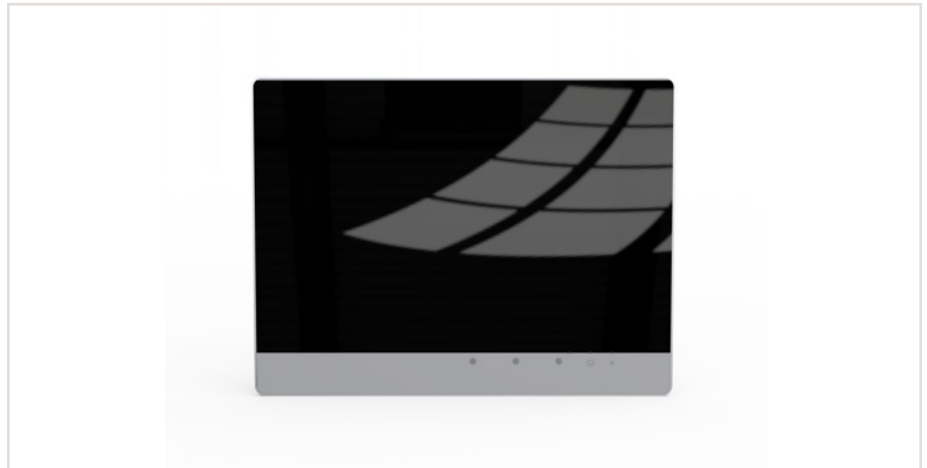
\*For memory configuration via e!RUNTIME, the program and data memory together have a maximum size of 60 MB and can be distributed dynamically.

\*\*Pending

„ Software e!COCKPIT, see page 26



## Touch Panel 600 Advanced Line; Capacitive Touchscreen with a Glass Surface; 25.7 cm (10.1")



3

Item Description	Touch Panel; 25.7 cm (10.1"); 1280 x 800 pixels; Capacitive touchscreen with a glass surface	
Version	Hardware configuration PIO3; Control Panel	Hardware configuration PIO2; Visu Panel
Item No.	762-5304/8000-002	762-5204/8000-001
Order Text	TP600; 10.1; 1280x800; PIO3; CP	TP600; 10.1; 1280x800; PIO2; VP
<b>Technical Data</b>		
Display/front view	Multitouch glass front; Capacitive touchscreen with a glass surface	
Screen size (diagonal)	25.7 cm (10.1")	
Aspect	16:9	
Display colors	16 million	
Graphics resolution	1280 x 800	
Operating elements	Two brightness settings (Up and Down) on the front	
Communication	Modbus® (TCP)	
ETHERNET protocols	EtherNet/IP adapter (slave) <sup>1</sup> ; CANopen; Modbus® (UDP); RS-232/485 interface; MQTT	
Programming environment	DHCP; DNS; FTP; FTPS; HTTP; HTTPS; SSH	
Operating system	e!COCKPIT (based on CODESYS V3)	
Processor	Real-time Linux (with RT-Preempt patch)	
Main memory (RAM)/internal memory (flash)	Cortex A9	
Program memory/data memory/non-volatile memory (software)	2 GB / 4 GB	
Memory expansion	60 MB* / 60 MB* / 128 KB	60 MB* / 60 MB* / -
Interfaces (USB)	microSD (max. 2 GB); microSDHC (max. 32 GB)	
Onboard I/Os	2 x USB host 2.0 (type A)	
Dimensions (W x H x D)	Audio; 4 x DIO, configurable	Audio
Panel cutout (W x H)	293 x 223 x 78 mm	293 x 223 x 58 mm
Mounting	278 x 208 mm	
Supply voltage	Clamping elements (included) or VESA mount (4 x M4x8)	
Surrounding air temperature (operation)	24 VDC, SELV (-25 ... +30 %) with reverse voltage protection	
Approvals	0 ... +55 °C	
Data sheet and further information, see:	CE; OrdLoc**	
	<a href="http://wago.com/762-5304/8000-002">wago.com/762-5304/8000-002</a>	<a href="http://wago.com/762-5204/8000-001">wago.com/762-5204/8000-001</a>
<b>Accessories</b>	<b>Item No.</b>	<b>Page</b>
Memory card; 2 GB	758-879/000-3102	68
Clamping elements (included)	762-9001	68

<sup>1</sup> Library for e!RUNTIME

\*For memory configuration via e!RUNTIME, the program and data memory together have a maximum size of 60 MB and can be distributed dynamically.

\*\*Pending

## Touch Panel 600 Marine Line; Resistive Touchscreen; 10.9 cm (4.3") or 14.5 cm (5.7")

3



<b>Item Description</b>	Touch Panel; 10.9 cm (4.3"); 480 x 272 pixels; Resistive touchscreen, marine version	Touch Panel; 14.5 cm (5.7"); 640 x 480 pixels; Resistive touchscreen, marine version												
<b>Version</b>	Hardware configuration PIO2; Visu Panel	Hardware configuration PIO2; Visu Panel												
<b>Item No.</b>	762-6201/8000-001	762-6202/8000-001												
<b>Order Text</b>	TP600; 4.3; 480x272; PIO2; VP	TP600; 5.7; 640x480; PIO2; VP												
<b>Technical Data</b>														
Display/front view	Resistive touchscreen; Black front	Resistive touchscreen; Black front												
Screen size (diagonal)	10.9 cm (4.3")	14.5 cm (5.7")												
Aspect	16:9	4:3												
Display colors	16 million	262.000												
Graphics resolution	480 x 272	640 x 480												
Operating elements	Two brightness settings (Up and Down) on the front	Two brightness settings (Up and Down) on the front												
Communication	Modbus® (TCP)	Modbus® (TCP)												
ETHERNET protocols	DHCP; DNS; FTP; FTPS; HTTP; HTTPS; SSH	DHCP; DNS; FTP; FTPS; HTTP; HTTPS; SSH												
Programming environment	e!COCKPIT (based on CODESYS V3)	e!COCKPIT (based on CODESYS V3)												
Operating system	Real-time Linux (with RT-Preempt patch)	Real-time Linux (with RT-Preempt patch)												
Processor	Cortex A9	Cortex A9												
Main memory (RAM)/internal memory (flash)	2 GB / 4 GB	2 GB / 4 GB												
Program memory/data memory	60 MB* / 60 MB*	60 MB* / 60 MB*												
Memory expansion	microSD (max. 2 GB); microSDHC (max. 32 GB)	microSD (max. 2 GB); microSDHC (max. 32 GB)												
Interfaces (USB)	2 x USB host 2.0 (type A)	2 x USB host 2.0 (type A)												
Onboard I/Os	Audio	Audio												
Dimensions (W x H x D)	155 x 135 x 58 mm	172 x 163 x 58 mm												
Panel cutout (W x H)	140 x 120 mm	157 x 148 mm												
Mounting	Clamping elements (included) or VESA mount (4 x M4x8)	Clamping elements (included) or VESA mount (4 x M4x8)												
Supply voltage	24 VDC, SELV (-25 ... +30 %); with reverse voltage protection	24 VDC, SELV (-25 ... +30 %); with reverse voltage protection												
Surrounding air temperature (operation)	0 ... +55 °C	0 ... +55 °C												
<b>Approvals</b>	CE; OrdLoc**; DNV GL**	CE; OrdLoc**; DNV GL**												
<b>Data sheet and further information, see:</b>	<a href="http://wago.com/762-6201/8000-001">wago.com/762-6201/8000-001</a>	<a href="http://wago.com/762-6202/8000-001">wago.com/762-6202/8000-001</a>												
<b>Accessories</b>	<table border="1"> <thead> <tr> <th>Item No.</th> <th>Page</th> </tr> </thead> <tbody> <tr> <td>758-879/000-3102</td> <td>68</td> </tr> <tr> <td>762-9001</td> <td>68</td> </tr> </tbody> </table>	Item No.	Page	758-879/000-3102	68	762-9001	68	<table border="1"> <thead> <tr> <th>Item No.</th> <th>Page</th> </tr> </thead> <tbody> <tr> <td>758-879/000-3102</td> <td>68</td> </tr> <tr> <td>762-9001</td> <td>68</td> </tr> </tbody> </table>	Item No.	Page	758-879/000-3102	68	762-9001	68
Item No.	Page													
758-879/000-3102	68													
762-9001	68													
Item No.	Page													
758-879/000-3102	68													
762-9001	68													

\*For memory configuration via e!RUNTIME, the program and data memory together have a maximum size of 60 MB and can be distributed dynamically.  
\*\*Pending

\*For memory configuration via e!RUNTIME, the program and data memory together have a maximum size of 60 MB and can be distributed dynamically.  
\*\*Pending

„ Software e!COCKPIT, see page 26  
„ Approvals and corresponding ratings, see page 528 or www.wago.com

## Touch Panel 600 Marine Line; Resistive Touchscreen; 17.8 cm (7.0") or 25.7 cm (10.1")



Item Description	Touch Panel; 17.8 cm (7.0"); 800 x 480 pixels; Resistive touchscreen, marine version	Touch Panel; 25.7 cm (10.1"); 1280 x 800 pixels; Resistive touchscreen, marine version
Version	Hardware configuration PIO2; Visu Panel	Hardware configuration PIO2; Visu Panel
Item No.	762-6203/8000-001	762-6204/8000-001
Order Text	TP600; 7.0; 800x480; PIO2; VP	TP600; 10.1; 1280x800; PIO2; VP
<b>Technical Data</b>		
Display/front view	Resistive touchscreen; Black front	Resistive touchscreen; Black front
Screen size (diagonal)	18 cm (7.0")	25.7 cm (10.1")
Aspect	16:9	16:9
Display colors	16 million	16 million
Graphics resolution	800 x 480	1280 x 800
Operating elements	Two brightness settings (Up and Down) on the front	Two brightness settings (Up and Down) on the front
Communication	Modbus® (TCP)	Modbus® (TCP)
ETHERNET protocols	DHCP; DNS; FTP; FTPS; HTTP; HTTPS; SSH	DHCP; DNS; FTP; FTPS; HTTP; HTTPS; SSH
Programming environment	<i>e!COCKPIT</i> (based on CODESYS V3)	<i>e!COCKPIT</i> (based on CODESYS V3)
Operating system	Real-time Linux (with RT-Preempt patch)	Real-time Linux (with RT-Preempt patch)
Processor	Cortex A9	Cortex A9
Main memory (RAM)/internal memory (flash)	2 GB / 4 GB	2 GB / 4 GB
Program memory/data memory	60 MB* / 60 MB*	60 MB* / 60 MB*
Memory expansion	microSD (max. 2 GB); microSDHC (max. 32 GB)	microSD (max. 2 GB); microSDHC (max. 32 GB)
Interfaces (USB)	2 x USB host 2.0 (type A)	2 x USB host 2.0 (type A)
Onboard I/Os	Audio	Audio
Dimensions (W x H x D)	213 x 167 x 58 mm	293 x 223 x 58 mm
Panel cutout (W x H)	198 x 152 mm	278 x 208 mm
Mounting	Clamping elements (included) or VESA mount (4 x M4x8)	Clamping elements (included) or VESA mount (4 x M4x8)
Supply voltage	24 VDC, SELV (-25 ... +30 %); with reverse voltage protection	24 VDC, SELV (-25 ... +30 %); with reverse voltage protection
Surrounding air temperature (operation)	0 ... +55 °C	0 ... +55 °C
Approvals	CE; Ⓜ OrdLoc**; DNV GL**	CE; Ⓜ OrdLoc**; DNV GL**
Data sheet and further information, see:	<a href="http://wago.com/762-6203/8000-001">wago.com/762-6203/8000-001</a>	<a href="http://wago.com/762-6204/8000-001">wago.com/762-6204/8000-001</a>
<b>Accessories</b>	<b>Item No.</b>	<b>Page</b>
Memory card; 2 GB	758-879/000-3102	68
Clamping elements (included)	762-9001	68

\*For memory configuration via *e!RUNTIME*, the program and data memory together have a maximum size of 60 MB and can be distributed dynamically.

\*\*Pending

\*For memory configuration via *e!RUNTIME*, the program and data memory together have a maximum size of 60 MB and can be distributed dynamically.

\*\*Pending

## Touch Panel e!DISPLAY 3000T; Resistive Touchscreen; 10.9 cm (4.3") or 14.5 cm (5.7")

3



<b>Item Description</b>	Touch Panel; 10.9 cm (4.3"); 480 x 272 pixels; Resistive touchscreen	Touch Panel; 14.5 cm (5.7"); 640 x 480 pixels; Resistive touchscreen
<b>Version</b>	Hardware configuration PIO1; Web Panel	Hardware configuration PIO1; Web Panel
<b>Item No.</b>	762-3000	762-3001
<b>Order Text</b>	WP; 4.3; 480x272; PIO1	WP; 5.7; 640x480; PIO1
<b>Technical Data</b>		
Display/front view	Resistive touchscreen	Resistive touchscreen
Screen size (diagonal)	10.9 cm (4.3")	14.5 cm (5.7")
Aspect	16:9	4:3
Display colors	16 million	262.000
Graphics resolution	480 x 272	640 x 480
Operating elements	Two brightness settings (Up and Down) on the front	Two brightness settings (Up and Down) on the front
ETHERNET protocols	DHCP; DNS; FTP; FTPS; HTTP; HTTPS; SSH	DHCP; DNS; FTP; FTPS; HTTP; HTTPS; SSH
Operating system	Real-time Linux (with RT-Preempt patch)	Real-time Linux (with RT-Preempt patch)
Processor	Cortex A8	Cortex A8
Main memory (RAM)/internal memory (flash)	512 Mb / 1024 Mb	512 Mb / 1024 Mb
Memory expansion	microSD (max. 2 GB); microSDHC (max. 32 GB)	microSD (max. 2 GB); microSDHC (max. 32 GB)
Interfaces (USB)	2 x USB host 2.0 (type A)	2 x USB host 2.0 (type A)
Dimensions (W x H x D)	155 x 135 x 58 mm	172 x 163 x 58 mm
Panel cutout (W x H)	140 x 120 mm	157 x 148 mm
Mounting	Clamping elements (included) or VESA mount (4 x M4x8)	Clamping elements (included) or VESA mount (4 x M4x8)
Supply voltage	24 VDC, SELV (-25 ... +30 %); with reverse voltage protection	24 VDC, SELV (-25 ... +30 %); with reverse voltage protection
Surrounding air temperature (operation)	0 ... +55 °C	0 ... +55 °C
Approvals	CE;  OrdLoc; DNV GL	CE;  OrdLoc; DNV GL
Data sheet and further information, see:	<a href="http://wago.com/762-3000">wago.com/762-3000</a>	<a href="http://wago.com/762-3001">wago.com/762-3001</a>
<b>Accessories</b>	<b>Item No.</b> <b>Page</b>	<b>Item No.</b> <b>Page</b>
Memory card; 2 GB	758-879/000-3102      68	758-879/000-3102      68
Clamping elements (included)	762-9001      68	762-9001      68

\* Approvals and corresponding ratings, see page 528 or [www.wago.com](http://www.wago.com)

## Touch Panel e!DISPLAY 300T; Resistive Touchscreen; 17.8 cm (7.0") or 25.7 cm (10.1")



<b>Item Description</b>	Touch Panel; 17.8 cm (7.0"); 800 x 480 pixels; Resistive touchscreen	Touch Panel; 25.7 cm (10.1"); 1280 x 800 pixels; Resistive touchscreen
<b>Version</b>	Hardware configuration PIO1; Web Panel	Hardware configuration PIO1; Web Panel
<b>Item No.</b>	762-3002	762-3003
<b>Order Text</b>	WP; 7.0; 800x480; PIO1	WP 10.1 1280x800 PIO1
<b>Technical Data</b>		
Display/front view	Resistive touchscreen	Resistive touchscreen
Screen size (diagonal)	18 cm (7.0")	25.7 cm (10.1")
Aspect	16:9	16:9
Display colors	16 million	16 million
Graphics resolution	800 x 480	1280 x 800
Operating elements	Two brightness settings (Up and Down) on the front	Two brightness settings (Up and Down) on the front
ETHERNET protocols	DHCP; DNS; FTP; FTPS; HTTP; HTTPS; SSH	DHCP; DNS; FTP; FTPS; HTTP; HTTPS; SSH
Operating system	Real-time Linux (with RT-Preempt patch)	Real-time Linux (with RT-Preempt patch)
Processor	Cortex A8	Cortex A8
Main memory (RAM)/internal memory (flash)	512 Mb / 1024 Mb	512 Mb / 1024 Mb
Memory expansion	microSD (max. 2 GB); microSDHC (max. 32 GB)	microSD (max. 2 GB); microSDHC (max. 32 GB)
Interfaces (USB)	2 x USB host 2.0 (type A)	2 x USB host 2.0 (type A)
Dimensions (W x H x D)	213 x 167 x 58 mm	293 x 223 x 58 mm
Panel cutout (W x H)	198 x 152 mm	278 x 208 mm
Mounting	Clamping elements (included) or VESA mount (4 x M4x8)	Clamping elements (included) or VESA mount (4 x M4x8)
Supply voltage	24 VDC, SELV (-25 ... +30 %); with reverse voltage protection	24 VDC, SELV (-25 ... +30 %); with reverse voltage protection
Surrounding air temperature (operation)	0 ... +55 °C	0 ... +50 °C, 0 ... +55 °C (vertical mounting position)
Approvals	CE; RoHS; OrdLoc; DNV GL	CE; RoHS; OrdLoc; DNV GL
Data sheet and further information, see:	<a href="http://wago.com/762-3002">wago.com/762-3002</a>	<a href="http://wago.com/762-3003">wago.com/762-3003</a>
<b>Accessories</b>	<b>Item No.</b>	<b>Page</b>
Memory card; 2 GB	758-879/000-3102	68
Clamping elements (included)	762-9001	69
	<b>Item No.</b>	<b>Page</b>
	758-879/000-3102	68
	762-9001	68

## Accessories



3

<b>Item Description</b>	<b>Memory Card microSD; SLC-NAND; 2 GB; Temperature range: -40 ... +90 °C</b>
<b>Item No.</b>	<b>758-879/000-3102</b>
<b>Technical Data</b>	
Memory	2 GB (SLC)
Read/write cycles (max.)	17 MB/s / 20 MB/s
MTBF	4,000,000 hrs.
Service life	2,000,000 program/operating cycles
Surrounding air temperature (operation)	-40 ... +90 °C
Surrounding air temperature (storage)	-40 ... +90 °C
Relative humidity	95 % non-condensing
Dimensions W x H x D	15 x 11 x 1 mm
Vibration resistance	15 g
Shock resistance	50 g
Data transmission rate	Up to 20 Mb/s



<b>Connecting Cable</b>		
USB A-B	<b>Item No.</b>	<b>Pack. Unit</b>
3 m	758-879/000-101	1

<b>Clamping Element; for Touch Panels</b>		
	<b>Item No.</b>	<b>Pack. Unit</b>
4 pcs	762-9001	1





# Controllers

## Touch-Panel 600 Standard/Advanced Line; Hardware configuration Control Panel

- Merging of control and visualization
- 10.9 ... 25.7 cm (4.3 ... 10.1")

◀ Section 3

## Controllers PFC100/PFC200

- Maximum performance in a minimum space
- Also programmable in high-level languages based on Linux®
- Security packages with SSH and SSL/TLS
- Runtime system for CODESYS V2 (only PFC200) and V3

Section 4.1 ▶

## Controllers PFC200 XTR

The advantages of the PFC Controller combined with the capabilities for extreme environments:

- High processing speed
- Multiple interfaces
- eXTRemely robust and maintenance-free

Section 4.2 ▶▶

## Controllers 750

- Controllers for all prominent fieldbus systems
- Programmable to IEC 61131-3
- Combinable with the modules of the WAGO-I/O-SYSTEM 750

Section 4.3 ▶▶▶

## Controllers 750 XTR

For demanding applications in which the following are critical:

- Extreme temperature stability
- Immunity to electromagnetic interference and impulse voltages
- Vibration and shock resistance

Section 4.4 ▶▶▶▶

## Starter Kits







To get you up and running quickly, we offer starter kits to suit the most diverse applications:

- With Controller PFC100
- With Controller PFC200
- With Controller 750 ETHERNET
- With Controller 750 KNX IP or BACnet/IP

Section 4.5 ▶▶▶▶▶



## Controllers Overview

	Section	Page
	<b>3</b>	58
<b>Touch-Panel 600 Standard/Advanced Line; Hardware configuration Control Panel</b> Combining controller and visualization into one device		
	<b>4.1</b>	72
<b>Controllers PFC100 and PFC200</b> Scalable IP20 controller family with various interfaces		
	<b>4.2</b>	94
<b>Controllers PFC200 XTR</b> Scalable IP20 controllers with various interfaces for eXTReme environmental conditions		
	<b>4.3</b>	102
<b>Controllers 750</b> IP20 microcontrollers		
	<b>4.4</b>	120
<b>Controllers 750 XTR</b> IP20 microcontrollers for eXTReme environments		
	<b>4.5</b>	128
<b>Starter Kits</b> To get you up and running quickly, we offer starter kits to suit the most diverse applications.		

### Advantages:

- Fieldbus-independent – Support all standard fieldbus protocols and ETHERNET standards
- Scalable performance – Controllers, Control Panels, PFC100 and PFC200
- Programming per IEC 61131-3
- Flexible platform adapts to diverse applications and environments
- Combinable with the WAGO-I/O-SYSTEM 750 – Modular, compact, versatile



# Controllers PFC100/PFC200

## Touch-Panel 600 Standard/Advanced Line; Hardware configuration Control Panel

- Merging of control and visualization
- 10.9 ... 25.7 cm (4.3 ... 10.1")

◀ Section 3

## Controllers PFC200 XTR

The advantages of the PFC Controller combined with the capabilities for extreme environments:

- High processing speed
- Multiple interfaces
- eXTRemely robust and maintenance-free

Section 4.2 ▶

## Controllers 750 XTR

For demanding applications in which the following are critical:

- Extreme temperature stability
- Immunity to electromagnetic interference and impulse voltages
- Vibration and shock resistance

Section 4.4 ▶▶▶

## Controllers PFC100/PFC200

- Maximum performance in a minimum space
- Also programmable in high-level languages based on Linux®
- Security packages with SSH and SSL/TLS
- Runtime system for CODESYS V2 (only PFC200) and V3

Section 4.3 ▶▶

## Controllers 750

- Controllers for all prominent fieldbus systems
- Programmable to IEC 61131-3
- Combinable with the modules of the WAGO-I/O-SYSTEM 750

## Starter Kits

To get you up and running quickly, we offer starter kits to suit the most diverse applications:













- With Controller PFC100
- With Controller PFC200
- With Controller 750 ETHERNET
- With Controller 750 KNX IP or BACnet/IP

Section 4.5 ▶▶▶▶

# Controllers PFC100/PFC200

## Contents

General Product Information	74
Versions	75
Interfaces and Types	75
Installation Instructions	76
Item Number Key	76
Standards and Rated Conditions	77
Approvals	77

CPU	Modbus (TCP, UDP)	EtherNet/IP	EtherCAT	PROFINET	PROFIBUS	CANopen	Modbus RTU	Telecontrol protocols	IoT Protocols	Description	Item No.		Page	
											Default	Ext. Temperature		
 Cortex A8; 600 MHz	M/S	S								x	Controller PFC100; 2 x ETHERNET; Eco	750-8100		78
 Cortex A8; 600 MHz	M/S	S								x	Controller PFC100; 2 x ETHERNET	750-8101	750-8101/025-000	79
	M/S	S								x	Controller PFC100; 2 x ETHERNET, RS-232/-485	750-8102	750-8102/025-000	79
 Cortex A8; 1 GHz	M/S	S	M*							x	Controller PFC200; 2nd generation; 2 x ETHERNET, RS-232/-485	750-8212	750-8212/025-000	80
	M/S							x	x	x	Controller PFC200; 2nd generation; 2 x ETHERNET, RS-232/-485; Telecontrol technology		750-8212/025-001 750-8212/025-002	80
 Cortex A8; 1 GHz	M/S	S	M*			M/S				x	Controller PFC200; 2nd generation; 2 x ETHERNET, CAN, CANopen	750-8213		81
 Cortex A8; 1 GHz	M/S	S	M*			M/S				x	Controller PFC200; 2nd generation; 2 x ETHERNET, RS-232/-485, CAN, CANopen	750-8214		82
 Cortex A8; 1 GHz	M/S	S	M*	S		M/S				x	Controller PFC200; 2nd generation; 4 x ETHERNET, CAN, CANopen, USB	750-8215		83
 Cortex A8; 1 GHz	M/S	S	M*		S	M/S				x	Controller PFC200; 2nd generation; 2 x ETHERNET, RS-232/-485, CAN, CANopen, PROFIBUS Slave	750-8216	750-8216/025-000	84
	M/S				S	M/S		x	x	x	Controller PFC200; 2nd generation; 2 x ETHERNET, RS-232/-485, CAN, CANopen, PROFIBUS Slave; Telecontrol technology		750-8216/025-001	84
 Cortex A8; 600 MHz	M/S	S								x	Controller PFC200; 2 x ETHERNET, RS-232/-485, Mobile radio module	750-8207	750-8207/025-000	85
	M/S									x	Controller PFC200; 2 x ETHERNET, RS-232/-485, Mobile radio module; Telecontrol technology; Ext. temperature		750-8207/025-001	85
 Cortex A8; 600 MHz	M/S	S			M					x	Controller PFC200; 2 x ETHERNET, RS-232/-485, CAN, CANopen, PROFIBUS Master	750-8208	750-8208/025-000	86
	M/S				M					x	Controller PFC200; 2 x ETHERNET, RS-232/-485, CAN, CANopen, PROFIBUS Master; Telecontrol technology		750-8208/025-001	86
 Cortex A8; 600 MHz	M/S	S								x	Controller PFC100; FG0; 2 x ETHERNET	750-8101/000-010		89
 Cortex A8; 600 MHz	M/S	S								x	Controller PFC200; FG1; 2 x ETHERNET, RS-232/-485	750-8202/000-011		90
	M/S	S								x	Controller PFC200; FG2; 2 x ETHERNET, RS-232/-485	750-8202/000-012		91
	M/S	S								x	Controller PFC200; Energy data management application; 2 x ETHERNET; RS-232/-485	750-8202/000-022		92
 Cortex A8; 600 MHz	M/S	S								x	Controller PFC200; Energy data management application; 2 x ETHERNET, RS-232/-485; Mobile radio module	750-8207/000-022		93

M: Master, S: Slave; \*requires an additional license

## Controllers PFC100/PFC200

### General Product Information

#### PFC100/PFC200: Maximum Performance in a Minimum Space

As a member of the WAGO control family, the PFC100 and PFC200 Controllers with *e!RUNTIME* excel with high processing speed and multiple interfaces for parallel communication. They offer at least two ETHERNET connections in all variants and, depending on the version, additional interfaces. The CANopen, PROFIBUS DP, Modbus TCP/UPD/RTU, PROFINET, EtherNet/IP and EtherCAT protocols provide a flexible connection to fieldbus systems and external input/output devices. These fieldbus systems can be easily configured directly in WAGO's easy-to-use *e!COCKPIT* development environment.

The ETHERNET interfaces with an integrated switch also support all major IT protocols. In addition to multiple interfaces, the PFC100/PFC200 offers ample memory for your applications thanks to the internal Flash memory and an integrated interface for memory cards.

#### Industry 4.0 / IoT

Recording, digitizing and linking data profitably – this is the core concept behind Industry 4.0. Using a dedicated library, the WAGO PFC100 and PFC200 Controllers become IoT controllers that send data from the field level to the cloud. Here, they can be aggregated and used for analysis. This creates true added value for your company – be it for increasing the efficiency of in-house production, implementing energy management in buildings, or developing further end customer services. Existing systems also become IoT-ready, making them sustainable into the future. The WAGO PFC family of controllers thus forms the basis for a sustainable corporate world.

#### Telecontrol Technology

Standardized telecontrol protocols according to IEC 60870-5, IEC 61850, IEC 61400-25 or DNP3 ensure use of the PFC Controllers in telecontrol technology.

#### Starter Kits

For a quick start, WAGO offers every customer the unique opportunity to purchase a starter kit that already contains all the components needed to begin programming and getting to know the controllers. For starter kits, see Section 4.5.

#### Link between Process Data and IT Application

The PFC100/PFC200 ideally combines real-time requirements with IT functionality. It supports both MODBUS/TCP and ETHERNET/IP for use in industrial environments. HTTP, SNMP, FTP, BootP, DHCP, DNS, Telnet, SSH and other protocols simplify integration into IT environments. Integrated Web pages and Web-based visualization provide IT applications with real-time process data. Furthermore, the 750 Series Controllers incorporate library functions for email, SOAP, ASP, IP configuration, ETHERNET sockets and file system.

#### Security on Board

The topics of ETHERNET communication and security are closely linked. To provide PFC Controller users with a high level of security, mechanisms for secure connections such as VPN, integrated firewall, HTTPS, FTPS, SSH and SSL/TLS are standard.

#### Demand-Oriented Extensibility

Some controllers offer the option of activating functions that go beyond the standard via runtime licenses, making it possible to price as needed. This also offers the advantage that with the same exact controller, different functions can be realized and also combined, which otherwise would only be replicated via additional variants. The licenses are simply loaded into the controller together with the project. The additional licenses available for each controller are specified by the controller and described in detail in the "Software" section.

#### Application Controllers

For some specific solutions, variants of standard controllers are available that must be paired with the appropriate solutions. You will find these solutions in Section 1.

#### Modular and Expandable

With the WAGO I/O-SYSTEM 750, the PFC100/PFC200 can be expanded to almost any input/output interface. A modular, DIN-rail-mount design permits easy installation, expansion and modification of the I/O node without tools. The straightforward design prevents installation errors. In addition, proven CAGE CLAMP® technology offers fast, vibration-proof and maintenance-free connections that are independent of operator skill. Depending on the I/O module's granularity, field levels can be directly wired using 1-, 2-, 3- or 4-wire technology.

#### Maximum Reliability and Ruggedness

The PFC100/PFC200 is engineered and tested for use in the most demanding environments (e.g., temperature cycling, shock/vibration loading and ESD) according to the highest standards. Spring pressure connection technology guarantees continuous operation. Integrated QA measures in the production process and 100% function testing ensure consistent quality.

#### Open-Source Software and Linux®

We unite what belongs together: High-performance WAGO hardware and the future-ready Linux® operating system. WAGO's controllers offer programming in either IEC 61131 or directly in Linux® to create complex tasks. WAGO's "Embedded Linux" Controllers impress with base images that are expandable via open-source packages. As a "Gold Member" of the Open Source Automation Development Lab (OSADL), WAGO supports both financing and further development of Linux® in the industrial sector. The controller firmware itself is available as a "Board Support Package" (BSP). If you are interested, simply contact our Technical Support *AUTOMATION*.

#### Advantages:

- Programming per IEC 61131-3
- Applications with higher-level languages
- Linux® real-time operating system
- Robust and maintenance-free
- Integrated cybersecurity packages
- IoT ready

# Controllers PFC100/PFC200 Versions

## Extended Temperature Range

Industrial automation technology is typically operated in temperatures ranging from 0°C to 55°C. However, there are applications like telecontrol technology that require an extended temperature range. These versions are available in an extended temperature range of -20°C to +60°C.



## Eco

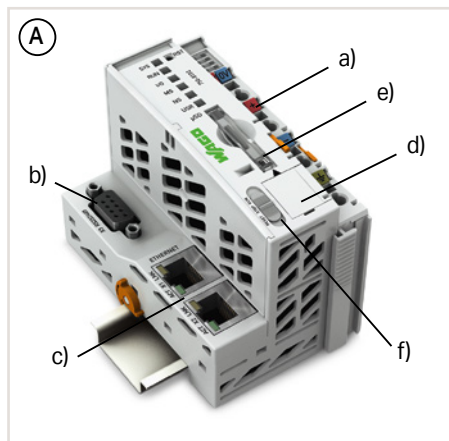
The Eco version of the PFC200 limits the number of stackable I/O modules to four.

## Telecontrol Technology

The telecontrol technology versions of the PFC200 are distinguished by their integrated, standardized telecontrol technology:

- IEC 60870-5
- IEC 61850
- IEC 61400-25
- DNP3

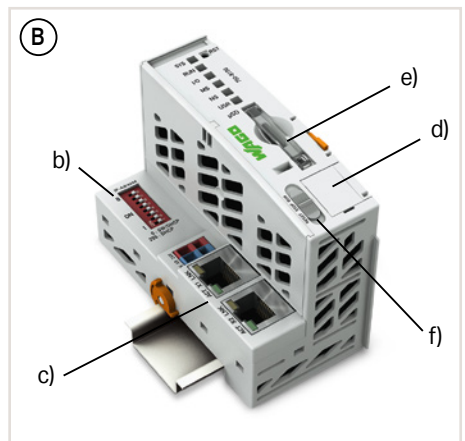
## Interfaces and Types



- Including supply module to power downstream I/O modules (a)
- Technical differences on the connection level (b)
- ETHERNET 2 x RJ-45 (c)
- Service interface (d)

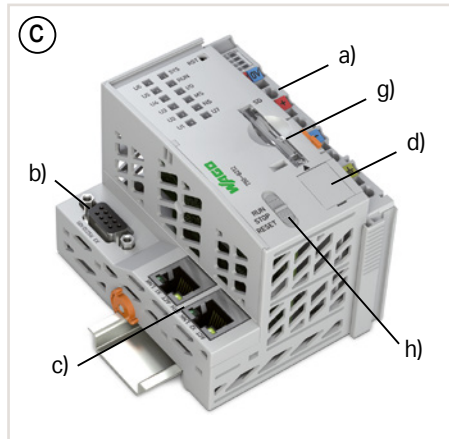
### Housing design (A)

- microSD card slot for external storage media (e)
- Start/stop switch (f)
- W x H x D (mm) 61.5 x 71.9 x 100
- Connection technology (system/field supply): CAGE CLAMP®
- Conductor cross section: 0.08 ... 2.5 mm²/28 ... 14 AWG



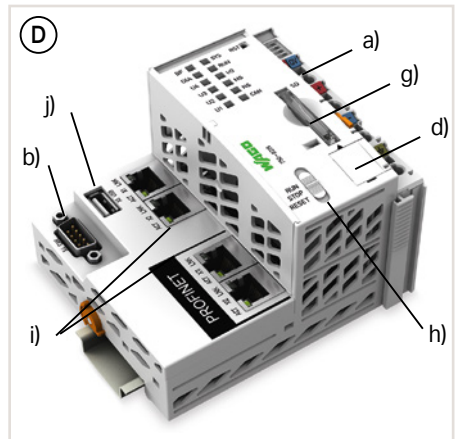
### Housing design (B)

- microSD card slot for external storage media (e)
- Start/stop switch (f)
- W x H x D (mm) 49.5 x 71.9 x 96.8
- Connection technology (system supply): CAGE CLAMP®
- Conductor cross section: 0.08 ... 1.5 mm²/28 ... 16 AWG



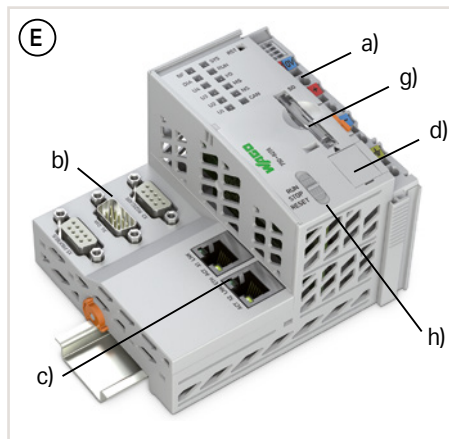
### Housing design (C)

- SD card slot for external storage media (g)
- Start/stop switch (h)
- W x H x D (mm) 78.6 x 71.9 x 100
- Connection technology (system/field supply): CAGE CLAMP®
- Conductor cross section: 0.08 ... 2.5 mm²/28 ... 14 AWG



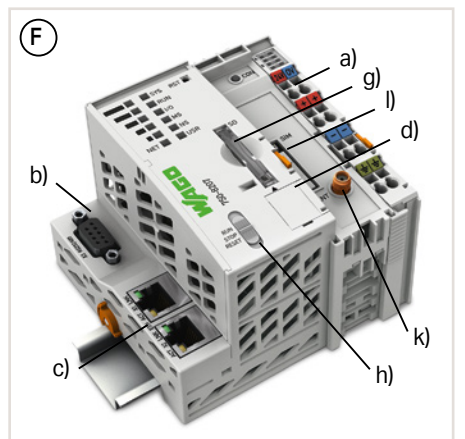
### Housing design (D)

- SD card slot for external storage media (g)
- Start/stop switch (h)
- ETHERNET 4 x RJ-45 (i)
- USB interface (j)
- W x H x D (mm) 112 x 71.9 x 100
- Connection technology (system/field supply): CAGE CLAMP®
- Conductor cross section: 0.08 ... 2.5 mm²/28 ... 14 AWG



### Housing design (E)

- SD card slot for external storage media (g)
- Start/stop switch (h)
- W x H x D (mm) 112 x 71.9 x 100
- Connection technology (system/field supply): CAGE CLAMP®
- Conductor cross section: 0.08 ... 2.5 mm²/28 ... 14 AWG



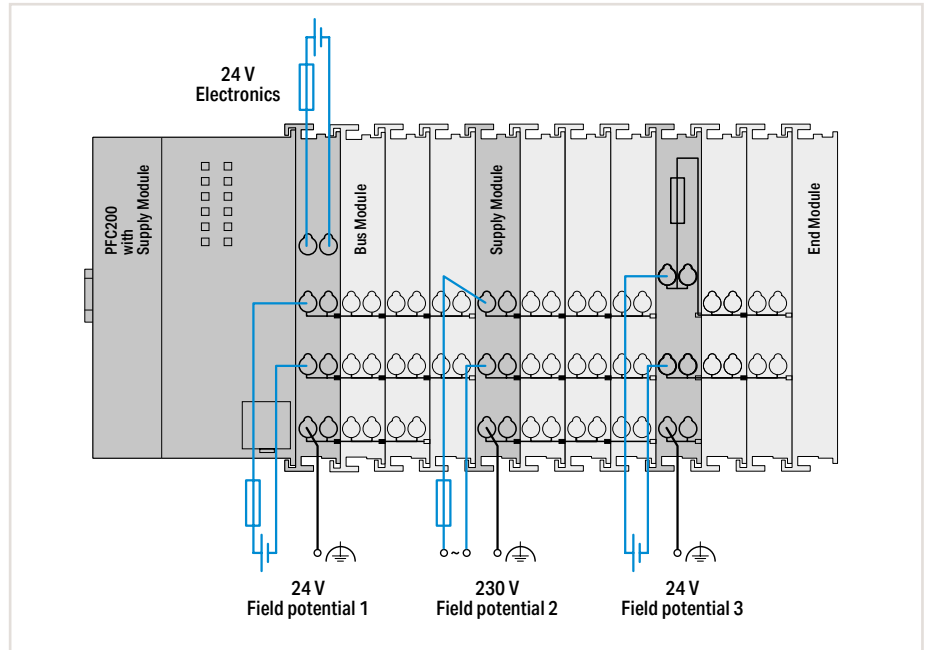
### Housing design (F)

- SD card slot for external storage media (g)
- Start/stop switch (h)
- GSM antenna connection (k)
- SIM card slot (l)
- W x H x D (mm) 102.5 x 71.9 x 100
- Connection technology (system/field supply): CAGE CLAMP®
- Conductor cross section: 0.08 ... 2.5 mm²/28 ... 14 AWG

## Controllers PFC100/PFC200 Installation Instructions

### Power Supply

The internal electronics are powered by the controller. The power supply to the field-side supply is electrically isolated. The division enables a separate supply for sensors and actuators. Snapping the I/O modules together automatically routes the supply voltages. Supply modules with diagnostics enable additional monitoring of the power supply. This configuration ensures a flexible, user-specific supply design for a station. The current supply to the electronics is limited by a maximum value. If the sum of the internal current demand of all the I/O modules should exceed this value, an additional system supply module is necessary. Even in this case, power supply to the field-side supply of 10 A may not be exceeded. However, different power supply modules allow a new power supply, formation of potential groups and the implementation of emergency stops.



### Notes

Additional steps must be implemented based on where the I/O system is installed:

Specific power and field-side power supply filters (750-624 or 750-626) are required for marine and onshore/offshore applications. A specific supply module (750-606) is required to operate intrinsically safe Ex i modules.

Additionally, both a supply module and a field-side power supply filter are recommended when operating intrinsically safe Ex i modules for marine and onshore/offshore applications.

As part of operating safety-related I/O modules, PELV/SELV power supply units must be used for 24 VDC supply of electronics and field. In addition, specific power and field-side power supply filters must be provided (750-626).

Please refer to the manual for details about the power supply's design.

### Item Number Key

Explanation of the components of an item number key

#### Item No.: 750-81xx = PFC100

- 00: 2 x ETHERNET, Eco
- 01: 2 x ETHERNET
- 02: 2 x ETHERNET, RS-232/-485

#### Item No.: 750-82xy = PFC200

- 0y: Generation 1
- 1y: Generation 2
  - x2: 2 x ETHERNET, RS-232/-485
  - x3: 2 x ETHERNET, CAN
  - x4: 2 x ETHERNET, RS-232/-485, CAN
  - x5: 4 x ETHERNET, CAN, CANopen, USB
  - x6: 2 x ETHERNET, RS-232/-485, CAN, PROFIBUS-DP slave
  - x7: 2 x ETHERNET, RS-232/-485, mobile radio module
  - x8: 2 x ETHERNET, RS-232/-485, CAN, CANopen, PROFIBUS master

.../025-yyy: Extended temperature range of -20 ... +60 °C

- 000: Standard
- 001: Telecontrol technology
- 002: Telecontrol Eco

## Controllers PFC100/PFC200

### Standards and Rated Conditions

General Specifications	
Supply voltage (system)	24 VDC (-25 ... +30 %)*; *for all marine-certified controllers
Isolation	500 V (system/supply)
Surrounding air temperature (operation)	0 ... +55 °C
Surrounding air temperature (operation) for versions with an extended temperature range	-20 ... +60 °C
Surrounding air temperature (storage)	-40 ... +85 °C
Relative humidity	95 % (non condensing)
Relative humidity for versions with an extended temperature range	Max. 95 %, short-term condensation per Class 3K6 / IEC EN 60721-3-3 and E DIN 40046-721-3, taking a temperature range of -20 ... +60 °C into consideration (except wind-driven precipitation, water and ice formation)
Operating altitude	0 ... 2000 m
Pollution degree	2 per IEC 61131-2
Vibration resistance	0.5g (4g for all marine-certified controllers) per IEC 60068-2-6
Shock resistance	15g per IEC 60068-2-27
EMC immunity to interference	Per EN 61000-6-2
EMC emission of interference	Per EN 61000-6-3
Protection type	IP20
Mounting type	DIN-35 rail
Housing material	Polycarbonate; polyamid 6.6
Exposure to pollutants	Per IEC 60068-2-42 and IEC 60068-2-43
Permissible SO <sub>2</sub> contaminant concentration at a relative humidity < 75 %	25 ppm
Permissible H <sub>2</sub> S contaminant concentration at a relative humidity < 75 %	10 ppm
Connection technology	CAGE CLAMP®
Conductor cross sections; strip length Standard PFC100/200	0.08 ... 2.5 mm <sup>2</sup> /28 ... 14 AWG; 8 ... 9 mm / 0.31 ... 0.35 inch
Conductor cross sections; strip length PFC100 Eco	0.08 ... 1.5 mm <sup>2</sup> /28 ... 16 AWG; 5 ... 6 mm / 0.2 ... 0.24 inch
Current carrying capacity (power jumper contacts)	10 A

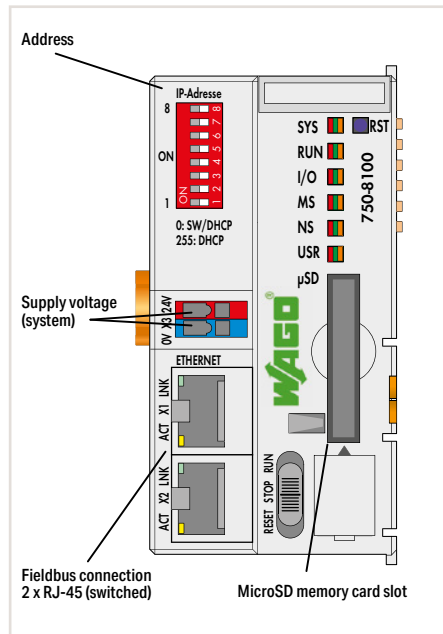
4.1

## Approvals

Overview of the approvals in the article comparison in Section 11, Technical Appendix, or online at [www.wago.com](http://www.wago.com)



## Controller PFC100; 2 x ETHERNET; Eco



4.1

<b>Item description</b>	<b>Controller PFC100; 2 x ETHERNET; Eco</b>				
<b>Version</b>	<b>Default</b>				
<b>Item No.</b>	<b>750-8100</b>				
<b>Order text</b>	<b>PFC100; 2ETH; Eco</b>				
<b>Technical Data</b>					
Communication	Modbus (TCP, UDP); EtherNet/IP adapter (slave) <sup>1)</sup> ; MQTT				
ETHERNET protocols	DHCP; DNS; NTP; FTP; FTPS; SNMP; HTTP; HTTPS; SSH				
Visualization	Web-Visu				
Programming	e!COCKPIT (based on CODESYS V3)				
CPU	Cortex A8; 600 MHz				
Operating system	Real-time Linux (with RT-Preempt patch)				
Non-volatile memory (hardware)	64 KB				
Program memory/data memory/non-volatile memory (software)	10 MB* / 10 MB* / 64 KB				
Number of modules per node (max.)	250				
Input and output process image (internal) max.	1000 words				
Input and output process image (MODBUS) max.	32000 words				
Supply voltage (system)	24 VDC (-25 ... +30 %), via wiring level				
Input current (typ.) at nominal load (24 V)	300 mA				
Total current (system supply)	700 mA				
Surrounding air temperature (operation)	0 ... +55 °C				
Dimensions W x H x D	49.5 x 71.9 x 96.8 mm				
<b>Approvals</b>	CE; Marine; OrdLoc/HazLoc; ATEX/IECEX				
<b>Data sheet and further information, see:</b>	<a href="http://wago.com/750-8100">wago.com/750-8100</a>				
<b>Accessories</b>					
microSD memory card; 2 GB	<table border="1"> <thead> <tr> <th>Item No.</th> <th>Page</th> </tr> </thead> <tbody> <tr> <td>758-879/000-3102</td> <td>470</td> </tr> </tbody> </table>	Item No.	Page	758-879/000-3102	470
Item No.	Page				
758-879/000-3102	470				

<sup>1)</sup>Library for e!RUNTIME

\*For memory configuration via e!RUNTIME, the program and data memory together have a maximum size of 10 MB and can be distributed dynamically.

„ Software e!COCKPIT, WAGO-I/O-PRO V2.3, see Section 2, page 26 and 32

„ Mini-WSB marker card and mounting accessories, see Section "Accessories and Tools"

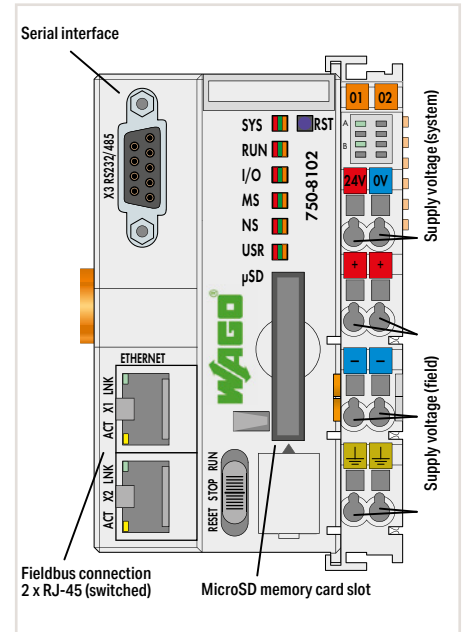
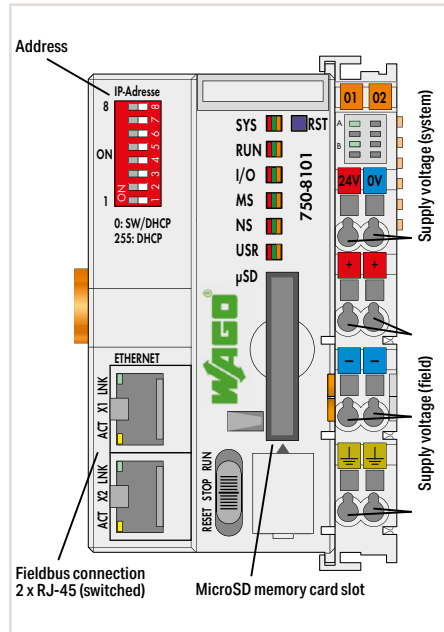
„ Approvals and corresponding ratings, see page 516 or [www.wago.com](http://www.wago.com)



# Controller PFC100; 2 x ETHERNET or 2 x ETHERNET; RS-232/-485



Figure: 750-8102



<b>Item description</b>
<b>Version</b>
<b>Item No.</b>
<b>Order text</b>

<b>Controller PFC100; 2 x ETHERNET</b>	
<b>Default</b>	<b>Ext. temperature</b>
750-8101	750-8101/025-000
PFC100; 2ETH	PFC100; 2ETH; T

<b>PFC100 Controller; 2 x ETHERNET; RS-232/-485</b>	
<b>Default</b>	<b>Ext. temperature</b>
750-8102	750-8102/025-000
PFC100; 2ETH RS	PFC100; 2ETH RS; T

**Technical Data**

Communication
ETHERNET protocols
Visualization
Programming
CPU
Operating system
Non-volatile memory (hardware)
Program memory/data memory/non-volatile memory (software)
Number of modules per node (max.)
Input and output process image (internal) max.
Input and output process image (MODBUS) max.
Supply voltage (system)
Supply voltage (field)
Input current (typ.) at nominal load (24 V)
Total current (system supply)
Surrounding air temperature (operation)
Dimensions W x H x D
Approvals
Data sheet and further information, see:
<b>Accessories</b>
microSD memory card; 2 GB

Modbus (TCP, UDP); EtherNet/IP adapter (slave) <sup>1)</sup> ; MQTT	
DHCP; DNS; NTP; FTP; FTPS; SNMP; HTTP; HTTPS; SSH	
Web-Visu	
e!COCKPIT (based on CODESYS V3)	
Cortex A8; 600 MHz	
Real-time Linux 3.18 (with RT-Preempt patch)	
64 KB	
12 MB* / 12 MB* / 64 KB	
250	
1000 words	
32000 words	
24 VDC (-25 ... 30 %); via wiring level (CAGE CLAMP® connection)	
24 VDC (-25 ... +30 %); via power jumper contacts	
550 mA	
1700 mA	
0 ... +55 °C	
-20 ... +60 °C	
61.5 x 71.9 x 100 mm	
CE; Marine; OrdLoc/HazLoc; ATEX/IECEx	
wago.com/750-8101	
<b>Item No.</b>	<b>Page</b>
758-879/000-3102	470

Modbus (TCP, UDP, RTU); EtherNet/IP adapter (slave) <sup>1)</sup> ; MQTT; RS-232/-485 interface	
DHCP; DNS; NTP; FTP; FTPS; SNMP; HTTP; HTTPS; SSH	
Web-Visu	
e!COCKPIT (based on CODESYS V3)	
Cortex A8; 600 MHz	
Real-time Linux 3.18 (with RT-Preempt patch)	
128 KB	
12 MB* / 12 MB* / 128 KB	
250	
1000 words	
32000 words	
24 VDC (-25 ... 30 %); via wiring level (CAGE CLAMP® connection)	
24 VDC (-25 ... +30 %); via power jumper contacts	
550 mA	
1700 mA	
0 ... +55 °C	
-20 ... +60 °C	
61.5 x 71.9 x 100 mm	
CE; Marine; OrdLoc/HazLoc; ATEX/IECEx	
wago.com/750-8102	
<b>Item No.</b>	<b>Page</b>
758-879/000-3102	470

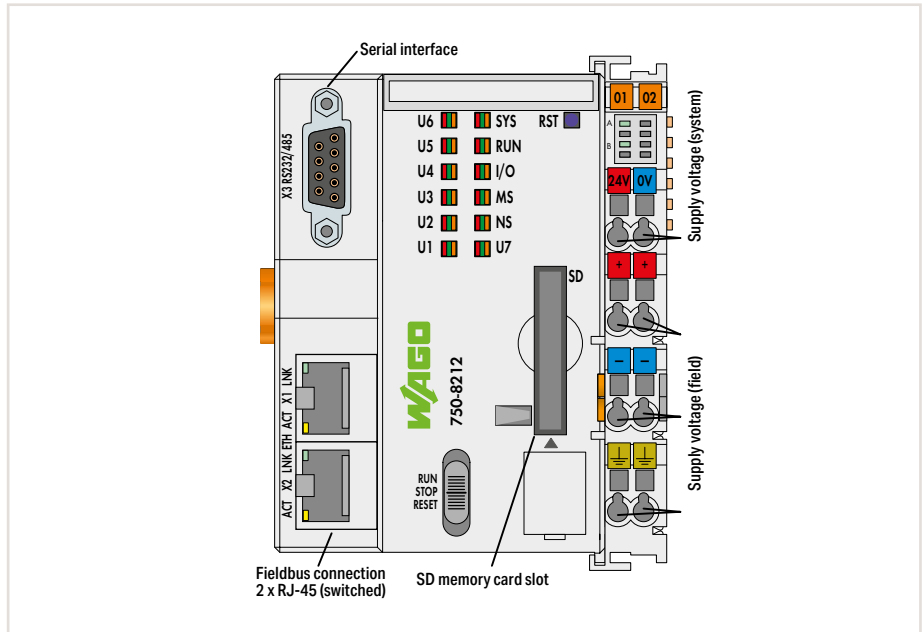
<sup>1)</sup>Library for e!RUNTIME  
 \*For memory configuration via e!RUNTIME, the program and data memory together have a maximum size of 12 MB and can be distributed dynamically.

<sup>1)</sup>Library for e!RUNTIME  
 \*For memory configuration via e!RUNTIME, the program and data memory together have a maximum size of 12 MB and can be distributed dynamically.

# Controller PFC200; 2nd Generation; 2 x ETHERNET, RS-232/-485



Figure: 750-8212



4.1

Item description		Controller PFC200; 2nd generation; 2 x ETHERNET, RS-232/-485			
Version		Default	Ext. temperature	Telecontrol technology; ext. temperature	Telecontrol technology; ext. temperature; Eco
Item No.		750-8212	750-8212/025-000	750-8212/025-001	750-8212/025-002
Order text		PFC200; G2; 2ETH RS	PFC200; G2; 2ETH RS; T	PFC200; G2; 2ETH RS; Tele; T	PFC200; G2; 2ETH RS; Tele; T; Eco
Technical Data					
Communication		Modbus (TCP, UDP, RTU); EtherNet/IP adapter (slave)1); MQTT; RS-232/-485 interface; EtherCAT-Master <sup>2)</sup>		Modbus (TCP, UDP, RTU); MQTT; Telecontrol protocols; RS-232/-485 interface	
ETHERNET protocols		DHCP; DNS; NTP; FTP; FTPS; SNMP; HTTP; HTTPS; SSH			
Telecontrol protocols		IEC 60870-5-101/-103/-104; IEC 61850-7-4; IEC 61400-25; DNP3			
Visualization		Web-Visu			
Programming		WAGO-I/O-PRO V2.3 (based on CODESYS V2.3); e!COCKPIT (based on CODESYS V3)		WAGO-I/O-PRO V2.3 (based on CODESYS V2.3)	
CPU		Cortex A8; 1 GHz			
Operating system		Real-time Linux (with RT-Preempt patch)			
Main memory (RAM)/internal memory (flash)/non-volatile memory (hardware)		512 MB / 4 GB / 128 KB			
Program memory/data memory/non-volatile memory (software)		CODESYS V2: 16 MB / 64 MB / 128 KB		e!RUNTIME: 60 MB* / 60 MB* / 128 KB	
Number of modules per node (max.)		250		4	
Input and output process image (internal) max.		1000 words			
Input and output process image (MODBUS) max.		CODESYS V2: 1000 words		e!RUNTIME: 32000 words	
Supply voltage (system)		24 VDC (-25 ... 30 %); via wiring level (CAGE CLAMP® connection)			
Supply voltage (field)		24 VDC (-25 ... +30 %); via power jumper contacts			
Input current (typ.) at nominal load (24 V)		550 mA			
Total current (system supply)		1700 mA			
Surrounding air temperature (operation)		0 ... +55 °C		-20 ... +60 °C	
Dimensions W x H x D		78.6 x 71.9 x 100 mm			
Approvals		CE; Marine; OrdLoc**/HazLoc; ATEX/IECEx			
Data sheet and further information, see:		<a href="http://wago.com/750-8212">wago.com/750-8212</a>			
Accessories		Item No.	Page		
SD memory card; 2 GB		758-879/000-001	470		
e!RUNTIME; EtherCAT Master 300; Single license		2759-263/210-1000	45		

<sup>1)</sup> Software e!COCKPIT, WAGO-I/O-PRO V2.3, see Section 2, page 26 and 32

<sup>2)</sup> Approvals and corresponding ratings, see page 516 or [www.wago.com](http://www.wago.com)

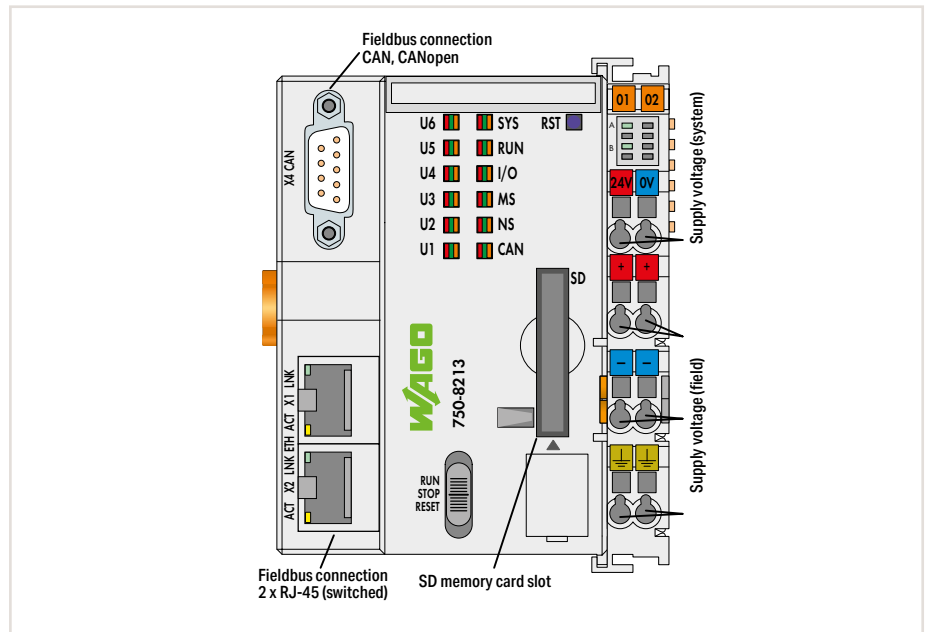
<sup>1)</sup>Library for e!RUNTIME

<sup>2)</sup>for e!RUNTIME; requires an additional license

\*For memory configuration via e!RUNTIME, the program and data memory together have a maximum size of 60 MB and can be distributed dynamically.

\*\*Pending

## Controller PFC200; 2nd Generation; 2 x ETHERNET, CAN, CANopen



<b>Item description</b>	Controller PFC200; 2nd generation; 2 x ETHERNET, CAN, CANopen	
<b>Version</b>	Default	
<b>Item No.</b>	750-8213	
<b>Order text</b>	PFC200; G2; 2ETH CAN	
<b>Technical Data</b>		
Communication	Modbus (TCP, UDP); EtherNet/IP adapter (slave) <sup>1)</sup> ; MQTT; CANopen; EtherCAT Master <sup>2)</sup>	
ETHERNET protocols	DHCP; DNS; NTP; FTP; FTPS; SNMP; HTTP; HTTPS; SSH	
Visualization	Web-Visu	
Programming	WAGO-I/O-PRO V2.3 (based on CODESYS V2.3); e!COCKPIT (based on CODESYS V3)	
CPU	Cortex A8; 1 GHz	
Operating system	Real-time Linux (with RT-Preempt patch)	
Main memory (RAM)/internal memory (flash)/non-volatile memory (hardware)	512 MB / 4 GB / 128 KB	
Program memory/data memory/non-volatile memory (software)	CODESYS V2:	16 MB / 64 MB / 128 KB
	e!RUNTIME:	60 MB* / 60 MB* / 128 KB
Number of modules per node (max.)	250	
Input and output process image (internal) max.	1000 words	
Input and output process image (MODBUS)/(CAN) max.	CODESYS V2:	1000 words / 2000 words
	e!RUNTIME:	32000 words / 2000 words
Supply voltage (system)	24 VDC (-25 ... 30 %); via wiring level (CAGE CLAMP® connection)	
Supply voltage (field)	24 VDC (-25 ... +30 %); via power jumper contacts	
Input current (typ.) at nominal load (24 V)	550 mA	
Total current (system supply)	1700 mA	
Surrounding air temperature (operation)	0 ... +55 °C	
Dimensions W x H x D	78.6 x 71.9 x 100 mm	
<b>Approvals</b>	CE; Marine; OrdLoc**/HazLoc; ATEX/IECEX	
<b>Data sheet and further information, see:</b>	wago.com/750-8213	
<b>Accessories</b>	<b>Item No.</b>	<b>Page</b>
SD memory card; 2 GB	758-879/000-001	470
e!RUNTIME; EtherCAT Master 300; Single license	2759-263/210-1000	45

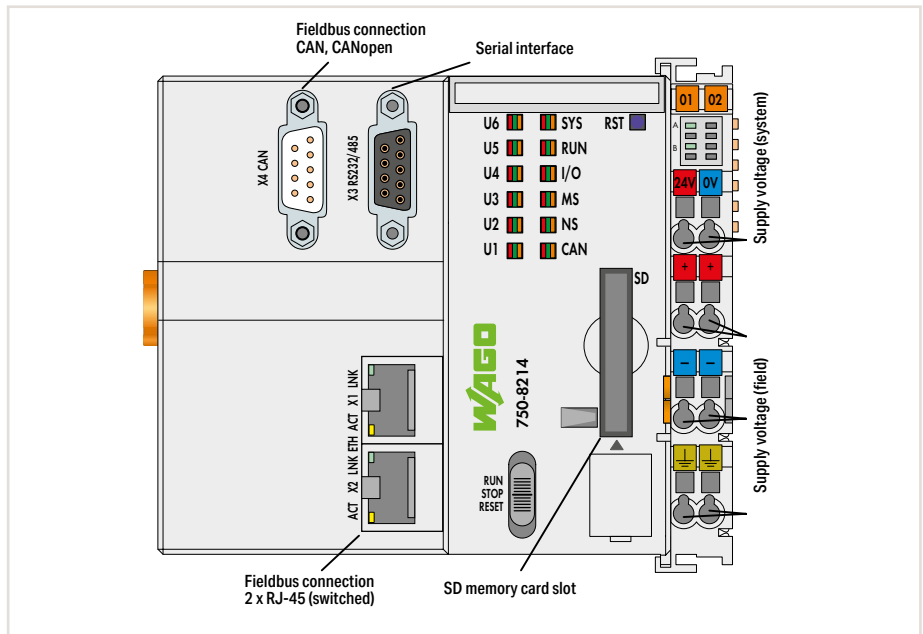
<sup>1)</sup>Library for e!RUNTIME

<sup>2)</sup>for e!RUNTIME; requires an additional license

\*For memory configuration via e!RUNTIME, the program and data memory together have a maximum size of 60 MB and can be distributed dynamically.

\*\*Pending

# Controller PFC200; 2nd Generation; 2 x ETHERNET, RS-232/-485, CAN, CANopen



## 4.1

<b>Item description</b>	Controller PFC200; 2nd generation; 2 x ETHERNET, RS-232/-485, CAN, CANopen	
<b>Version</b>	Default	
<b>Item No.</b>	750-8214	
<b>Order text</b>	PFC200; G2; 2ETH RS CAN	
<b>Technical Data</b>		
Communication	Modbus (TCP, UDP, RTU); EtherNet/IP adapter (slave)1); MQTT; CANopen; RS-232/-485 interface; EtherCAT Master <sup>2)</sup>	
ETHERNET protocols	DHCP; DNS; NTP; FTP; HTTPS; SNMP; HTTP; HTTPS; SSH	
Visualization	Web-Visu	
Programming	WAGO-I/O-PRO V2.3 (based on CODESYS V2.3); e!COCKPIT (based on CODESYS V3)	
CPU	Cortex A8; 1 GHz	
Operating system	Real-time Linux (with RT-Preempt patch)	
Main memory (RAM)/internal memory (flash)/non-volatile memory (hardware)	512 MB / 4 GB / 128 KB	
Program memory/data memory/non-volatile memory (software)	CODESYS V2:	16 MB / 64 MB / 128 KB
	e!RUNTIME:	60 MB* / 60 MB* / 128 KB
Number of modules per node (max.)	250	
Input and output process image (internal) max.	1000 words	
Input and output process image (MODBUS)/(CAN) max.	CODESYS V2:	1000 words / 2000 words
	e!RUNTIME:	32000 words / 2000 words
Supply voltage (system)	24 VDC (-25 ... 30 %); via wiring level (CAGE CLAMP® connection)	
Supply voltage (field)	24 VDC (-25 ... +30 %); via power jumper contacts	
Input current (typ.) at nominal load (24 V)	550 mA	
Total current (system supply)	1700 mA	
Surrounding air temperature (operation)	0 ... +55 °C	
Dimensions W x H x D	78.6 x 71.9 x 100 mm	
<b>Approvals</b>	CE; Marine; OrdLoc**/HazLoc; ATEX/IECEX	
<b>Data sheet and further information, see:</b>	<a href="http://wago.com/750-8214">wago.com/750-8214</a>	
<b>Accessories</b>	<b>Item No.</b>	<b>Page</b>
SD memory card; 2 GB	758-879/000-001	470
e!RUNTIME; EtherCAT Master 300; Single license	2759-263/210-1000	45

<sup>1)</sup>Library for e!RUNTIME

<sup>2)</sup>for e!RUNTIME; requires an additional license

\*For memory configuration via e!RUNTIME, the program and data memory together have a maximum size of 60 MB and can be distributed dynamically.

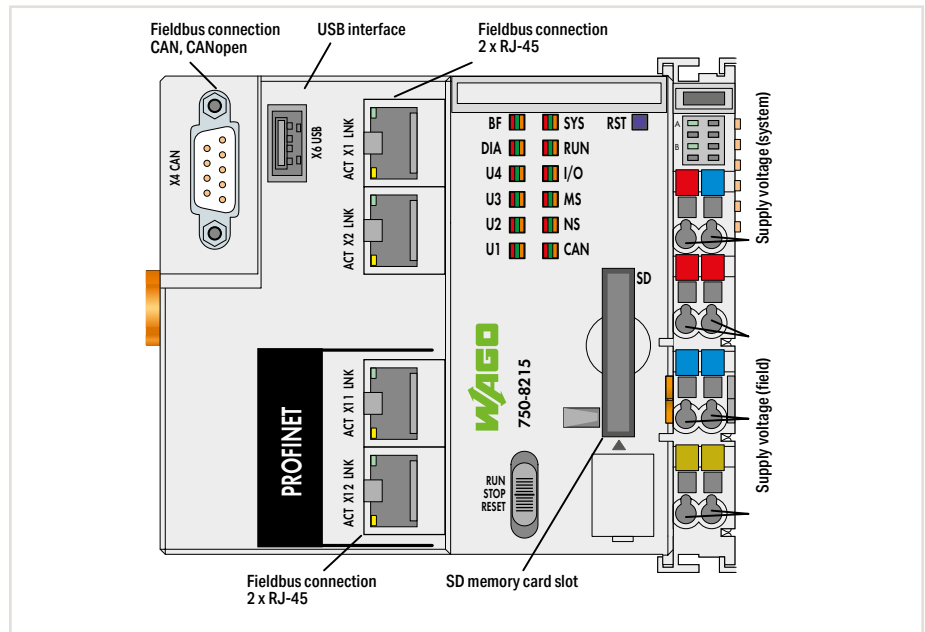
\*\*Pending

„ Software e!COCKPIT, WAGO-I/O-PRO V2.3, see Section 2, page 26 and 32

„ Mini-WSB marker card and mounting accessories, see Section "Accessories and Tools"

„ Approvals and corresponding ratings, see page 516 or [www.wago.com](http://www.wago.com)

## Controller PFC200; 2nd Generation; 4 x ETHERNET, CAN, CANopen, USB



<b>Item description</b>	<b>Controller PFC200; 2nd generation; 4 x ETHERNET, CAN, CANopen, USB</b>		<b>4.1</b>
<b>Version</b>	<b>Default</b>		
<b>Item No.</b>	<b>750-8215</b>		
<b>Order text</b>	<b>PFC200; G2; 4ETH CAN USB</b>		
<b>Technical Data</b>			
Communication	PROFINET RT (Slave); Modbus (TCP, UDP); CANopen, EtherNet/IP adapter (slave) <sup>1)</sup> ; MQTT; EtherCAT Master <sup>2)</sup>		
ETHERNET protocols	DHCP; DNS; NTP; FTP; FTPS; SNMP; HTTP; HTTPS; SSH		
PROFINET IO features	PROFINET IO V2.3; Media redundancy (MRP); Shared device		
Visualization	Web-Visu		
Programming	e!COCKPIT (based on CODESYS V3)		
CPU	Cortex A8; 1 GHz		
Operating system	Real-time Linux (with RT-Preempt patch)		
Main memory (RAM)/internal memory (flash)/non-volatile memory (hardware)	512 MB / 4 GB / 128 KB		
Program memory/data memory/non-volatile memory (software)	16 MB* / 64 MB* / 128 KB		
Number of modules per node (max.)	250		
Input and output process image (internal) max.	1000 words		
Input and output process image (MODBUS)/(PROFINET)/(CAN) max.	1000 words / 1024 bytes** / 2000 words		
Supply voltage (system)	24 VDC (-25 ... 30 %); via wiring level (CAGE CLAMP® connection)		
Supply voltage (field)	24 VDC (-25 ... +30 %); via power jumper contacts		
Input current (typ.) at nominal load (24 V)	550 mA		
Total current (system supply)	1700 mA		
Surrounding air temperature (operation)	0 ... +55 °C		
Dimensions W x H x D	112 x 71.9 x 100 mm		
<b>Approvals</b>	CE; Marine***; OrdLoc***/HazLoc; ATEX/IECEx		
<b>Data sheet and further information, see:</b>	<a href="http://wago.com/750-8215">wago.com/750-8215</a>		
<b>Accessories</b>	<b>Item No.</b>	<b>Page</b>	
SD memory card; 2 GB	758-879/000-001	470	
e!RUNTIME; EtherCAT Master 300; Single license	2759-263/210-1000	45	

<sup>1)</sup>Library for e!RUNTIME

<sup>2)</sup>for e!RUNTIME; requires an additional license

\*For memory configuration via e!RUNTIME, the program and data memory together have a maximum size of 60 MB and can be distributed dynamically.

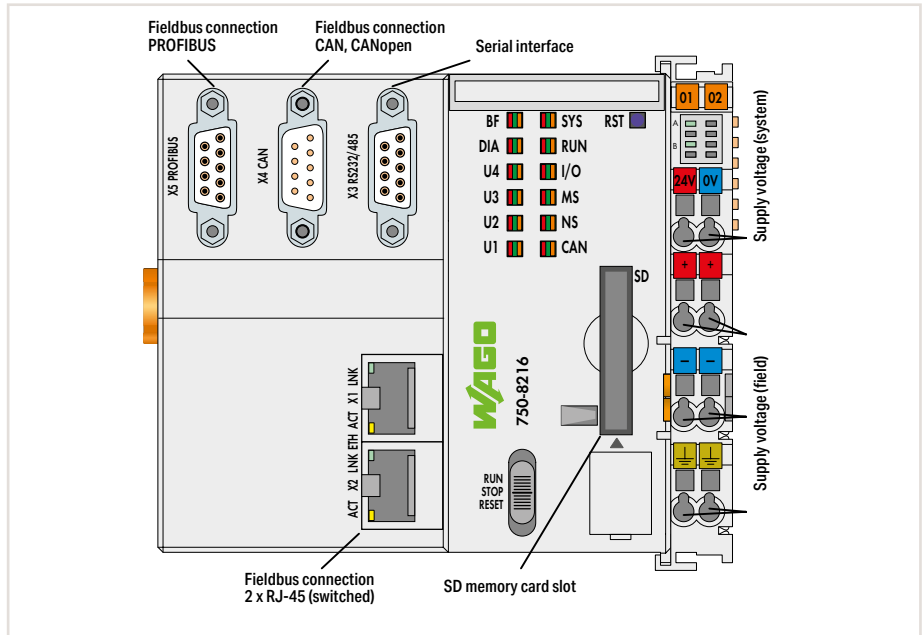
\*\*per application relation (AR)

\*\*\*Pending

# Controller PFC200; 2nd Generation; 2 x ETHERNET, RS-232/-485, CAN, CANopen, PROFIBUS Slave



Figure: 750-8216



4.1

Item description	Controller PFC200; 2nd generation; 2 x ETHERNET, RS-232/-485, CAN, CANopen, PROFIBUS Slave		
Version	Default	Ext. temperature	Telecontrol technology; ext. temperature
Item No.	750-8216	750-8216/025-000	750-8216/025-001
Order text	PFC200; G2; 2ETH RS CAN DPS	PFC200; G2; 2ETH RS CAN DPS; T	PFC200; G2; 2ETH RS CAN DPS; Tele; T
<b>Technical Data</b>			
Communication	Modbus (TCP, UDP, RTU); EtherNet/IP adapter (slave)1); MQTT; PROFIBUS; CANopen; RS-232/-485 interface; EtherCAT-Master <sup>2)</sup>		Modbus (TCP, UDP, RTU); MQTT; PROFIBUS; CANopen; Telecontrol protocols; RS-232/-485 interface
ETHERNET protocols	DHCP; DNS; NTP; FTP; FTPS; SNMP; HTTP; HTTPS; SSH		
Telecontrol protocols	IEC 60870-5-101/-103/-104; IEC 61850-7-4; IEC 61400-25; DNP3		
Visualization	Web-Visu		
Programming	WAGO-I/O-PRO V2.3 (based on CODESYS V2.3); e!COCKPIT (based on CODESYS V3)	WAGO-I/O-PRO V2.3 (based on CODESYS V2.3)	
CPU	Cortex A8; 1 GHz		
Operating system	Real-time Linux (with RT-Preempt patch)		
Main memory (RAM)/internal memory (flash)/non-volatile memory (hardware)	512 MB / 4 GB / 128 KB		
Program memory/data memory/non-volatile memory (software)	CODESYS V2: 16 MB / 64 MB / 128 KB	e!RUNTIME: 60 MB* / 60 MB* / 128 KB	
Number of modules per node (max.)	250		
Input and output process image (internal) max.	1000 words		
Input and output process image (MODBUS)/(PROFIBUS)/(CAN) max.	CODESYS V2: 1000 words / 244 bytes / 2000 words	e!RUNTIME: 32000 words / 244 bytes / 2000 words	
Supply voltage (system)	24 VDC (-25 ... 30 %); via wiring level (CAGE CLAMP® connection)		
Supply voltage (field)	24 VDC (-25 ... +30 %); via power jumper contacts		
Input current (typ.) at nominal load (24 V)	550 mA		
Total current (system supply)	1700 mA		
Surrounding air temperature (operation)	0 ... +55 °C	-20 ... +60 °C	
Dimensions W x H x D	112 x 71.9 x 100 mm		
Approvals	CE; Marine; OrdLoc**/HazLoc; ATEX/IECEx		
Data sheet and further information, see:	wago.com/750-8216		
<b>Accessories</b>	<b>Item No.</b>	<b>Page</b>	
SD memory card; 2 GB	758-879/000-001	470	
e!RUNTIME; EtherCAT Master 300; Single license	2759-263/210-1000	45	

<sup>1)</sup>Library for e!RUNTIME; <sup>2)</sup>for e!RUNTIME; requires an additional license

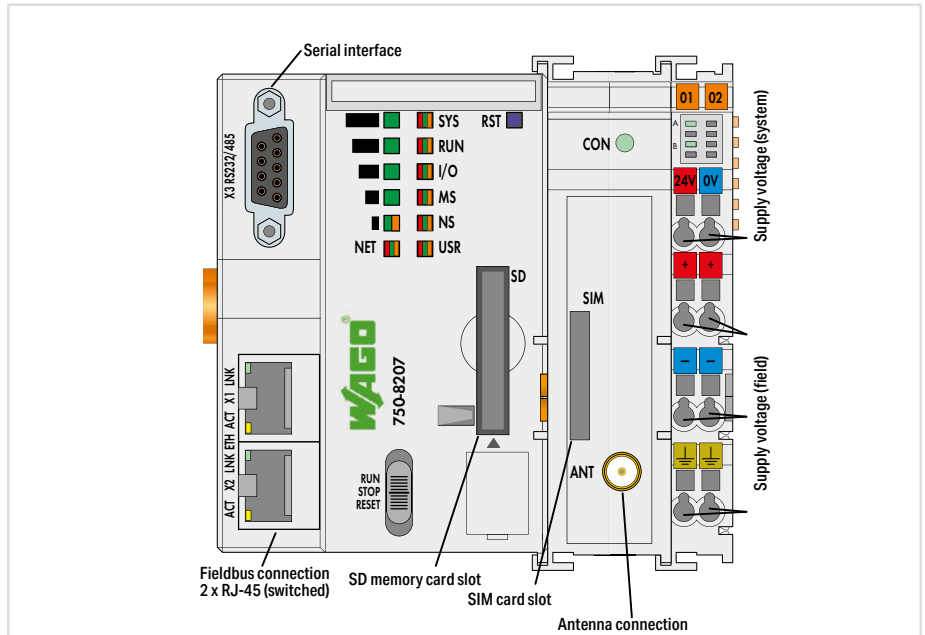
\*For memory configuration via e!RUNTIME, the program and data memory together have a maximum size of 60 MB and can be distributed dynamically.

\*\*Pending

# Controller PFC200; 2 x ETHERNET, RS-232/-485, Mobile Radio Module



Figure: 750-8207



<b>Item description</b>
<b>Version</b>
<b>Item No.</b>
<b>Order text</b>

<b>Controller PFC200; 2 x ETHERNET, RS-232/-485, Mobile radio module</b>		
<b>Default</b>	<b>Ext. temperature</b>	<b>Telecontrol technology; ext. temperature</b>
750-8207	750-8207/025-000	750-8207/025-001
PFC200; 2ETH RS 3G	PFC200; 2ETH RS 3G; T	PFC200; 2ETH RS 3G; Tele; T

4.1

<b>Technical Data</b>
Communication
ETHERNET protocols
Telecontrol protocols
Radio technology
Frequency band
Services
Security encryption
Visualization
Programming
CPU
Operating system
Main memory (RAM)/internal memory (flash)/non-volatile memory (hardware)
Program memory/data memory/non-volatile memory (software)
Number of modules per node (max.)
Input and output process image (internal) max.
Input and output process image (MODBUS) max.
Supply voltage (system)
Supply voltage (field)
Input current (typ.) at nominal load (24 V)
Total current (system supply)
Surrounding air temperature (operation)
Dimensions W x H x D
<b>Approvals</b>
<b>Data sheet and further information, see:</b>

Modbus (TCP, UDP, RTU); EtherNet/IP adapter (slave) <sup>1)</sup> ; MQTT; RS-232/-485 interface	Modbus (TCP, UDP, RTU); MQTT; Telecontrol protocols; RS-232/-485 interface
DHCP; DNS; NTP; FTP; FTPS; SNMP; HTTP; HTTPS; SSH	
GSM/Edge/UMTS/HSPA+	
GSM quad-band	
SMS (bidirectional); GPRS connection to Internet	
OpenVPN; IPsec; firewall	
Web-Visu	
WAGO-I/O-PRO V2.3 (based on CODESYS V2.3); e!COCKPIT (based on CODESYS V3)	WAGO-I/O-PRO V2.3 (based on CODESYS V2.3)
Cortex A8; 600 MHz	
Real-time Linux (with RT-Preempt patch)	
256 MB / 256 MB / 128 KB	
CODESYS V2:	16 MB / 64 MB / 128 KB
e!RUNTIME:	60 MB* / 60 MB* / 128 KB
250	
1000 words	
CODESYS V2:	1000 words
e!RUNTIME:	32000 words
24 VDC (-25 ... 30 %); via wiring level (CAGE CLAMP® connection)	
24 VDC (-25 ... +30 %); via power jumper contacts	
550 mA	
700 mA	
0 ... +55 °C	-20 ... +60 °C
102.5 x 71.9 x 100 mm	
CE; OrdLoc**	
<a href="http://wago.com/750-8207">wago.com/750-8207</a>	

<b>Accessories</b>
SD memory card; 2 GB
Antenna, GSM

<b>Item No.</b>	<b>Page</b>
758-879/000-001	470
758-965	471

<sup>1)</sup>Library for e!RUNTIME; \*For memory configuration via e!RUNTIME, the program and data memory together have a maximum size of 60 MB and can be distributed dynamically.  
 \*\*Pending

# Controller PFC200; 2 x ETHERNET, RS-232/-485, CAN, CANopen, PROFIBUS Master

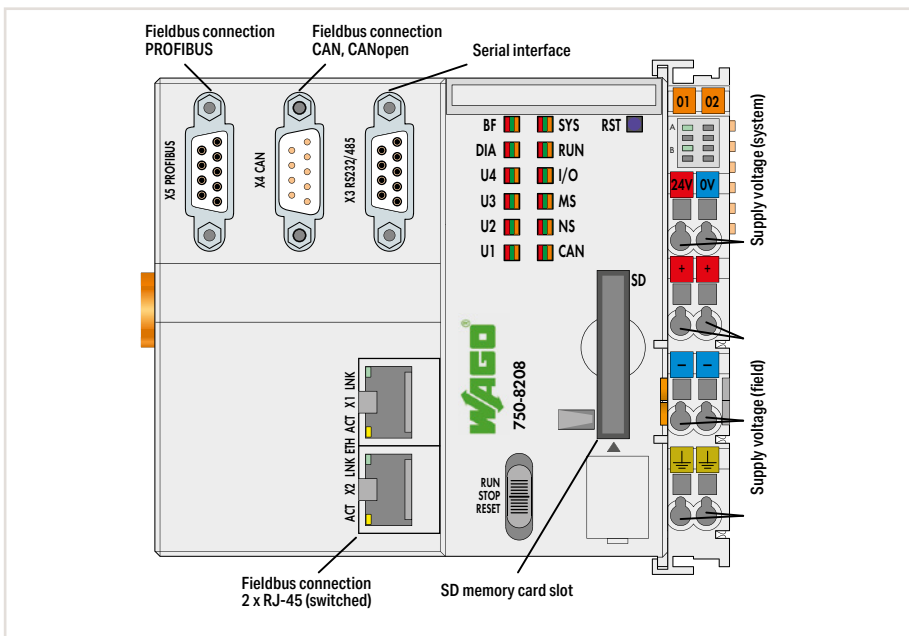


Figure: 750-8208

4.1

<b>Item description</b>	<b>Controller PFC200; 2 x ETHERNET, RS-232/-485, CAN, CANopen, PROFIBUS Master</b>		
<b>Version</b>	<b>Default</b>	<b>Ext. temperature</b>	<b>Telecontrol technology; ext. temperature</b>
<b>Item No.</b>	750-8208	750-8208/025-000	750-8208/025-001
<b>Order text</b>	PFC200; 2ETH RS CAN DPM	PFC200; 2ETH RS CAN DPM; T	PFC200; 2ETH RS CAN DPM; Tele; T

Technical Data	
Communication	PROFIBUS DP Master; CAN; CANopen; Modbus (TCP, UDP, RTU); MQTT; RS-232/-485 interface
ETHERNET protocols	DHCP; DNS; NTP; FTP; HTTPS; SNMP; HTTP; HTTPS; SSH
Telecontrol protocols	PROFIBUS DP Master; CAN; CANopen; Modbus (TCP, UDP, RTU); MQTT; Telecontrol protocols; RS-232/-485 interface
Visualization	Web-Visu
Programming	WAGO-I/O-PRO V2.3 (based on CODESYS V2.3)
CPU	Cortex A8; 600 MHz
Operating system	Real-time Linux (with RT-Preempt patch)
Main memory (RAM)/internal memory (flash)/non-volatile memory (hardware)	256 MB / 256 MB / 128 KB
Program memory/data memory/non-volatile memory (software)	16 MB / 64 MB / 128 KB
Number of modules per node (max.)	250
Input and output process image (internal) max.	1000 words
Input and output process image (MODBUS)/(PROFIBUS)/(CAN) max.	1000 words / 5000 bytes* / 2000 words
Supply voltage (system)	24 VDC (-25 ... 30 %); via wiring level (CAGE CLAMP® connection)
Supply voltage (field)	24 VDC (-25 ... +30 %); via power jumper contacts
Input current (typ.) at nominal load (24 V)	550 mA
Total current (system supply)	1700 mA
Surrounding air temperature (operation)	0 ... +55 °C
Dimensions W x H x D (mm)	-20 ... +60 °C
Approvals	112 x 71.9 x 100 mm
Data sheet and further information, see:	CE; Marine; OrdLoc**; ATEX/IECEX wago.com/750-8208

Accessories	Item No.	Page
SD memory card; 2 GB	758-879/000-001	470

\*Input and output process image (PROFIBUS) max.: 5000 bytes (a maximum 125 slaves are supported, because a slave's process image can have up to 244 bytes/244 bytes)  
 \*\*Pending

„ Software WAGO-I/O-PRO V2.3, see Section 2, page 32  
 „ Mini-WSB marker card and mounting accessories, see Section "Accessories and Tools"  
 „ Approvals and corresponding ratings, see page 516 or www.wago.com



4.1

## WAGO Application Controllers

Machine Data Collection with MTConnect		Item No.
Application Controllers	Controller PFC100; FG0; 2 x ETHERNET	750-8101/000-010
Software	digitalTAP™ Application Software	Download: <a href="http://wago.com/applicationcontroller">wago.com/applicationcontroller</a>
Room Management with flexROOM®		
Application Controllers	Controller PFC200; FG1; 2 x ETHERNET; RS-232/-485	750-8202/000-011
Software	flexROOM® Application Software	Download: <a href="http://wago.com/applicationcontroller">wago.com/applicationcontroller</a>
Lighting Management		
Application Controllers	Controller PFC200; FG2; 2 x ETHERNET; RS-232/-485	750-8202/000-012
Software	Lighting Management	Download: <a href="http://wago.com/applicationcontroller">wago.com/applicationcontroller</a>
Energy Data Management		
Application Controllers	Controller PFC200; Energy data management application; 2 x ETHERNET; RS-232/-485	750-8202/000-022
	Controller PFC200; Energy data management application; 2 x ETHERNET; RS-232/-485; Mobile radio module	750-8207/000-022
Software	Energy Data Management	Download: <a href="http://wago.com/applicationcontroller">wago.com/applicationcontroller</a>

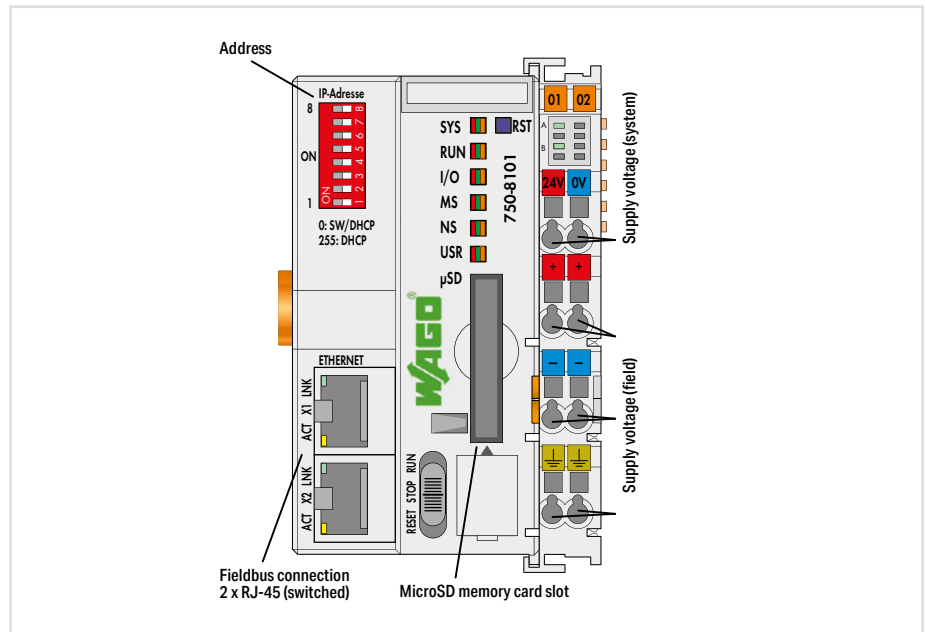
### 4.1

Application controllers are designed for special solutions and must be paired appropriately. You will find the appropriate solutions in Section 1.

## Controller PFC100; FG0; 2 x ETHERNET



Figure: 750-8101



Item description	Controller PFC100; FG0; 2 x ETHERNET	
Item No.	750-8101/000-010	
Order text	PFC100; FG0; 2ETH	
<b>Technical Data</b>		
Communication	Modbus (TCP, UDP); EtherNet/IP adapter (slave) <sup>1)</sup>	
ETHERNET protocols	DHCP; DNS; NTP; FTP; FTPS; SNMP; HTTP; HTTPS; SSH	
Visualization	Web-Visu	
Programming	e!COCKPIT (based on CODESYS V3)	
CPU	Cortex A8; 600 MHz	
Operating system	Real-time Linux 3.18 (with RT-Preempt patch)	
Non-volatile memory (hardware)	64 KB	
Program memory/data memory/non-volatile memory (software)	12 MB* / 12 MB* / 64 KB	
Number of modules per node (max.)	250	
Input and output process image (internal) max.	1000 words	
Input and output process image (MODBUS) max.	32000 words	
Supply voltage (system)	24 VDC (-25 ... 30 %); via wiring level (CAGE CLAMP® connection)	
Supply voltage (field)	24 VDC (-25 ... +30 %); via power jumper contacts	
Input current (typ.) at nominal load (24 V)	550 mA	
Total current (system supply)	1700 mA	
Surrounding air temperature (operation)	0 ... +55 °C	
Dimensions W x H x D	61.5 x 71.9 x 100 mm	
Approvals	CE; Marine; OrdLoc/HazLoc; ATEX/IECEx	
Data sheet and further information, see:	wago.com/750-8101/000-010	
<b>Accessories</b>		
microSD memory card; 2 GB	Item No.	Page
	758-879/000-3102	470

<sup>1)</sup>Library for e!RUNTIME

\*For memory configuration via e!RUNTIME, the program and data memory together have a maximum size of 12 MB and can be distributed dynamically.

Suitable software application:

- Machine Data Collection with MTConnect  
see Section 1

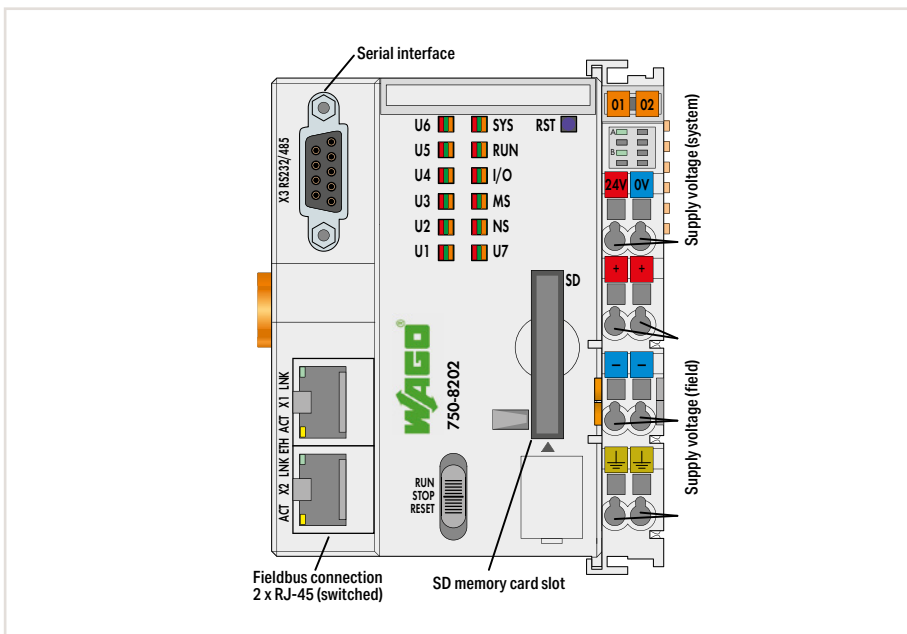
„ e!COCKPIT Software,  
see Section 2, page 26

„ Mini-WSB marker card and mounting accessories,  
see Section “Accessories and Tools”

# Controller PFC200; FG1; 2 x ETHERNET; RS-232/-485



Figure: 750-8202



4.1

<b>Item description</b>	<b>Controller PFC200; FG1; 2 x ETHERNET; RS-232/-485</b>	
<b>Item No.</b>	750-8202/000-011	
<b>Order text</b>	PFC200; FG1; 2ETH RS	
<b>Technical Data</b>		
Communication	Modbus (TCP, UDP, RTU); EtherNet/IP adapter (slave) <sup>1)</sup> ; RS-232/-485 interface	
ETHERNET protocols	DHCP; DNS; NTP; FTP; HTTPS; SNMP; HTTP; HTTPS; SSH	
Visualization	Web-Visu	
Programming	WAGO-I/O-PRO V2.3 (based on CODESYS V2.3), e!COCKPIT (based on CODESYS V3)	
CPU	Cortex A8; 600 MHz	
Operating system	Real-time Linux (with RT-Preempt patch)	
Main memory (RAM)/internal memory (flash)/non-volatile memory (hardware)	256 MB / 256 MB / 128 KB	
Program memory/data memory/non-volatile memory (software)	CODESYS V2:	16 MB / 64 MB / 128 KB
	e!RUNTIME:	60 MB* / 60 MB* / 128 KB
Number of I/O modules per node (max.)	250	
Input and output process image (internal) max.	1000 words	
Input and output process image (MODBUS) max.	CODESYS V2:	1000 words
	e!RUNTIME:	32000 words
Supply voltage (system)	24 VDC (-25 ... 30 %); via wiring level (CAGE CLAMP® connection)	
Supply voltage (field)	24 VDC (-25 ... +30 %); via power jumper contacts	
Input current (typ.) at nominal load (24 V)	550 mA	
Total current (system supply)	1700 mA	
Surrounding air temperature (operation)	0 ... +55 °C	
Dimensions W x H x D	78.6 x 71.9 x 100 mm	
<b>Approvals</b>	CE; Marine; OrdLoc/HazLoc; ATEX/IECEX	
<b>Data sheet and further information, see:</b>	<a href="http://wago.com/750-8202/000-011">wago.com/750-8202/000-011</a>	
<b>Accessories</b>	<b>Item No.</b>	<b>Page</b>
SD memory card; 2 GB	758-879/000-001	470
WAGO Communication Cable	750-923	469

<sup>1)</sup>Library for e!RUNTIME

\*For memory configuration via e!RUNTIME, the program and data memory together have a maximum size of 60 MB and can be distributed dynamically.

Suitable software application:

- Machine Data Collection with MTConnect
- Room Management with flexROOM®

see Section 1

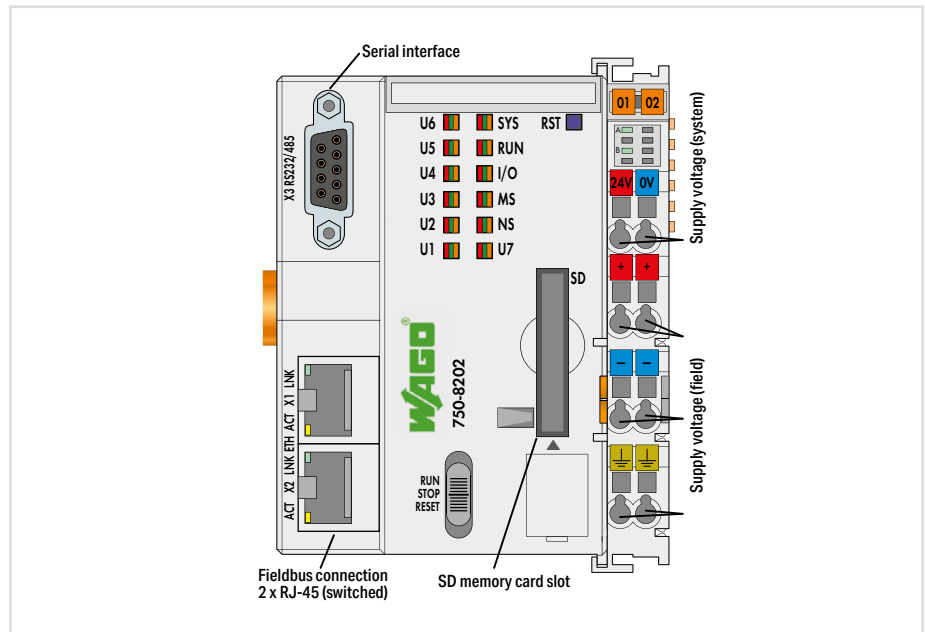
„ Software e!COCKPIT, WAGO-I/O-PRO V2.3, see Section 2, page 26 and 32

„ Mini-WSB marker card and mounting accessories, see Section "Accessories and Tools"

## Controller PFC200; FG2; 2 x ETHERNET; RS-232/-485



Figure: 750-8202



Item description	Controller PFC200; FG2; 2 x ETHERNET; RS-232/-485	
Item No.	750-8202/000-012	
Order text	PFC200; FG2; 2ETH RS	
<b>Technical Data</b>		
Communication	Modbus (TCP, UDP, RTU); EtherNet/IP adapter (slave) <sup>1)</sup> ; RS-232/-485 interface	
ETHERNET protocols	DHCP; DNS; NTP; FTP; FTPS; SNMP; HTTP; HTTPS; SSH	
Visualization	Web-Visu	
Programming	WAGO-I/O-PRO V2.3 (based on CODESYS V2.3); e!COCKPIT (based on CODESYS V3)	
CPU	Cortex A8; 600 MHz	
Operating system	Real-time Linux (with RT-Preempt patch)	
Main memory (RAM)/internal memory (flash)/non-volatile memory (hardware)	256 MB / 256 MB / 128 KB	
Program memory/data memory/non-volatile memory (software)	CODESYS V2:	16 MB / 64 MB / 128 KB
	e!RUNTIME:	60 MB* / 60 MB* / 128 KB
Number of I/O modules per node (max.)	250	
Input and output process image (internal) max.	1000 words	
Input and output process image (MODBUS) max.	CODESYS V2:	1000 words
	e!RUNTIME:	32000 words
Supply voltage (system)	24 VDC (-25 ... 30 %); via wiring level (CAGE CLAMP® connection)	
Supply voltage (field)	24 VDC (-25 ... +30 %); via power jumper contacts	
Input current (typ.) at nominal load (24 V)	550 mA	
Total current (system supply)	1700 mA	
Surrounding air temperature (operation)	0 ... +55 °C	
Dimensions W x H x D	78.6 x 71.9 x 100 mm	
Approvals	CE; Marine; OrdLoc/HazLoc; ATEX/IECEX	
Data sheet and further information, see:	<a href="http://wago.com/750-8202/000-012">wago.com/750-8202/000-012</a>	
<b>Accessories</b>		
SD memory card; 2 GB	Item No.	Page
	758-879/000-001	470
WAGO Communication Cable	750-923	469

<sup>1)</sup>Library for e!RUNTIME

\*For memory configuration via e!RUNTIME, the program and data memory together have a maximum size of 60 MB and can be distributed dynamically.

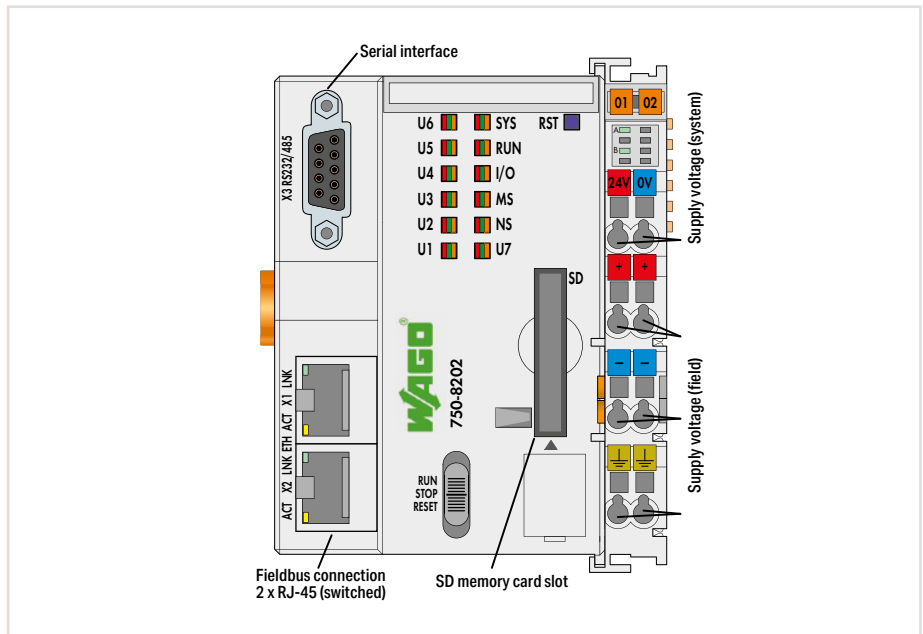
Suitable software application:

- Machine Data Collection with MTConnect
  - Lighting Management
- see Section 1

# Controller PFC200; Energy Data Management Application; 2 x ETHERNET; RS-232/-485



Figure: 750-8202



4.1

<b>Item description</b>	<b>Controller PFC200; Energy data management application; 2 x ETHERNET; RS-232/-485</b>
<b>Item No.</b>	<b>750-8202/000-022</b>
<b>Order text</b>	PFC200; FGE; 2ETH RS
<b>Technical Data</b>	
Communication	Modbus (TCP, UDP, RTU); EtherNet/IP adapter (slave) <sup>1)</sup> ; RS-232/-485 interface
ETHERNET protocols	DHCP; DNS; NTP; FTP; HTTPS; SNMP; HTTP; HTTPS; SSH
Visualization	Web-Visu
Programming	WAGO-I/O-PRO V2.3 (based on CODESYS V2.3); e!COCKPIT (based on CODESYS V3)
CPU	Cortex A8; 600 MHz
Operating system	Real-time Linux (with RT-Preempt patch)
Main memory (RAM)/internal memory (flash)/non-volatile memory (hardware)	256 MB / 256 MB / 128 KB
Program memory/data memory/non-volatile memory (software)	CODESYS V2: 16 MB / 64 MB / 128 KB e!RUNTIME: 60 MB* / 60 MB* / 128 KB
Number of I/O modules per node (max.)	250
Input and output process image (internal) max.	1000 words
Input and output process image (MODBUS) max.	CODESYS V2: 1000 words e!RUNTIME: 32000 words
Supply voltage (system)	24 VDC (-25 ... 30 %); via wiring level (CAGE CLAMP® connection)
Supply voltage (field)	24 VDC (-25 ... +30 %); via power jumper contacts
Input current (typ.) at nominal load (24 V)	550 mA
Total current (system supply)	1700 mA
Surrounding air temperature (operation)	0 ... +55 °C
Dimensions W x H x D	78.6 x 71.9 x 100 mm
<b>Approvals</b>	CE; Marine; OrdLoc/HazLoc; ATEX/IECEX
<b>Data sheet and further information, see:</b>	<a href="http://wago.com/750-8202/000-022">wago.com/750-8202/000-022</a>
<b>Accessories</b>	
SD memory card; 2 GB	<b>Item No.</b> 758-879/000-001 <b>Page</b> 470
WAGO Communication Cable	750-923 469

<sup>1)</sup>Library for e!RUNTIME

\*For memory configuration via e!RUNTIME, the program and data memory together have a maximum size of 60 MB and can be distributed dynamically.

Suitable software application:

- Energy Data Management see Section 1

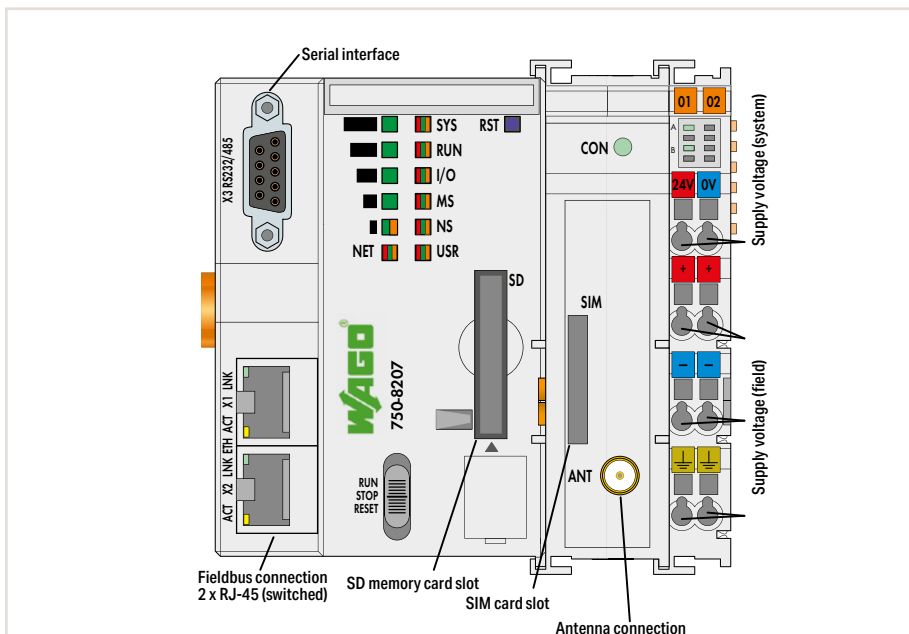
„ Software e!COCKPIT, WAGO-I/O-PRO V2.3, see Section 2, page 26 and 32

„ Mini-WSB marker card and mounting accessories, see Section "Accessories and Tools"

# Controller PFC200; Energy Data Management Application; 2 x ETHERNET; RS-232/-485; Mobile Radio Module



Figure: 750-8207



4.1

<b>Item description</b>	<b>Controller PFC200; Energy data management application; 2 x ETHERNET; RS-232/-485; Mobile radio module</b>	
<b>Item No.</b>	750-8207/000-022	
<b>Order text</b>	PFC200; FGE; 2ETH RS 3G	
<b>Technical Data</b>		
Communication	Modbus (TCP, UDP, RTU); EtherNet/IP adapter (slave) <sup>1)</sup> ; RS-232/-485 interface	
ETHERNET protocols	DHCP; DNS; NTP; FTP; FTPS; SNMP; HTTP; HTTPS; SSH	
Radio technology	GSM/Edge/UMTS/HSPA+	
Frequency band	GSM quad-band	
Services	SMS (bidirectional); GPRS connection to Internet	
Security encryption	OpenVPN; IPsec; firewall	
Visualization	Web-Visu	
Programming	WAGO-I/O-PRO V2.3 (based on CODESYS V2.3); e!COCKPIT (based on CODESYS V3)	
CPU	Cortex A8; 600 MHz	
Operating system	Real-time Linux (with RT-Preempt patch)	
Main memory (RAM)/internal memory (flash)/non-volatile memory (hardware)	256 MB / 256 MB / 128 KB	
Program memory/data memory/non-volatile memory (software)	CODESYS V2:	16 MB / 64 MB / 128 KB
	e!RUNTIME:	60 MB* / 60 MB* / 128 KB
Number of I/O modules per node (max.)	250	
Input and output process image (internal) max.	1000 words	
Input and output process image (MODBUS) max.	CODESYS V2:	1000 words
	e!RUNTIME:	32000 words
Supply voltage (system)	24 VDC (-25 ... 30 %); via wiring level (CAGE CLAMP® connection)	
Supply voltage (field)	24 VDC (-25 ... +30 %); via power jumper contacts	
Input current (typ.) at nominal load (24 V)	550 mA	
Total current (system supply)	700 mA	
Surrounding air temperature (operation)	0 ... +55 °C	
Dimensions W x H x D	102.5 x 71.9 x 100 mm	
<b>Approvals</b>	CE, OrdLoc	
<b>Data sheet and further information, see:</b>	<a href="http://wago.com/750-8207/000-022">wago.com/750-8207/000-022</a>	
<b>Accessories</b>	<b>Item No.</b>	<b>Page</b>
SD memory card; 2 GB	758-879/000-001	470
WAGO Communication Cable	750-923	469
Antenna; GSM	758-965	471

<sup>1)</sup>Library for e!RUNTIME

\*For memory configuration via e!RUNTIME, the program and data memory together have a maximum size of 60 MB and can be distributed dynamically.

Suitable software application:

- Energy Data Management
- see Section 1



# Controllers PFC200 XTR

## Touch-Panel 600 Standard/Advanced Line; Hardware configuration Control Panel

- Merging of control and visualization
- 10.9 ... 25.7 cm (4.3 ... 10.1")

◀ Section 3

## Controllers PFC200 XTR

The advantages of the PFC Controller combined with the capabilities for extreme environments:

- High processing speed
- Multiple interfaces
- eXTRemely robust and maintenance-free

Section 4.3 ▶

## Controllers 750 XTR

For demanding applications in which the following are critical:

- Extreme temperature stability
- Immunity to electromagnetic interference and impulse voltages
- Vibration and shock resistance

Section 4.4 ▶▶

## Controllers PFC100/PFC200

- Maximum performance in a minimum space
- Also programmable in high-level languages based on Linux®
- Security packages with SSH and SSL/TLS
- Runtime system for CODESYS V2 (only PFC200) and V3

◀ Section 4.1

## Controllers 750

- Controllers for all prominent fieldbus systems
- Programmable to IEC 61131-3
- Combinable with the modules of the WAGO-I/O-SYS-TEM 750

## Starter Kits

To get you up and running quickly, we offer starter kits to suit the most diverse applications:

- With Controller PFC100
- With Controller PFC200
- With Controller 750 ETHERNET
- With Controller 750 KNX IP or BACnet/IP





Section 4.5 ▶▶▶



# Controllers PFC200 XTR

## Contents

	Page
General Product Information	96
Versions	97
Interfaces and Types	97
Item Number Key	97
Installation Instructions	98
Standards and Rated Conditions for Rail Applications (EN 50155)	98
Standards and Rated Conditions	99
Approvals	99

CPU	Modbus (TCP, UDP)	EtherNet/IP	PROFIBUS	CANopen	Modbus RTU	Telecontrol Protocols: IEC 60870, IEC 61850/61400, DNP3	IoT Protocols: MQTT	Description	Item No.	
 Cortex A8; 600 MHz	M/S	S			x		x	Controller PFC200; 2 x ETHERNET, RS-232/-485; extreme	750-8202/040-000	100
 Cortex A8; 600 MHz	M/S	S			x	x	x	Controller PFC200; 2 x ETHERNET, RS-232/485; Telecontrol technology; extreme	750-8202/040-001	100
 Cortex A8; 600 MHz	M/S	S	S	M/S	x		x	Controller PFC200; 2 x ETHERNET, RS-232/-485, CAN, CANopen, PROFIBUS Slave; extreme	750-8206/040-000	101
 Cortex A8; 600 MHz	M/S	S	S	M/S	x	x	x	Controller PFC200; 2 x ETHERNET, RS-232/-485, CAN, CANopen, PROFIBUS Slave; Telecontrol technology; extreme	750-8206/040-001	101

M: Master, S: Slave

4.2  
Controllers  
PFC200 XTR

## Controllers PFC200 XTR

### General Product Information

#### PFC200 XTR:

##### Taking It to the eXTReme – The Standard for 750 XTR

With the dark gray XTR version of the PFC200 Controller, you will benefit from the unique added value of this fast and highly communicative multi-talented controller for applications that are subjected to extreme environments.

The PFC200 XTR Controller excels with high processing speed and multiple interfaces for parallel communication. All variants of this controller feature two ETHERNET ports and – depending on the model – additional interfaces. The CANopen, PROFIBUS DP and MODBUS TCP/UDP/RTU protocols provide a flexible connection to fieldbus systems and external input/output devices. These fieldbus systems can be easily configured directly in WAGO's easy-to-use e!COCKPIT development environment. The ETHERNET interfaces with an integrated switch also support all major IT protocols. In addition to multiple interfaces, the PFC200 XTR offers ample memory for your applications, provided by the internal flash memory and an integrated interface for SD/SDHC cards.

Extremely temperature-resistant, immune to interference, as well as unfazed by vibrations and impulse voltages – WAGO's 750 XTR is the first choice for demanding applications including:

- Marine systems and onshore/offshore industry
- Renewable energy systems (wind turbines, solar systems and biogas plants)
- Transformer stations and power distribution systems
- Petrochemical processing
- Water and wastewater treatment systems
- Custom machines
- Railway applications

#### Industry 4.0 / IoT

Recording, digitizing and linking data profitably – this is the core concept behind Industry 4.0. Using a dedicated library, the WAGO PFC100 and PFC200 Controllers now become IoT controllers that send data from the field level to the cloud. Here, they can be aggregated and used for analysis. This creates true added value for your company – be it for increasing the efficiency of in-house production, implementing energy management in buildings, or developing further end customer services. Existing systems also become IoT-ready, making them sustainable into the future. The WAGO PFC family of controllers thus forms the basis for a sustainable corporate world.

#### Link between Process Data and IT Application – Even under eXTReme Conditions

The PFC200 XTR ideally combines real-time requirements with IT functionality. It supports both MODBUS/TCP and ETHERNET/IP for use in industrial environments. HTTP, SNMP, FTP, BootP, DHCP, DNS and other protocols simplify integration into IT environments. Integrated Web pages and Web-based visualization provide IT applications with real-time process data. Furthermore, the 750 Series Controllers incorporate library functions for email, SOAP, ASP, IP configuration, ETHERNET sockets and file system.

#### Security on Board

The topics of ETHERNET communication and security are closely linked. To provide PFC Controller users with a high level of security, mechanisms for secure connections such as HTTPS, FTPS, SSH and SSL/TLS are standard.

#### Worldwide Approvals

International approvals for industrial automation, building technology, shipbuilding and onshore/offshore applications guarantee worldwide use even under harsh operating conditions, e.g., Germanischer Lloyd, Det Norske Veritas, American Bureau of Shipping, Korean Register of Shipping, Nippon Kaiji Kyokai, Registro Italiano Navale and Polski Rejestr Stratkow.

#### Superior Reliability in Extreme Climates

Engineered for freezing cold, extreme heat and high humidity, the WAGO-I/O-SYSTEM 750 XTR provides absolute dependability in virtually any weather. The XTR version of the PFC200 is unfazed by both freezing cold down to -40°C and scorching heat up to +70°C. And this applies equally for both start-up and ongoing operation. The maximum approved operating altitude of 5,000 m is another highlight. Even in the thin air of a mountain-top station, the system impressively demonstrates its high performance and availability.

#### Additional Protection Against Interference Pulses

The WAGO-I/O-SYSTEM 750 XTR provides greater isolation up to 5 kV of impulse voltage, lower EMC emission of interference and higher insensitivity to EMC interference. These strengths add up to trouble-free operation.

#### High Mechanical Performance

Automation systems must be incredibly vibration-resistant, especially when installed close to vibration-prone and shock-generating system components. Powerful motors and power circuit breakers are just two examples from a wide range of applications that can stress automation systems. The WAGO-I/O-SYSTEM 750 XTR continues to set new standards here. Count on long-lasting, trouble-free operation and industry-topping levels of safety – even in the most severe applications, such as tunnel boring machines.

#### Modular and Expandable

With the WAGO-I/O-SYSTEM 750 XTR, the PFC200 can be expanded to almost any input/output interface. Using an industry-leading platform, the 750 XTR boasts the same proven benefits.

#### Open-Source Software and Linux®

We unite what belongs together: High-performance WAGO hardware and the future-ready Linux® operating system. WAGO's controllers offer programming in either IEC 61131 or directly in Linux® to create complex tasks. WAGO's "Embedded Linux" Controllers impress with base images that are expandable via open-source packages. As a "Gold Member" of the Open Source Automation Development Lab (OSADL), WAGO supports both financing and further development of Linux® in the industrial sector. The controller firmware itself is available as a "Board Support Package" (BSP).

If you are interested, simply contact our Technical Support *AUTOMATION*.



#### Advantages:

- Controllers for eXTReme environmental conditions
  - No air conditioning required
  - Can be used in unshielded areas
  - Install close to vibrating and shock-generating system components
- Programming per IEC 61131-3
- Can be combined with high-level languages
- Linux® real-time operating system
- Robust and maintenance-free
- Integrated IT security standards
- IoT ready

## Controllers PFC200 XTR Versions

### Telecontrol Technology

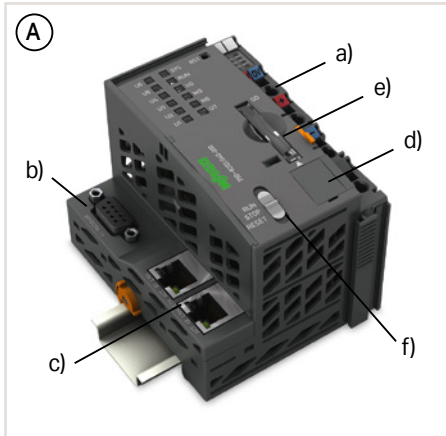
The telecontrol technology versions of the PFC200 are distinguished by their integrated, standardized telecontrol technology:

- IEC 60870-5
- IEC 61850
- IEC 61400-25
- DNP3

The increased requirements for dielectric strength and interference immunity according to EN 60870-2-1 are also completely fulfilled.



## Interfaces and Types



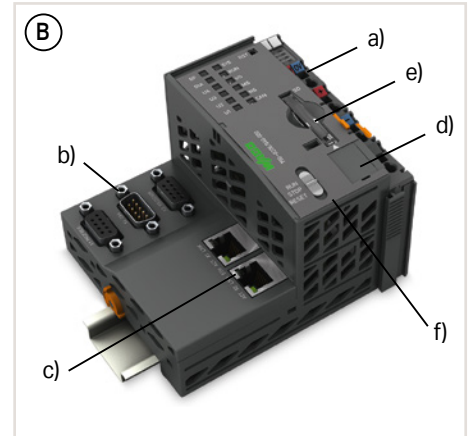
- Including supply module to power downstream I/O modules (a)
- Technical differences on the connection level (b)
- ETHERNET 2 x RJ-45 (c)
- Service interface (d)
- SD card slot for external storage media (e)
- Start/stop switch (f)

Housing design (A)

- W x H x D (mm) 78.6 x 71.9 x 100

Housing design (B)

- W x H x D (mm) 112 x 71.9 x 100



4.2

## Item Number Key

Explanation of the components of an item number key

Item No. : 750-82xx/040-000

02: 2 x ETHERNET, RS-232/-485

06: 2 x ETHERNET, RS-232/-485, CAN, PROFIBUS-DP slave

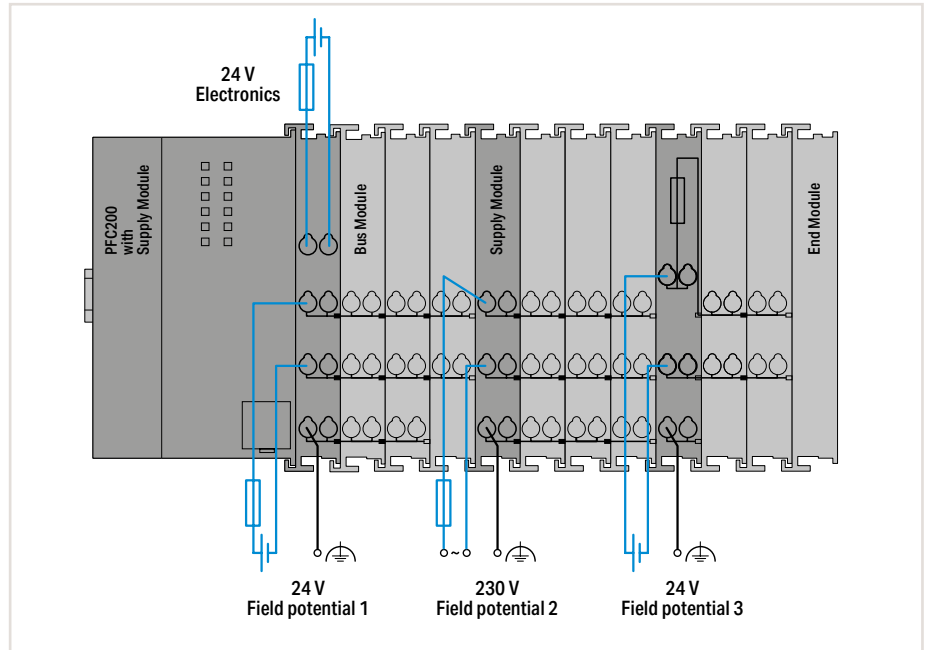
.../040-000: Standard

.../040-001: Telecontrol technology

# Controllers PFC200 XTR Installation Instructions

## Power Supply

The internal electronics are powered by the controller. The power supply to the field-side supply is electrically isolated. The division enables a separate supply for sensors and actuators. Snapping the I/O modules together automatically routes the supply voltages. Supply modules with diagnostics enable additional monitoring of the power supply. This configuration ensures a flexible, user-specific supply design for a station. The current supply to the electronics is limited by a maximum value. If the sum of the internal current demand of all the I/O modules should exceed this value, an additional system supply module is necessary. Even in this case, power supply to the field-side supply of 10 A may not be exceeded. However, different power supply modules allow a new power supply, formation of potential groups and the implementation of emergency stops.



### Notes

Additional steps must be implemented based on where the I/O system is installed:

Specific power and field-side power supply filters (750-624/040-001 or 750-626/040-000) are ready for marine and onshore/off-shore applications, as well as in telecontrol and rail technology.

Please refer to the manual for details about the power supply's design.

### Mixed Operation

Mixed operation (standard/XTR modules) within a node is possible when groups of I/O modules are electrically isolated on the field side, i.e., electrically isolated power supply. The combination may be useful, for example, when there are only increased requirements for dielectric strength and immunity to interference, but the surrounding air temperature is not critical.

4.2

## Standards and Rated Conditions for Rail Applications (EN 50155)

Railway Applications (EN 50155)	Class/Standard Compliance
<b>4.1 Rated operating conditions</b>	
4.1.1 Altitude above sea level	AX (EN 50125-1)
4.1.2 Surrounding air temperature	TX
4.1.3 Shock and vibration	1A and 1B (EN 61373)
4.1.4 Relative humidity	95 % (coated PCBs)
<b>5.1 Power supply</b>	
5.1.1.1 Master voltage fluctuations	
Minimum voltage	0.725 x Un
Maximum voltage	1.3 x Un
5.1.1.2 Power interruptions	S1
<b>5.4 Surge, ESD, burst tests</b>	EN 50121-3-2
<b>5.5 EMC (emission of interference, immunity to interference)</b>	EN 50121-3-2, EN 50121-4, -5
<b>Fire behavior: per EN 45545-2 hazard level HL3</b>	
WAGO is certified in accordance with the IRIS quality standard.	

## Controllers PFC200 XTR

### Standards and Rated Conditions

General Specifications	
Supply voltage (system)	24 VDC (-25 ... +30 %); via wiring level (CAGE CLAMP® connection); Specified values for surrounding air temperature: +15 ... +35 °C For -40 ... +55 °C: 24 V (-25 ... +20 %); For +55 ... +70 °C: 24 V (-25 ... +10 %); Lower limit in all temperature ranges: -27.5 % (including 15 % residual ripple)
Input current (typ.) at nominal load (24 V)	550 mA
Surrounding air temperature (operation)	-40 ... +70 °C
Surrounding air temperature (storage)	-40 ... +85 °C
Relative humidity	Max. 95 %; Short-term condensation per Class 3K7 / IEC EN 60721-3-3 and E DIN 40046-721-3 (except wind-driven precipitation, water and ice formation)
Operating altitude	Without temperature derating: 0 ... 2000 m; With temperature derating: 2000 ... 5000 m (0.5 K/100 m); max.: 5000 m
Pollution degree	2 per IEC 61131-2
Immunity to impulse voltages	Per EN 60870-2-1 510 VAC/775 VDC Isolation: rated surge voltage 1 kV (Class VW1 per EN 60870-2-1) Surge: 1 kV (L - L) / 2 kV (L - E)
Vibration resistance	Per IEC 60068-2-6 (acceleration: 5g); EN 60870-2-2; IEC 60721-3-1, -3; EN 50155; EN 61373
Shock resistance	Per IEC 60068-2-27 (15g/11 ms/half-sine/1,000 shocks; 25g/6 ms/1,000 shocks); EN 50155; EN 61373
EMC immunity to interference	Per EN 61000-6-1, -2; EN 61131-2; Marine applications; EN 50121-3-2, -4, -5; EN 60255-26; EN 60870-2-1; EN 61850-3; IEC 61000-6-5; IEEE 1613; VDEW: 1994
EMC emission of interference	Per EN 61000-6-3, -4; EN 61131-2; EN 60255-26; Marine applications; EN 60870-2-1; EN 61850-3; EN 50121-3-2; -4, -5
Protection type	IP20
Mounting position	Horizontal (standing/lying) or vertical
Mounting type	DIN-35 rail
Housing material	Polycarbonate; polyamid 6.6
Exposure to pollutants	Per IEC 60068-2-42 and IEC 60068-2-43
Permissible SO <sub>2</sub> contaminant concentration at a relative humidity < 75 %	25 ppm
Permissible H <sub>2</sub> S contaminant concentration at a relative humidity < 75 %	10 ppm
Connection technology	CAGE CLAMP®
Conductor cross sections Strip length	0.25 ... 2.5 mm <sup>2</sup> /24 ... 14 AWG 8 ... 9 mm / 0.31 ... 0.35 inch
Current carrying capacity (power jumper contacts)	10 A

4.2

## Approvals

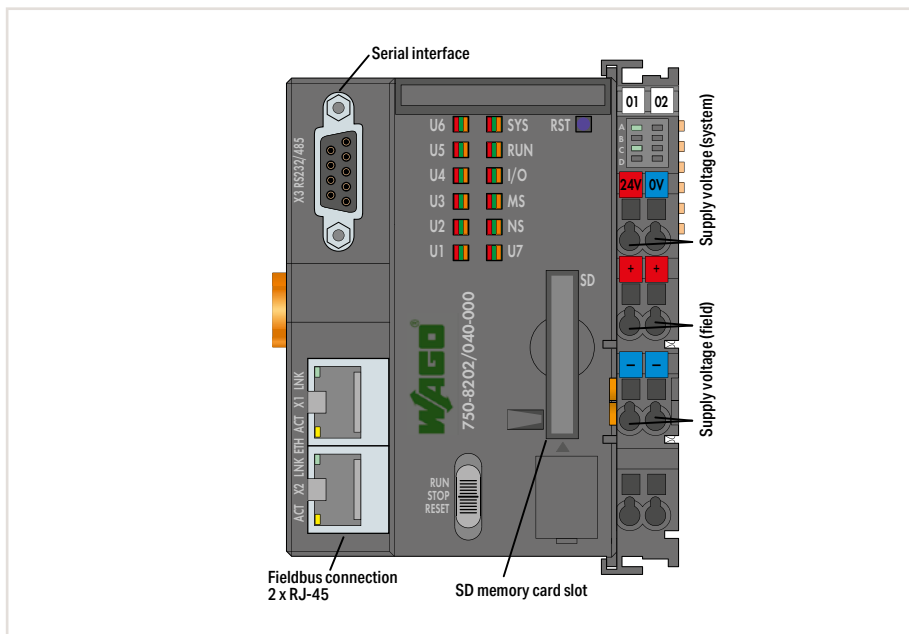
Overview of the approvals in the article comparison in Section 11, Technical Appendix, or online at [www.wago.com](http://www.wago.com)



# Controller PFC200; 2 x ETHERNET, RS-232/-485; Extreme



Figure: 750-8202/040-000



<b>Item description</b>	<b>Controller PFC200; 2 x ETHERNET; RS-232/-485</b>	
<b>Version</b>	<b>Extreme</b>	<b>Telecontrol technology; extreme</b>
<b>Item No.</b>	750-8202/040-000	750-8202/040-001
<b>Order text</b>	PFC200; 2ETH RS; XTR	PFC200; 2ETH RS; Tele; XTR

4.2

<b>Technical Data</b>		
Communication	Modbus (TCP, UDP, RTU); EtherNet/IP adapter (slave) <sup>1)</sup> ; MQTT; RS-232/-485 interface	Modbus (TCP, UDP, RTU); MQTT; Telecontrol protocols; RS-232/-485 interface
ETHERNET protocols	DHCP; DNS; NTP; FTP; FTPS; SNMP; HTTP; HTTPS; SSH	
Telecontrol protocols	IEC 60870-5-101/-103/-104; IEC 61850-7-4; IEC 61400-25; DNP3	
Visualization	Web-Visu	
Programming	WAGO I/O-PRO V2.3 (based on CODESYS V2.3); e!COCKPIT (based on CODESYS V3)	WAGO I/O-PRO V2.3 (based on CODESYS V2.3)
CPU	Cortex A8; 600 MHz	
Operating system	Real-time Linux (with RT-Preempt patch)	
Main memory (RAM)/internal memory (flash)/non-volatile memory (hardware)	256 MB / 256 MB / 128 KB	
Program memory/data memory/non-volatile memory (software)	CODESYS V2:	16 MB / 64 MB / 128 KB
Number of modules per node (max.)	e!RUNTIME:	60 MB* / 60 MB* / 128 KB
Input and output process image (internal) max.	64	
Input and output process image (MODBUS) max.	CODESYS V2:	1000 words
Supply voltage (system)	e!RUNTIME:	32000 words
Supply voltage (field)	24 VDC (-25 ... +30 %); via wiring level (CAGE CLAMP® connection); Specified values for surrounding air temperature: +15 ... +35 °C; For -40 ... +55 °C: 24 V (-25 ... +20 %); For +55 ... +70 °C: 24 V (-25 ... +10 %); Lower limit in all temperature ranges: -27.5 % (including 15 % residual ripple)	
Input current (typ.) at nominal load (24 V)	24 VDC; via power jumper contacts	
Current consumption – system supply (5 V)	550 mA	
Total current (system supply)	510 mA	
Surrounding air temperature (operation)	1700 mA	
Dimensions W x H x D	-40 ... +70 °C	
Approvals	78.6 x 71.9 x 100 mm	
Data sheet and further information, see:	CE; Marine; OrdLoc/HazLoc; ATEX/IECEx	
	<a href="http://wago.com/750-8202/040-000">wago.com/750-8202/040-000</a>	<a href="http://wago.com/750-8202/040-001">wago.com/750-8202/040-001</a>

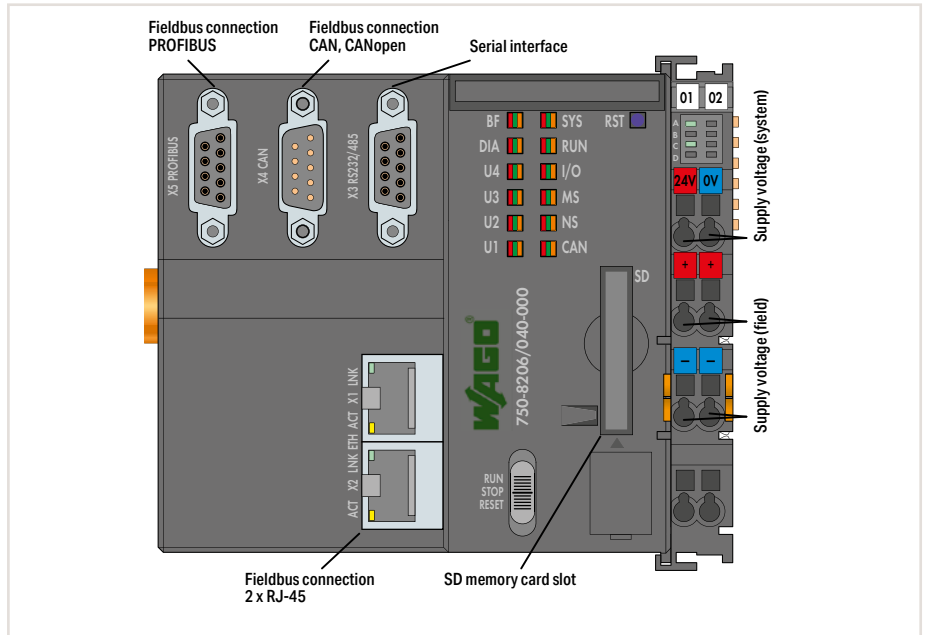
<b>Accessories</b>	<b>Item No.</b>	<b>Page</b>
SD memory card; 2 GB	758-879/000-001	470

<sup>1)</sup>Library for e!RUNTIME  
 \*For memory configuration via e!RUNTIME, the program and data memory together have a maximum size of 60 MB and can be distributed dynamically.

# Controller PFC200; 2 x ETHERNET, RS-232/-485, CAN, CANopen, PROFIBUS Slave; Extreme



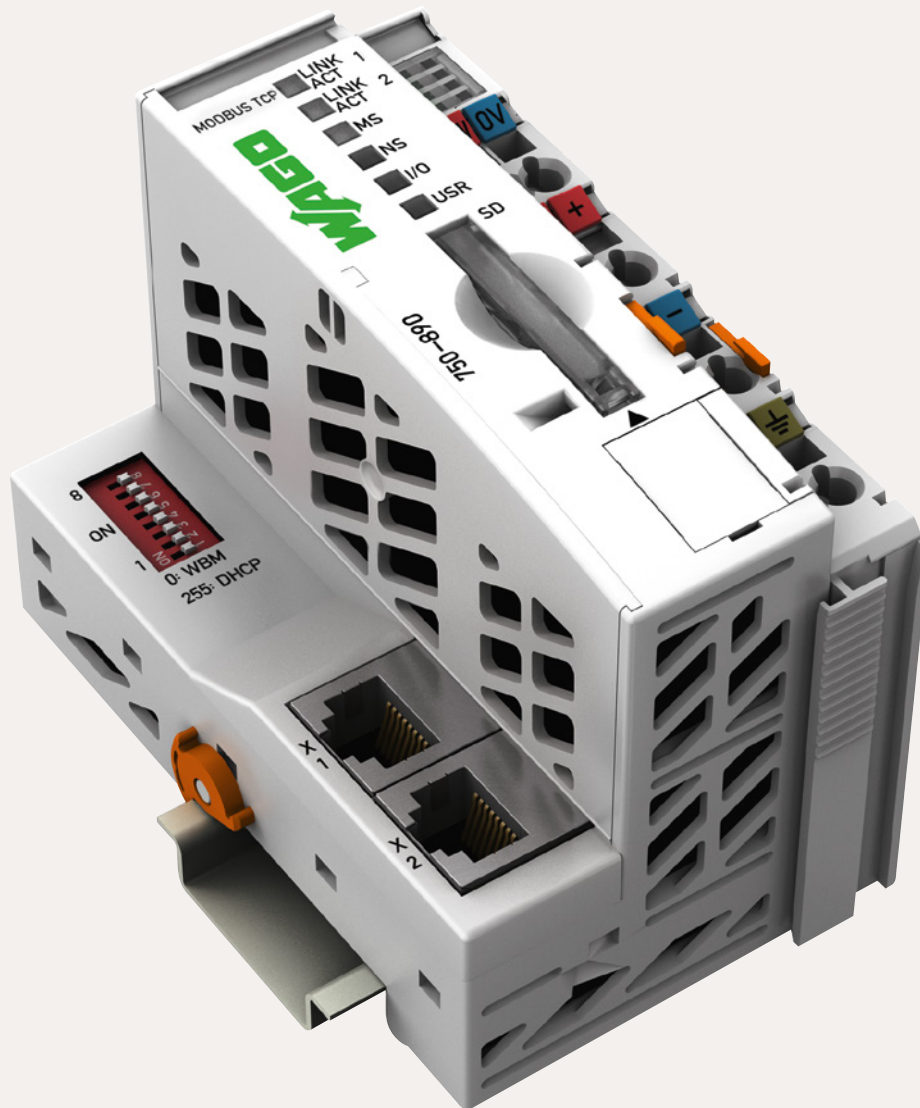
Figure: 750-8206/040-000



<b>Item description</b>		<b>Controller PFC200; 2 x ETHERNET, RS-232/-485, CAN, CANopen, PROFIBUS Slave</b>	
<b>Version</b>		<b>Extreme</b>	
<b>Item No.</b>		<b>750-8206/040-000</b>	
<b>Order text</b>		<b>PFC200; 2ETH RS CAN DPS; XTR</b>	
<b>Technical Data</b>		<b>Telecontrol technology; extreme</b>	
<b>Communication</b>		Modbus (TCP, UDP, RTU); EtherNet/IP adapter (slave)1); MQTT; PROFIBUS; CANopen; RS-232/-485 interface	
<b>ETHERNET protocols</b>		Modbus (TCP, UDP, RTU); MQTT; PROFIBUS; CAN; CANopen; Telecontrol protocols; RS-232/-485 interface	
<b>Telecontrol protocols</b>		DHCP; DNS; NTP; FTP; FTPS; SNMP; HTTP; HTTPS; SSH	
<b>Visualization</b>		IEC 60870-5-101/-103/-104; IEC 61850-7-4; IEC 61400-25; DNP3	
<b>Programming</b>		Web-Visu	
<b>CPU</b>		WAGO-I/O-PRO V2.3 (based on CODESYS V2.3); e!COCKPIT (based on CODESYS V3)	
<b>Operating system</b>		Cortex A8; 600 MHz	
<b>Main memory (RAM)/internal memory (flash)/non-volatile memory (hardware)</b>		Real-time Linux (with RT-Preempt patch)	
<b>Program memory/data memory/non-volatile memory (software)</b>		256 MB / 256 MB / 128 KB	
<b>Number of modules per node (max.)</b>		CODESYS V2: 16 MB / 64 MB / 128 KB	
<b>Input and output process image (internal) max.</b>		e!RUNTIME: 60 MB* / 60 MB* / 128 KB	
<b>Input and output process image (MODBUS)/ (PROFIBUS)/(CAN) max.</b>		64	
<b>Supply voltage (system)</b>		1000 words	
<b>Supply voltage (field)</b>		CODESYS V2: 1000 words / 244 bytes / 2000 words	
<b>Input current (typ.) at nominal load (24 V)</b>		e!RUNTIME: 32000 words / 244 bytes / 2000 words	
<b>Current consumption – system supply (5 V)</b>		24 VDC (-25 ... +30 %); via wiring level (CAGE CLAMP® connection); Specified values for surrounding air temperature: +15 ... +35 °C; For -40 ... +55 °C: 24 V (-25 ... +20 %); For +55 ... +70 °C: 24 V (-25 ... +10 %); Lower limit in all temperature ranges: -27.5 % (including 15 % residual ripple)	
<b>Total current (system supply)</b>		24 VDC; via power jumper contacts	
<b>Surrounding air temperature (operation)</b>		550 mA	
<b>Dimensions W x H x D</b>		600 mA	
<b>Approvals</b>		1700 mA	
<b>Data sheet and further information, see:</b>		-40 ... +70 °C	
<b>Accessories</b>		112 x 71.9 x 100 mm	
<b>SD memory card; 2 GB</b>		CE, Marine; OrdLoc/HazLoc; ATEX/IECEx	
<b>Item No.</b>		wago.com/750-8206/040-000	
<b>Page</b>		wago.com/750-8206/040-001	
<b>758-879/000-001</b>		<b>470</b>	

<sup>1</sup>Library for e!RUNTIME

\*For memory configuration via e!RUNTIME, the program and data memory together have a maximum size of 60 MB and can be distributed dynamically.



# Controllers 750

## Touch-Panel 600 Standard/Advanced Line; Hardware configuration Control Panel

- Merging of control and visualization
- 10.9 ... 25.7 cm (4.3 ... 10.1")

◀◀ Section 3

## Controllers PFC200 XTR

The advantages of the PFC Controller combined with the capabilities for extreme environments:

- High processing speed
- Multiple interfaces
- eXTRemely robust and maintenance-free

◀ Section 4.2

## Controllers 750 XTR

For demanding applications in which the following are critical:

- Extreme temperature stability
- Immunity to electromagnetic interference and impulse voltages
- Vibration and shock resistance

Section 4.4 ▶

## Controllers PFC100/PFC200

- Maximum performance in a minimum space
- Also programmable in high-level languages based on Linux®
- Security packages with SSH and SSL/TLS
- Runtime system for CODESYS V2 (only PFC200) and V3

◀◀ Section 4.1

## Controllers 750

- Controllers for all prominent fieldbus systems
- Programmable to IEC 61131-3
- Combinable with the modules of the WAGO-I/O-SYS-TEM 750

## Starter Kits

To get you up and running quickly, we offer starter kits to suit the most diverse applications:

- With Controller PFC100
- With Controller PFC200
- With Controller 750 ETHERNET
- With Controller 750 KNX IP or BACnet/IP







Section 4.5 ▶▶



# Controllers 750

## Contents

	Page
General Product Information	104
Versions	105
Interfaces and Types	105
Item Number Key	105
Installation Instructions	106
Standards and Rated Conditions	107
Approvals	107

CPU	ETHERNET								Description	Item No.				
	Modbus (TCP, UDP)	EtherNet/IP	BACnet/IP	KNX IP	Modbus RTU	Telecontrol Protocols: IEC 60870, IEC 61850/61400, DNP3	BACnet MS/TP	DeviceNet		PROFIBUS	CANopen		Default	Ext. Temperature
	32 bits	M/S	S								Controller ETHERNET; 3rd generation; SD card slot	750-880	750-880/025-000	108
		M/S	S			x					Controller ETHERNET; 3rd generation; SD card slot; Telecontrol technology; Ext. temperature		750-880/025-001	108
		M/S	S			x					Controller ETHERNET; 3rd generation; SD card slot; Telecontrol technology; Ext. temperature; Eco		750-880/025-002	108
		M/S									Controller Modbus TCP; 4th generation; SD card slot	750-890		109
		M/S	S								Controller ETHERNET; 3rd generation	750-881		109
		M/S									Controller Modbus TCP; 4th generation	750-891		109
		M/S	S								Controller ETHERNET; 3rd generation; SD card slot; Media redundancy	750-885	750-885/025-000	110
		M/S	S								Controller ETHERNET; 3rd generation; Media redundancy	750-882		110
		32 bits	M/S	S							Controller ETHERNET; 3rd generation; Eco	750-852		111
			M/S								Controller Modbus TCP; 4th generation; Eco	750-862		111
	16 bits	M/S									Controller ETHERNET; 1st generation	750-842		112
		M/S									Controller ETHERNET; 1st generation; Eco	750-843		112
	32 bits	M/S		x							Controller KNX/IP	750-889		113
	32 bits	M/S	x								Controller BACnet/IP	750-831		114
		M/S	x								Controller BACnet/IP; Eco	750-831/000-002		114
	32 bits	M/S					x				Controller BACnet MS/TP	750-829		115
	16 bits							x			Controller DeviceNet	750-806		116
	16 bits				x						Controller MODBUS; RS-485; 115.2 kBd	750-815/300-000	750-815/325-000	117
					x						Controller MODBUS; RS-232; 115.2 kBd	750-816/300-000		117
	16 bits								S		Controller PROFIBUS Slave	750-833	750-833/025-000	118
	16 bits									M/S	Controller CANopen; 128/64 KB Program/RAM; MCS	750-837		119
										Controller CANopen; 640/832 KB Program/RAM; MCS	750-837/021-000		119	
									M/S	Controller CANopen; 128/64 KB Program/RAM; D-Sub	750-838		119	
										Controller CANopen; 640/832 KB Program/RAM; D-Sub	750-838/021-000		119	

M: Master, S: Slave

## Controllers 750

### General Product Information

#### Controllers 750:

##### Open – Flexible – Compact

WAGO's controllers are ideal for a wide variety of applications ranging from industrial, process and building automation to measurement and data collection. Based on the fieldbus couplers for all standard fieldbus systems, they are programmable to IEC 61131-3. Direct connection to a wide range of I/O modules from the WAGO-I/O-SYSTEM 750 optimizes adaptation to the application.

##### Building Automation

Thanks to specific characteristics, controllers for the BACnet/IP and KNX IP bus systems are optimized for building automation. The diverse product range of stackable I/O modules allows integration of external systems such as lighting control (DALI), sun protection (SMI), wireless switches (EnOcean) and much more.

##### Marine Systems and Onshore/Offshore Industry

International approvals coupled with industry-specific features permit use in shipbuilding and other harsh sectors. Addressing requirements inherent in specific industries and operating environments has enabled use on marine diesels and in the EMC-sensitive area of a vessel's bridge. Because the requirements are significantly greater for immunity to interference or emission of interference, along with superior mechanical performance in these sensitive areas, the WAGO-I/O-SYSTEM can readily meet the needs of other industries.

##### Telecontrol Technology

Standardized IEC 60870-5, IEC 61850 or IEC 61400-25 telecontrol protocols allow the 750 Series Controllers to be used in telecontrol applications.

##### Starter Kits

For a quick start, WAGO offers every customer the unique opportunity to purchase a starter kit that already contains all the components needed to begin programming and getting to know the controllers. For starter kits, see Section 4.5.

#### Link between Process Data and IT Application

The controllers ideally combine real-time requirements with IT functionality. They support Modbus/TCP and EtherNet/IP for use in industrial environments. HTTP, HTTPS, SNMP, FTP, BootP, DHCP, DNS and other protocols simplify integration into IT environments. Integrated Web pages and Web-based visualization provide IT applications with real-time process data. Furthermore, the 750 Series Controllers incorporate library functions for email, SOAP, ASP, IP configuration, ETHERNET sockets and file system.

#### Worldwide Approvals

International approvals for building and industrial automation, as well as the process and marine industries, guarantee worldwide use – even under harsh operating conditions. These recognitions include: ATEX, BR-Ex, IECEx, UL508, UL ANSI/ISA, AEx and numerous marine certifications.

#### Modular and Expandable

With the WAGO-I/O-SYSTEM 750, the 750 Series Controllers can be expanded to almost any input/output interface. A modular, DIN-rail-mount design permits easy installation, expansion and modification of the I/O node without tools.

The straightforward design prevents installation errors. In addition, proven CAGE CLAMP® technology offers fast, vibration-proof and maintenance-free connections that are independent of operator skill. Depending on the I/O module's granularity, field levels can be directly wired using 1-, 2-, 3- or 4-wire technology.

#### Maximum Reliability and Ruggedness

The WAGO-I/O-SYSTEM is engineered and tested for use in the most demanding environments (e.g., temperature cycling, shock/vibration loading and ESD) according to the highest standards. Spring pressure connection technology guarantees continuous operation. Integrated QA measures in the production process and 100% function testing ensure consistent quality.



#### Advantages:

- Controllers for all prominent fieldbus systems
- Industry-specific features
- Programmable via CODESYS per IEC 61131-3
- Expandable with the comprehensive WAGO-I/O-SYSTEM 750 product range
- Extensive IT integration possibilities
- Tested and approved worldwide
- Maintenance-free

# Controllers 750 Versions

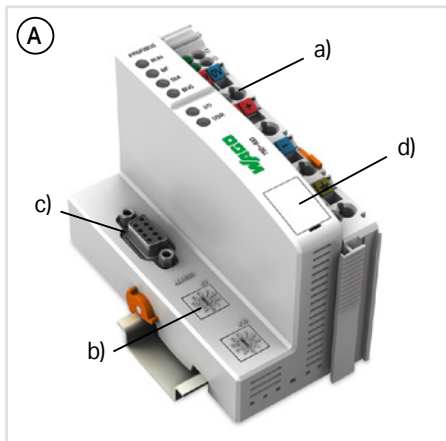
## Extended Temperature Range

Industrial automation technology is typically operated in temperatures ranging from 0°C to 55°C. However, there are applications that require an extended temperature range. Select controllers are available in an extended temperature range of -20°C to +60°C.



For extreme applications, where even this extended temperature range is not sufficient, the WAGO- I/O-SYSTEM 750 XTR is available.

## Interfaces and Types



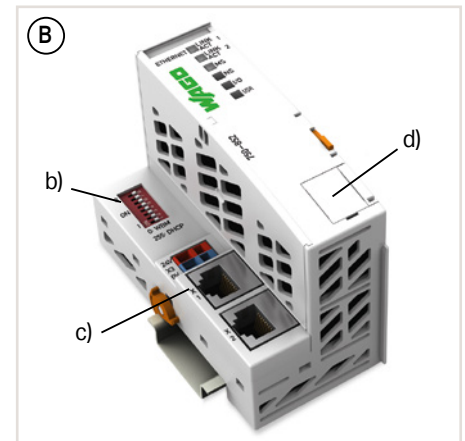
- Technical differences on the connection level; optional addressing switch (b) and fieldbus interface (c)
- Service interface (d)

### Housing design (A)

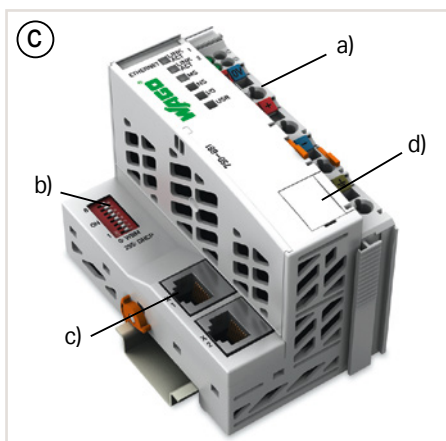
- Including supply module to power downstream I/O modules (a)
- W x H x D (mm) 50.5 x 71.1 x 100

### Housing design Eco (B)

- W x H x D (mm) 49.5 x 71.9 x 96.8



(B)

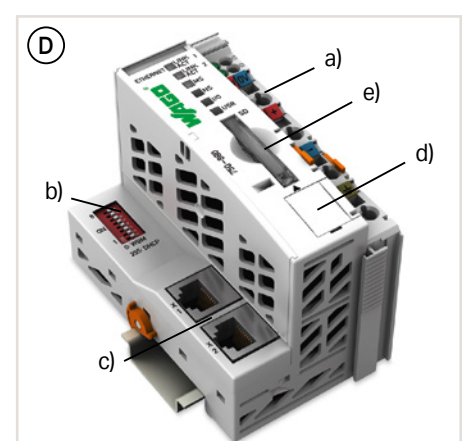


### Housing design (C)

- Including supply module to power downstream I/O modules (a)
- W x H x D (mm) 61.5 x 71.9 x 100

### Housing design (D)

- Including supply module to power downstream I/O modules (a)
- SD card slot for external storage media (e)
- W x H x D (mm) 61.5 x 71.9 x 100



(D)

## Item Number Key

Explanation of the components of an item number key

Item No.: 750-8xx

0x, 1x: 16-bit CPU

2x, 3x:

4x:

5x, 6x: 32 bits

7x, 8x: 32-bit multitasking

.../025-000: Extended temperature range of -20 ... +60 °C

INTERBUS, DeviceNet, MODBUS

BACnet, PROFIBUS, CANopen

ETHERNET

ETHERNET Eco

ETHERNET, telecontrol technology, media redundancy,

KNX IP

# Controllers 750 Installation Instructions

## Power Supply

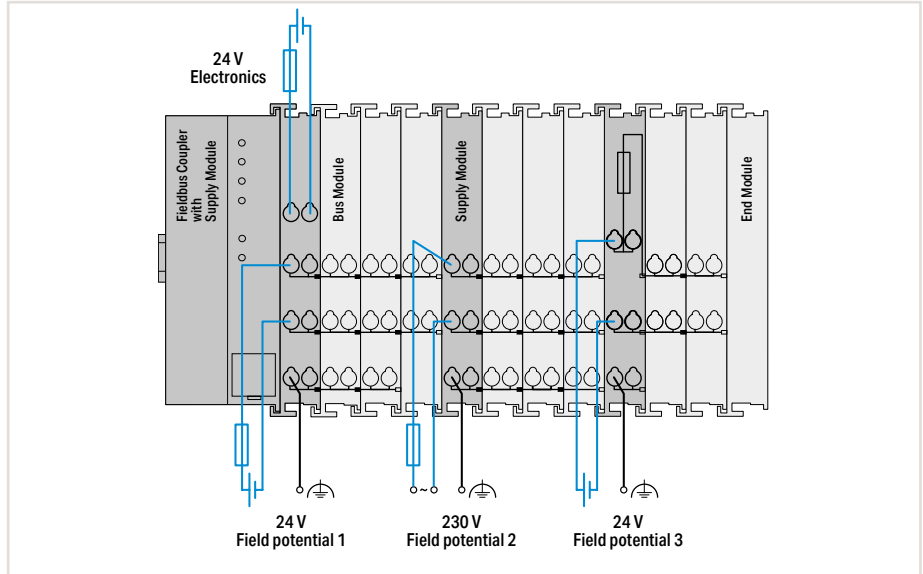
The internal electronics are powered by the controller. The field-side power supply is electrically isolated via the supply module on the controller or a separate power supply module. The division enables a separate supply for sensors and actuators. Snapping the I/O modules together automatically routes the supply voltages (system power supply 5 VDC via the data contacts and field supply via the optional power jumper contacts). Supply modules with diagnostics enable additional monitoring of the power supply. This ensures a flexible, user-specific supply design for a station.

The current supply to the electronics is limited by a maximum value. This value is dependent on the controller used. If the sum of the internal current demand of all the I/O modules should exceed this value, an additional system supply module is necessary. Even in this case, power supply to the field-side supply of 10 A may not be exceeded. However, different power supply modules allow a new power supply, formation of potential groups and the implementation of emergency stops.

### Interference-Free in Safety-Related Applications

**4.3** To easily and safely perform cost-effective, centralized deactivation of complete actuator groups, the actuator's power supply can be switched off using a safety switching device. This can either be performed for each individual actuator or by turning off the power supply to a group of control outputs. In the event of failure, ensure that no interference from other current or power circuits occurs – even when the control voltage is switched off – so the defined safety function properties (logic and time response) remain unchanged.

Some modules are designed to provide interference-free safety functionality. These modules comply with safety requirements up to Category 4 of DIN EN ISO 13849-1:2007. Safety category and performance level depend solely on the safety components and their wiring.



### Notice:

WAGO's interference-free I/O modules are not a component of the safety function and do not replace the safety switching device! When using the components in safety functions, the corresponding notes must be observed in the relevant manual.

### Notes

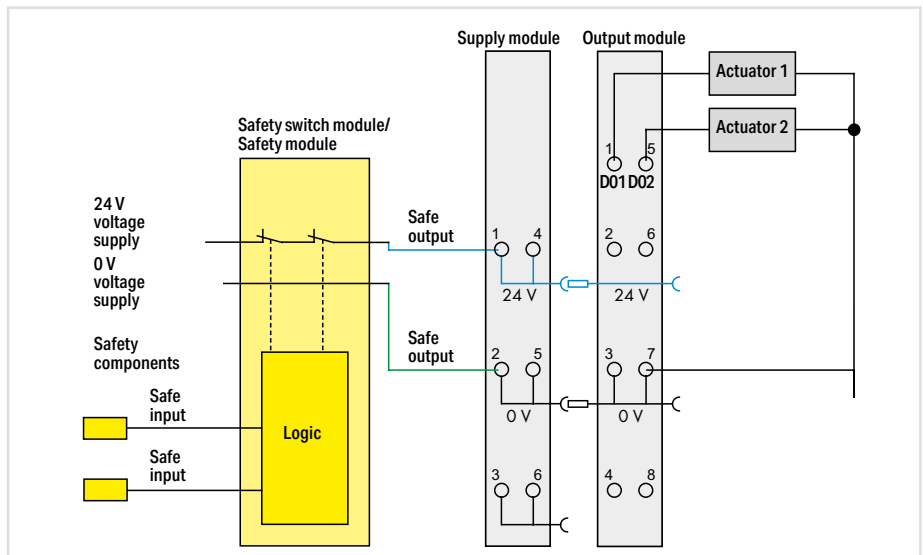
Additional steps must be implemented based on where the I/O system is installed:

- Specific power and field-side power supply filters (750-624 or 750-626) are required for marine and onshore/offshore applications.
- A specific supply module (750-606) is required to operate intrinsically safe Ex i modules.

Additionally, both a supply module and a field-side power supply filter are recommended when operating intrinsically safe Ex i modules for marine and onshore/offshore applications.

As part of operating safety-related I/O modules, PELV/SELV power supply units must be used for 24 VDC supply of electronics and field. In addition, specific power and field-side power supply filters must be provided (750-626).

Please refer to the manual for details about the power supply's design.



Example: 2-channel, double-pole power supply disconnection

## Controllers 750

### Standards and Rated Conditions

General Specifications	
Supply voltage (system)	24 VDC (-25 ... +30 %)*; *for all marine-certified controllers
Isolation	500 V (system/supply)
Surrounding air temperature (operation)	0 ... +55 °C
Surrounding air temperature (operation) for versions with an extended temperature range	-20 ... +60 °C
Surrounding air temperature (storage)	-40 ... +85 °C
Relative humidity	95 % (non condensing)
Relative humidity for versions with an extended temperature range	Max. 95 %, short-term condensation per Class 3K6 / IEC EN 60721-3-3 and E DIN 40046-721-3, taking a temperature range of -20 to +60 °C into consideration (except wind-driven precipitation, water and ice formation)
Operating altitude	0 ... 2000 m
Pollution degree	2 per IEC 61131-2
Vibration resistance	0.5g (4g for all marine-certified controllers) per IEC 60068-2-6
Shock resistance	15g per IEC 60068-2-27
EMC immunity to interference	Per EN 61000-6-2
EMC emission of interference	Per EN 61000-6-3, EN 61000-6-4
Protection type	IP20
Mounting type	DIN-35 rail mounting
Housing material	Polycarbonate; polyamid 6.6
Exposure to pollutants	Per IEC 60068-2-42 and IEC 60068-2-43
Permissible SO <sub>2</sub> contaminant concentration at a relative humidity < 75 %	25 ppm
Permissible H <sub>2</sub> S contaminant concentration at a relative humidity < 75 %	10 ppm
Connection technology	CAGE CLAMP®
Conductor cross sections; strip length for standard controllers: Eco Controllers:	0.08 ... 2.5 mm <sup>2</sup> /28 ... 14 AWG; 8 ... 9 mm / 0.31 ... 0.35 inch 0.08 ... 1.5 mm <sup>2</sup> /28 ... 16 AWG; 5 ... 6 mm / 0.2 ... 0.24 inch
Current carrying capacity (power jumper contacts)	10 A

4.3

## Approvals

Overview of the approvals in the article comparison in Section 11, Technical Appendix, or online at [www.wago.com](http://www.wago.com)



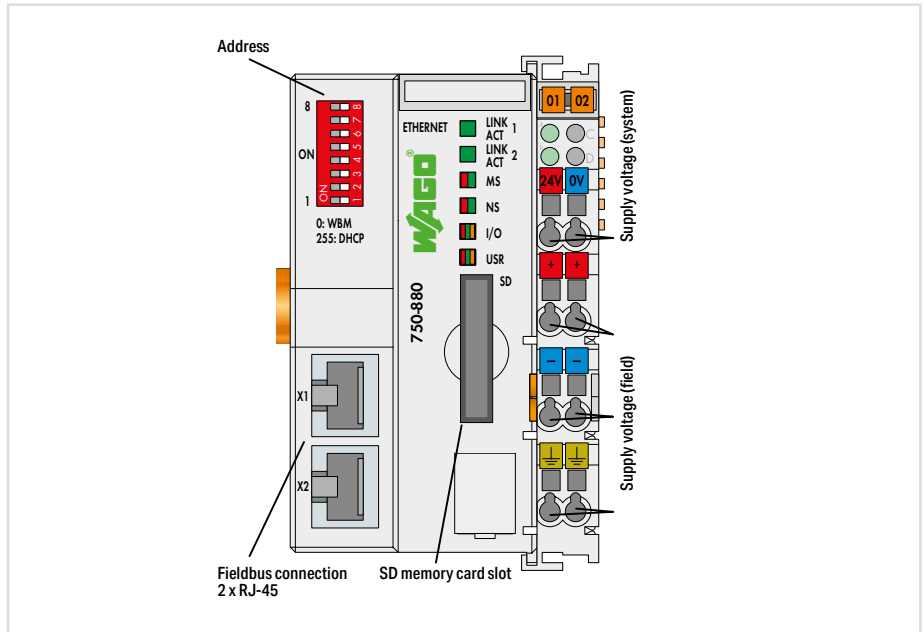
# Controller ETHERNET; Modbus TCP



Figure: 750-880



Figure: 750-881



<b>Item description</b>
Version
Item No.
Order text

Controller ETHERNET; 3rd generation; SD card slot			
Default	Ext. temperature	Telecontrol technology; ext. temperature	Telecontrol technology; ext. temperature; Eco
750-880	750-880/025-000	750-880/025-001	750-880/025-002
Controller ETHERNET; G3; SD	Controller ETHERNET; G3; SD; T	Controller ETHERNET; G3; SD; Tele; T	Controller ETHERNET; G3; SD; Tele; T; Eco

For new installations, please consider the 750-890 Controller with extended functionality.

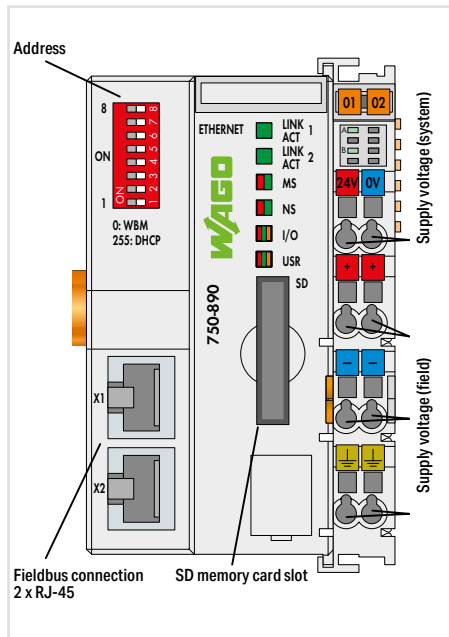
## 4.3

Technical Data	
Communication	EtherNet/IP; Modbus (TCP, UDP)
ETHERNET protocols	HTTP; BootP; DHCP; DNS; SNTP; FTP; SNMP
Telecontrol protocols	IEC 60870-5-101/-103/-104; IEC 61850-7-4; IEC 61400-25; DNP3
Connection technology: Fieldbus input/output	2 x RJ-45
Baud rate	10/100 Mbit/s
Visualization	Web-Visu
Programming	WAGO-I/O-PRO V2.3 (based on CODESYS V2.3)
Type of memory card	SD and SDHC to 32 GB*
Program memory/data memory/non-volatile memory (software)	1024 KB / 1024 KB / 32 KB
Number of modules per node (max.)	250
Input and output process image (internal) max.	1020 words
Supply voltage (system)	24 VDC (-25 ... +30 %); via wiring level (CAGE CLAMP® connection)
Supply voltage (field)	24 VDC (-25 ... +30 %); via power jumper contacts
Input current (typ.) at nominal load (24 V)	500 mA
Current consumption – system supply (5 V)	450 mA
Total current (system supply)	1700 mA
Surrounding air temperature (operation)	0 ... +55 °C
Dimensions W x H x D	61.5 x 71.9 x 100 mm
Approvals	CE; Marine; OrdLoc/HazLoc; ATEX/IECEx
Data sheet and further information, see:	wago.com/750-880

Item No.	Page
758-879/000-001	470

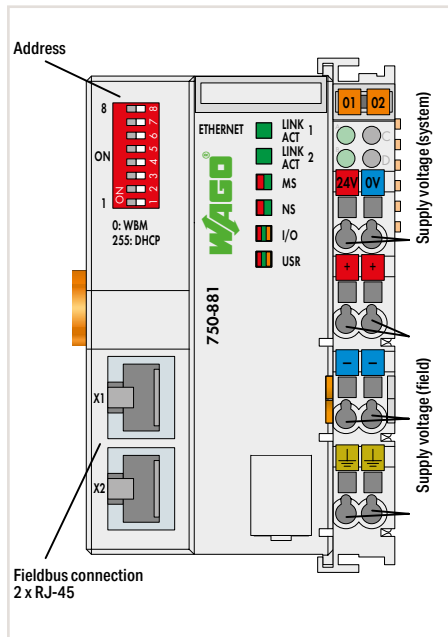
- „ WAGO-I/O-PRO V2.3 Software, see Section 2, page 32
- „ Approvals and corresponding ratings, see page 516 or www.wago.com

\*All guaranteed specifications are only valid with the WAGO memory card listed as an accessory.



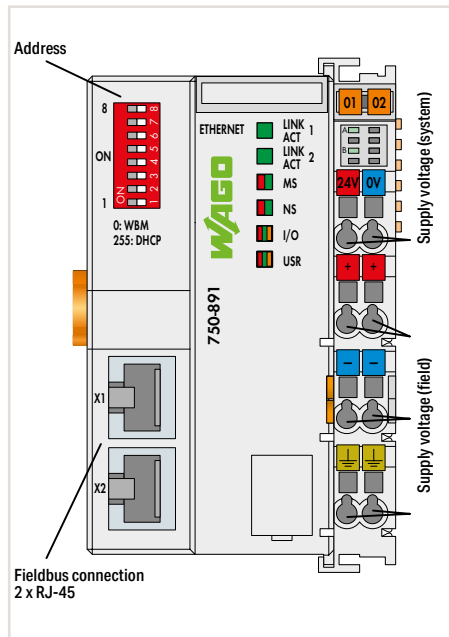
**Controller Modbus TCP; 4th generation; SD card slot**  
**Default**  
**750-890**

Controller Modbus TCP; G4; SD



**Controller ETHERNET; 3rd generation**  
**Default**  
**750-881**

Controller ETHERNET; G3



**Controller Modbus TCP; 4th generation**  
**Default**  
**750-891**

Controller Modbus TCP; G4

For new installations, please consider the 750-891 Controller with extended functionality.

Modbus (TCP, UDP)
HTTP(S); BootP; DHCP; DNS; SNTP; (S)FTP; SNMP
2 x RJ-45
10/100 Mbit/s
Web-Visu
WAGO-I/O-PRO V2.3 (based on CODESYS V2.3)
SD and SDHC to 32 GB*
8192 KB / 8192 KB / 32 KB
250
1020 words
24 VDC (-25 ... 30 %); via wiring level (CAGE CLAMP® connection)
24 VDC (-25 ... +30 %); via power jumper contacts
500 mA
440 mA
1700 mA
0 ... +55 °C
61.5 x 71.9 x 100 mm
CE; Marine; OrdLoc**/HazLoc; ATEX/IECEX
wago.com/750-890

EtherNet/IP; Modbus (TCP, UDP)
HTTP; BootP; DHCP; DNS; SNTP; FTP; SNMP
2 x RJ-45
10/100 Mbit/s
Web-Visu
WAGO-I/O-PRO V2.3 (based on CODESYS V2.3)
1024 KB / 512 KB / 32 KB
250
1020 words
24 VDC (-25 ... 30 %); via wiring level (CAGE CLAMP® connection)
24 VDC (-25 ... +30 %); via power jumper contacts
500 mA
450 mA
1700 mA
0 ... +55 °C
61.5 x 71.9 x 100 mm
CE; Marine; OrdLoc/HazLoc; ATEX/IECEX
wago.com/750-881

Modbus (TCP, UDP)
HTTP(S); BootP; DHCP; DNS; SNTP; (S)FTP; SNMP
2 x RJ-45
10/100 Mbit/s
Web-Visu
WAGO-I/O-PRO V2.3 (based on CODESYS V2.3)
4096 KB / 4096 KB / 32 KB
250
1020 words
24 VDC (-25 ... 30 %); via wiring level (CAGE CLAMP® connection)
24 VDC (-25 ... +30 %); via power jumper contacts
500 mA
390 mA
1700 mA
0 ... +55 °C
61.5 x 71.9 x 100 mm
CE; Marine; OrdLoc*/HazLoc; ATEX/IECEX
wago.com/750-891

<b>Item No.</b>	<b>Page</b>
758-879/000-001	470

\*Pending

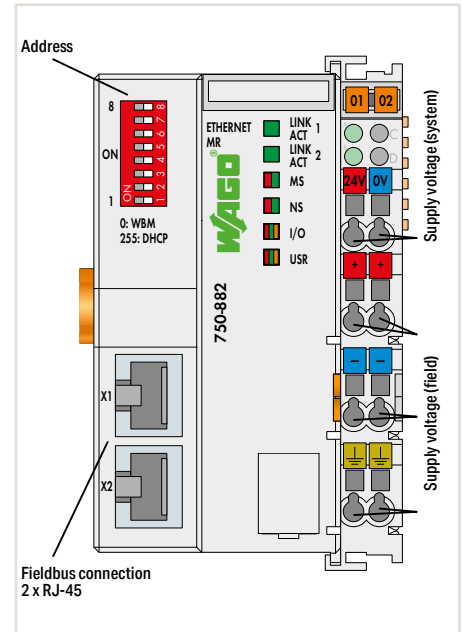
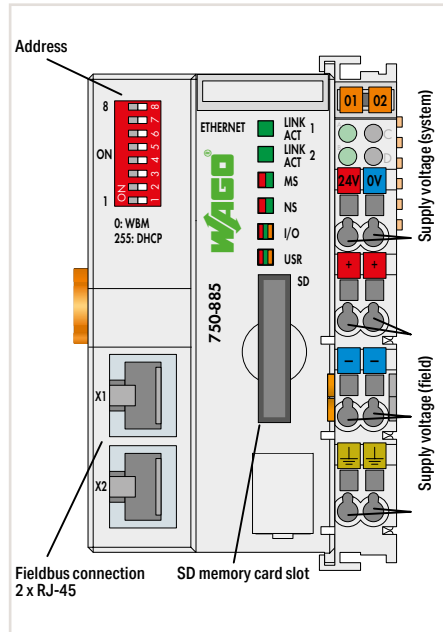
\*All guaranteed specifications are only valid with the WAGO memory card listed as an accessory.  
 \*\*Pending

## Controller ETHERNET; Media Redundancy



Figure: 750-885

Figure: 750-882



<b>Item description</b>
<b>Version</b>
<b>Item No.</b>
<b>Order text</b>

<b>Controller ETHERNET; 3rd generation; SD card slot; Media redundancy</b>	
<b>Default</b>	<b>Ext. temperature</b>
750-885	750-885/025-000
Controller ETHERNET; G3; SD; MR	Controller ETHERNET; G3; SD; MR; T

<b>Controller ETHERNET; 3rd generation; Media redundancy</b>	
<b>Default</b>	
750-882	
Controller ETHERNET; G3; MR	

<b>Technical Data</b>	
Communication	EtherNet/IP; Modbus (TCP, UDP)
ETHERNET protocols	HTTP; BootP; DHCP; DNS; SNTP; FTP; SNMP
Connection technology: Fieldbus input/output	2 x RJ-45
Baud rate	10/100 Mbit/s
Redundancy function	Application-based communication redundancy
Visualization	Web-Visu
Programming	WAGO-I/O-PRO V2.3 (based on CODESYS V2.3)
Type of memory card	SD and SDHC to 32 GB*
Program memory/data memory/non-volatile memory (software)	1024 KB / 1024 KB / 32 KB
Number of modules per node (max.)	250
Input and output process image (internal) max.	1020 words
Supply voltage (system)	24 VDC (-25 ... +30 %); via wiring level (CAGE CLAMP® connection)
Supply voltage (field)	24 VDC (-25 ... +30 %); via power jumper contacts
Input current (typ.) at nominal load (24 V)	500 mA
Current consumption – system supply (5 V)	450 mA
Total current (system supply)	1700 mA
Surrounding air temperature (operation)	0 ... +55 °C      -20 ... +60 °C
Dimensions W x H x D	61.5 x 71.9 x 100 mm
<b>Approvals</b>	CE; Marine; OrdLoc/HazLoc; ATEX/IECEx
<b>Data sheet and further information, see:</b>	<a href="http://wago.com/750-885">wago.com/750-885</a>

<b>Controller ETHERNET; 3rd generation; Media redundancy</b>	
EtherNet/IP; Modbus (TCP, UDP)	
HTTP; BootP; DHCP; DNS; SNTP; FTP; SNMP	
2 x RJ-45	
10/100 Mbit/s	
Application-based communication redundancy	
Web-Visu	
WAGO-I/O-PRO V2.3 (based on CODESYS V2.3)	
SD and SDHC to 32 GB*	
1024 KB / 512 KB / 32 KB	
250	
1020 words	
24 VDC (-25 ... +30 %); via wiring level (CAGE CLAMP® connection)	
24 VDC (-25 ... +30 %); via power jumper contacts	
500 mA	
450 mA	
1700 mA	
0 ... +55 °C      -20 ... +60 °C	
61.5 x 71.9 x 100 mm	
CE; Marine; OrdLoc/HazLoc; ATEX/IECEx	
<a href="http://wago.com/750-882">wago.com/750-882</a>	

<b>Controller ETHERNET; 3rd generation; Media redundancy</b>	
EtherNet/IP; Modbus (TCP, UDP)	
HTTP; BootP; DHCP; DNS; SNTP; FTP; SNMP	
2 x RJ-45	
10/100 Mbit/s	
Application-based communication redundancy	
Web-Visu	
WAGO-I/O-PRO V2.3 (based on CODESYS V2.3)	
SD and SDHC to 32 GB*	
1024 KB / 512 KB / 32 KB	
250	
1020 words	
24 VDC (-25 ... +30 %); via wiring level (CAGE CLAMP® connection)	
24 VDC (-25 ... +30 %); via power jumper contacts	
500 mA	
450 mA	
1700 mA	
0 ... +55 °C	
61.5 x 71.9 x 100 mm	
CE; Marine; OrdLoc/HazLoc; ATEX/IECEx	
<a href="http://wago.com/750-882">wago.com/750-882</a>	

<b>Accessories</b>
SD memory card; 2 GB

<b>Item No.</b>	<b>Page</b>
758-879/000-001	470

\*All guaranteed specifications are only valid with the WAGO memory card listed as an accessory.

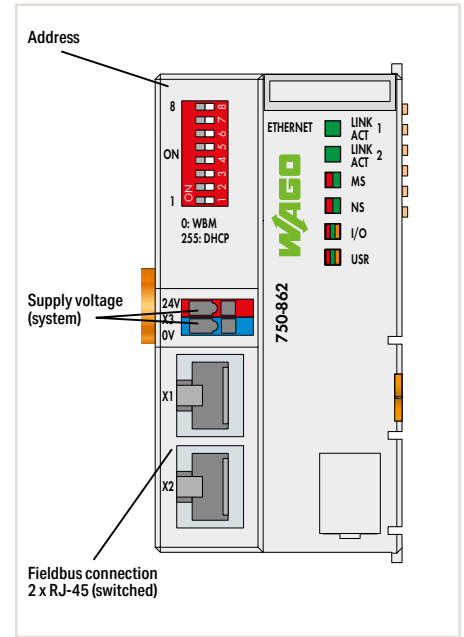
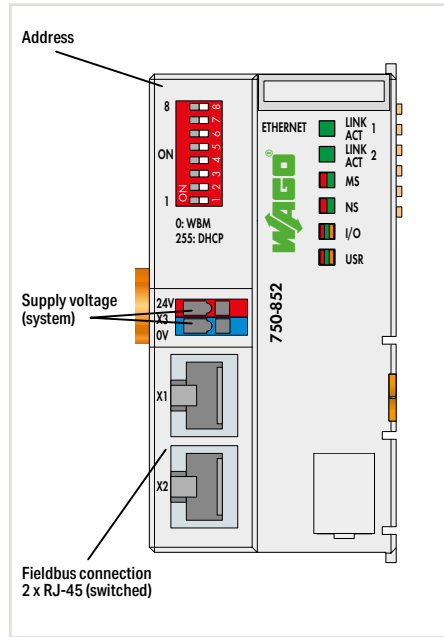
- „ WAGO-I/O-PRO V2.3 Software, see Section 2, page 32
- „ Mini-WSB marker card and mounting accessories, see Section "Accessories and Tools"
- „ Approvals and corresponding ratings, see page 516 or [www.wago.com](http://www.wago.com)



# Controller ETHERNET; Modbus TCP; Eco



Figure: 750-852



<b>Item description</b>
<b>Item No.</b>
<b>Order text</b>

<b>Controller ETHERNET; 3rd generation; Eco</b>
<b>750-852</b>
Controller ETHERNET; G3; Eco
For new installations, please consider the 750-862 Controller with extended functionality.

<b>Controller Modbus TCP; 4th generation; Eco</b>
<b>750-862</b>
Controller Modbus TCP; G4; Eco

<b>Technical Data</b>	
Communication	EtherNet/IP; Modbus (TCP, UDP)
ETHERNET protocols	HTTP; BootP; DHCP; DNS; SNTP; FTP
Connection technology: Fieldbus input/output	2 x RJ-45
Baud rate	10/100 Mbit/s
Programming	WAGO-I/O-PRO V2.3 (based on CODESYS V2.3)
Program memory/data memory/non-volatile memory (software)	512 KB / 256 KB / 8 KB
Number of modules per node (max.)	250
Input and output process image (internal) max.	1020 words
Supply voltage (system)	24 VDC (-25 ... +30 %), via wiring level
Input current (typ.) at nominal load (24 V)	300 mA
Current consumption – system supply (5 V)	400 mA
Total current (system supply)	700 mA
Surrounding air temperature (operation)	0 ... +55 °C
Dimensions W x H x D	49.5 x 71.9 x 96.8 mm
<b>Approvals</b>	CE; Marine; OrdLoc/HazLoc; ATEX/IECEX
<b>Data sheet and further information, see:</b>	<a href="http://wago.com/750-852">wago.com/750-852</a>

<b>Controller Modbus TCP; 4th generation; Eco</b>	
<b>750-862</b>	
Controller Modbus TCP; G4; Eco	
Communication	Modbus (TCP, UDP)
ETHERNET protocols	HTTP(S); BootP; DHCP; DNS; SNTP; (S)FTP; SNMP
Connection technology: Fieldbus input/output	2 x RJ-45
Baud rate	10/100 Mbit/s
Programming	WAGO-I/O-PRO V2.3 (based on CODESYS V2.3)
Program memory/data memory/non-volatile memory (software)	2048 KB / 2048 KB / 16 KB
Number of modules per node (max.)	250
Input and output process image (internal) max.	1020 words
Supply voltage (system)	24 VDC (-25 ... +30 %), via wiring level
Input current (typ.) at nominal load (24 V)	300 mA
Current consumption – system supply (5 V)	390 mA
Total current (system supply)	700 mA
Surrounding air temperature (operation)	0 ... +55 °C
Dimensions W x H x D	49.5 x 71.9 x 96.8 mm
<b>Approvals</b>	CE; Marine; OrdLoc*/HazLoc; ATEX/IECEX
<b>Data sheet and further information, see:</b>	<a href="http://wago.com/750-862">wago.com/750-862</a>

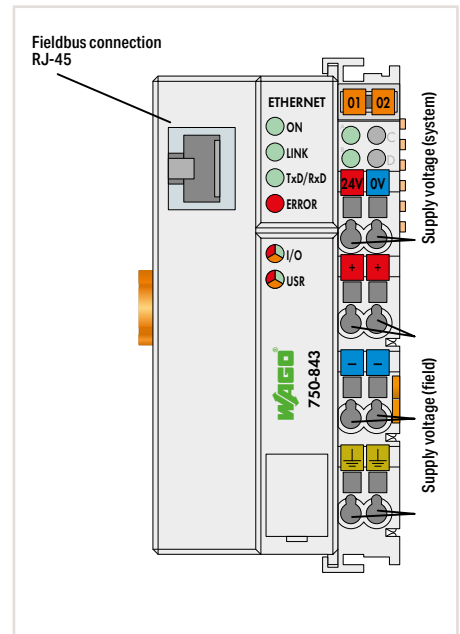
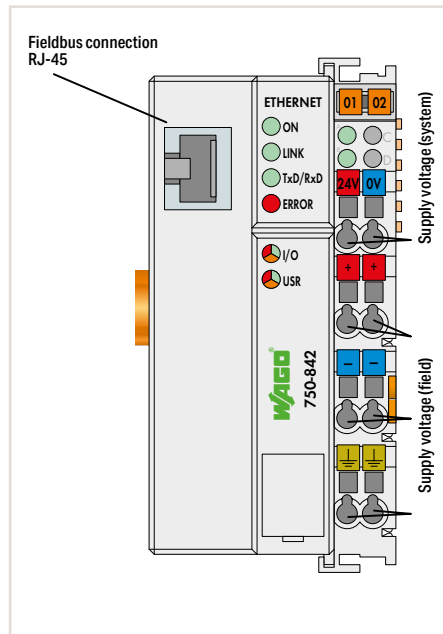
<b>Controller Modbus TCP; 4th generation; Eco</b>	
<b>750-862</b>	
Controller Modbus TCP; G4; Eco	
Communication	Modbus (TCP, UDP)
ETHERNET protocols	HTTP(S); BootP; DHCP; DNS; SNTP; (S)FTP; SNMP
Connection technology: Fieldbus input/output	2 x RJ-45
Baud rate	10/100 Mbit/s
Programming	WAGO-I/O-PRO V2.3 (based on CODESYS V2.3)
Program memory/data memory/non-volatile memory (software)	2048 KB / 2048 KB / 16 KB
Number of modules per node (max.)	250
Input and output process image (internal) max.	1020 words
Supply voltage (system)	24 VDC (-25 ... +30 %), via wiring level
Input current (typ.) at nominal load (24 V)	300 mA
Current consumption – system supply (5 V)	390 mA
Total current (system supply)	700 mA
Surrounding air temperature (operation)	0 ... +55 °C
Dimensions W x H x D	49.5 x 71.9 x 96.8 mm
<b>Approvals</b>	CE; Marine; OrdLoc*/HazLoc; ATEX/IECEX
<b>Data sheet and further information, see:</b>	<a href="http://wago.com/750-862">wago.com/750-862</a>

\*Pending

# Controller ETHERNET



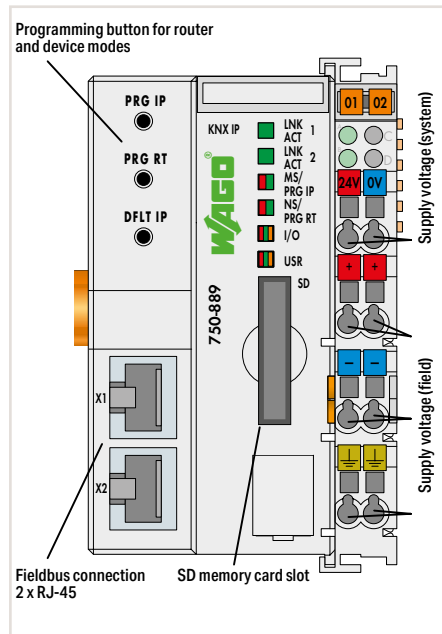
Figure: 750-842



Item description	Controller ETHERNET; 1st generation 750-842	Controller ETHERNET; 1st generation; Eco 750-843
Item No.	750-842	750-843
Order text	Controller ETHERNET; G1	Controller ETHERNET; G1; Eco
<b>Technical Data</b>		
Communication	Modbus (TCP, UDP)	Modbus (TCP, UDP)
ETHERNET protocols	HTTP; BootP	HTTP; BootP
Connection technology: Fieldbus input/output	RJ-45	RJ-45
Baud rate	10 Mbit/s	10 Mbit/s
Visualization	Without	Without
Programming	WAGO-I/O-PRO V2.3 (based on CODESYS V2.3)	WAGO-I/O-PRO V2.3 (based on CODESYS V2.3)
Program memory/data memory/non-volatile memory (software)	128 KB / 64 KB / 8 KB	64 KB / 64 KB / 8 KB
Number of modules per node (max.)	64	64
Input and output process image (internal) max.	512 bytes	512 bytes
Memory for fieldbus input and output variables (max.)	512 bytes	512 bytes
Supply voltage (system)	24 VDC (-25 ... +30 %); via wiring level (CAGE CLAMP® connection)	24 VDC (-25 ... +30 %); via wiring level (CAGE CLAMP® connection)
Supply voltage (field)	24 VDC (-25 ... +30 %); via power jumper contacts	24 VDC (-25 ... +30 %); via power jumper contacts
Input current (typ.) at nominal load (24 V)	500 mA	500 mA
Current consumption – system supply (5 V)	200 mA	200 mA
Total current (system supply)	1800 mA	1800 mA
Surrounding air temperature (operation)	0 ... +55 °C	0 ... +55 °C
Dimensions W x H x D	50.5 x 71.1 x 100 mm	50.5 x 71.1 x 100 mm
Approvals	CE; Marine; OrdLoc/HazLoc; ATEX/IECEX	CE; Marine; OrdLoc/HazLoc; ATEX/IECEX
Data sheet and further information, see:	<a href="http://wago.com/750-842">wago.com/750-842</a>	<a href="http://wago.com/750-843">wago.com/750-843</a>

„ WAGO-I/O-PRO V2.3 Software, see Section 2, page 32  
 „ Mini-WSB marker card and mounting accessories, see Section “Accessories and Tools”  
 „ Approvals and corresponding ratings, see page 516 or www.wago.com

## Controller KNX/IP



Item description	Controller KNX/IP
Item No.	750-889
Order text	Controller KNX/IP
<b>Technical Data</b>	
Communication	KNXnet/IP; Modbus (TCP, UDP)
ETHERNET protocols	HTTP; BootP; DHCP; DNS; AutoIP; SNTP; FTP; SNMP V3; SMTP
Connection technology: Fieldbus input/output	2 x RJ-45
Baud rate	10/100 Mbit/s
Visualization	Web-Visu
Programming	WAGO-I/O-PRO V2.3 (based on CODESYS V2.3)
Type of memory card	SD and SDHC to 32 GB*
KNX/TP1 bus specification	1.0
Number of group addresses	254
Number of communication objects	253
Program memory/data memory/non-volatile memory (software)	1024 KB / 1024 KB / 32 KB
Number of modules per node (max.)	250
Input and output process image (internal) max.	2 KB
Memory for fieldbus input and output variables (max.)	512 bytes
Supply voltage (system)	24 VDC (-25 ... +30 %); via wiring level (CAGE CLAMP® connection)
Supply voltage (field)	24 VDC (-25 ... +30 %); via power jumper contacts
Input current (typ.) at nominal load (24 V)	500 mA
Current consumption – system supply (5 V)	450 mA
Total current (system supply)	1700 mA
Surrounding air temperature (operation)	0 ... +55 °C
Dimensions W x H x D	61.5 x 71.9 x 100 mm
Approvals	CE; Marine; OrdLoc/HazLoc
KNX certified	IP Controller: 61/8316/08; IP Router: 61/8317/08
Data sheet and further information, see:	<a href="http://wago.com/750-889">wago.com/750-889</a>
<b>Accessories</b>	
SD memory card; 2 GB	Item No. 758-879/000-001 Page 470
WAGO ETS Plug-In	Download see Section 2

This controller can accommodate two KNX logic devices at the same time:

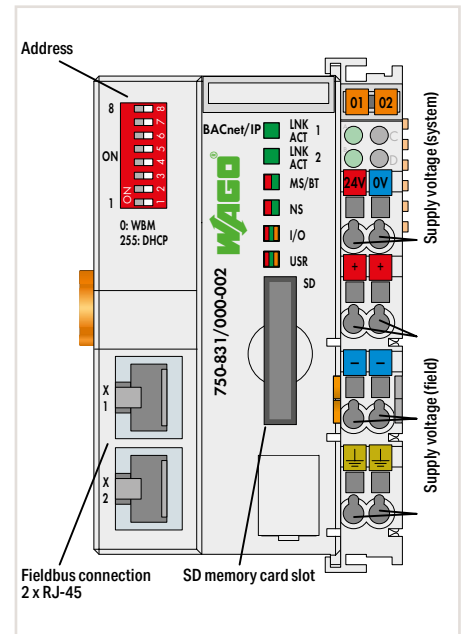
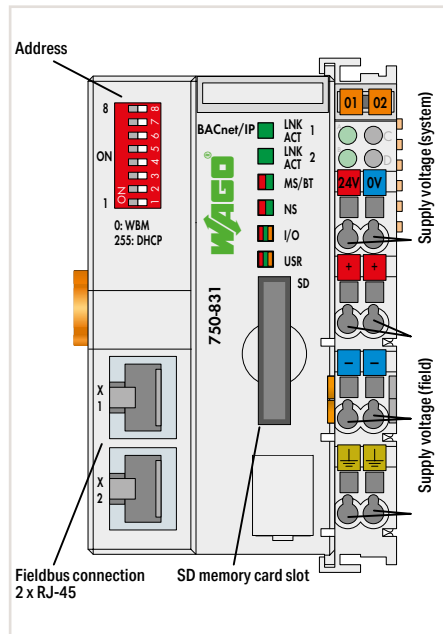
- Programmable controller
- KNX Router in connection with KNX/EIB/TP1 Module

Commissioning (KNX-side):  
via ETS plug-in, 2 programming buttons

# Controller BACnet/IP



Figure: 750-831



<b>Item description</b>
<b>Version</b>
<b>Item No.</b>
<b>Order text</b>

<b>Controller BACnet/IP</b>
<b>750-831</b>
Controller BACnet/IP

<b>Controller BACnet/IP</b>
<b>Eco</b>
<b>750-831/000-002</b>
Controller BACnet/IP; Eco

750-831/000-002 Controllers support a maximum of 256 BACnet objects.

<b>Technical Data</b>
Communication
ETHERNET protocols
Connection technology: Fieldbus input/output
Baud rate
Visualization
Programming
Type of memory card
BACnet device profile
BACnet revision
Program memory/data memory/non-volatile memory (software)
Number of modules per node (max.)
Input and output process image (internal) max.
Supply voltage (system)
Supply voltage (field)
Input current (typ.) at nominal load (24 V)
Current consumption – system supply (5 V)
Total current (system supply)
Surrounding air temperature (operation)
Dimensions W x H x D
<b>Approvals</b>
<b>BACnet approvals</b>

BACnet/IP; Modbus (TCP, UDP)
HTTP; BootP; DHCP; DNS; SNTP; FTP; SNMP
2 x RJ-45
10/100 Mbit/s
Web-Visu
WAGO-I/O-PRO V2.3 (based on CODESYS V2.3)
SD and SDHC to 32 GB*
B-BC (BACnet Building Controller)
1.7
1024 KB / 1024 KB / 28 KB
99
1020 words
24 VDC (-25 ... +30 %); via wiring level (CAGE CLAMP® connection)
24 VDC (-25 ... +30 %); via power jumper contacts
500 mA
450 mA
1700 mA
0 ... +55 °C
61.5 x 71.9 x 100 mm
CE; Marine; OrdLoc
WSPCert certification: ISO 16484-5:2012; BTL listing: BTL (BACnet® Testing Labs Product Listing) AMEV certificate: AMEV profile AS-A

BACnet/IP; Modbus (TCP, UDP)
HTTP; BootP; DHCP; DNS; SNTP; FTP; SNMP
2 x RJ-45
10/100 Mbit/s
Web-Visu
WAGO-I/O-PRO V2.3 (based on CODESYS V2.3)
SD and SDHC to 32 GB*
B-BC (BACnet Building Controller)
1.7
1024 KB / 1024 KB / 28 KB
99
1020 words
24 VDC (-25 ... +30 %); via wiring level (CAGE CLAMP® connection)
24 VDC (-25 ... +30 %); via power jumper contacts
500 mA
450 mA
1700 mA
0 ... +55 °C
61.5 x 71.9 x 100 mm
CE; Marine; OrdLoc

Data sheet and further information, see:

[wago.com/750-831](http://wago.com/750-831)

[wago.com/750-831/000-002](http://wago.com/750-831/000-002)

<b>Accessories</b>
SD memory card; 2 GB
BACnet Configurator

<b>Item No.</b>	<b>Page</b>
758-879/000-001	470
<b>Download</b>	see Section 2

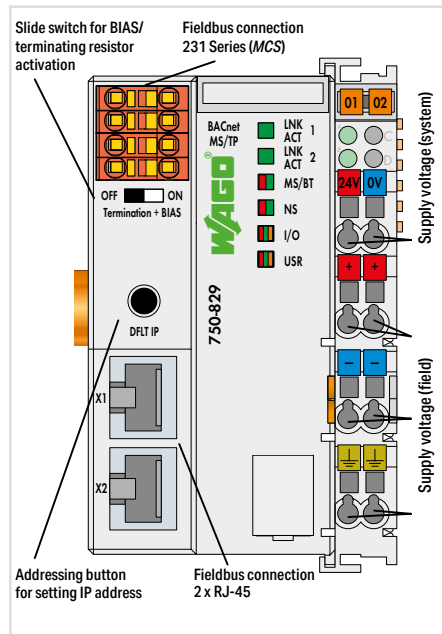
<b>Item No.</b>	<b>Page</b>
758-879/000-001	470
<b>Download</b>	see Section 2

\* WAGO-I/O-PRO V2.3 Software, see Section 2, page 32  
 \* Approvals and corresponding ratings, see page 516 or [www.wago.com](http://www.wago.com)

\*All guaranteed specifications are only valid with the WAGO memory card listed as an accessory.

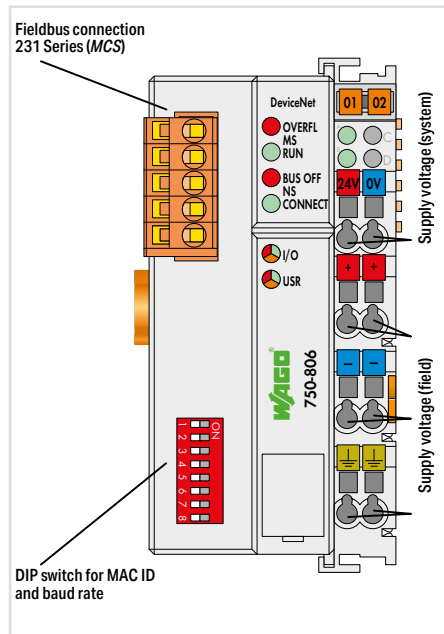
\*All guaranteed specifications are only valid with the WAGO memory card listed as an accessory.

## Controller BACnet MS/TP



Item description	Controller BACnet MS/TP				
Item No.	750-829				
Order text	Controller BACnet MS/TP				
<b>Technical Data</b>					
Communication	BACnet MS/TP; Modbus (TCP, UDP)				
ETHERNET protocols	HTTP; BootP; DHCP; DNS; SNTP; FTP; SNMP; SMTP				
Connection technology: Fieldbus input/output	4-pole male connector				
Baud rate	9600, 19200, 38400*, 57600, 76800, 115200 Bd (per BACnet standard); *Factory setting				
Connection technology: Fieldbus input/output (2)	2 x RJ-45				
Baud rate (2)	10/100 Mbit/s				
Visualization	Web-Visu				
Programming	WAGO-I/O-PRO V2.3 (based on CODESYS V2.3)				
BACnet device profile	B-BC (BACnet Building Controller)				
BACnet revision	1.7				
Program memory/data memory/non-volatile memory (software)	1024 KB / 1024 KB / 32 KB				
Number of modules per node (max.)	99				
Input and output process image (internal) max.	2 KB				
Memory for fieldbus input and output variables (max.)	512 bytes				
Supply voltage (system)	24 VDC (-25 ... +30 %); via wiring level (CAGE CLAMP® connection)				
Supply voltage (field)	24 VDC (-25 ... +30 %); via power jumper contacts				
Input current (typ.) at nominal load (24 V)	500 mA				
Current consumption – system supply (5 V)	450 mA				
Total current (system supply)	1700 mA				
Surrounding air temperature (operation)	0 ... +55 °C				
Dimensions W x H x D	61.5 x 71.9 x 100 mm				
Approvals	CE; UL; OrdLoc/HazLoc				
BACnet approvals	WSPCert certification: Pending BTL listing: Pending				
Data sheet and further information, see:	<a href="http://wago.com/750-829">wago.com/750-829</a>				
<b>Accessories</b>					
BACnet Configurator	<table border="1"> <thead> <tr> <th>Item No.</th> <th>Page</th> </tr> </thead> <tbody> <tr> <td>Download</td> <td>see Section 2</td> </tr> </tbody> </table>	Item No.	Page	Download	see Section 2
Item No.	Page				
Download	see Section 2				

## Controller DeviceNet



### Item description

Item No.

Order text

### Technical Data

Communication

Connection technology: Fieldbus input/output

Baud rate

Number of fieldbus nodes on master (max.)

Visualization

Programming

Program memory/data memory/non-volatile memory (software)

Number of modules per node (max.)

Input and output process image (internal) max.

Memory for fieldbus input and output variables (max.)

Supply voltage (system)

Supply voltage (field)

Input current (typ.) at nominal load (24 V)

Current consumption – system supply (5 V)

Input current via DeviceNet interface at 11 V

Total current (system supply)

Surrounding air temperature (operation)

Dimensions W x H x D

Approvals

Data sheet and further information, see:

### Controller DeviceNet

750-806

Controller DeviceNet

DeviceNet

5-pole male connector

125 kBd; 250 kBd; 500 kBd

64

Without

WAGO-I/O-PRO V2.3 (based on CODESYS V2.3)

128 KB / 64 KB / 8 KB

64

1024 bytes

512 bytes

24 VDC (-25 ... +30 %); via wiring level (CAGE CLAMP® connection)

24 VDC (-25 ... +30 %); via power jumper contacts

500 mA

350 mA

120 mA

1650 mA

0 ... +55 °C

50.5 x 71.1 x 100 mm

CE; Marine; OrdLoc/HazLoc;

ATEX/IECEX

wago.com/750-806

„ WAGO-I/O-PRO V2.3 Software, see Section 2, page 32

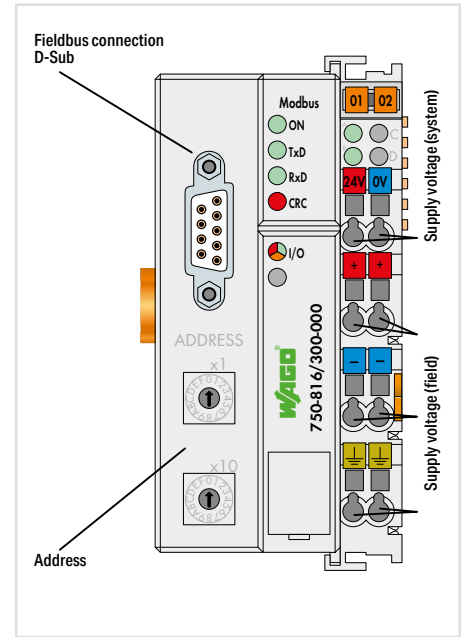
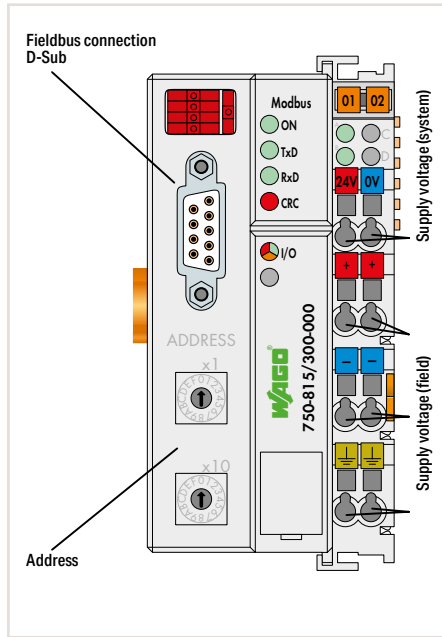
„ Mini-WSB marker card and mounting accessories, see Section "Accessories and Tools"

„ Approvals and corresponding ratings, see page 516 or www.wago.com

# Controller MODBUS



Figure: 750-815/300-000



<b>Item description</b>
<b>Version</b>
<b>Item No.</b>
<b>Order text</b>

<b>Controller MODBUS; RS-485; 115.2 kBd</b>	
<b>Default</b>	<b>Ext. temperature</b>
750-815/300-000	750-815/325-000
Controller MODBUS; RS-485; 115.2 kBd	Controller MODBUS; RS-485; 115.2 kBd; T

<b>Controller MODBUS; RS-232; 115.2 kBd</b>	
<b>Default</b>	
750-816/300-000	
Controller MODBUS; RS-232; 115.2 kBd	

<b>Technical Data</b>	
Communication	MODBUS
Connection technology: Fieldbus input/output	D-sub 9 socket
Baud rate	150 Bd ... 115.2 KBd
Number of fieldbus nodes on master (max.)	247
Visualization	Without
Programming	WAGO-I/O-PRO V2.3 (based on CODESYS V2.3)
Program memory/data memory/non-volatile memory (software)	32 KB / 32 KB / 8 KB
Number of modules per node (max.)	64
Input and output process image (internal) max.	1024 bytes
Memory for fieldbus input and output variables (max.)	512 bytes
Supply voltage (system)	24 VDC (-25 ... +30 %); via wiring level (CAGE CLAMP® connection)
Supply voltage (field)	24 VDC (-25 ... +30 %); via power jumper contacts
Input current (typ.) at nominal load (24 V)	500 mA
Current consumption – system supply (5 V)	350 mA
Total current (system supply)	1650 mA
Surrounding air temperature (operation)	0 ... +55 °C      -20 ... +60 °C
Dimensions W x H x D	50.5 x 71.1 x 100 mm
Approvals	CE; Marine; OrdLoc/HazLoc; ATEX/IECEx
Data sheet and further information, see:	wago.com/750-815/300-000

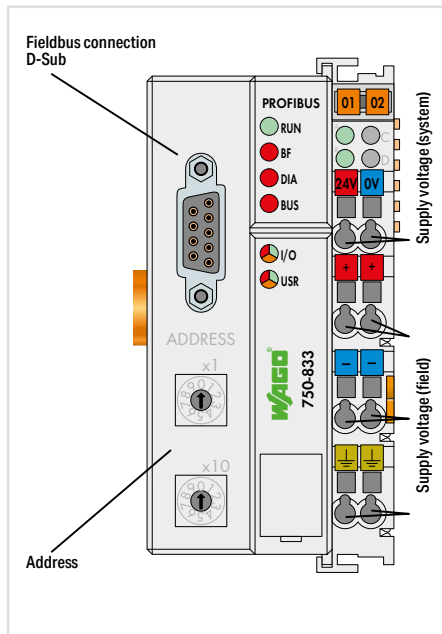
<b>MODBUS</b>	
D-sub 9 socket	
150 Bd ... 115.2 KBd	
247	
Without	
WAGO-I/O-PRO V2.3 (based on CODESYS V2.3)	
32 KB / 32 KB / 8 KB	
64	
1024 bytes	
512 bytes	
24 VDC (-25 ... +30 %); via wiring level (CAGE CLAMP® connection)	
24 VDC (-25 ... +30 %); via power jumper contacts	
500 mA	
350 mA	
1650 mA	
0 ... +55 °C      -20 ... +60 °C	
50.5 x 71.1 x 100 mm	
CE; Marine; OrdLoc/HazLoc; ATEX/IECEx	
wago.com/750-815/300-000	

<b>MODBUS</b>	
D-sub 9 socket	
150 Bd ... 115.2 KBd	
247	
Without	
WAGO-I/O-PRO V2.3 (based on CODESYS V2.3)	
32 KB / 32 KB / 8 KB	
64	
1024 bytes	
512 bytes	
24 VDC (-25 ... +30 %); via wiring level (CAGE CLAMP® connection)	
24 VDC (-25 ... +30 %); via power jumper contacts	
500 mA	
350 mA	
1650 mA	
0 ... +55 °C	
50.5 x 71.1 x 100 mm	
CE; Marine; OrdLoc/HazLoc; ATEX/IECEx	
wago.com/750-816/300-000	

# Controller PROFIBUS Slave



Figure: 750-833



<b>Item description</b>
<b>Version</b>
<b>Item No.</b>
<b>Order text</b>

<b>Controller PROFIBUS Slave</b>	
	<b>Ext. temperature</b>
750-833	750-833/025-000
Controller PROFIBUS Slave	Controller PROFIBUS Slave; T

<b>Technical Data</b>	
Communication	PROFIBUS
Connection technology: Fieldbus input/output	D-sub 9 socket
Baud rate	9.6 Kbd ... 12 MBd
Number of fieldbus nodes on master (max.)	99
Visualization	Without
Programming	WAGO-I/O-PRO V2.3 (based on CODESYS V2.3)
Program memory/data memory/non-volatile memory (software)	128 KB / 64 KB / 8 KB
Number of modules per node (max.)	63
Input and output process image (internal) max.	244 bytes
Memory for fieldbus input and output variables (max.)	244 bytes
Supply voltage (system)	24 VDC (-25 ... +30 %); via wiring level (CAGE CLAMP® connection)
Supply voltage (field)	24 VDC (-25 ... +30 %); via power jumper contacts
Input current (typ.) at nominal load (24 V)	500 mA
Current consumption – system supply (5 V)	200 mA
Total current (system supply)	1800 mA
Surrounding air temperature (operation)	0 ... +55 °C      -20 ... +60 °C
Dimensions W x H x D	50.5 x 71.1 x 100 mm
<b>Approvals</b>	CE; Marine; OrdLoc/HazLoc; ATEX/IECx
<b>Data sheet and further information, see:</b>	<a href="http://wago.com/750-833">wago.com/750-833</a>

<b>Technical Data</b>	
Communication	PROFIBUS
Connection technology: Fieldbus input/output	D-sub 9 socket
Baud rate	9.6 Kbd ... 12 MBd
Number of fieldbus nodes on master (max.)	99
Visualization	Without
Programming	WAGO-I/O-PRO V2.3 (based on CODESYS V2.3)
Program memory/data memory/non-volatile memory (software)	128 KB / 64 KB / 8 KB
Number of modules per node (max.)	63
Input and output process image (internal) max.	244 bytes
Memory for fieldbus input and output variables (max.)	244 bytes
Supply voltage (system)	24 VDC (-25 ... +30 %); via wiring level (CAGE CLAMP® connection)
Supply voltage (field)	24 VDC (-25 ... +30 %); via power jumper contacts
Input current (typ.) at nominal load (24 V)	500 mA
Current consumption – system supply (5 V)	200 mA
Total current (system supply)	1800 mA
Surrounding air temperature (operation)	0 ... +55 °C      -20 ... +60 °C
Dimensions W x H x D	50.5 x 71.1 x 100 mm
<b>Approvals</b>	CE; Marine; OrdLoc/HazLoc; ATEX/IECx
<b>Data sheet and further information, see:</b>	<a href="http://wago.com/750-833">wago.com/750-833</a>

- „ WAGO-I/O-PRO V2.3 Software, see Section 2, page 32
- „ Mini-WSB marker card and mounting accessories, see Section "Accessories and Tools"
- „ Approvals and corresponding ratings, see page 516 or [www.wago.com](http://www.wago.com)

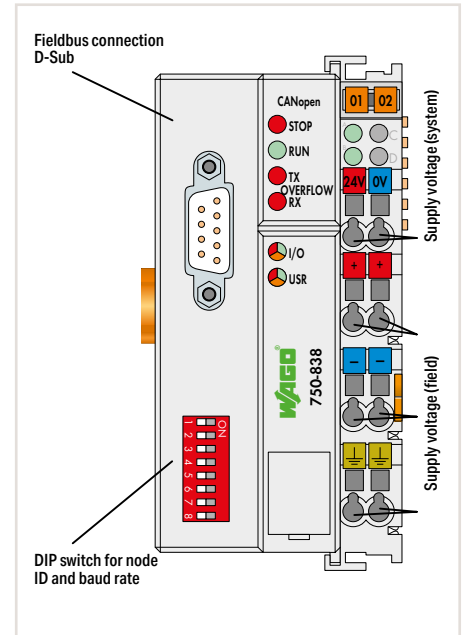
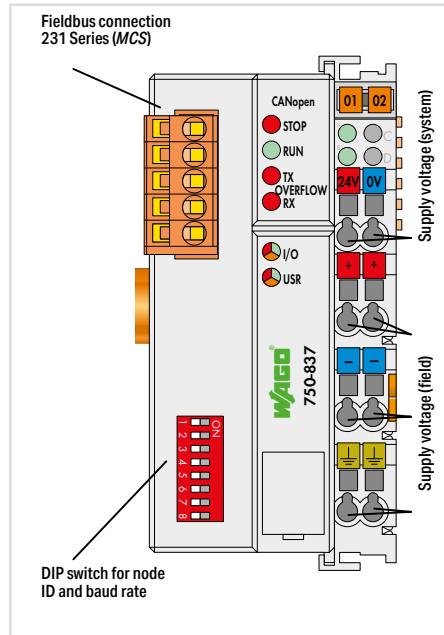


# Controller CANopen



Figure: 750-837

Figure: 750-838



<b>Item description</b>
<b>Version</b>
<b>Item No.</b>
<b>Order text</b>

<b>Controller CANopen; 128/64 KB Program/RAM; MCS</b>	
<b>Default</b>	<b>640/832 KB Program/RAM</b>
<b>750-837</b>	<b>750-837/021-000</b>
<b>Controller CANopen; M1; MCS</b>	<b>Controller CANopen; M3; MCS</b>

<b>Controller CANopen; 128/64 KB Program/RAM; D-Sub</b>	
<b>Default</b>	<b>640/832 KB Program/RAM</b>
<b>750-838</b>	<b>750-838/021-000</b>
<b>Controller CANopen; M1; D-Sub</b>	<b>Controller CANopen; M3; D-Sub</b>

<b>Technical Data</b>	
Communication	CANopen
Connection technology: Fieldbus input/output	5-pole male connector
Baud rate	10 Kbd ... 1 MBd
Number of fieldbus nodes on master (max.)	110
Visualization	Without
Programming	WAGO-I/O-PRO V2.3 (based on CODESYS V2.3)
Program memory	128 KB      640 KB
Data memory	64 KB      832 KB
Non-volatile memory (software)	8 KB
Number of modules per node (max.)	64
Input and output process image (internal) max.	512 bytes
Memory for fieldbus input and output variables (max.)	512 bytes
Communication profile	DS-301 V4.01
Device profile	DS-401 V2.0
Number of PDOs	32 Tx / 32 Rx
Number of SDOs	2 servers SDO / 16 clients SDO
Supply voltage (system)	24 VDC (-25 ... +30 %); via wiring level (CAGE CLAMP® connection)
Supply voltage (field)	24 VDC (-25 ... +30 %); via power jumper contacts
Input current (typ.) at nominal load (24 V)	500 mA
Current consumption – system supply (5 V)	500 mA
Total current (system supply)	1650 mA
Surrounding air temperature (operation)	0 ... +55 °C
Dimensions W x H x D	50.5 x 71.1 x 100 mm
<b>Approvals</b>	CE; Marine; OrdLoc/HazLoc; ATEX/IECEX
<b>Data sheet and further information, see:</b>	<a href="http://wago.com/750-837">wago.com/750-837</a>

<b>Controller CANopen; 128/64 KB Program/RAM; D-Sub</b>	
<b>Default</b>	<b>640/832 KB Program/RAM</b>
<b>750-838</b>	<b>750-838/021-000</b>
<b>Controller CANopen; M1; D-Sub</b>	<b>Controller CANopen; M3; D-Sub</b>
Communication	CANopen
Connection technology: Fieldbus input/output	D-Sub 9 connector
Baud rate	10 Kbd ... 1 MBd
Number of fieldbus nodes on master (max.)	110
Visualization	Without
Programming	WAGO-I/O-PRO V2.3 (based on CODESYS V2.3)
Program memory	128 KB      640 KB
Data memory	64 KB      832 KB
Non-volatile memory (software)	8 KB
Number of modules per node (max.)	64
Input and output process image (internal) max.	512 bytes
Memory for fieldbus input and output variables (max.)	512 bytes
Communication profile	DS-301 V4.01
Device profile	DS-401 V2.0
Number of PDOs	32 Tx / 32 Rx
Number of SDOs	2 servers SDO / 16 clients SDO
Supply voltage (system)	24 VDC (-25 ... +30 %); via wiring level (CAGE CLAMP® connection)
Supply voltage (field)	24 VDC (-25 ... +30 %); via power jumper contacts
Input current (typ.) at nominal load (24 V)	500 mA
Current consumption – system supply (5 V)	500 mA
Total current (system supply)	1650 mA
Surrounding air temperature (operation)	0 ... +55 °C
Dimensions W x H x D	50.5 x 71.1 x 100 mm
<b>Approvals</b>	CE; Marine; OrdLoc/HazLoc; ATEX/IECEX
<b>Data sheet and further information, see:</b>	<a href="http://wago.com/750-838">wago.com/750-838</a>



# Controllers 750 XTR

## Touch-Panel 600 Standard/Advanced Line; Hardware configuration Control Panel

- Merging of control and visualization
- 10.9 ... 25.7 cm (4.3 ... 10.1")

◀◀◀ Section 3

## Controllers PFC200 XTR

The advantages of the PFC Controller combined with the capabilities for extreme environments:

- High processing speed
- Multiple interfaces
- eXTRemely robust and maintenance-free

◀◀ Section 4.2

## Controllers 750 XTR

For demanding applications in which the following are critical:

- Extreme temperature stability
- Immunity to electromagnetic interference and impulse voltages
- Vibration and shock resistance

## Controllers PFC100/PFC200

- Maximum performance in a minimum space
- Also programmable in high-level languages based on Linux®
- Security packages with SSH and SSL/TLS
- Runtime system for CODESYS V2 (only PFC200) and V3

◀◀◀ Section 4.1

## Controllers 750

- Controllers for all prominent fieldbus systems
- Programmable to IEC 61131-3
- Combinable with the modules of the WAGO-I/O-SYS-TEM 750

◀ Section 4.3

## Starter Kits

To get you up and running quickly, we offer starter kits to suit the most diverse applications:

- With Controller PFC100
- With Controller PFC200
- With Controller 750 ETHERNET
- With Controller 750 KNX IP or BACnet/IP

Section 4.5 ▶

# Controllers 750 XTR

## Contents

	Page
General Product Information	122
Interfaces and Types	123
Item Number Key	123
Standards and Rated Conditions for Rail Applications (EN 50155)	123
Installation Instructions	124
Standards and Rated Conditions	125
Approvals	125



CPU	ETHERNET				Description	Item No.	
	Modbus (TCP, UDP)	EtherNet/IP	CANopen	Telecontrol Protocols: IEC 60870, IEC 61850/61400, DNP3			
32 bits	M/S	S			Controller ETHERNET; 3rd generation; SD card slot; extreme	750-880/040-000	126
32 bits	M/S	S		x	Controller ETHERNET; 3rd generation; SD card slot; Telecontrol technology; extreme	750-880/040-001	126
32 bits			M/S		Controller CANopen; 640/832 KB Program/RAM; D-Sub; extreme	750-838/040-000	127

M: Master, S: Slave

## Controllers 750 XTR

### General Product Information

#### Controllers 750 XTR: From Standard to eXTReme — Standard for 750 XTR

The Controllers 750 XTR are easily recognized by their dark gray housings. Take advantage of the WAGO-I/O-SYSTEM 750 XTR's unique features, which make it ideal for extreme environments or applications.

Extremely temperature-resistant, immune to interference, as well as unfazed by vibrations and impulse voltages – these are impressive features of the WAGO-I/O-SYSTEM 750 XTR. WAGO's 750 XTR is the first choice for demanding applications including:

- Marine systems and onshore/offshore installations
- Renewable energy systems (wind turbines, solar systems and biogas plants)
- Transformer stations and power distribution systems
- Petrochemical processing
- Water and wastewater treatment systems
- Custom machines
- Railway applications

#### Marine Systems and Onshore/Offshore Industry

International approvals coupled with industry-specific features permit use in shipbuilding and other harsh sectors. Addressing requirements inherent in specific industries and operating environments has enabled use on marine diesels and in the EMC-sensitive area of a vessel's bridge. Because the requirements are significantly greater for immunity to interference or emission of interference, along with superior mechanical performance in these sensitive areas, the WAGO-I/O-SYSTEM can readily meet the needs of other industries.

#### Telecontrol Technology

Standardized Telecontrol protocols according to IEC 60870-5, IEC 61850 or IEC 61400-25 and DNP3 ensure use of the Controllers 750 XTR in telecontrol technology. They also meet increased impulse-voltage withstand requirements per EN 60870-2-1.

The result is a tailor-made solution for demanding telecontrol applications that readily meets all requirements.

#### Link between Process Data and IT Application — Even under eXTReme Conditions

The controllers ideally combine real-time requirements with IT functionality. They support Modbus/TCP and EtherNet/IP for use in industrial environments. HTTP, SNMP, FTP, BootP, DHCP, DNS and other protocols simplify integration into IT environments. Integrated Web pages and Web-based visualization provide IT applications with real-time process data. Furthermore, the 750 Series Controllers incorporate library functions for email, SOAP, ASP, IP configuration, ETHERNET sockets and file system.

#### Modular and Expandable

With the WAGO-I/O-SYSTEM 750 XTR, the controllers can be expanded to almost any input/output interface. Using an industry-leading platform, the 750 XTR boasts the same proven benefits.

#### Worldwide Approvals

International approvals for industrial automation, building technology, shipbuilding and onshore/offshore applications guarantee worldwide use – even under harsh operating conditions, e.g., Germanischer Lloyd, Det Norske Veritas, American Bureau of Shipping, Korean Register of Shipping, Nippon Kaiji Kyokai, Registro Italiano Navale and Polski Rejestr Stratkow.



#### Superior Reliability in Extreme Climates

Engineered for freezing cold, extreme heat and high humidity, the WAGO-I/O-SYSTEM 750 XTR provides absolute dependability in virtually any weather. The XTR version of the 750 Series Controllers is unfazed by both freezing cold down to  $-40^{\circ}\text{C}$  and scorching heat up to  $+70^{\circ}\text{C}$ . And this applies equally for both start-up and ongoing operation. The maximum approved operating altitude of 5,000 m is another highlight. Even in the thin air of a mountain-top station, the system impressively demonstrates its high performance and availability.

#### Additional Protection Against Interference Pulses

The WAGO-I/O-SYSTEM 750 XTR provides greater isolation up to 5 kV of impulse voltage, lower EMC emission of interference and higher insensitivity to EMC interference. These strengths add up to trouble-free operation.

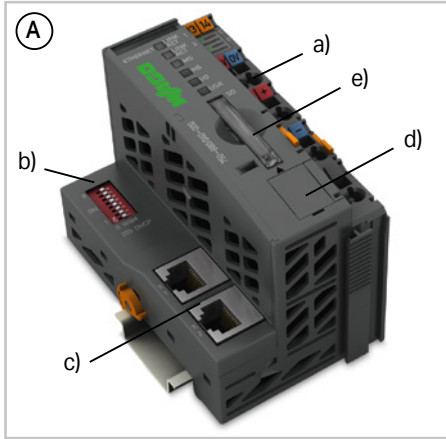
#### High Mechanical Performance

Automation systems must be incredibly vibration-resistant, especially when installed close to vibration-prone and shock-generating system components. Powerful motors and power circuit breakers are just two examples from a wide range of applications that can stress automation systems. The WAGO-I/O-SYSTEM 750 XTR continues to set new standards here. Count on long-lasting, trouble-free operation and industry-topping levels of safety – even in the most severe applications, such as tunnel boring machines.

#### Advantages:

- Controllers for eXTReme environmental conditions
  - No air conditioning required
  - Can be used in unshielded areas
  - Install close to vibrating and shock-generating system components
- Extensive IT integration possibilities
- Expandable with the WAGO-I/O-SYSTEM 750 XTR's comprehensive product range
- Maintenance-free
- Vibration-proof, fast and maintenance-free CAGE CLAMP® spring connections

# Controllers 750 XTR Interfaces and Types



- Including supply module to power down-stream I/O modules (a)
- Technical differences on the connection level; addressing switch (b) and fieldbus interface (c)
- Service interface (d)

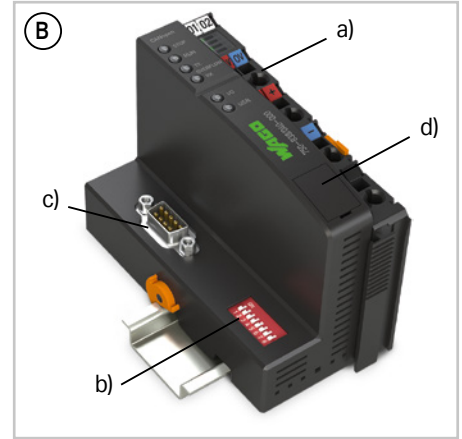
### Housing design (A)

- SD card slot for external storage media (e)
- W x H x D (mm) 61.5 x 71.9 x 100

### Housing design Eco (B)

- W x H x D (mm) 50.5 x 71.1 x 100

\*Height from upper edge of DIN-rail



## Item Number Key

Explanation of the components of an item number key

Item No.: 750-8xx/040-00y		
3x: 16-bit	CANopen	
8x: 32-bit multitasking 001:	ETHERNET Telecontrol Technology	

## Standards and Rated Conditions for Rail Applications (EN 50155)

Railway Applications (EN 50155)	Class/Standard Compliance
<b>4.1 Rated operating conditions</b>	
4.1.1 Altitude above sea level	AX (EN 50125-1)
4.1.2 Surrounding air temperature	TX
4.1.3 Shock and vibration	1A and 1B (EN 61373)
4.1.4 Relative humidity	95 % (coated PCBs)
<b>5.1 Power supply</b>	
5.1.1.1 Master voltage fluctuations	
Minimum voltage	0.725 x Un
Maximum voltage	1.3 x Un
5.1.1.2 Power interruptions	S1
<b>5.4 Surge, ESD, burst tests</b>	EN 50121-3-2
<b>5.5 EMC (emission of interference, immunity to interference)</b>	EN 50121-3-2, EN 50121-4, -5
<b>Fire behavior: per EN 45545-2 hazard level HL3</b>	
WAGO is certified in accordance with the IRIS quality standard.	

# Controllers 750 XTR Installation Instructions

## Power Supply

The internal electronics are powered by the controller. The power supply to the field-side supply is electrically isolated. The division enables a separate supply for sensors and actuators. Snapping the I/O modules together automatically routes the supply voltages. Supply modules with diagnostics enable additional monitoring of the power supply. This ensures a flexible, user-specific supply design for a station.

The current supply to the electronics is limited by a maximum value. This value is dependent on the controller used. If the sum of the internal current demand of all the I/O modules should exceed this value, an additional system supply module is necessary. Even in this case, power supply to the field-side supply of 10 A may not be exceeded. However, different power supply modules allow a new power supply, formation of potential groups and the implementation of emergency stops.

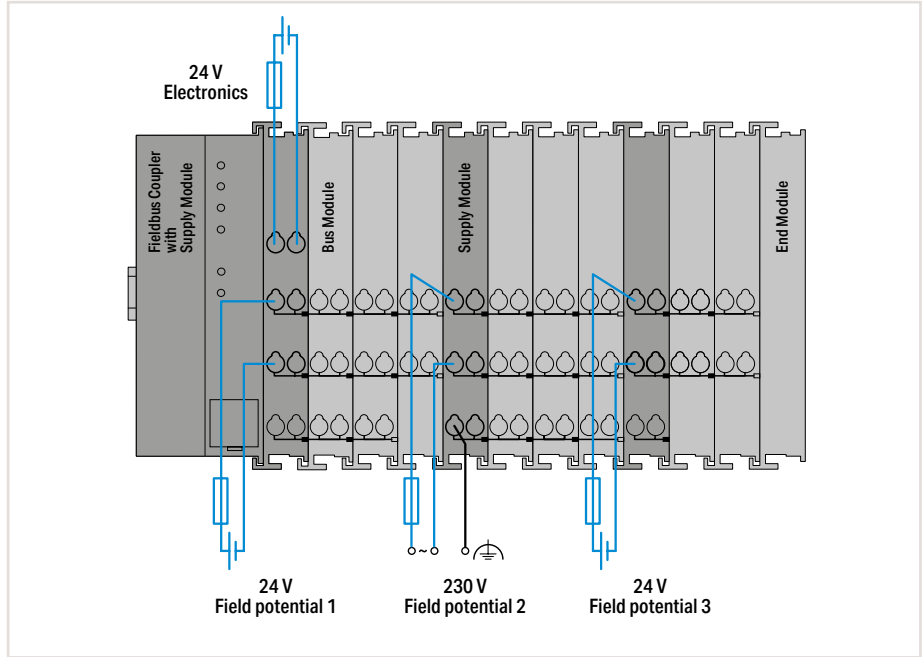
## Interference-Free in Safety-Related Applications

To easily and safely perform cost-effective, centralized deactivation of complete actuator groups, the actuator's power supply can be switched off using a safety switching device. This can either be performed for each individual actuator or by turning off the power supply to a group of control outputs. In the event of failure, ensure that no interference from other current or power circuits occurs – even when the control voltage is switched off – so the defined safety function properties (logic and time response) remain unchanged.

All 750 XTR Series Digital Output Modules provide interference-free safety functionality. The modules can be used in safety applications up to category 4 per DIN EN ISO 13849-1:2007. Safety category and performance level depend solely on the safety components and their wiring.

### Notice:

WAGO's interference-free I/O modules have no active influence on the safety function, they are not an active part of the safety application and are not a substitute for the safety switching device! When using the components in safety functions, the corresponding notes must be observed in the relevant manual.



## Notes

Additional steps must be implemented based on where the I/O system is installed:

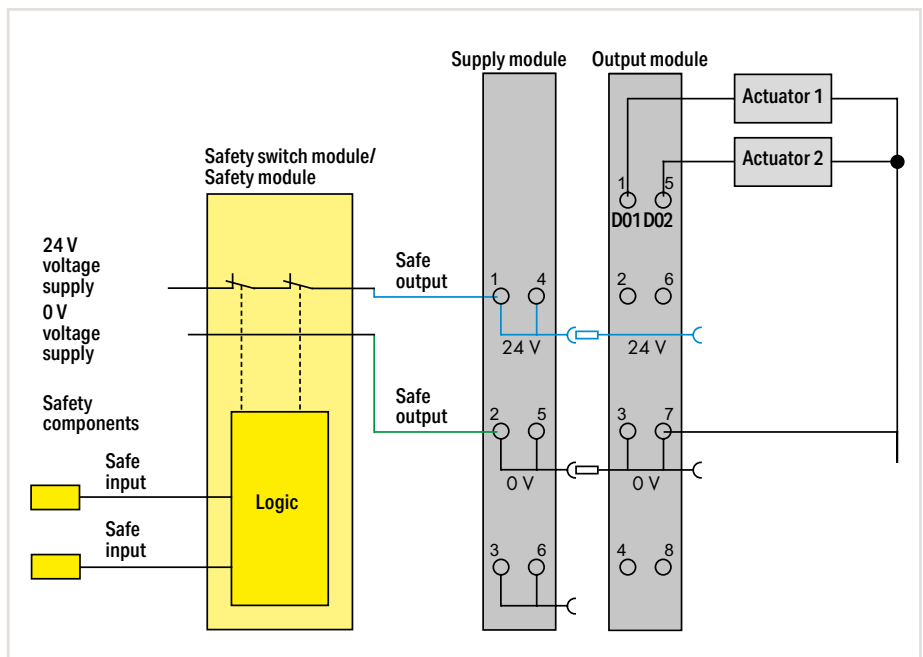
Specific power and field-side power supply filters (750-624/040-001 or 750-626/040-000) are required for marine and onshore/offshore applications, as well as in telecontrol and rail technology.

Please refer to the manual for details about the power supply's design.

## Mixed Operation

Mixed operation (standard/XTR modules) within a node is possible when groups of I/O modules are electrically isolated on the field side, i.e., electrically isolated power supply. The combination may be useful, for example, when there are only increased requirements for dielectric strength and immunity to interference, but the surrounding air temperature is not critical.

4.4



## Controllers 750 XTR

### Standards and Rated Conditions

General Specifications	
Supply voltage (system)	24 VDC (-25 ... +30 %); via wiring level (CAGE CLAMP® connection); Specified values for surrounding air temperature: +15 ... +35 °C For -40 ... +55 °C: 24 V (-25 ... +20 %); For +55 ... +70 °C: 24 V (-25 ... +10 %); Lower limit in all temperature ranges: -27.5 % (including 15 % residual ripple)
Surrounding air temperature (operation)	-40 ... +70 °C
Surrounding air temperature (storage)	-40 ... +85 °C
Relative humidity	Max. 95 %; Short-term condensation per Class 3K7 / IEC EN 60721-3-3 and E DIN 40046-721-3 (except wind-driven precipitation, water and ice formation)
Operating altitude	Without temperature derating: 0 ... 2000 m; With temperature derating: 2000 ... 5000 m (0.5 K/100 m); max.: 5000 m
Pollution degree	2 per IEC 61131-2
Immunity to impulse voltages	Per EN 60870-2-1 510 VAC/775 VDC Isolation: rated surge voltage (EN 60079-11) 1 kV (Class VW1 per EN 60870-2-1) Surge: 1 kV (L - L) / 2 kV (L - E)
Vibration resistance	Per IEC 60068-2-6 (acceleration: 5g); EN 60870-2-2; IEC 60721-3-1, -3; EN 50155; EN 61373
Shock resistance	Per IEC 60068-2-27 (15g/11 ms/half-sine/1,000 shocks; 25g/6 ms/1,000 shocks); EN 50155; EN 61373
EMC immunity to interference	Per EN 61000-6-1, -2; EN 61131-2; Marine applications; EN 50121-3-2; EN 50121-4, -5; EN 60255-26; EN 60870-2-1; EN 61850-3; IEC 61000-6-5; IEEE 1613; VDEW: 1994
EMC emission of interference	Per EN 61000-6-3, -4; EN 61131-2; EN 60255-26; Marine applications; EN 60870-2-1 (industrial and residential areas); EN 61850-3 (industrial and residential areas); EN 50121-3-2; EN 50121-4, -5
Protection type	IP20
Mounting position	Horizontal (standing/lying) or vertical
Mounting type	DIN-35 rail mounting
Housing material	Polycarbonate; polyamid 6.6
Exposure to pollutants	Per IEC 60068-2-42 and IEC 60068-2-43
Permissible SO <sub>2</sub> contaminant concentration at a relative humidity < 75 %	25 ppm
Permissible H <sub>2</sub> S contaminant concentration at a relative humidity < 75 %	10 ppm
Connection technology	CAGE CLAMP®
Conductor cross sections; Strip length	0.25 ... 2.5 mm <sup>2</sup> /AWG 24 ... 14; 8 ... 9 mm / 0.31 ... 0.35 inch
Current carrying capacity (power jumper contacts)	10 A

4.4

## Approvals

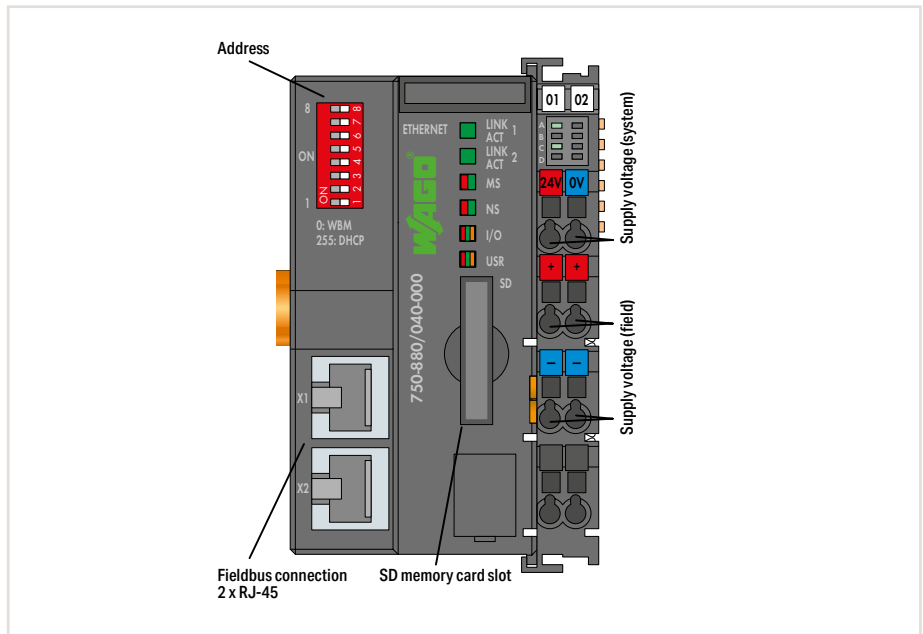
Overview of the approvals in the article comparison in Section 11, Technical Appendix, or online at [www.wago.com](http://www.wago.com)



# Controller ETHERNET



Figure: 750-880/040-000



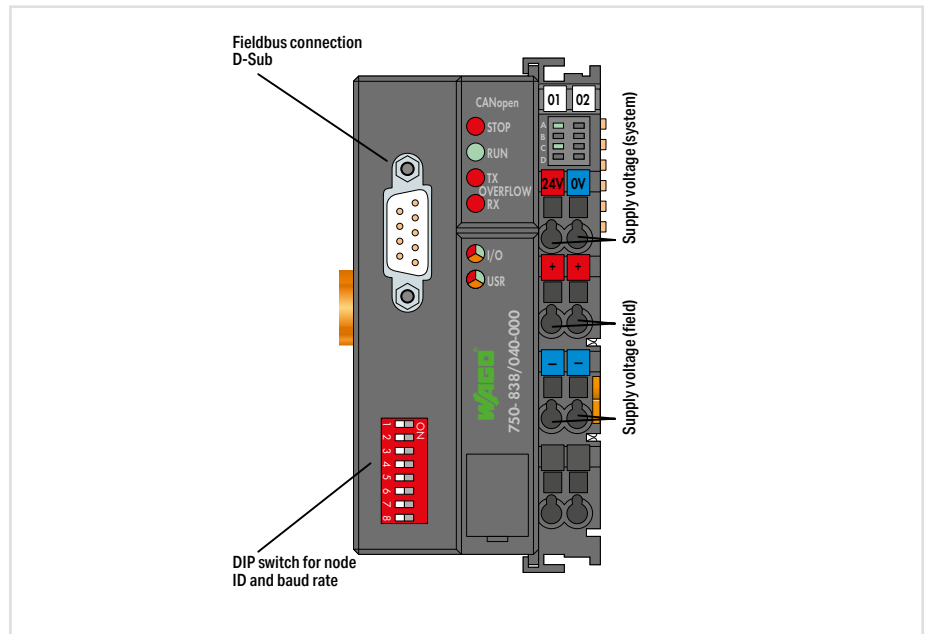
<b>Item description</b>		<b>Controller ETHERNET; 3rd generation; SD card slot</b>	
<b>Version</b>	<b>Extreme</b>	<b>Telecontrol technology; extreme</b>	
<b>Item No.</b>	<b>750-880/040-000</b>	<b>750-880/040-001</b>	
<b>Order text</b>	Controller ETHERNET; G3; SD; XTR	Controller ETHERNET; G3; SD; Tele; XTR	
<b>Technical Data</b>			
Communication	EtherNet/IP; Modbus (TCP, UDP)	EtherNet/IP; Modbus (TCP, UDP); Telecontrol protocols	
ETHERNET protocols	HTTP; BootP; DHCP; DNS; SNTP; FTP; SNMP		
Telecontrol protocols	IEC 60870-5-101/-103/-104; IEC 61850-7; IEC 61400-25; DNP3		
Connection technology: Fieldbus input/output	2 x RJ-45		
Baud rate	10/100 Mbit/s		
Visualization	Web-Visu		
Programming	WAGO-I/O-PRO V2.3 (based on CODESYS V2.3)		
Type of memory card	SD and SDHC to 32 GB*		
Program memory/data memory/non-volatile memory (software)	1024 KB / 1024 KB / 32 KB		
Number of modules per node (max.)	64		
Input and output process image (internal) max.	1020 words		
Supply voltage (system)	24 VDC (-25 ... +30 %); via wiring level (CAGE CLAMP® connection); Specified values for surrounding air temperature: +15 ... +35 °C; For -40 ... +55 °C: 24 V (-25 ... +20 %); For +55 ... +70 °C: 24 V (-25 ... +10 %); Lower limit in all temperature ranges: -27.5 % (including 15 % residual ripple)		
Supply voltage (field)	24 VDC; via power jumper contacts		
Input current (typ.) at nominal load (24 V)	500 mA		
Current consumption – system supply (5 V)	450 mA		
Total current (system supply)	1700 mA (surrounding air (operating) temperature < 60 °C), 1500 mA (surrounding air (operating) temperature: 60 ... 70 °C)		
Surrounding air temperature (operation)	-40 ... +70 °C		
Dimensions W x H x D	61.5 x 71.9 x 100 mm		
<b>Approvals</b>	CE; Marine; OrdLoc/HazLoc; ATEX/IECEX		
<b>Data sheet and further information, see:</b>	<a href="http://wago.com/750-880/040-000">wago.com/750-880/040-000</a>	<a href="http://wago.com/750-880/040-001">wago.com/750-880/040-001</a>	
<b>Accessories</b>		<b>Item No.</b>	<b>Page</b>
SD memory card; 2 GB		<b>758-879/000-001</b>	470

\*All guaranteed specifications are only valid with the WAGO memory card listed as an accessory.

- „ WAGO-I/O-PRO V2.3 Software, see Section 2, page 32
- „ Mini-WSB marker card and mounting accessories, see Section "Accessories and Tools"
- „ Approvals and corresponding ratings, see page 516 or [www.wago.com](http://www.wago.com)



## Controller CANopen



<b>Item description</b>	<b>Controller CANopen; 640/832 KB Program/RAM; D-Sub</b>
<b>Version</b>	<b>Extreme</b>
<b>Item No.</b>	<b>750-838/040-000</b>
<b>Order text</b>	Controller CANopen; M3; DSub; XTR
<b>Technical Data</b>	
Communication	CANopen
Connection technology: Fieldbus input/output	D-Sub 9 connector
Bus segment length (max.)	1000 m
Baud rate	10 Kbd ... 1 MBd
Number of fieldbus nodes on master (max.)	110
Visualization	Without
Programming	WAGO-I/O-PRO V2.3 (based on CODESYS V2.3)
Program memory/data memory/non-volatile memory (software)	640 KB / 832 KB / 8 KB
Number of modules per node (max.)	64
Input and output process image (internal) max.	512 bytes
Memory for fieldbus input and output variables (max.)	512 bytes
Communication profile	DS-301 V4.01
Device profile	DS-401 V2.0
Number of PDOs	32 Tx / 32 Rx
Number of SDOs	2 servers SDO / 16 clients SDO
Supply voltage (system)	24 VDC (-25 ... +30 %); via wiring level (CAGE CLAMP® connection); Specified values for surrounding air temperature: +15 ... +35 °C; For -40 ... +55 °C: 24 V (-25 ... +20 %); For +55 ... +70 °C: 24 V (-25 ... +10 %); Lower limit in all temperature ranges: -27.5 % (including 15 % residual ripple)
Supply voltage (field)	24 VDC; via power jumper contacts
Input current (typ.) at nominal load (24 V)	500 mA
Current consumption – system supply (5 V)	350 mA
Total current (system supply)	1650 mA (surrounding air (operating) temperature < 60 °C), 1250 mA (surrounding air (operating) temperature: 60 ... 70 °C)
Surrounding air temperature (operation)	-40 ... +70 °C
Dimensions W x H x D	50.5 x 71.1 x 100 mm
<b>Approvals</b>	CE; Marine; OrdLoc/HazLoc; ATEX/IECEX
<b>Data sheet and further information, see:</b>	<a href="http://wago.com/750-838/040-000">wago.com/750-838/040-000</a>



# Starter Kits

## Controllers PFC100/PFC200

- Maximum performance in a minimum space
- Also programmable in high-level languages based on Linux®
- Security packages with SSH and SSL/TLS
- Runtime system for CODESYS V2 (only PFC200) and V3

◀◀◀ Section 4.1

## Controllers 750

- Controllers for all prominent fieldbus systems
- Programmable to IEC 61131-3
- Combinable with the modules of the WAGO-I/O-SYSTEM 750

◀◀ Section 4.3

## I/O System – 750 and 753 Series

- Highly versatile
- More than 500 modules available
- Functional safety
- Ex i

Section 5 ▶






## Starter Kits

To get you up and running quickly, we offer starter kits to suit the most diverse applications:

- With Controller PFC100
- With Controller PFC200
- With Controller 750 ETHERNET
- With Controller 750 KNX IP or BACnet/IP

# WAGO Starter Kits Contents

Page

	Modbus (TCP, UDP)	EtherNet/IP	BACnet/IP	KNX IP	Description	Item No.	
	M/S	S			Starter Kit; e!COCKPIT with Controller PFC100; 2 x ETHERNET; Eco	8003-099/750-8100	130
	M/S	S			Starter Kit; Linux® with Controller PFC200; 2nd generation; 2 x ETHERNET, RS-232/-485	807-099/750-8212	131
	M/S	S			Starter Kit; ETHERNET 880 with Controller ETHERNET; 3rd generation; SD card slot	8003-001/K999-9999/000-1700	132
					Starter Kit; ETHERNET 881 with Controller ETHERNET; 3rd generation	8003-001/K999-9999/000-1600	133
	M/S		x		Starter Kit; BACnet/IP with Controller BACnet/IP; Eco	8003-099/750-831	134
	M/S			x	Starter Kit; KNX IP with Controller KNX IP	8003-001/K999-9999/000-901	135

M: Master, S: Slave

## Starter Kit; e!COCKPIT with Controller PFC100; 2 x ETHERNET; Eco



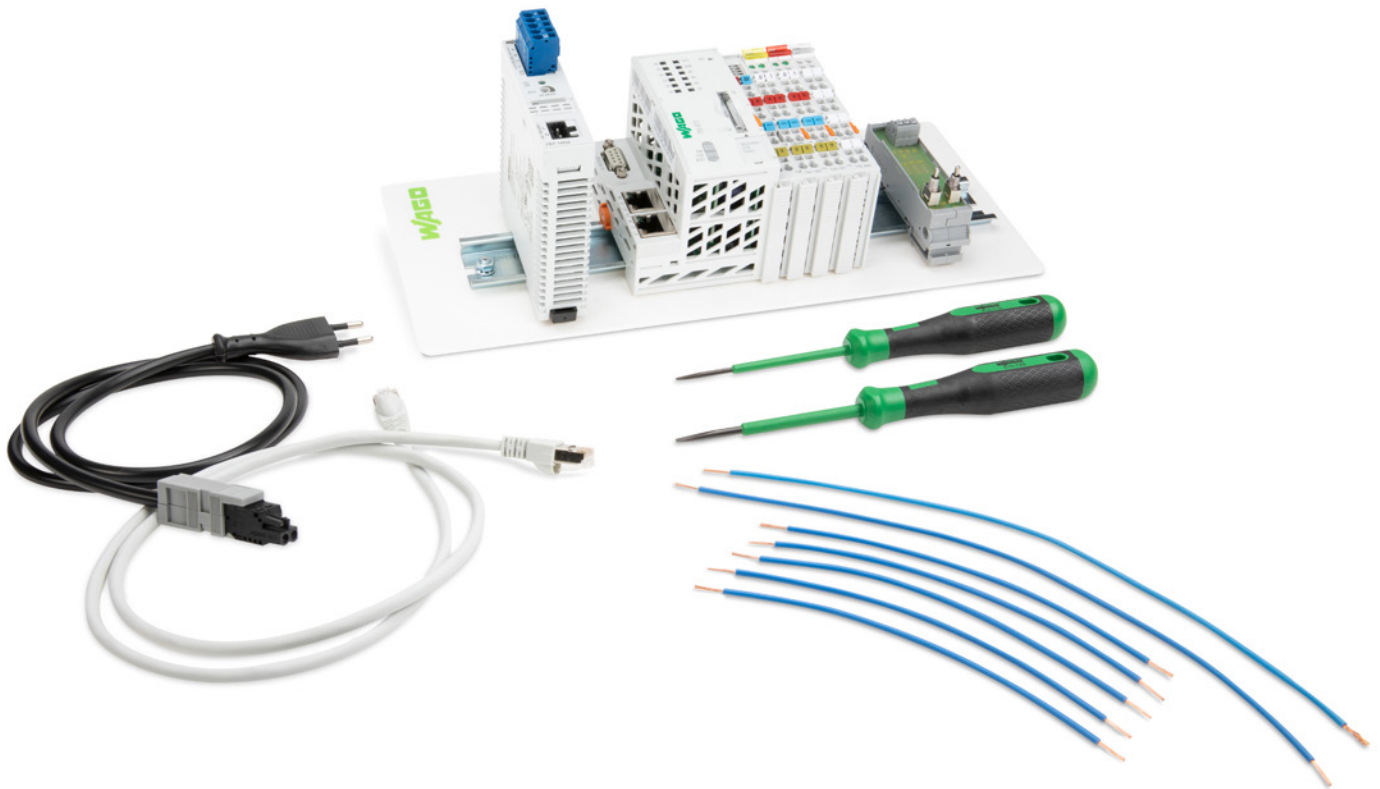
The PFC100 Controller can be seamlessly integrated into WAGO's e!COCKPIT Engineering Software, which can be used for hardware configuration, programming, simulation and visualization of complex control tasks.

Tightly integrated automation software and controller hardware provide the ideal platform for advanced and intuitive CODESYS V3-based engineering.

4.5

Item Description	Item No.
<b>Starter Kit; e!COCKPIT</b>	<b>8003-099/750-8100</b>
<b>The e!COCKPIT Starter Kit includes:</b>	
Controller PFC100; 2 x ETHERNET; Eco	750-8100
Supply Module; 24 VDC	750-602
2-Channel Digital Input; 24 VDC; 3 ms	750-400
2-Channel Digital Output; 24 VDC; 0.5 A	750-501
End Module	750-600
Power Supply "Classic"; 24 VDC output voltage; 1 A	787-1602
Switching Module; 2-way DI simulator	288-863
Development Environment e!COCKPIT; Licence for 1 PC	2759-0101/1111-5000
USB Communication Cable; 2.5 m	750-923
microSD Memory Card; 2 Gbytes	758-879/000-3102
Operating Tool; Type 1; (3.5 x 0.5) mm blade	210-720
Operating Tool; Type 1; (2.5 x 0.4) mm blade	210-719
Patch Cable; 1.0 m	

## Starter Kit; Linux® with Controller PFC200



With the PFC200 Controller as its central component, the Linux® Starter Kit provides an entry to the world of open programming. In addition to its scalability through the open-source community, the primary advantage of having a controller with an open-source operating system is that it is continually being developed further and maintained.

Besides the PFC200, other components of the starter kit include input and output modules, a power supply, a switching module and the accessories needed to start programming immediately with Linux®.

Additional information on Linux® is available at:  
[wago.com/linux](http://wago.com/linux)

4.5

Item Description	Item No.
Starter Kit; Linux®	807-099/750-8212

### The Linux® advanced Starter Kit includes:

Controller PFC200; 2nd generation; 2 x ETHERNET, RS-232/-485	750-8212
2-Channel Digital Input; 24 VDC; 3 ms	750-400
2-Channel Digital Output; 24 VDC; 0.5 A	750-501
End Module	750-600
Power Supply "Classic"; 24 VDC output voltage; 1 A	787-1602
Switching Module; 2-way DI simulator	288-863
Operating Tool; Type 1; (3.5 x 0.5) mm blade	210-720
Operating Tool; Type 1; (2.5 x 0.4) mm blade	210-719
Patch Cable; 1.0 m	

## Starter Kit; ETHERNET 880 with Controller ETHERNET; 3rd Generation; SD card slot



This ETHERNET Starter Kit includes: 750-880 Controller, 2-channel input module and 2-channel output module. A power supply and the required programming software are also included in the scope of delivery. An application program designed for the starter kit and written in IEC 61131 demonstrates both hardware and software possibilities.

### 4.5

Item Description	Item No.
Starter Kit; ETHERNET 880	8003-001/K999-9999/000-1700

#### The ETHERNET Starter Kit includes:

Controller ETHERNET; 3rd generation; SD card slot	750-880
2-Channel Digital Input; 24 VDC; 3 ms	750-400
2-Channel Digital Output; 24 VDC; 0.5 A	750-501
End Module	750-600
Power Supply "Classic"; 24 VDC output voltage; 1 A	787-1602
Switching Module; 2-way DI simulator	288-863
Development Environment, incl. USB Communication Cable; WAGO-I/O-PRO; USB Kit	759-333/000-923
SD Memory Card; 1 GB	758-879/000-001
Patch Cable; 1 m	110-8006
Operating Tool; Type 1; (3.5 x 0.5) mm blade	210-720

## Starter Kit; ETHERNET 881 with Controller ETHERNET; 3rd Generation



This ETHERNET Starter Kit includes: 750-881 Controller, 2-channel input module and 2-channel output module. A power supply and the required programming software are also included in the scope of delivery. An application program designed for the starter kit and written in IEC 61131 demonstrates both hardware and software possibilities.

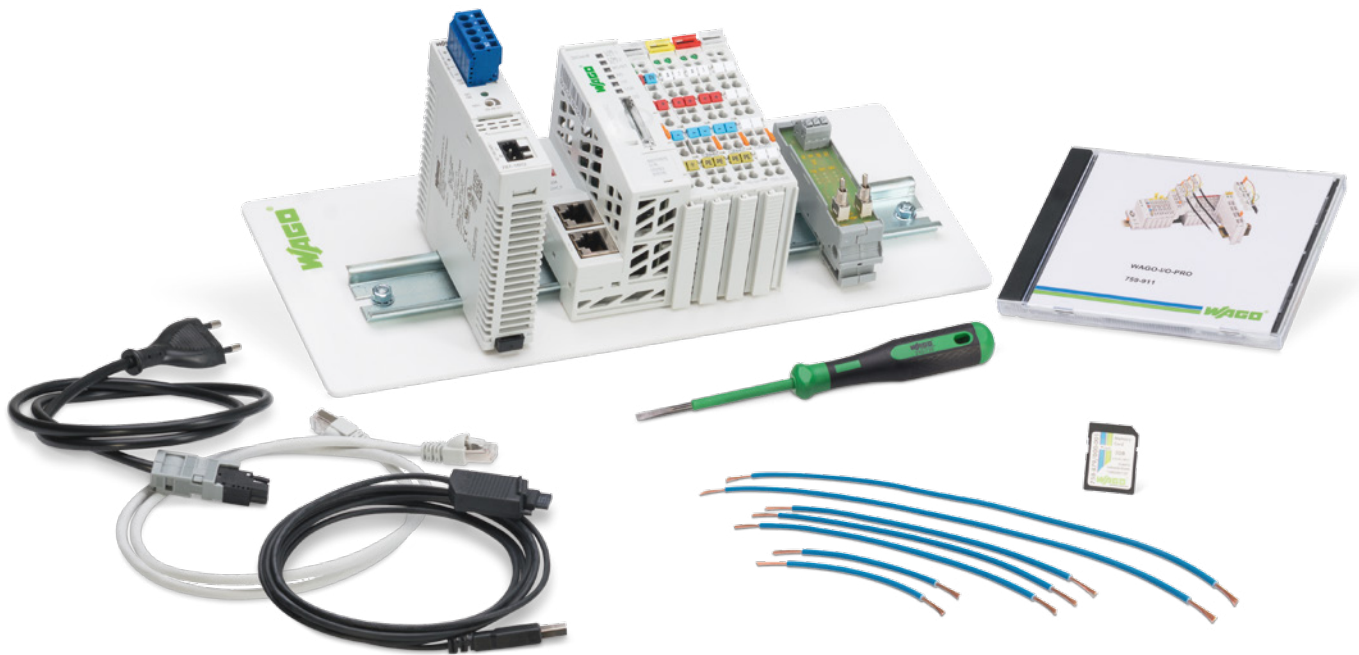
4.5

Item Description	Item No.
Starter Kit; ETHERNET 881	8003-001/K999-9999/000-1600

### The ETHERNET Starter Kit includes:

Controller ETHERNET; 3rd generation	750-881
2-Channel Digital Input; 24 VDC; 3 ms	750-400
2-Channel Digital Output; 24 VDC; 0.5 A	750-501
End Module	750-600
Power Supply "Classic"; 24 VDC output voltage; 1 A	787-1602
Switching Module; 2-way DI simulator	288-863
Development Environment, incl. USB Communication Cable; WAGO-I/O-PRO; USB Kit	759-333/000-923
SD Memory Card; 1 GB	758-879/000-001
Patch Cable; 1 m	110-8006
Operating Tool; Type 1; (3.5 x 0.5) mm blade	210-720

## Starter Kit; BACnet/IP with Controller BACnet/IP; Eco



The BACnet/IP Starter Kit is perfect for anyone seeking flexibility. Whether for rooms, lighting control systems or HVAC systems, the high-performance BACnet/IP Eco Controller is always the right choice for building automation applications.

Advantages of the BACnet/IP Eco Controller:

- This controller supports the device profile of a BACnet Building Controller (B-BC) with all major BACnet objects and interoperability building blocks (BIBBs).
- With 256 BACnet objects, the BACnet/IP Eco Controller is an economical alternative for building automation applications requiring a small number of BACnet objects.
- This permits smaller building automation control tasks to be implemented much more cost-effectively.

4.5

Item Description	Item No.
<b>Starter Kit; BACnet/IP</b>	<b>8003-099/750-831</b>
<b>The BACnet/IP Starter Kit includes:</b>	
Controller BACnet/IP; Eco	750-831/000-002
2-Channel Digital Input; 24 VDC; 3 ms	750-400
2-Channel Digital Output; 24 VDC; 0.5 A	750-501
End Module	750-600
Power Supply "Classic"; 24 VDC output voltage; 1 A	787-1602
Switching Module; 2-way DI simulator	288-863
Development Environment, incl. USB Communication Cable; WAGO-I/O-PRO; USB Kit	759-333/000-923
Operating Tool; Type 1; (3.5 x 0.5) mm blade	210-720
Patch Cable; 1.0 m	



## Starter Kit; KNX IP with Controller KNX IP



The WAGO Starter Kit KNX IP is available for those new to KNX IP. This starter kit is particularly well-suited to users seeking to:

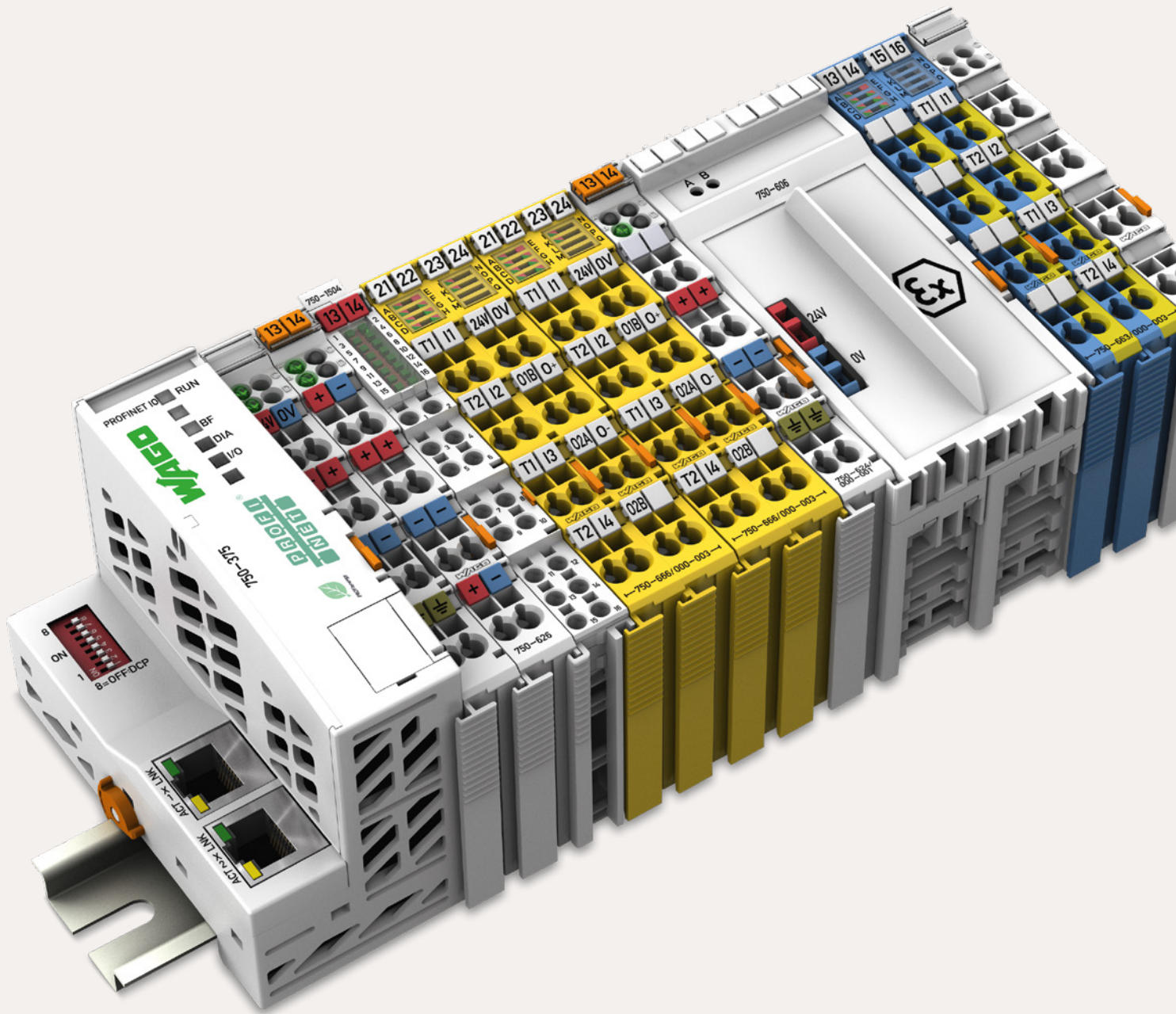
- Expand existing KNX/EIB networks with the KNX/EIB/TP1 interface to include the functionality of the modular WAGO-I/O-SYSTEM and program applications themselves (IEC 61131-3)
- Have remote access to their KNX/EIB/TP1 network with the router
- Exploit the advantages of an ETHERNET network with KNX/EIB projects via the IP controller

4.5

Item Description	Item No.
Starter Kit; KNX IP	8003-001/K999-9999/000-901

### The KNX IP Starter Kit includes:

Controller KNX IP	750-889
4-Channel Digital Input; 24 VDC; 3 ms	750-402
4-Channel Digital Output; 24 VDC; 0.5 A	750-504
End Module	750-600
KNX/EIB/TP1 Interface	753-646
Switched-Mode Power Supply; 24 VDC output voltage; 1.3 A	787-602
Development Environment, incl. USB Communication Cable; WAGO-I/O-PRO; USB Kit	759-333/000-923
Patch Cable; Cross-Over	



## I/O System – 750 and 753 Series

### I/O System – 750 and 753 Series





- Highly versatile
- More than 500 modules available
- Functional Safety
- Ex i

### I/O System – 750 XTR Series

- For demanding applications in which the following are critical:
- Extreme temperature stability
  - Immunity to electromagnetic interference and impulse voltages
  - Vibration and shock resistance

# I/O System – 750 and 753 Series

## Contents

			Page
	General Product Information		138
	Variants		139
	Interfaces and Types		140
	Marking and Mounting Accessories		141
	Application and Installation Instructions		142
	Item Number Key		144
	Standards and Rated Conditions		145
	Approvals		145
	Fieldbus Couplers (FC)	PROFINET IO, PROFIBUS, Ethernet TCP/IP, BACnet/IP, EtherCAT, Modbus/TCP, DeviceNet, CANopen, sercos, MODBUS, INTERBUS, CC-Link	146
	I/O Modules	Digital Input Modules (DI)	162
		Digital Output Modules (DO)	192
		Analog Input Modules (AI)	212
		Analog Output Modules (AO)	246
		Function/Technology Modules	256
		Communication Modules	276
		Functional Safety Modules	296
		Intrinsically Safe Modules	308
	Supply/Segment Modules		322
	Accessories		Section 10
	Marking and Mounting Accessories		Section 10

# I/O System – 750 and 753 Series – One System for Every Application

## General Product Information

### One System for Every Application

The WAGO-I/O-SYSTEM 750/753 is characterized by its universal application scope and extensive product portfolio. With more than 500 different modules, the versatility and flexibility is so great that virtually every requirement in a wide range of industries is covered.

### Industrial Automation

The comprehensive selection of I/O modules for different potentials and signal types saves time and money because the sensors/actuators can be wired directly – even in safety-related applications.

### Building Automation

The broad portfolio enables flexible, cellar-to-ceiling solutions with conventional I/O modules, standardized industry-specific fieldbus protocols and subsystems for typical applications in lighting, shading, heating, HVAC and much more.

### Marine and Onshore/Offshore Automation

International approvals coupled with industry-specific features permit use in shipbuilding and other harsh sectors. Addressing requirements inherent in specific industries and operating environments has enabled use on marine diesels and in the EMC-sensitive area of a vessel's bridge. Because the requirements are significantly greater for immunity to interference or emission of interference, along with superior mechanical performance in these sensitive areas, the WAGO-I/O-SYSTEM can readily meet the needs of other industries.

### Process Automation

Even under the harshest environmental conditions, use is possible with special approvals. Potential hazardous area applications include oil and gas production, the chemical industry and power generation. The WAGO-I/O-SYSTEM can be installed in Zone 2/22 with its intrinsically safe I/O modules, making it possible to connect sensors/actuators in Zones 1/21 and 0/20.

### Maximum Fieldbus Independence

The system's modularity is also reflected in its support for numerous fieldbus systems and ETHERNET standards. Depending on the application, it is possible to choose between fieldbus couplers and communication modules for different protocols.

### Easy to Use

A modular, DIN-rail-mount design permits easy installation, expansion and modification of the I/O node without tools. The streamlined design prevents installation errors. In addition, proven CAGE CLAMP® technology offers fast, vibration-proof and maintenance-free connections that are independent of operator skill. Depending on the I/O module's granularity, field peripherals can be directly wired using 1-, 2-, 3- or 4-wire technology.

### Worldwide Approvals

International approvals for building and industrial automation, as well as the process and marine industries, guarantee worldwide use – even under more rigorous operating conditions including ATEX, BR-Ex, IECEx, UL508, UL ANSI/ISA, AEx and numerous marine certifications.

### Extremely Compact

WAGO's patented mechanical design leads to extremely compact I/O nodes. In fact, it can accommodate up to 16 channels in a module width of 12 mm (1/2").

- Finely granular I/O modules provide node customization.
- Space-saving design permits high integration density and direct connection.

### Maximum Reliability and Ruggedness

The WAGO-I/O-SYSTEM is engineered and tested for use in the most demanding environments in accordance with the highest standards, e.g., those required in marine applications. The system is distinguished from other products that are solely intended for industrial use because of:

- Greatly increased vibration rating
- Significantly greater immunity to interference (ESD)
- Lower emission of interference
- Larger voltage fluctuation range
- Greater durability for continuous operation in upper temperature ranges

In addition, CAGE CLAMP® spring pressure connections ensure superior reliability. Integrated QA measures in the production process and 100% function testing ensure consistent quality.

### Clear Identification

Module functionality is identified via integrated or pluggable marker carriers. Terminal assignment and technical data are printed onto the side of the I/O module. WAGO's WSB Marking System also allows for module- and channel-related identification.

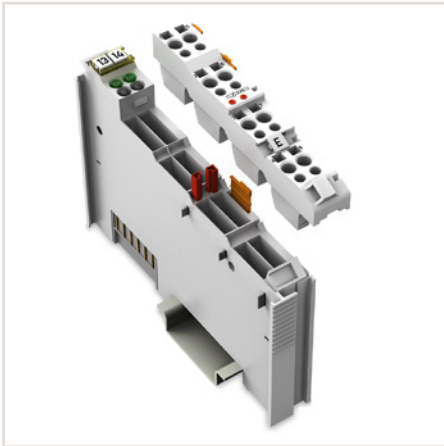


### Advantages:

- Fieldbus-independent – support all standard fieldbus protocols and ETHERNET standards
- Flexible platform adapts to diverse applications and environments
- Tested and approved worldwide
- Extensive range of accessories for marking systems and connection technologies
- Vibration-proof, fast and maintenance-free CAGE CLAMP® connections

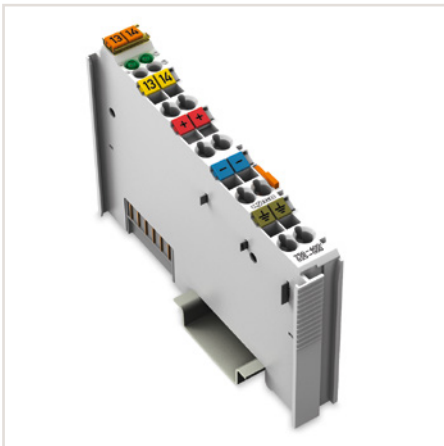
## I/O System – 750 and 753 Series Variants

### Pluggable Connector



The pluggable connections of the WAGO-I/O-SYSTEM 753 allow quick and safe replacement. Optional coding pins prevent inserting the pluggable connector in the wrong I/O module. Replacing and connecting the I/O module requires no further action and eliminates possible errors – essentially serving as permanent wiring. Alternatively, field wiring is possible via interface modules that can be connected to the I/O system using a ribbon cable (see “Types”).

### Extended Temperature Range



Industrial automation technology is typically operated in temperatures ranging from 0 °C to 55 °C. However, there are applications that require an extended temperature range. For these applications, WAGO offers a line of WAGO-I/O-SYSTEM 750 products for temperatures ranging from –20°C to +60°C. For extreme applications, where even this extended temperature range is not sufficient, the WAGO-I/O-SYSTEM 750 XTR is available.

### Functional Safety



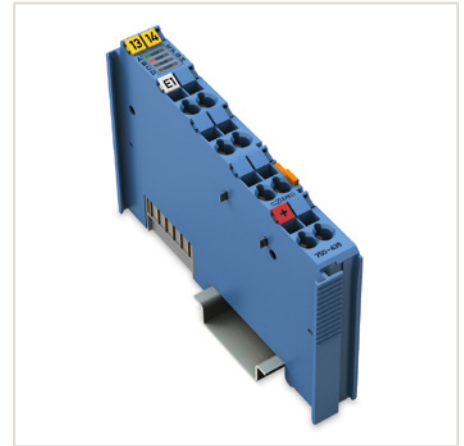
In the European Union, the machinery directive defines the requirements for machine and system safety. This ensures a uniform standard for the protection of “life and limb” for people within a machine’s operating area.

The required risk assessment is based on harmonized standards (e.g., EN 13849) that identify existing risks and required risk reduction (SIL or PL quality). Based on the risk assessment, safety functionality can be implemented, e.g., by presence detection or protection zone violations using secure switches or light arrays to immediately shut down the “risk.” For this purpose, the safety signals are detected by the “yellow” safety modules and transmitted via “PROFIsafe” to the fail-safe PLC for further processing. The result is then executed via safe actuator (e.g., output module or controller).

The uniquely characteristic safety values of the WAGO modules facilitate calculation of the final safety function up to Cat. 4/PLe according to EN 13849, or SIL3 according to EN 62061 or IEC 61511.

The mixed operation of safe and conventional I/O modules streamlines system configuration. For increased electromagnetic immunity (EMC standard), WAGO offers compact power supply filter modules. Specific power supply features must be considered, which are described in detail in the corresponding manuals.

### Use in Hazardous Areas

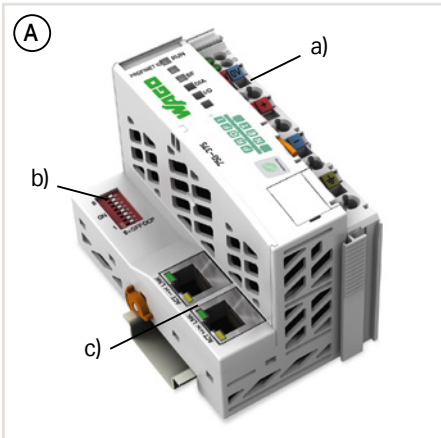


In many plants across the chemical and petrochemical industries, as well as in the production and process automation sectors, installations are operated that process explosive gas- or dust-air mixtures. This is why electrical equipment must be explosion-proof in order to avoid injuries to personnel and damage to facilities.

The modules within the WAGO-I/O-SYSTEM 750 are designed for use in both non-hazardous and hazardous areas.

The direct application of fieldbus technology in hazardous areas is typically resource-intensive. When used in hazardous areas of Zone 2/22, the WAGO-I/O-SYSTEM 750 offers a safe, easy and economical connection to the sensors and actuators of Zones 0/20 and 1/21. The “blue” Ex i I/O modules were specially developed for this purpose. They form an intrinsically safe section that can be integrated into a standard fieldbus node, offering all the advantages of state-of-the-art fieldbus technology. The WAGO-I/O-SYSTEM 750 is also approved for mining applications.

## I/O System – 750 and 753 Series Interfaces and Types

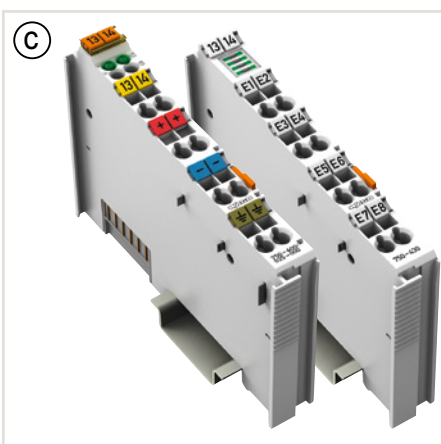
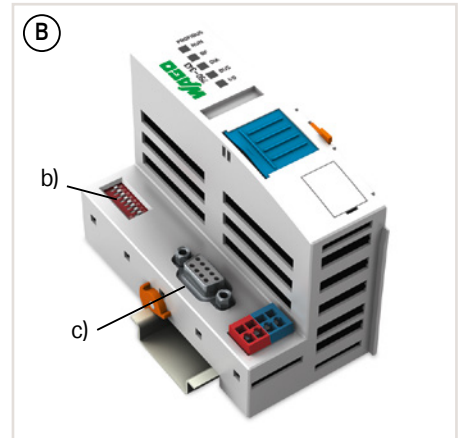


### Housing design: fieldbus coupler (A)

- Including supply module (a) to power downstream I/O modules
- Technical differences on the connection level; optional addressing switch (b) and fieldbus interface (c)
- W x H x D (mm) 50.5 x 71.1 x 100 or
- W x H x D (mm) 61.5 x 71.9 x 100

### Housing design: fieldbus coupler ECO (B)

- Restriction on power supply and data width
- W x H x D (mm) 49.5 x 71.9 x 96.8

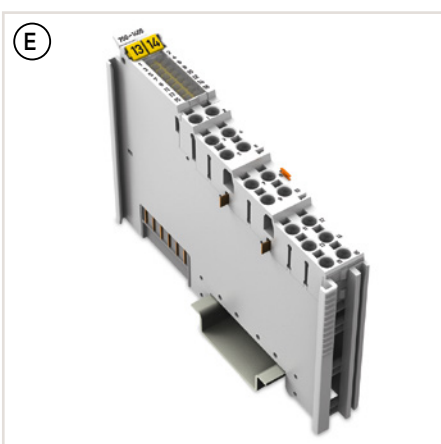
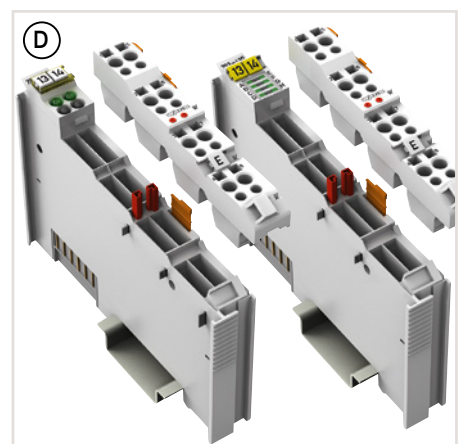


### Housing design: 750 (C)

- 8 connection points (CAGE CLAMP®)
- W x H x D (mm) 12 x 69.8 x 100 (4 LEDs)
- W x H x D (mm) 12 x 67.8 x 100 (8 LEDs)

### Housing design: 753 (D)

- Pluggable Connector
- 8 connection points (CAGE CLAMP®)
- W x H x D (mm) 12 x 69.8 x 100 (4 LEDs)
- W x H x D (mm) 12 x 69 x 100 (8 LEDs)
- Pluggable connectors and coding fingers are not included.

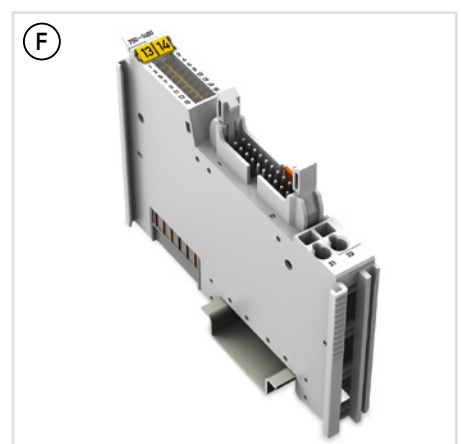


### Housing design: 750 (E)

- 16 connection points (Push-in CAGE CLAMP®)
- W x H x D (mm) 12 x 69 x 100

### Housing design (F)

- For time-saving wiring between I/O system and interface modules
- Ribbon cable connection to interface modules (289 and 704 Series) and interface adapter
- W x H x D (mm) 12 x 74.1 x 100

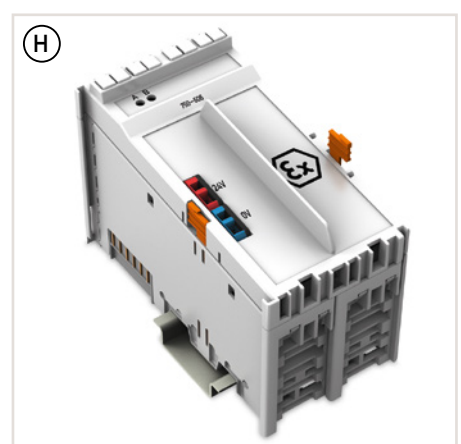


### Housing design: double width (G)

- Some modules are integrated into a double housing to address specific technological needs. Despite utilizing the same standardized housing, these modules are twice as wide.
- W x H x D (mm) 24 x 69.8 x 100

### Special housing design (H)

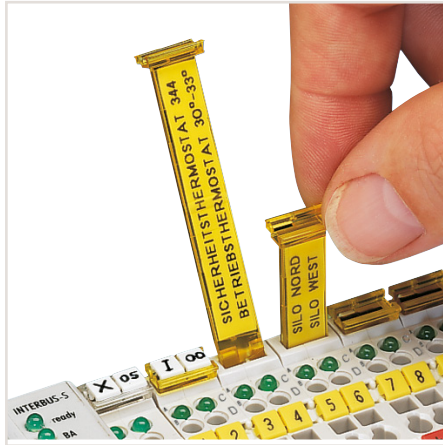
- Some modules are integrated into a specialized housing with a specific width and pluggable connectors. The dimensions are specified on the respective catalog page.



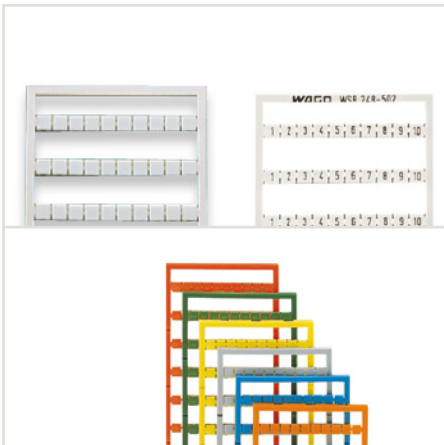
## I/O System – 750 and 753 Series Marking and Mounting Accessories



Transparent group marker carriers indicate module type by color.



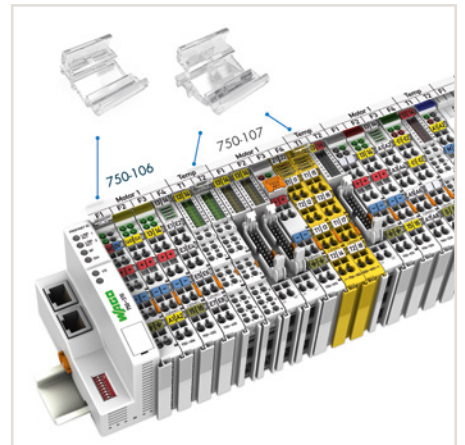
Removable group marker carriers are available for all 750 and 753 Series I/O Modules with a maximum of four LEDs, as well as all fieldbus couplers with a supply module.



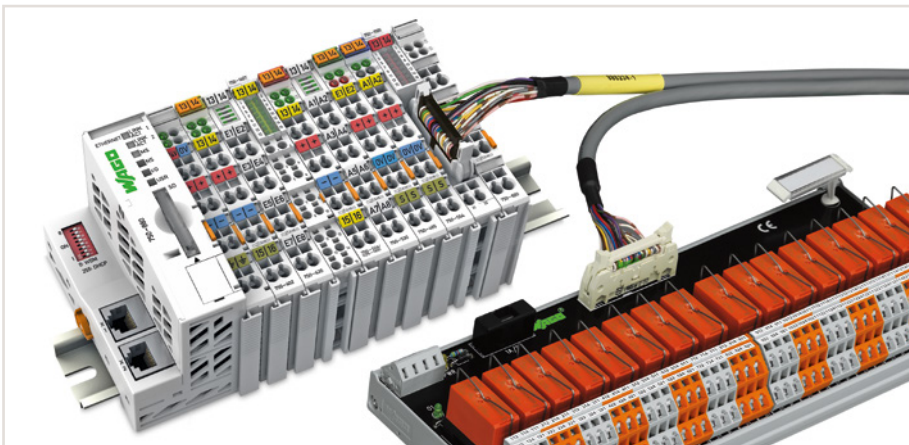
Mini-WSB Quick Marking System, blank, pre-marked and colored; suitable for all 750 and 753 Series I/O Modules.



Marker carrier for one single I/O module (suitable for all 750 and 753 Series I/O Modules); the marker carrier can be accommodated in the upper Mini-WSB marker slot.



Marker carrier for one I/O node; both carrier models (750-106 and 750-107) permit continuous marking regardless of the I/O module housing used.



Interface modules for system wiring



Interface cables

# I/O System – 750 and 753 Series

## Application and Installation Instructions

### Power Supply

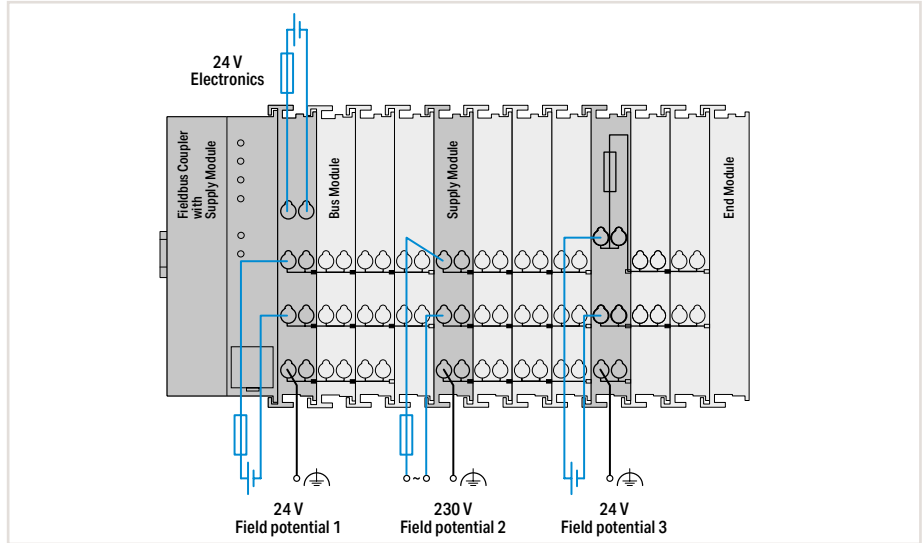
The internal electronics are powered by the fieldbus coupler. The field-side power supply is electrically isolated via the supply module on the coupler or a separate power supply module. This division enables a separate supply for sensors and actuators. Snapping the I/O modules together automatically routes the supply voltages (system power supply 5 VDC via the data contacts and field supply via the optional power jumper contacts). Supply modules with diagnostics also enable power supply monitoring. This ensures a flexible, user-specific supply design for a station.

Power supply to the electronics is limited by a maximum value. This value depends on the fieldbus coupler used. If the sum of the internal current demand of all the I/O modules should exceed this value, an additional system supply module is necessary. Even in this case, power supply to the field-side supply of 10 A may not be exceeded. However, different power supply modules allow a new power supply, formation of potential groups and the implementation of emergency stop concepts.

### Interference-Free in Safety-Related Applications

To easily and safely perform cost-effective, centralized deactivation of complete actuator groups, the actuator's power supply can be switched off using a safety switching device. This can either be performed for each individual actuator or by turning off the power supply to a group of control outputs. In the event of failure, ensure that no interference from other current or power circuits occurs – even when the control voltage is switched off – so the defined safety function properties (logic and time response) remain unchanged.

Some modules are designed to provide interference-free safety functionality. These modules comply with safety requirements up to Category 4 of DIN EN ISO 13849-1:2007. Safety category and performance level depend solely on the safety components and their wiring.



### Notice:

WAGO's interference-free I/O modules are not a component of the safety function and do not replace the safety switching device! When using the components in safety functions, the corresponding notes must be observed in the relevant manual.

### Notes:

Additional steps must be implemented based on where the I/O system is installed:

Specific field-side power supply filters (750-624) or power supply filters (750-626) are required for marine and onshore/offshore applications.

A specific supply module (750-606) is required to operate intrinsically safe Ex i modules.

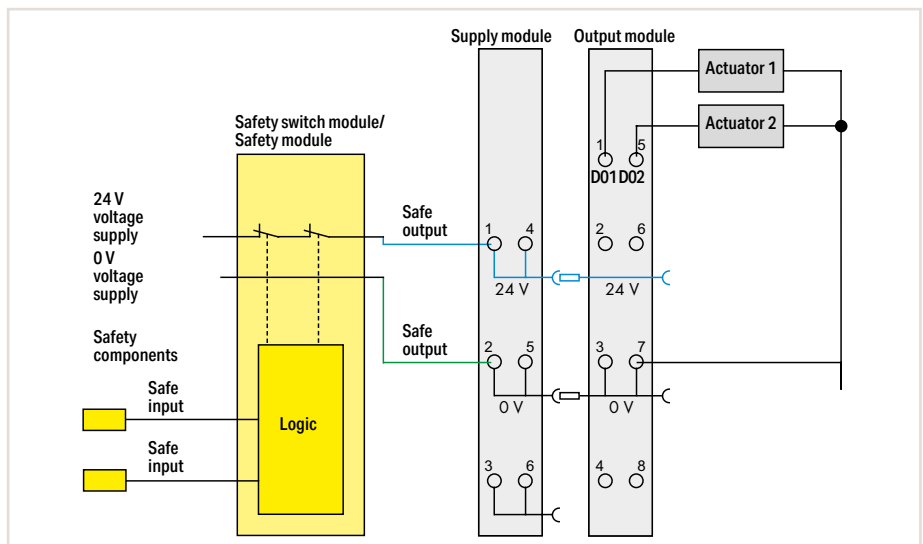
Additionally, both supply modules and field-side power supply filters are recommended

when operating intrinsically safe Ex i modules for marine and onshore/offshore applications.

For the 24 VDC power supply of electronics and field, PELV/SELV power supply units are recommended. As part of safety-related applications, they are mandatory. The mixed operation of safe and conventional I/O modules streamlines system configuration. For increased electromagnetic immunity (EMC standard), WAGO offers compact power supply filter modules.

Please refer to the manual for details about the power supply's design.

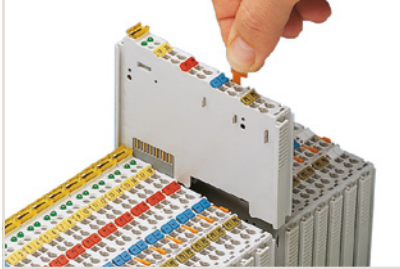
5



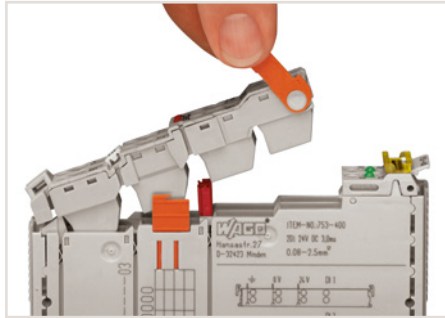
Example: 2-channel, double-pole power supply disconnection



# I/O System – 750 and 753 Series Application and Installation Instructions



Securing/removing a module from the mounting rail.



Releasing a pluggable connector.



Optional protection against mismatching of pluggable connectors via coding elements

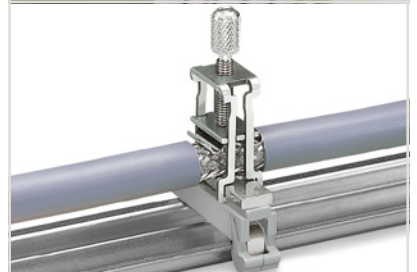


Service interface for configuring the fieldbus coupler; connectivity via configuration cable or radio adapter

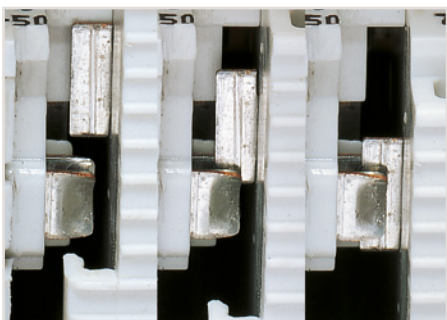
### Notice:

For some I/O modules, not all power jumper contacts are made! A module with three power jumper contacts (e.g., 2-channel digital input) cannot be snapped into place behind a module in which not every contact is made.

To increase electromagnetic compatibility (EMC), some components are connected to the DIN-rail by a discharge contact. The DIN-rail must always have a low-resistance connection to the ground potential.



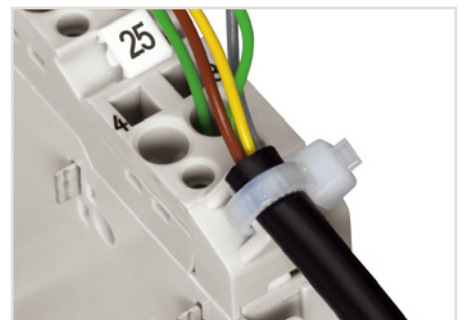
Wide range of accessories available for EMC-compliant installation, including shield connection



Secure, automatic power supply connection via self-cleaning blade contacts



Secure, automatic data and electronics power supply connection via gold-plated pressure contacts

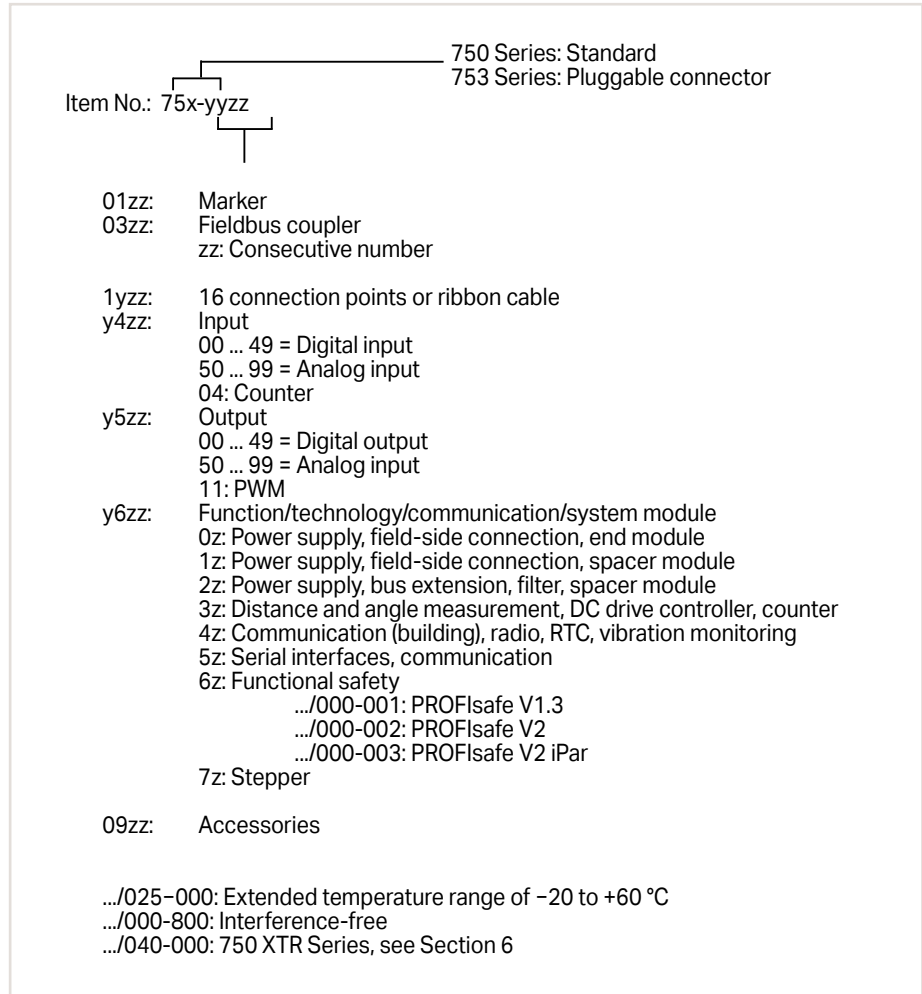


Securing a cable to the connector.

## I/O System – 750 and 753 Series

### Item Number Key

Explanation of item number key's components



## I/O System – 750 and 753 Series

### Standards and Rated Conditions

General Specifications	
Supply voltage (system)	24 VDC (-25 % ... +30 %)*; *for all marine-certified fieldbus couplers and I/O modules
Isolation	500 V (system/supply)
Surrounding air temperature (operation)	0 ... +55 °C
Surrounding air temperature (operation) for versions with an extended temperature range	-20 ... +60 °C
Surrounding air temperature (storage)	-40 ... +85 °C
Relative humidity	95 % (non-condensing)
Relative humidity for versions with an extended temperature range	Max. 95 %; short-term condensation per Class 3K6 / IEC EN 60721-3-3 and E DIN 40046-721-3, taking a temperature range of -20 to +60 °C into consideration (except wind-driven precipitation, water and ice formation)
Operating altitude	0 ... 2000 m
Pollution degree	2 per IEC 61131-2
Vibration resistance	0.5g (4g for all marine-certified fieldbus couplers and I/O modules) per IEC 60068-2-6
Shock resistance	15g per IEC 60068-2-27
EMC immunity to interference	Per EN 61000-6-2
EMC emission of interference	Per EN 61000-6-3; EN 61000-6-4
Protection type	IP20
Mounting type	DIN-35 rail mounting
Housing material	Polycarbonate; polyamid 6.6
Exposure to pollutants	Per IEC 60068-2-42 and IEC 60068-2-43
Permissible SO <sub>2</sub> contaminant concentration at a relative humidity < 75 %	25 ppm
Permissible H <sub>2</sub> S contaminant concentration at a relative humidity < 75 %	10 ppm
Connection technology	CAGE CLAMP®
Conductor cross section; strip length for Standard modules and couplers: I/O modules, 753 Series: ECO fieldbus couplers:	0.08 ... 2.5 mm <sup>2</sup> /28 ... 14 AWG; 8 ... 9 mm/0.31 ... 0.35 inch 0.08 ... 2.5 mm <sup>2</sup> /28 ... 14 AWG; 9 ... 10 mm/0.35 ... 0.39 inch 0.08 ... 1.5 mm <sup>2</sup> /28 ... 16 AWG; 5 ... 6 mm/0.2 ... 0.24 inch
Connection technology	Push-in CAGE CLAMP®
Conductor cross section; strip length for I/O modules with 16 connection points:	Solid: 0.08 ... 1.5 mm <sup>2</sup> /28 ... 16 AWG, Fine-stranded: 0.25 ... 1.5 mm <sup>2</sup> /22 ... 16 AWG; 8 ... 9 mm/0.31 ... 0.35 inch
Current carrying capacity (power jumper contacts)	10 A

## Approvals

Overview of the approvals in the item comparison in Section 11, Technical Section, or online under [www.wago.com](http://www.wago.com)



# Fieldbus Couplers

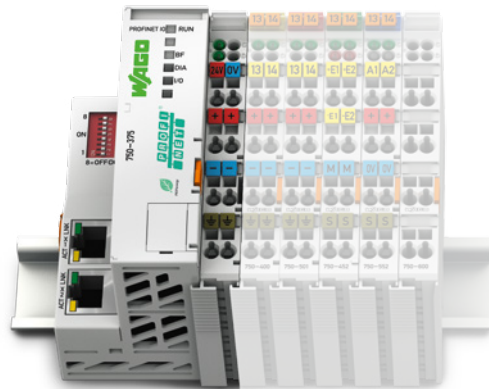
## Housing design I with field supply

Dimensions W x H x D	50.5 x 71.1 x 100 mm
Height from upper-edge of DIN-rail	63.9 mm
Connection technology: System supply and field supply	CAGE CLAMP®
Conductor cross section	0.08 ... 2.5 mm <sup>2</sup> / 28 ... 14 AWG
Strip length	8 ... 9 mm / 0.33 inch



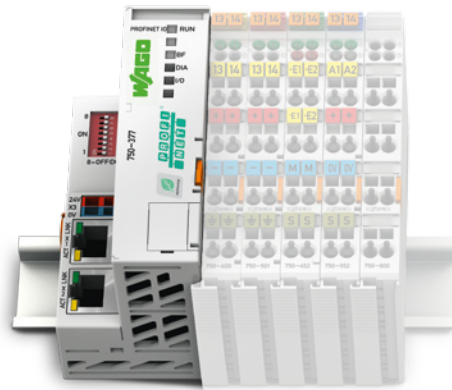
## Housing design II with field supply

Dimensions W x H x D	61.5 x 71.9 x 100 mm
Height from upper-edge of DIN-rail	64.7 mm
Connection technology: System supply and field supply	CAGE CLAMP®
Conductor cross section	0.08 ... 2.5 mm <sup>2</sup> / 28 ... 14 AWG
Strip length	8 ... 9 mm / 0.33 inch



## Housing design without field supply

Dimensions W x H x D	49.5 x 71.9 x 96.8 mm
Height from upper-edge of DIN-rail	64.7 mm
Connection technology: System supply	CAGE CLAMP®
Conductor cross section	0.08 ... 1.5 mm <sup>2</sup> / 28 ... 16 AWG
Strip length	5 ... 6 mm / 0.22 inch

















## Housing design "Eco" (without field supply)

Dimensions W x H x D	49.5 x 71.9 x 96.8 mm
Height from upper-edge of DIN-rail	64.7 mm
Connection technology: System supply	CAGE CLAMP®
Conductor cross section	0.08 ... 1.5 mm <sup>2</sup> / 28 ... 16 AWG
Strip length	5 ... 6 mm / 0.22 inch



# I/O System – 750 and 753 Series, Fieldbus Couplers

## Contents

Fieldbus System	Housing Design				Description	Item No.	Page
	With Field Supply		Without Field Supply	Eco			
							
		<input type="checkbox"/>			PROFINET IO; 3rd generation; Advanced	750-375	148
		<input type="checkbox"/>			PROFINET IO; 3rd generation; Extended temperature; Advanced	750-375/025-000	148
			<input type="checkbox"/>		PROFINET IO; 3rd generation; Eco Advanced	750-377	148
			<input type="checkbox"/>		PROFINET IO; 3rd generation; Extended temperature; Eco Advanced	750-377/025-000	148
	<input type="checkbox"/>				PROFIBUS DP; 1st generation; 12 MBd	750-303	149
	<input type="checkbox"/>				PROFIBUS DP; 2nd generation; 12 MBd	750-333*	149
	<input type="checkbox"/>				PROFIBUS DP; 2nd generation; 12 MBd; Extended temperature	750-333/025-000	149
				<input type="checkbox"/>	PROFIBUS DP; 12 MBd; Eco	750-343	150
	<input type="checkbox"/>				PROFIBUS DP; Fiber-optic connection; 1.5 MBd	750-331	150
			<input type="checkbox"/>		ETHERNET; 3rd generation	750-352*	151
	<i>MODBUS/TCP</i>		<input type="checkbox"/>		ETHERNET; 3rd generation	750-352/000-001	151
<i>MODBUS/TCP</i>			<input type="checkbox"/>		Modbus TCP; 4th generation	750-362	151
	<input type="checkbox"/>				ETHERNET; 1st generation	750-342	152
		<input type="checkbox"/>			BACnet/IP	750-330	153
			<input type="checkbox"/>		EtherCAT	750-354	154
			<input type="checkbox"/>		EtherCAT; ID switch	750-354/000-001	154
			<input type="checkbox"/>		EtherCAT; ID switch; Diagnostics	750-354/000-002	154
	<input type="checkbox"/>				DeviceNet	750-306	155
				<input type="checkbox"/>	DeviceNet; Eco	750-346	155
	<input type="checkbox"/>				CANopen	750-307	156
	<input type="checkbox"/>				CANopen; MCS	750-337	156
	<input type="checkbox"/>				CANopen; MCS; Extended temperature	750-337/025-000	156
	<input type="checkbox"/>				CANopen; D-Sub	750-338*	157
				<input type="checkbox"/>	CANopen; MCS; Eco	750-347	157
				<input type="checkbox"/>	CANopen; D-Sub; Eco	750-348	157
	<input type="checkbox"/>				Sercos®	750-351	158
<i>MODBUS</i>	<input type="checkbox"/>				MODBUS; RS-485; 115.2 kBd	750-315/300-000	159
	<input type="checkbox"/>				MODBUS; RS-232; 115.2 kBd	750-316/300-000	159
	<input type="checkbox"/>				INTERBUS	750-304	160
				<input type="checkbox"/>	INTERBUS; 500 kBit/s; Eco	750-344	160
	<input type="checkbox"/>				CC-Link	750-310	161
		<input type="checkbox"/>			CC-Link; 156 kBaud ... 10 Mbaud	750-325	161

\*This coupler is also available as a 750 XTR Series variant.

See Section 6

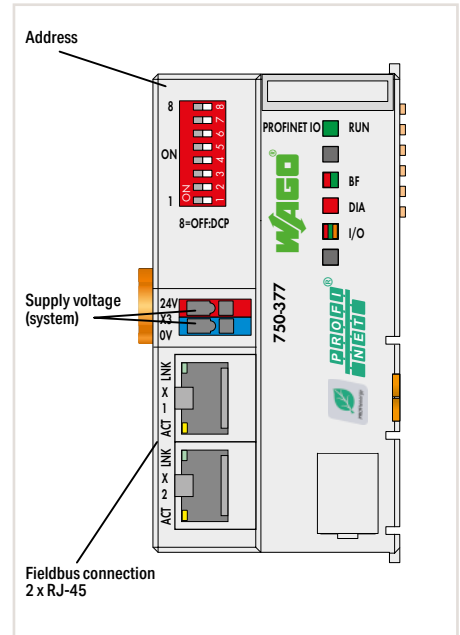
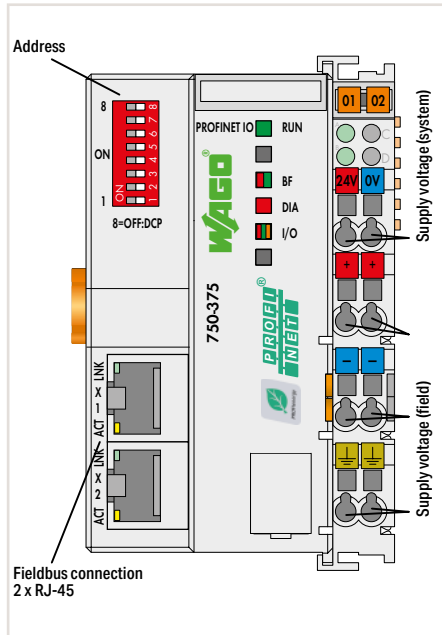
# Fieldbus Coupler PROFINET IO



Figure: 750-375



Figure: 750-377



<b>Item Description</b>
<b>Version</b>
<b>Item No.</b>
<b>Order Text</b>

Fieldbus Coupler PROFINET IO; 3rd generation; Advanced	
Standard	Extended Temperature
750-375	750-375/025-000
FC PROFINET; G3; Adv	FC PROFINET; G3; T; Adv

Fieldbus Coupler PROFINET IO; 3rd generation; Eco Advanced	
Standard	Extended Temperature
750-377	750-377/025-000
FC PROFINET; G3; Eco Adv	FC PROFINET; G3; T; Eco Adv

**Technical Data**

Fieldbus
Protocols

PROFINET IO
PROFINET IO V2.3 (conformity class C); Topology detection / LLDP; Network diagnostics / SNMP / MIB-2; Media redundancy / MRP; Webserver / HTTP; Shared device

PROFINET IO
PROFINET IO V2.3 (conformity class C); Topology detection / LLDP; Network diagnostics / SNMP / MIB-2; Media redundancy / MRP; Webserver / HTTP

Supported profiles
PROFINET IO features

PROFIsafe V2; PROFInergy V1.0
Integrated 2-port switch; Auto-negotiation; Auto-MDIX; Isochronous real-time communication; Transmission clock: 1 ms (RT); 1, 2, 4 ms (IRT); Device replacement without programming tool

PROFIsafe V2; PROFInergy V1.0
Integrated 2-port switch; Auto-negotiation; Auto-MDIX; Isochronous real-time communication; Transmission clock: 1 ms (RT); 1, 2, 4 ms (IRT); Device replacement without programming tool

Connection technology: Fieldbus input/output
Baud rate

2 x RJ-45
10 Mbit/s (ETHERNET protocols); 100 Mbit/s full duplex (PROFINET IO) Twisted Pair S-UTP; 100 Ω; Cat. 5

2 x RJ-45
10 Mbit/s (ETHERNET protocols); 100 Mbit/s full duplex (PROFINET IO) Twisted Pair S-UTP; 100 Ω; Cat. 5

Transmission medium
Number of modules per node (max.)
Input and output (internal) process image (max.)
Supply voltage (system)

250
512 bytes
24 VDC (-25 ... +30 %); via wiring interface (CAGE CLAMP® connection)

64
256 bytes
24 VDC (-25 ... +30 %); via wiring interface

Supply voltage (field)
Input current (typ.) at nominal load (24 V)
Current consumption – system supply (5 V)
Total current (system supply)
Surrounding air temperature (operation)
Dimensions W x H x D

24 VDC (-25 ... +30 %); via power jumper contacts	
500 mA	
450 mA	
1700 mA	
0 ... +55 °C	-20 ... +60 °C
61.5 x 71.9 x 100 mm	

280 mA	
450 mA	
700 mA	
0 ... +55 °C	-20 ... +60 °C
49.5 x 71.9 x 96.8 mm	

<b>Approvals</b>
------------------

CE; Marine; OrdLoc/HazLoc; ATEX/IECEx
--

CE; Marine; OrdLoc/HazLoc; ATEX/IECEx
--

Data sheet and further information, see:

[wago.com/750-375](http://wago.com/750-375)

[wago.com/750-377](http://wago.com/750-377)

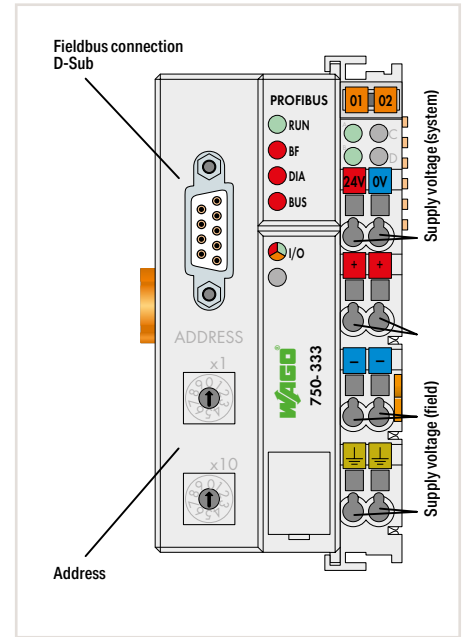
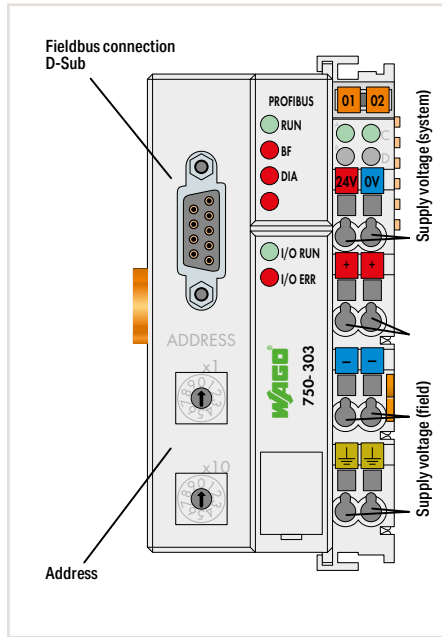
„ Mini-WSB marker card and mounting accessories, see Section “Accessories and Tools”  
 „ Approvals and corresponding ratings, see page 517 or [www.wago.com](http://www.wago.com)

# Fieldbus Coupler PROFIBUS DP



Figure: 750-303

Figure: 750-333



<b>Item Description</b>
<b>Version</b>
<b>Item No.</b>
<b>Order Text</b>

<b>Fieldbus Coupler PROFIBUS DP; 1st generation; 12 MBd</b>
<b>Standard</b>
<b>750-303</b>
FC PROFIBUS; G1; 12MBd

<b>Fieldbus Coupler PROFIBUS DP; 2nd generation; 12 MBd</b>	
<b>Standard</b>	<b>Extended Temperature</b>
<b>750-333</b>	<b>750-333/025-000</b>
FC PROFIBUS; G2; 12MBd	FC PROFIBUS; G2; 12MBd; T

<b>Technical Data</b>
Fieldbus
Protocols
Connection technology: Fieldbus input/output
Number of fieldbus nodes on master (max.)
Baud rate
Transmission medium
Number of modules per node (max.)
Input and output (internal) process image (max.)
Supply voltage (system)
Supply voltage (field)
Input current (typ.) at nominal load (24 V)
Current consumption – system supply (5 V)
Total current (system supply)
Surrounding air temperature (operation)
Dimensions W x H x D
<b>Approvals</b>
<b>Data sheet and further information, see:</b>

PROFIBUS
PROFIBUS DP/FMS
Socket D-Sub 9
96 with repeater
9.6 kBd ... 12 MBd
Copper cable per EN 50170
64
128 bytes
24 VDC (-25 ... +30 %); via wiring interface (CAGE CLAMP® connection)
24 VDC (-25 ... +30 %); via power jumper contacts
500 mA
350 mA
1650 mA
0 ... +55 °C
50.5 x 71.1 x 100 mm
CE; Marine; OrdLoc/HazLoc; ATEX/IECEX
<a href="http://wago.com/750-303">wago.com/750-303</a>

PROFIBUS	
PROFIBUS DP/V1	
Socket D-Sub 9	
96 with repeater	
9.6 kBd ... 12 MBd	
Copper cable per EN 50170	
63	
244 bytes	
24 VDC (-25 ... +30 %); via wiring interface (CAGE CLAMP® connection)	
24 VDC (-25 ... +30 %); via power jumper contacts	
500 mA	
200 mA	
1800 mA	
0 ... +55 °C	-20 ... +60 °C
50.5 x 71.1 x 100 mm	
CE; Marine; OrdLoc/HazLoc; ATEX/IECEX	
<a href="http://wago.com/750-333">wago.com/750-333</a>	

<b>Accessories</b>
GSD files

<b>Item No.</b>
Download: <a href="http://www.wago.com">www.wago.com</a>

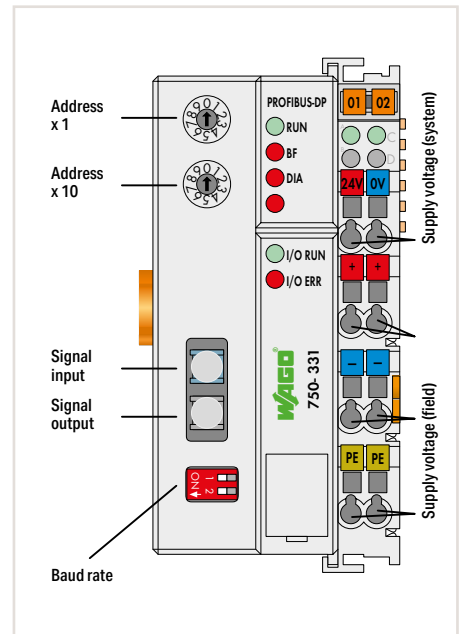
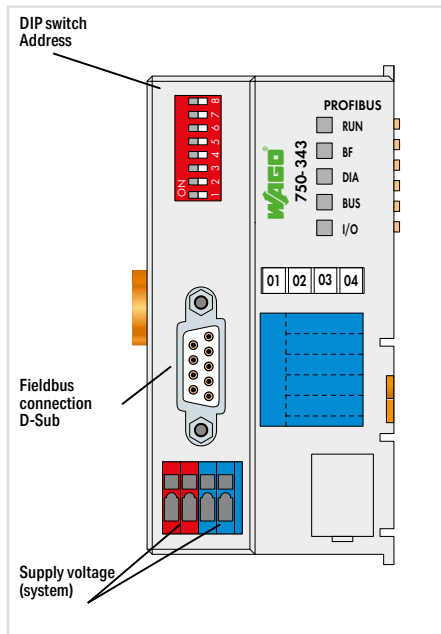
<b>Item No.</b>
Download: <a href="http://www.wago.com">www.wago.com</a>

## Fieldbus Coupler PROFIBUS DP



Figure: 750-343

Figure: 750-331



Item Description	Fieldbus Coupler PROFIBUS DP; 12 MBd; Eco	Fieldbus Coupler PROFIBUS DP; Fiber-optic connection; 1.5 MBd
Item No.	750-343	750-331
Order Text	FC PROFIBUS; 12MBd; Eco	FC PROFIBUS; FOC; 1.5MBd
<b>Technical Data</b>		
Fieldbus	PROFIBUS	PROFIBUS
Protocols	PROFIBUS DP	PROFIBUS DP
Connection technology: Fieldbus input/output	Socket D-Sub 9	HP Simplex; Fiber optic plug (included)
Number of fieldbus nodes on master (max.)	125 with repeater	10 in subring
Transmission medium	Copper cable per EN 50170	Fiber optic cable (All Plastic Fiber)
Baud rate	9.6 kBd ... 12 MBd	93.75 kBd ... 1500 kBd
Number of modules per node (max.)	63	64
Input and output (internal) process image (max.)	32 bytes	128 bytes
Supply voltage (system)	24 VDC (-25 ... +30 %); via wiring interface	24 VDC (-15 ... +20 %); via wiring interface (CAGE CLAMP® connection)
Supply voltage (field)		24 VDC (-15 ... +20 %); via power jumper contacts
Input current (typ.) at nominal load (24 V)	260 mA	500 mA
Current consumption – system supply (5 V)	350 mA	350 mA
Total current (system supply)	650 mA	1650 mA
Surrounding air temperature (operation)	0 ... +55 °C	0 ... +55 °C
Dimensions W x H x D	49.5 x 71.9 x 96.8 mm	50.5 x 71.1 x 100 mm
Approvals	CE; Marine; OrdLoc/HazLoc; ATEX/IECEX	CE; OrdLoc
Data sheet and further information, see:	<a href="http://wago.com/750-343">wago.com/750-343</a>	<a href="http://wago.com/750-331">wago.com/750-331</a>
<b>Accessories</b>		
GSD files	Item No. Download: <a href="http://www.wago.com">www.wago.com</a>	Item No. Download: <a href="http://www.wago.com">www.wago.com</a>

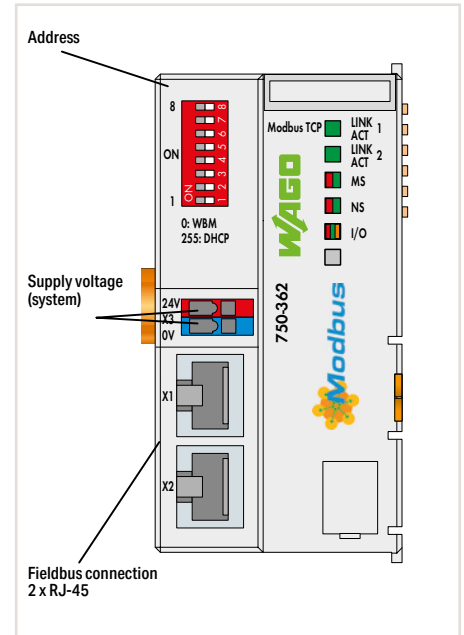
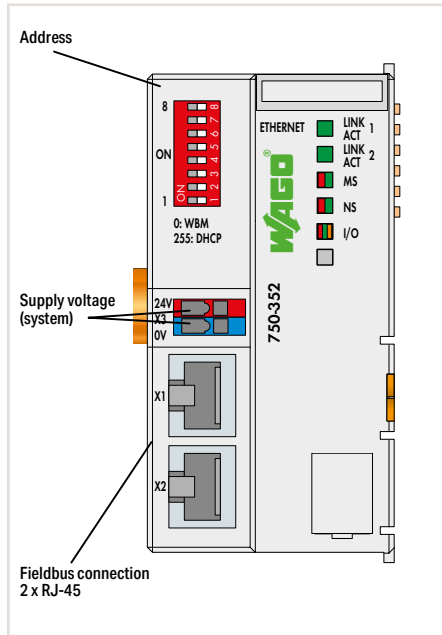
„ Mini-WSB marker card and mounting accessories, see Section "Accessories and Tools"  
 „ Approvals and corresponding ratings, see page 517 or [www.wago.com](http://www.wago.com)



# Fieldbus Coupler ETHERNET; Modbus TCP



Figure: 750-352



Item Description
Version
Item No.
Order Text

Fieldbus Coupler ETHERNET; 3rd generation	
Standard	Eco
750-352	750-352/000-001
FC ETHERNET; G3	FC ETHERNET; G3; Eco

Fieldbus Coupler Modbus TCP; 4th generation	
Standard	
750-362	
FC Modbus TCP; G4	

For new installations, please consider the 750-362 Fieldbus Coupler with extended functionality.

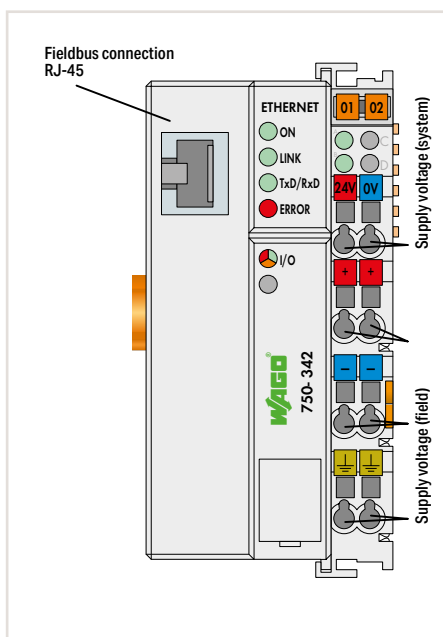
Technical Data	
Fieldbus	EtherNet/IP*; Modbus (TCP, UDP)
Protocols	HTTP; BootP; DHCP; DNS; FTP; SNMP
Connection technology: Fieldbus input/output	2 x RJ-45
Bus segment length (max.)	100 m
Baud rate	10/100 Mbit/s
Transmission medium	Twisted Pair S-UTP; 100 Ω; Cat. 5
Number of modules per node (max.)	250
Input and output (internal) process image (max.)	1020 words
Supply voltage (system)	24 VDC (-25 ... +30 %); via wiring interface
Input current (typ.) at nominal load (24 V)	280 mA
Current consumption – system supply (5 V)	450 mA
Total current (system supply)	700 mA
Surrounding air temperature (operation)	0 ... +55 °C
Dimensions W x H x D	49.5 x 71.9 x 96.8 mm
Approvals	CE; Marine; OrdLoc/HazLoc; ATEX/IECEx
Data sheet and further information, see:	wago.com/750-352

Fieldbus Coupler Modbus TCP; 4th generation	
Standard	
750-362	
FC Modbus TCP; G4	
Modbus (TCP, UDP)	
HTTP(S), BootP, DHCP, DNS, (S)FTP, SNMP	
RJ-45	
100 m	
10/100 Mbit/s	
Twisted Pair S-UTP; 100 Ω; Cat. 5	
250	
1020 words	
24 VDC (-25 ... +30 %); via wiring interface	
280 mA	
350 mA	
700 mA	
0 ... +55 °C	
49.5 x 71.9 x 96.8 mm	
CE; Marine; OrdLoc*/HazLoc; ATEX/IECEx	
wago.com/750-362	

\*For variant 750-352/000-001, EtherNet/IP is activated as a standard protocol.

\*Pending

## Fieldbus Coupler ETHERNET



### Item Description

Item No.

Order Text

### Fieldbus Coupler ETHERNET; 1st generation

750-342

FC ETHERNET; G1

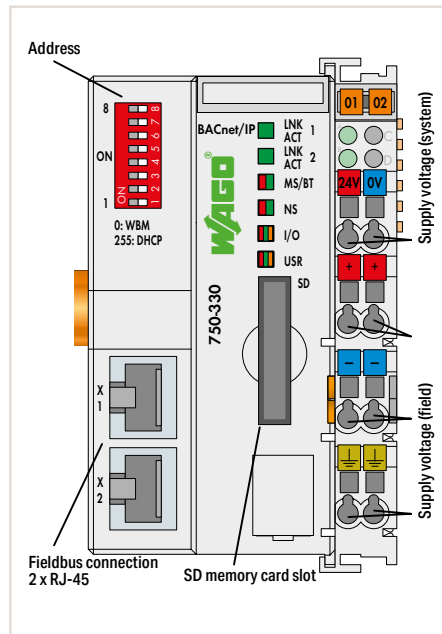
### Technical Data

Fieldbus	Modbus (TCP, UDP)
Protocols	HTTP; BootP
Connection technology: Fieldbus input/output	RJ-45
Bus segment length (max.)	100 m
Baud rate	10 Mbit/s
Transmission medium	Twisted Pair S-UTP; 100 Ω; Cat. 5
Number of modules per node (max.)	64
Input and output (internal) process image (max.)	512 bytes
Supply voltage (system)	24 VDC (-25 ... +30 %); via wiring interface (CAGE CLAMP® connection)
Supply voltage (field)	24 VDC (-25 ... +30 %); via power jumper contacts
Input current (typ.) at nominal load (24 V)	500 mA
Current consumption – system supply (5 V)	200 mA
Total current (system supply)	1800 mA
Surrounding air temperature (operation)	0 ... +55 °C
Dimensions W x H x D	50.5 x 71.1 x 100 mm
Approvals	CE; Marine; OrdLoc/HazLoc; ATEX/IECEX
Data sheet and further information, see:	<a href="http://wago.com/750-342">wago.com/750-342</a>

„ Mini-WSB marker card and mounting accessories, see Section “Accessories and Tools”

„ Approvals and corresponding ratings, see page 517 or [www.wago.com](http://www.wago.com)

## Fieldbus Coupler BACnet/IP



### Item Description

Item No.

Order Text

### Fieldbus Coupler BACnet/IP

750-330

FC BACnet/IP

### Technical Data

Fieldbus	BACnet/IP; Modbus (TCP, UDP)
Protocols	HTTPS; BootP; DHCP; DNS; FTP; SNMP
Connection technology: Fieldbus input/output	2 x RJ-45
Transmission medium	Twisted Pair S-UTP; 100 Ω; Cat. 5; Line length (max.): 100 m
Baud rate	10/100 Mbit/s
Transmission performance	Class D per EN 50173
Type of memory card	SD and SDHC to 32 GB*
BACnet device profile	B-BC (BACnet Building Controller)
BACnet revision	1.12
Number of modules per node (max.)	99
Supply voltage (system)	24 VDC (-25 ... +30 %); via wiring interface (CAGE CLAMP® connection)
Supply voltage (field)	24 VDC (-25 ... +30 %); via power jumper contacts
Input current (typ.) at nominal load (24 V)	500 mA
Current consumption – system supply (5 V)	450 mA
Total current (system supply)	1700 mA
Surrounding air temperature (operation)	0 ... +55 °C
Dimensions W x H x D	61.5 x 71.9 x 100 mm
Approvals	CE;
Data sheet and further information, see:	<a href="http://wago.com/750-330">wago.com/750-330</a>

### Accessories

SD memory card, 2 GB  
BACnet Configurator

Item No.	Page
758-879/000-001	470
Download	See Section 2

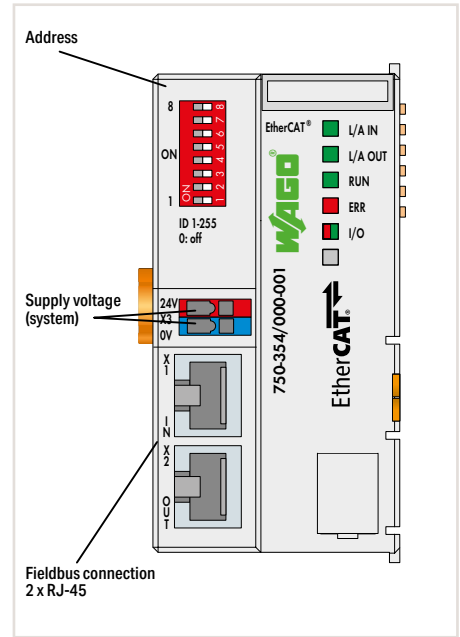
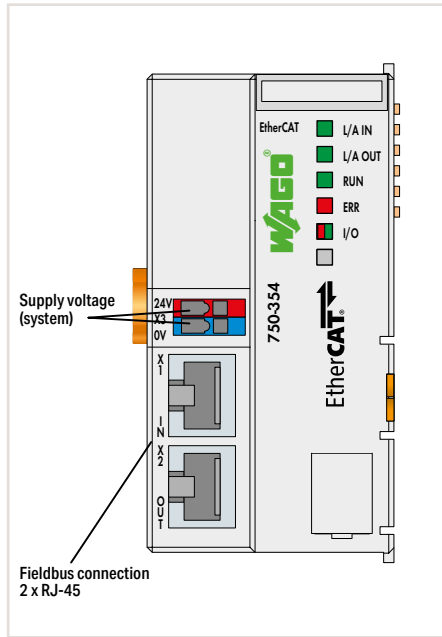
\*All guaranteed specifications are only valid with the WAGO Memory Card listed as an accessory.

# Fieldbus Coupler EtherCAT®



Figure: 750-354

Figure: 750-354/000-001



<b>Item Description</b>
<b>Version</b>
<b>Item No.</b>
<b>Order Text</b>

<b>Fieldbus Coupler EtherCAT</b>
<b>Standard</b>
<b>750-354</b>
<b>FC EtherCAT</b>

<b>Fieldbus Coupler EtherCAT</b>
<b>ID Switch</b>
<b>750-354/000-001</b>
<b>FC EtherCAT; ID Switch</b>
<b>ID Switch; Diagnostics</b>
<b>750-354/000-002</b>
<b>FC EtherCAT; ID Switch; Diagn</b>

<b>Technical Data</b>
Fieldbus
Protocols
Connection technology: Fieldbus input/output
Baud rate
Transmission medium
Number of modules per node (max.)
Input and output (internal) process image (max.)
Supply voltage (system)
Input current (typ.) at nominal load (24 V)
Current consumption – system supply (5 V)
Total current (system supply)
Surrounding air temperature (operation)
Dimensions W x H x D
<b>Approvals</b>
<b>Data sheet and further information, see:</b>

EtherCAT
EtherCAT (direct mode)
2 x RJ-45
100 Mbit/s
Shielded Twisted Pair S/FTP, F/FTP or SF/FTP; 100 Ω; Cat. 6
64
1024 bytes
24 VDC (-25 ... +30 %); via wiring interface
250 mA
300 mA
700 mA
0 ... +55 °C
49.5 x 71.9 x 96.8 mm
CE;  OrdLoc/HazLoc;  ATEX/IECEx
<a href="http://wago.com/750-354">wago.com/750-354</a>

EtherCAT
EtherCAT (direct mode)
2 x RJ-45
100 Mbit/s
Shielded Twisted Pair S/FTP, F/FTP or SF/FTP; 100 Ω; Cat. 6
64
1024 bytes
24 VDC (-25 ... +30 %); via wiring interface
250 mA
300 mA
700 mA
0 ... +55 °C
49.5 x 71.9 x 96.8 mm
CE;  OrdLoc/HazLoc;  ATEX/IECEx
Marine
<a href="http://wago.com/750-354/000-001">wago.com/750-354/000-001</a>

EtherCAT® is a registered trademark and patented technology of Beckhoff Automation GmbH.

„ Mini-WSB marker card and mounting accessories, see Section "Accessories and Tools"  
 „ Approvals and corresponding ratings, see page 517 or [www.wago.com](http://www.wago.com)

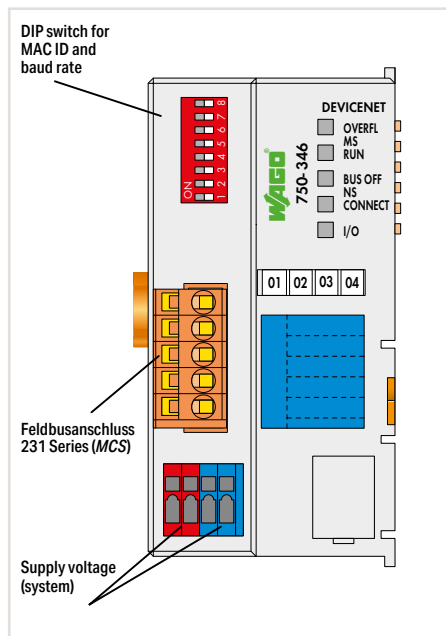
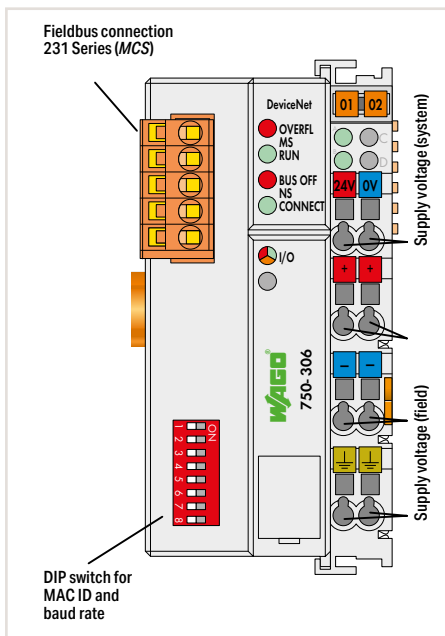
# Fieldbus Coupler DeviceNet®



Figure: 750-306



Figure: 750-346



<b>Item Description</b>
<b>Version</b>
<b>Item No.</b>
<b>Order Text</b>

<b>Fieldbus Coupler DeviceNet®</b>
<b>Standard</b>
<b>750-306</b>
<b>FC DeviceNet®</b>

<b>Fieldbus Coupler DeviceNet®</b>
<b>Eco</b>
<b>750-346</b>
<b>FC DeviceNet®, Eco</b>

Technical Data	
Fieldbus	
Connection technology: Fieldbus input/output	
Number of fieldbus nodes on master (max.)	
Number of I/O points	
Baud rate	
Transmission medium	
Number of modules per node (max.)	
Input and output (internal) process image (max.)	
Supply voltage (system)	
Supply voltage (field)	
Input current (typ.) at nominal load (24 V)	
Input current via DeviceNet interface at 11 V	
Current consumption – system supply (5 V)	
Total current (system supply)	
Surrounding air temperature (operation)	
Dimensions W x H x D	
<b>Approvals</b>	
<b>Certification</b>	
<b>Data sheet and further information, see:</b>	
<b>Accessories</b>	
EDS files	

DeviceNet®
5-pole male connector
64 with scanner
Approx. 6000 (dependent on master)
125 kBd; 250 kBd; 500 kBd
Shielded Cu cable; Remote bus cable: 2 x 0.82 mm <sup>2</sup> + 2 x 1.7 mm <sup>2</sup> ; Drop cable: 2 x 0.2 mm <sup>2</sup> + 2 x 0.32 mm <sup>2</sup>
64
512 bytes
24 VDC (-25 ... +30 %); via wiring interface (CAGE CLAMP® connection)
24 VDC (-25 ... +30 %); via power jumper contacts
500 mA
120 mA
350 mA
1650 mA
0 ... +55 °C
50.5 x 71.1 x 100 mm
CE;  Marine;  OrdLoc/HazLoc; ATEX/IECEX
ODVA
<a href="http://wago.com/750-306">wago.com/750-306</a>
<b>Item No.</b>
Download: <a href="http://www.wago.com">www.wago.com</a>

DeviceNet®
5-pole male connector
64 with scanner
Approx. 6000 (dependent on master)
125 kBd; 250 kBd; 500 kBd
Shielded Cu cable; Remote bus cable: 2 x 0.82 mm <sup>2</sup> + 2 x 1.7 mm <sup>2</sup> ; Drop cable: 2 x 0.2 mm <sup>2</sup> + 2 x 0.32 mm <sup>2</sup>
64
32 bytes
24 VDC (-15 ... +20 %); via wiring interface
260 mA
120 mA
350 mA
650 mA
0 ... +55 °C
49.5 x 71.9 x 96.8 mm
CE;  Marine;  OrdLoc/HazLoc;  ATEX/IECEX
<a href="http://wago.com/750-346">wago.com/750-346</a>
<b>Item No.</b>
Download: <a href="http://www.wago.com">www.wago.com</a>

# Fieldbus Coupler CANopen



Figure: 750-337

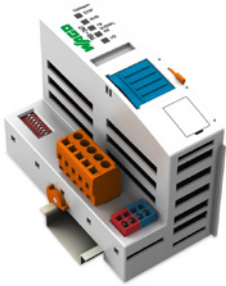
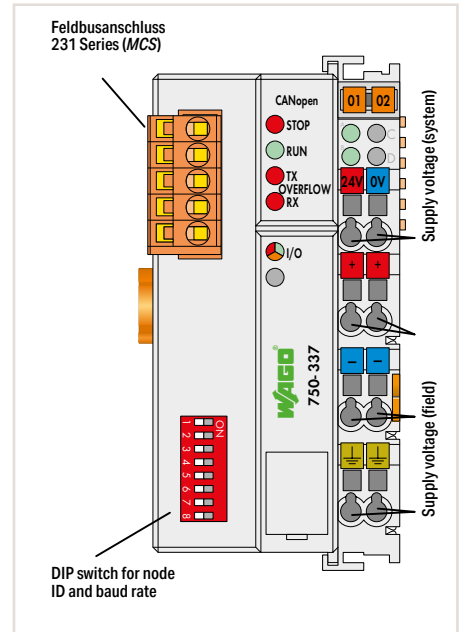
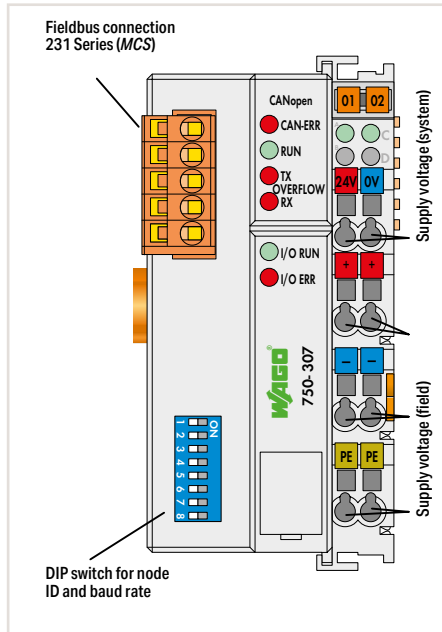


Figure: 750-347



<b>Item Description</b>
<b>Version</b>
<b>Item No.</b>
<b>Order Text</b>

<b>Fieldbus Coupler CANopen</b>
<b>Standard</b>
750-307
FC CANopen

<b>Fieldbus Coupler CANopen MCS</b>
<b>Standard</b>
750-337
FC CANopen; MCS
<b>Extended Temperature</b>
750-337/025-000
FC CANopen; MCS; T

<b>Technical Data</b>
<b>Fieldbus</b>
Connection technology: Fieldbus input/output
Number of fieldbus nodes on master (max.)
Bus segment length (max.)
Transmission medium
Baud rate
Number of modules per node (max.)
Input and output (internal) process image (max.)
Number of PDOs
Number of SDOs
Communication profile
Device profile

CANopen
5-pole male connector
110
30 ... 1000 m (depends on baud rate/cable)
Shielded Cu cable 3 x 0.25 mm <sup>2</sup>
10 kBd ... 1 MBd
64
512 bytes
5 Tx / 5 Rx
2 SDO servers
DS-301 V3.0
DS-401 V1.4

CANopen
5-pole male connector
110
30 ... 1000 m (depends on baud rate/cable)
Shielded Cu cable 3 x 0.25 mm <sup>2</sup>
10 kBd ... 1 MBd
64
512 bytes
32 Tx / 32 Rx
2 SDO servers
DS-301 V4.01
DS-401 V2.0;

Additional functions: limit monitoring; flank-triggered PDOs; configurable response in the event of an error

Supply voltage (system)
Supply voltage (field)
Input current (typ.) at nominal load (24 V)
Current consumption – system supply (5 V)
Total current (system supply)
Surrounding air temperature (operation)
Dimensions W x H x D

24 VDC (-15 ... +20 %); via wiring interface (CAGE CLAMP® connection)
24 VDC (-15 ... +20 %); via power jumper contacts
500 mA
350 mA
1650 mA
0 ... +55 °C
50.5 x 71.1 x 100 mm

24 VDC (-25 ... +30 %); via wiring interface (CAGE CLAMP® connection)
24 VDC (-25 ... +30 %); via power jumper contacts
500 mA
350 mA
1650 mA
0 ... +55 °C
-20 ... +60 °C
50.5 x 71.1 x 100 mm

<b>Approvals</b>
<b>Data sheet and further information, see:</b>

CE; OrdLoc/HazLoc; ATEX/IECEX
<a href="http://wago.com/750-307">wago.com/750-307</a>

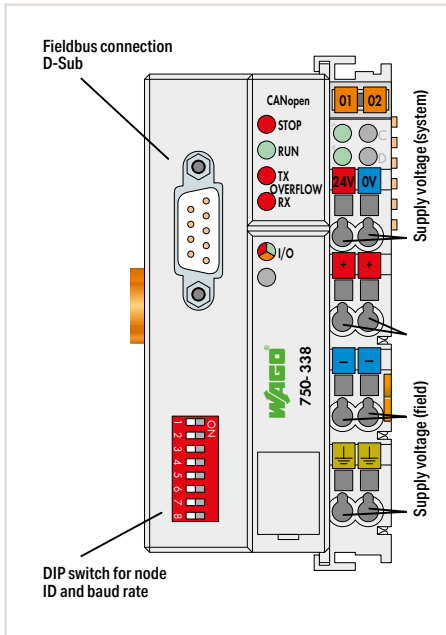
CE; Marine; OrdLoc/HazLoc; ATEX/IECEX
<a href="http://wago.com/750-337">wago.com/750-337</a>

<b>Accessories</b>
EDS files

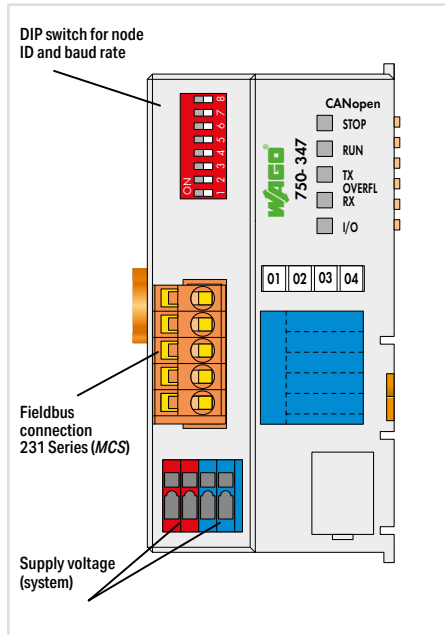
<b>Item No.</b>
Download: <a href="http://www.wago.com">www.wago.com</a>

<b>Item No.</b>
Download: <a href="http://www.wago.com">www.wago.com</a>

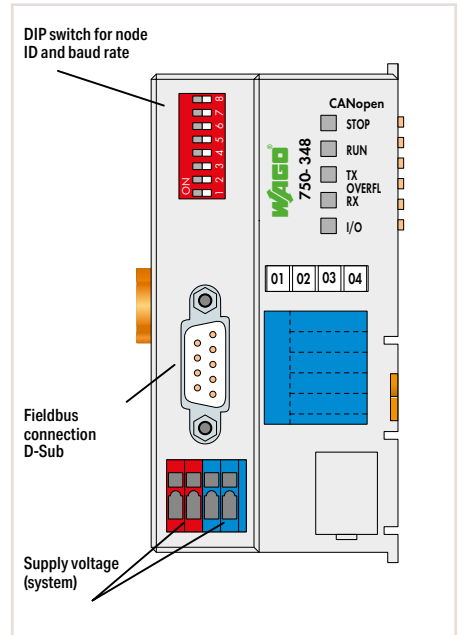
„ Mini-WSB marker card and mounting accessories, see Section "Accessories and Tools"  
 „ Approvals and corresponding ratings, see page 517 or [www.wago.com](http://www.wago.com)



**Fieldbus Coupler CANopen D-Sub**  
**Standard**  
 750-338  
 FC CANopen; DSub



**Fieldbus Coupler CANopen MCS**  
**Eco**  
 750-347  
 FC CANopen; MCS; Eco



**Fieldbus Coupler CANopen D-Sub**  
**Eco**  
 750-348  
 FC CANopen; DSub; Eco

CANopen
Plug D-Sub 9
110
30 ... 1000 m (depends on baud rate/cable)
Shielded Cu cable 3 x 0.25 mm <sup>2</sup>
10 kBd ... 1 MBd
64
512 bytes
32 Tx / 32 Rx
2 SDO servers
DS-301 V4.01
DS-401 V2.0;
Additional functions: limit monitoring; flank-triggered PDOs; configurable response in the event of an error
24 VDC (-25 ... +30 %); via wiring interface (CAGE CLAMP® connection)
24 VDC (-25 ... +30 %); via power jumper contacts
500 mA
350 mA
1650 mA
0 ... +55 °C
50.5 x 71.1 x 100 mm
CE; Marine; OrdLoc/HazLoc; ATEX/IECEx
wago.com/750-338

**Item No.**  
 Download: www.wago.com

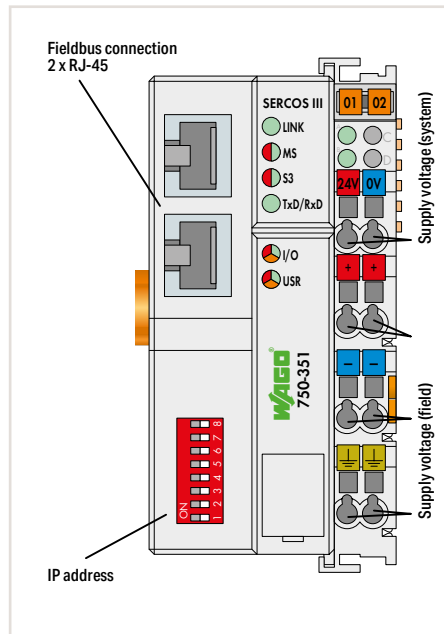
CANopen
5-pole male connector
110
30 ... 1000 m (depends on baud rate/cable)
Shielded Cu cable 3 x 0.25 mm <sup>2</sup>
10 kBd ... 1 MBd
64
32 bytes
5 Tx / 5 Rx
1 SDO server
DS-301 V4.01
DS-401 V2.0;
Additional functions: configurable response in the event of an error
24 VDC (-25 ... +30 %); via wiring interface
260 mA
350 mA
650 mA
0 ... +55 °C
49.5 x 71.9 x 96.8 mm
CE; Marine; OrdLoc/HazLoc; ATEX/IECEx
wago.com/750-347

**Item No.**  
 Download: www.wago.com

CANopen
Plug D-Sub 9
110
30 ... 1000 m (depends on baud rate/cable)
Shielded Cu cable 3 x 0.25 mm <sup>2</sup>
10 kBd ... 1 MBd
64
32 bytes
5 Tx / 5 Rx
1 SDO server
DS-301 V4.01
DS-401 V2.0;
Additional functions: configurable response in the event of an error
24 VDC (-25 ... +30 %); via wiring interface
260 mA
350 mA
650 mA
0 ... +55 °C
49.5 x 71.9 x 96.8 mm
CE; Marine; OrdLoc/HazLoc; ATEX/IECEx
wago.com/750-348

**Item No.**  
 Download: www.wago.com

## Fieldbus Coupler Sercos®



### Item Description

Item No.

Order Text

### Technical Data

Fieldbus

Protocols

Supported services

Connection technology: Fieldbus input/output

Sercos® version

IO profile

Number of couplers (slaves) in Sercos® ring

Baud rate

Transmission medium

Number of modules per node (max.)

Input and output (internal) process image (max.)

Supply voltage (system)

Supply voltage (field)

Input current (typ.) at nominal load (24 V)

Current consumption – system supply (5 V)

Total current (system supply)

Surrounding air temperature (operation)

Dimensions W x H x D

### Approvals

Data sheet and further information, see:

### Fieldbus Coupler Sercos®

750-351

FC Sercos®

Sercos®

Sercos; FSP-IO; TCP/IP; FTP; HTTP; BootP; DHCP; SNTP

SVC; RTC; CC; IP;  
Ring break (GDP\_Basic; SCP\_VarCFG; SCP\_Sync)

2 x RJ-45

V1.1.1

V1.1.1

512

100 Mbit/s; Full duplex

Twisted Pair S-UTP; 100 Ω; Cat. 5

250

2 KB (RTC and SVC)

24 VDC (-25 ... +30 %); via wiring interface (CAGE CLAMP® connection)

24 VDC (-25 ... +30 %); via power jumper contacts

500 mA

300 mA

1700 mA

0 ... +55 °C

50.5 x 71.1 x 100 mm

CE; Marine; OrdLoc/HazLoc;

ATEX/IECEX

[wago.com/750-351](http://wago.com/750-351)

„ Mini-WSB marker card and mounting accessories, see Section "Accessories and Tools"

„ Approvals and corresponding ratings, see page 517 or [www.wago.com](http://www.wago.com)



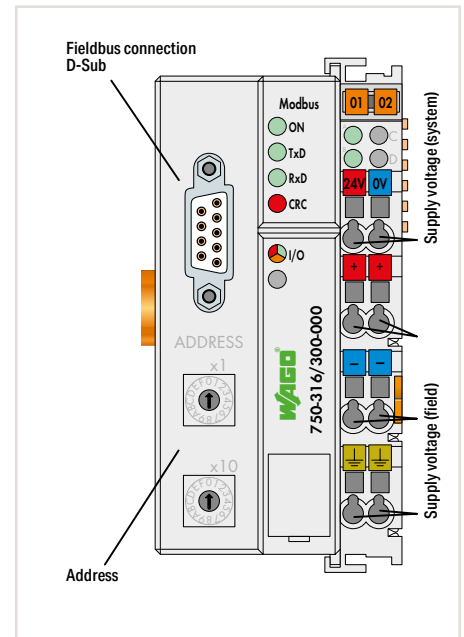
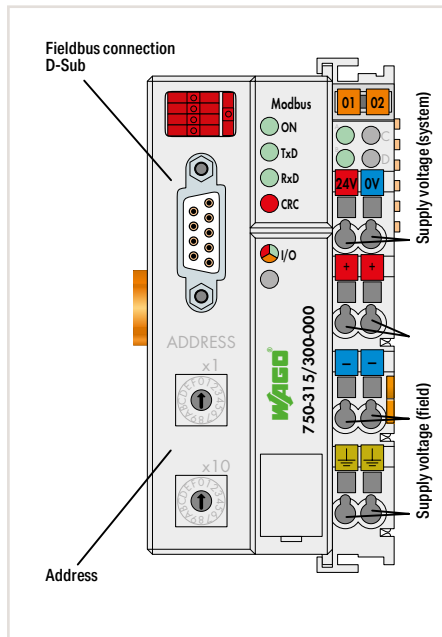
# Fieldbus Coupler Modbus®



Figure: 750-315/300-000



Figure: 750-316/300-000



<b>Item Description</b>
<b>Version</b>
<b>Item No.</b>
<b>Order Text</b>

<b>Fieldbus Coupler Modbus®</b>
<b>RS-485; 115.2 kBd</b>
<b>750-315/300-000</b>
<b>FC Modbus; RS485; 115.2kBd</b>

<b>Fieldbus Coupler Modbus®</b>
<b>RS-232; 115.2 kBd</b>
<b>750-316/300-000</b>
<b>FC Modbus; RS232; 115.2kBd</b>

<b>Technical Data</b>
Fieldbus
Connection technology: Fieldbus input/output
Number of fieldbus nodes on master (max.)
Interface standard
Baud rate
Transmission medium
Number of modules per node (max.)
Input and output (internal) process image (max.)
Supply voltage (system)
Supply voltage (field)
Input current (typ.) at nominal load (24 V)
Current consumption – system supply (5 V)
Total current (system supply)
Surrounding air temperature (operation)
Dimensions W x H x D

Modbus®
Socket D-Sub 9
247 with repeater
RS-485
150 Bd ... 115.2 KBd
Shielded Cu cable 2 (4) x 0.25 mm²
64
512 bytes
24 VDC (-25 ... +30 %); via wiring interface (CAGE CLAMP® connection)
24 VDC (-25 ... +30 %); via power jumper contacts
500 mA
350 mA
1650 mA
0 ... +55 °C
50.5 x 71.1 x 100 mm

Modbus®
Socket D-Sub 9
247 with repeater
RS-232
150 Bd ... 115.2 KBd
Shielded Cu cable 2 (4) x 0.25 mm²
64
512 bytes
24 VDC (-25 ... +30 %); via wiring interface (CAGE CLAMP® connection)
24 VDC (-25 ... +30 %); via power jumper contacts
500 mA
350 mA
1650 mA
0 ... +55 °C
50.5 x 71.1 x 100 mm

<b>Approvals</b>
<b>Data sheet and further information, see:</b>

CE; Marine; OrdLoc/HazLoc; ATEX/IECEX
<a href="http://wago.com/750-315/300-000">wago.com/750-315/300-000</a>

CE; Marine; OrdLoc/HazLoc; ATEX/IECEX
<a href="http://wago.com/750-316/300-000">wago.com/750-316/300-000</a>

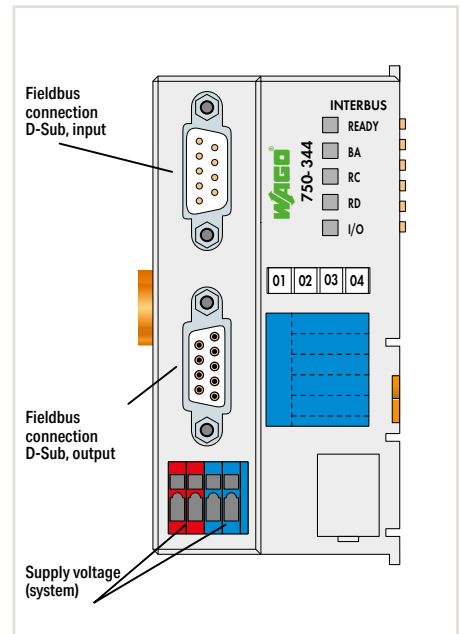
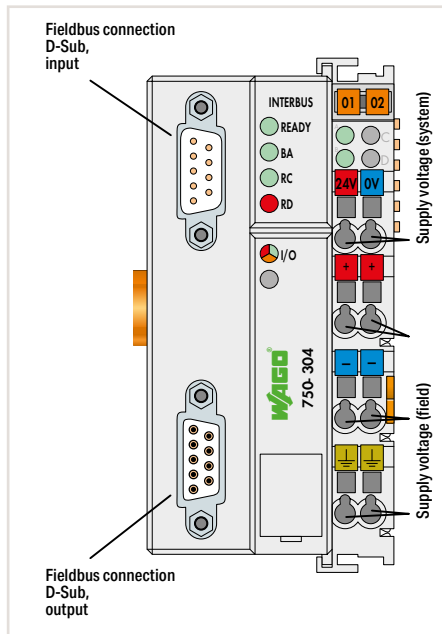
# Fieldbus Coupler INTERBUS



Figure: 750-304



Figure: 750-344



<b>Item Description</b>
<b>Item No.</b>
<b>Order Text</b>

<b>Fieldbus Coupler INTERBUS</b>
<b>750-304</b>
<b>FC INTERBUS</b>

<b>Fieldbus Coupler INTERBUS; 500 kBit/s; Eco</b>
<b>750-344</b>
<b>FC INTERBUS; 500kbit/s; Eco</b>

Technical Data	
Fieldbus	INTERBUS
Connection technology: Fieldbus input/output	D-Sub 9 plug / D-Sub 9 socket
Number of fieldbus nodes on master (max.)	256
Bus segment length (max.)	400 m
Transmission medium	Copper cable
Baud rate	500 kBd
Number of modules per node (max.)	64
Input and output (internal) process image (max.)	64 bytes
Supply voltage (system)	24 VDC (-15 ... +20 %); via wiring interface (CAGE CLAMP® connection)
Supply voltage (field)	24 VDC (-15 ... +20 %); via power jumper contacts
Input current (typ.) at nominal load (24 V)	500 mA
Current consumption – system supply (5 V)	300 mA
Total current (system supply)	1700 mA
Surrounding air temperature (operation)	0 ... +55 °C
Dimensions W x H x D	50.5 x 71.1 x 100 mm
Approvals	CE; OrdLoc/HazLoc; ATEX/IECEX
Standard	EN 50254
Certification	INTERBUS CLUB
Data sheet and further information, see:	<a href="http://wago.com/750-304">wago.com/750-304</a>

Technical Data	
Fieldbus	INTERBUS
Connection technology: Fieldbus input/output	D-Sub 9 plug / D-Sub 9 socket
Number of fieldbus nodes on master (max.)	256
Bus segment length (max.)	400 m
Transmission medium	Copper cable
Baud rate	500 kBd
Number of modules per node (max.)	64
Input and output (internal) process image (max.)	20 bytes
Supply voltage (system)	24 VDC (-15 ... +20 %); via wiring interface
Supply voltage (field)	24 VDC (-15 ... +20 %); via power jumper contacts
Input current (typ.) at nominal load (24 V)	260 mA
Current consumption – system supply (5 V)	350 mA
Total current (system supply)	650 mA
Surrounding air temperature (operation)	0 ... +55 °C
Dimensions W x H x D	49.5 x 71.9 x 96.8 mm
Approvals	CE; OrdLoc/HazLoc; ATEX/IECEX
Standard	EN 50254
Certification	INTERBUS CLUB
Data sheet and further information, see:	<a href="http://wago.com/750-344">wago.com/750-344</a>

Technical Data	
Fieldbus	INTERBUS
Connection technology: Fieldbus input/output	D-Sub 9 plug / D-Sub 9 socket
Number of fieldbus nodes on master (max.)	256
Bus segment length (max.)	400 m
Transmission medium	Copper cable
Baud rate	500 kBd
Number of modules per node (max.)	64
Input and output (internal) process image (max.)	20 bytes
Supply voltage (system)	24 VDC (-15 ... +20 %); via wiring interface
Supply voltage (field)	24 VDC (-15 ... +20 %); via power jumper contacts
Input current (typ.) at nominal load (24 V)	260 mA
Current consumption – system supply (5 V)	350 mA
Total current (system supply)	650 mA
Surrounding air temperature (operation)	0 ... +55 °C
Dimensions W x H x D	49.5 x 71.9 x 96.8 mm
Approvals	CE; OrdLoc/HazLoc; ATEX/IECEX
Standard	EN 50254
Certification	INTERBUS CLUB
Data sheet and further information, see:	<a href="http://wago.com/750-344">wago.com/750-344</a>

<b>Accessories</b>
INTERBUS files

<b>Item No.</b>
Download: <a href="http://www.wago.com">www.wago.com</a>

<b>Item No.</b>
Download: <a href="http://www.wago.com">www.wago.com</a>

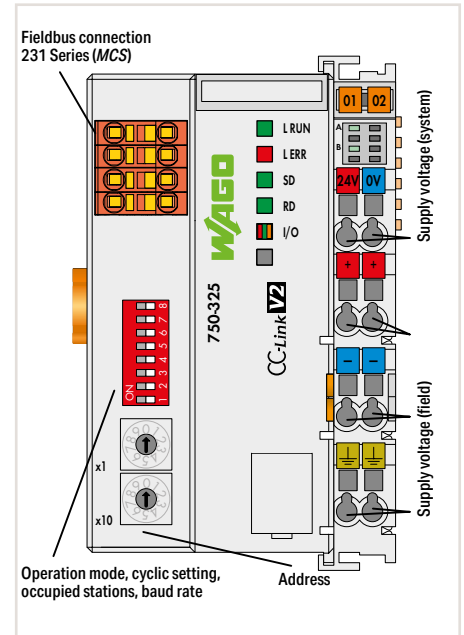
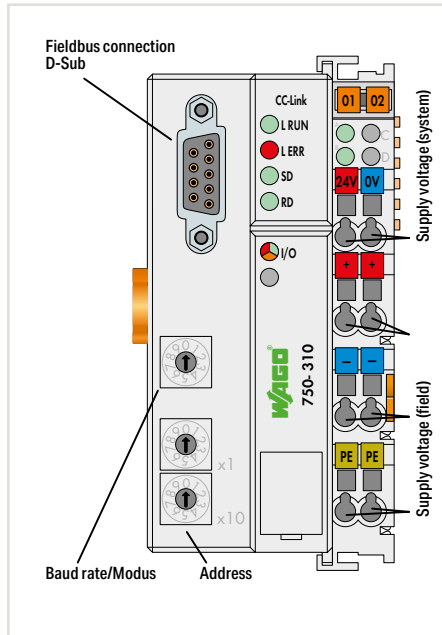
„ Mini-WSB marker card and mounting accessories, see Section "Accessories and Tools"  
 „ Approvals and corresponding ratings, see page 517 or [www.wago.com](http://www.wago.com)

# Fieldbus Coupler CC-Link



Figure: 750-310

Figure: 750-325



Item Description	Fieldbus Coupler CC-Link	Fieldbus Coupler CC-Link
Item No.	750-310	750-325
Order Text	FC CC-Link	FC CC-Link
<b>Technical Data</b>		
Fieldbus	CC-Link	CC-Link
Connection technology: Fieldbus input/output	Socket D-Sub 9	MCS pluggable connectors (included)
Number of fieldbus nodes on master (max.)	64	64
Baud rate	156 kBd ... 10 MBd	156 kBd ... 10 MBd
Transmission medium	Shielded Cu cable 2/3 x 0.5 mm <sup>2</sup>	Shielded Cu cable 2/3 x 0.5 mm <sup>2</sup>
Number of modules per node (max.)	64	64
Operating mode		CC-Link V2.0 (default setting)/V1.1
Assigned station addresses	4/1 ... 4	1 ... 4 / 4 (default setting)
Advanced cycle setting		1, 2, 4 (default setting); 8 cycles
Input (internal) process image (max.)	14-byte digital; 2-byte system; 32-byte analog	RX (digital inputs): V1.1: 16, 48, 80, 112 bits; V2.0: 16, 48, 80, 112 bits (1 cycle); V2.0: 16, 80, 144, 208 bits (2 cycles); V2.0: 48, 176, 304, 432 bits (4 cycles); V2.0: 112, 368, 624, 880 bits (8 cycles) and for each 16-bit system area; RW <sub>r</sub> (analog inputs): V1.1: 4, 8, 12, 16 words (16 bits); V2.0: 4, 8, 12, 16 words (1 cycle); V2.0: 8, 16, 24, 32 words (2 cycles); V2.0: 16, 32, 48, 64 words (4 cycles); V2.0: 32, 64, 96, 128 words (8 cycles)
Output (internal) process image (max.)	14-byte digital; 2-byte system; 32-byte analog	RY (digital outputs): V1.1: 16, 48, 80, 112 bits; V2.0: 16, 48, 80, 112 bits (1 cycle); V2.0: 16, 80, 144, 208 bits (2 cycles); V2.0: 48, 176, 304, 432 bits (4 cycles); V2.0: 112, 368, 624, 880 bits (8 cycles) and for each 16-bit system area RW <sub>w</sub> (analog outputs): V1.1: 4, 8, 12, 16 words (16 bits); V2.0: 4, 8, 12, 16 words (1 cycle); V2.0: 8, 16, 24, 32 words (2 cycles); V2.0: 16, 32, 48, 64 words (4 cycles); V2.0: 32, 64, 96, 128 words (8 cycles)
Supply voltage (system)	24 VDC (-25 ... +30 %); via wiring interface (CAGE CLAMP® connection)	24 VDC (-25 ... +30 %); via wiring interface (CAGE CLAMP® connection)
Supply voltage (field)	24 VDC (-25 ... +30 %); via power jumper contacts	24 VDC (-25 ... +30 %); via power jumper contacts
Input current (typ.) at nominal load (24 V)	500 mA	500 mA
Current consumption – system supply (5 V)	300 mA	200 mA
Total current (system supply)	1700 mA	1800 mA
Surrounding air temperature (operation)	0 ... +55 °C	0 ... +55 °C
Dimensions W x H x D	50.5 x 71.1 x 100 mm	61.5 x 71.9 x 100 mm
Approvals	CE, OrdLoc/HazLoc, ATEX/IECEX	CE
Data sheet and further information, see:	wago.com/750-310	wago.com/750-325

# Digital Input Modules

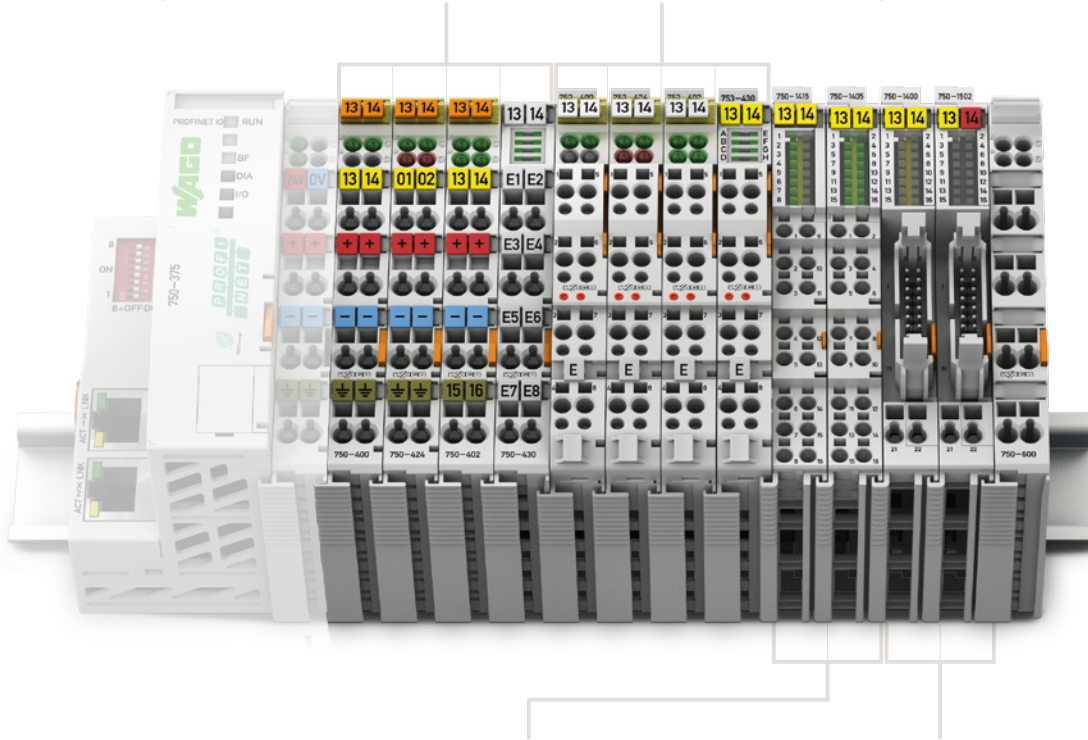


## Housing design (750 Series)

Dimensions W x H x D	Housing with 4 LEDs: 12 x 69.8 x 100 mm Housing with 8 LEDs: 12 x 67.8 x 100 mm
Height from upper-edge of DIN-rail	Housing with 4 LEDs: 62.6 mm Housing with 8 LEDs: 60.6 mm
Connection technology	CAGE CLAMP®
Conductor cross section	0.08 ... 2.5 mm <sup>2</sup> / 28 ... 14 AWG
Strip length	8 ... 9 mm / 0.33 inch

## Housing design (753 Series)

Dimensions W x H x D	Housing with 4 LEDs: 12 x 69.8 x 100 mm Housing with 8 LEDs: 12 x 69 x 100 mm
Height from upper-edge of DIN-rail	Housing with 4 LEDs: 62.6 mm Housing with 8 LEDs: 61.8 mm
Connection technology	CAGE CLAMP®
Conductor cross section	0.08 ... 2.5 mm <sup>2</sup> / 28 ... 14 AWG
Strip length	9 ... 10 mm / 0.37 inch



## Housing design (750 Series), with Push-in CAGE CLAMP® connections (up to 16 connection points)

Dimensions W x H x D	12 x 69 x 100 mm
Height from upper-edge of DIN-rail	61.8 mm
Connection technology	Push-in CAGE CLAMP®
Conductor cross section	Solid: 0.08 ... 1.5 mm <sup>2</sup> / 28 ... 16 AWG Fine-stranded: 0.25 ... 1.5 mm <sup>2</sup> / 22 ... 16 AWG
Strip length	8 ... 9 mm / 0.33 inch

## Housing design (750 Series), with ribbon cable connection

Dimensions W x H x D	12 x 74.1 x 100 mm
Height from upper-edge of DIN-rail	66.9 mm
Connection technology	20-pole male connector + 2 x CAGE CLAMP®
Conductor cross section	0.08 ... 2.5 mm <sup>2</sup> / 28 ... 14 AWG
Strip length	8 ... 9 mm / 0.33 inch



I/O System –  
750 XTR Series

# I/O System – 750 and 753 Series, Digital Input Modules

## Contents

Function	2-Channel DI	4-Channel DI	8-Channel DI	16-Channel DI	8-Channel DIO	Description	Item Number			Page	
							Standard	Extended Temperature	Pluggable		
5 VDC		<input type="checkbox"/>				4-Channel Digital Input; 5 VDC; 0.2 ms	750-414			164	
5/12 VDC			<input type="checkbox"/>			8-Channel Digital Input; 5/12 VDC; 0.2 ms			753-434	164	
24 VDC	<input type="checkbox"/>					2-Channel Digital Input; 24 VDC; 3 ms	750-400	750-400/025-000	753-400	165	
	<input type="checkbox"/>					2-Channel Digital Input; 24 VDC; 3 ms; Acknowledgement; Diagnostics	750-418		753-418	165	
	<input type="checkbox"/>					2-Channel Digital Input; 24 VDC; 3 ms; Diagnostics	750-421		753-421	166	
	<input type="checkbox"/>					4-Channel Digital Input; 24 VDC; 3 ms	750-402	750-402/025-000	753-402	166	
	<input type="checkbox"/>					4-Channel Digital Input; 24 VDC; 3 ms; 2-wire connection	750-432		753-432	167	
	<input type="checkbox"/>					4-Channel Digital Input; 24 VDC; 3 ms; 3-wire connection	750-1420			167	
	<input type="checkbox"/>			<input type="checkbox"/>		8-Channel Digital Input; 24 VDC; 3 ms	750-430*	750-430/025-000	753-430	168	
	<input type="checkbox"/>			<input type="checkbox"/>		8-Channel Digital Input; 24 VDC; 3 ms; 2-wire connection	750-1415*			168	
	<input type="checkbox"/>				<input type="checkbox"/>	16-Channel Digital Input; 24 VDC; 3 ms; Ribbon cable	750-1400			169	
	<input type="checkbox"/>				<input type="checkbox"/>	16-Channel Digital Input; 24 VDC; 3 ms	750-1405*			169	
	<input type="checkbox"/>				<input type="checkbox"/>	8-Channel Digital Input/Output; 24 VDC; 0.5 A; Ribbon cable	750-1502			170	
	<input type="checkbox"/>				<input type="checkbox"/>	8-Channel Digital Input/Output; 24 VDC; 0.5 A	750-1506			170	
	3 ms; High-side switching	<input type="checkbox"/>					2-Channel Digital Input; 24 VDC; 0.2 ms	750-401		753-401	171
		<input type="checkbox"/>					4-Channel Digital Input; 24 VDC; 0.2 ms	750-403		753-403	171
		<input type="checkbox"/>					4-Channel Digital Input; 24 VDC; 0.2 ms; 2-wire connection	750-433		753-433	172
		<input type="checkbox"/>					4-Channel Digital Input; 24 VDC; 0.2 ms; 3-wire connection	750-1421			172
<input type="checkbox"/>				<input type="checkbox"/>		8-Channel Digital Input; 24 VDC; 0.2 ms	750-431*		753-431	173	
0.2 ms; High-side switching	<input type="checkbox"/>					8-Channel Digital Input; 24 VDC; 0.2 ms; 2-wire connection	750-1416*			173	
	<input type="checkbox"/>			<input type="checkbox"/>		16-Channel Digital Input; 24 VDC; 0.2 ms	750-1406			173	
3 ms; Low-side switching	<input type="checkbox"/>					4-Channel Digital Input; 24 VDC; 3 ms; Low-side switching	750-408	750-408/025-000	753-408	174	
	<input type="checkbox"/>					4-Channel Digital Input; 24 VDC; 3 ms; Low-side switching; 3-wire connection	750-1422			174	
	<input type="checkbox"/>			<input type="checkbox"/>		8-Channel Digital Input; 24 VDC; 3 ms; Low-side switching	750-436		753-436	175	
	<input type="checkbox"/>			<input type="checkbox"/>		8-Channel Digital Input; 24 VDC; 3 ms; Low-side switching; 2-wire connection	750-1417			175	
	<input type="checkbox"/>				<input type="checkbox"/>	16-Channel Digital Input; 24 VDC; 3 ms; Low-side switching; Ribbon cable	750-1402			176	
	<input type="checkbox"/>				<input type="checkbox"/>	16-Channel Digital Input; 24 VDC; 3 ms; Low-side switching	750-1407			176	
0.2 ms; Low-side switching	<input type="checkbox"/>					4-Channel Digital Input; 24 VDC; 0.2 ms; Low-side switching	750-409		753-409	177	
	<input type="checkbox"/>					4-Channel Digital Input; 24 VDC; 0.2 ms; Low-side switching; 3-wire connection	750-1423			177	
	<input type="checkbox"/>			<input type="checkbox"/>		8-Channel Digital Input; 24 VDC; 0.2 ms; Low-side switching	750-437		753-437	178	
	<input type="checkbox"/>			<input type="checkbox"/>		8-Channel Digital Input; 24 VDC; 0.2 ms; Low-side switching; 2-wire connection	750-1418			178	
	<input type="checkbox"/>					2-Channel Digital Input; 24 VDC; 3 ms; Proximity sensor	750-410		753-410	179	
	<input type="checkbox"/>					2-Channel Digital Input; 24 VDC; 0.2 ms; Proximity sensor	750-411		753-411	179	
	<input type="checkbox"/>					2-Channel Digital Input; NAMUR	750-425		753-425	180	
	<input type="checkbox"/>					2-Channel Digital Input; Intruder detection	750-424		753-424	181	
	<input type="checkbox"/>					4-Channel Digital Input; 24 VDC; Pulse extension	750-422		753-422	182	
24 VAC/DC	<input type="checkbox"/>					4-Channel Digital Input; 24 VAC/DC; 20 ms	750-415		753-415	183	
	<input type="checkbox"/>					4-Channel Digital Input; 24 VAC/DC; 50 ms	750-423		753-423	183	
42 VAC/VDC	<input type="checkbox"/>					4-Channel Digital Input; 24 VAC/DC; 20 ms	750-428		753-428	184	
48 VDC	<input type="checkbox"/>					2-Channel Digital Input; 48 VDC; 3 ms	750-412		753-412	185	
60 VDC	<input type="checkbox"/>					2-Channel Digital Input; 60 VDC; 3 ms	*		753-429	186	
110 VDC	<input type="checkbox"/>					2-Channel Digital Input; 110 VDC; High-side/low-side switching	750-427*		753-427	187	
220 VDC	<input type="checkbox"/>					2-Channel Digital Input; 220 VDC	750-407*			187	
120 VAC	<input type="checkbox"/>					2-Channel Digital Input; 120 VAC	750-406		753-406	188	
120/230 VAC	<input type="checkbox"/>			<input type="checkbox"/>		4-Channel Digital Input; 120/230 VAC			753-440	189	
230 VAC	<input type="checkbox"/>					2-Channel Digital Input; 230 VAC	750-405		753-405	188	
PTC			<input type="checkbox"/>			8-Channel Digital Input; PTC	750-1425			189	
<b>Functional Safety</b>							See Section 5.8				
<b>Ex i</b>							See Section 5.9				
<b>*This module is also available as a 750 XTR Series variant.</b>							See Section 6				

## Digital Input; 5 (12) VDC; 0.2 ms



Figure: 750-414

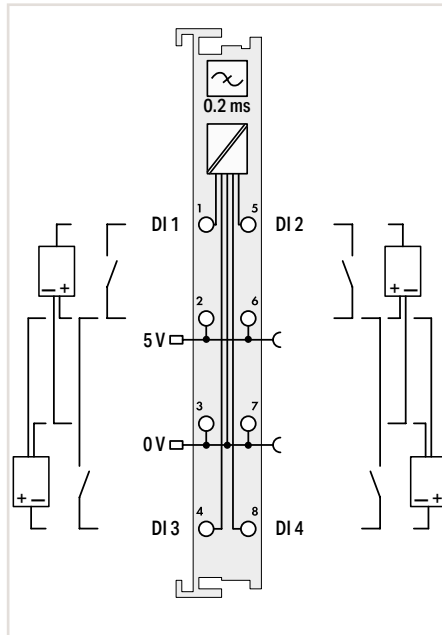
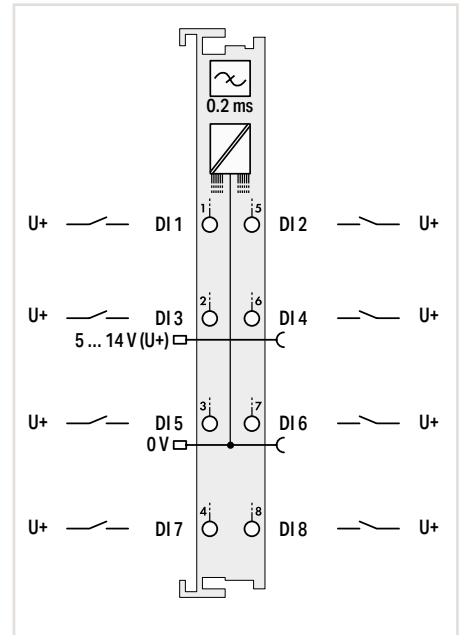


Figure: 753-434



Item Description	4-Channel Digital Input; 5 VDC; 0.2 ms	8-Channel Digital Input; 5/12 VDC; 0.2 ms
Version	Standard	Pluggable (delivery without connector)
Item No.	750-414	753-434
Order Text	4DI; 5 VDC; 0.2ms	8DI; 5/12 VDC; 0.2ms
<b>Technical Data</b>		
Pluggable connector		●
Number of digital inputs	4	8
Signal type	5 VDC	5 ... 14 VDC
Voltage range for signal (0)	0 ... 0.8 VDC	-3 VDC ... 0.2 x U <sub>V</sub>
Voltage range for signal (1)	2.4 ... 5 VDC	0.5 U <sub>V</sub> ... 1.1 U <sub>V</sub> DC
Sensor connection	2 x (2-wire; 3-wire)*	1-wire
Input characteristic	High-side switching	High-side switching
Input filter (digital)	0.2 ms	0.2 ms
Input current per channel for signal (1) typ.	0.05 mA	0.06 mA
Supply voltage (sensor)	5 VDC	
Supply voltage (field)	5 VDC; via power jumper contacts (power supply via blade contact; transmission via spring contact)	5 ... 14 VDC (-15 ... +20 %); via power jumper contacts (power supply via blade contact; transmission via spring contact)
Current consumption – system supply (5 V)	5 mA	4 mA
Data width (internal)	4 bits	8 bits
Isolation	500 V system/field	500 V system/field
Surrounding air temperature (operation)	0 ... +55 °C	0 ... +55 °C
Dimensions W x H x D	12 x 69.8 x 100 mm	12 x 69 x 100 mm
Approvals	CE, UL, OrdLoc/HazLoc	CE, UL, Marine, OrdLoc/HazLoc; ATEX/IECEx
Data sheet and further information, see:	<a href="http://wago.com/750-414">wago.com/750-414</a>	<a href="http://wago.com/753-434">wago.com/753-434</a>
<b>Accessories</b>		
Pluggable connector		Item No. 753-110
Coding keys		753-150

Notice:  
An additional supply module must be added for operation with 5 VDC!

\*A suitable field side connection module (e.g., 750-614) must also be used to connect other sensors.

Notice:  
An additional supply module must be added for 5–14 VDC supply!

„ Mini-WSB marker card and mounting accessories, see Section “Accessories and Tools”

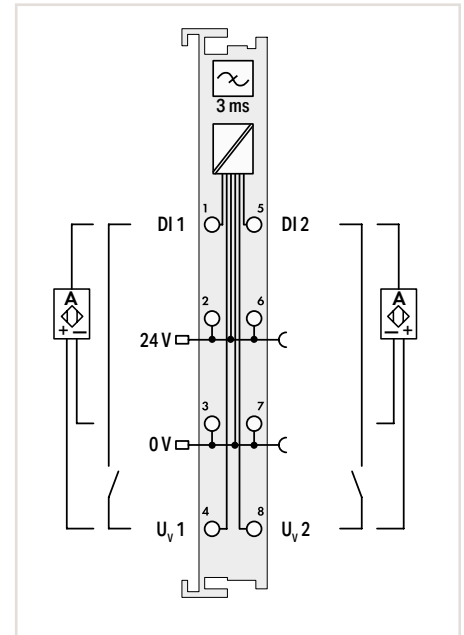
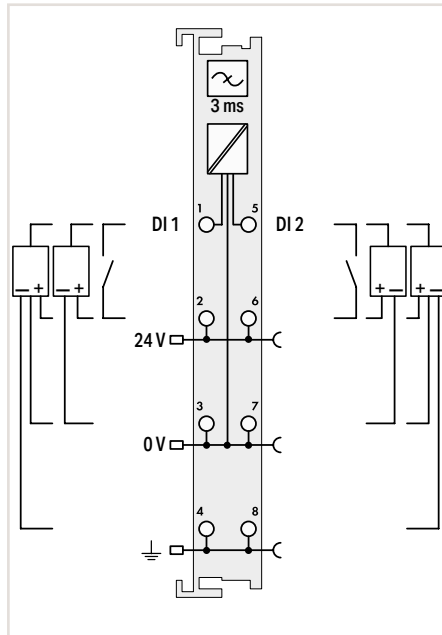
„ Approvals and corresponding ratings, see page 518 or [www.wago.com](http://www.wago.com)

## Digital Input; 24 VDC; 3 ms



Figure: 750-400

Figure: 753-400



Item Description	2-Channel Digital Input; 24 VDC; 3 ms			2-Channel Digital Input; 24 VDC; 3 ms; Acknowledgement; Diagnostics	
Version	Standard	Extended temperature	Pluggable (delivery without connector)	Standard	Pluggable (delivery without connector)
Item No.	750-400	750-400/025-000	753-400	750-418	753-418
Order Text	2DI; 24 VDC; 3ms	2DI; 24 VDC; 3ms; T	2DI; 24 VDC; 3ms	2DI; 24 VDC; 3ms; Acknol; Diagn	2DI; 24 VDC; 3ms; Acknol; Diagn
<b>Technical Data</b>					
Pluggable connector			•		•
Number of digital inputs	2			2	
Signal type	24 VDC			24 VDC	
Voltage range for signal (0)	-3 ... +5 VDC			-3 ... +5 VDC	
Voltage range for signal (1)	15 ... 30 VDC			15 ... 30 VDC	
Sensor connection	2-wire; 3-wire; 4-wire			2-wire; 3-wire	
Input characteristic	High-side switching			High-side switching	
Input filter (digital)	3 ms			3 ms	
Input current per channel for signal (1) typ.	4.5 mA			3.7 mA	
Supply voltage (sensor)	24 VDC			24 VDC; short-circuit-protected; isolated channels	
Supply voltage (field)	24 VDC (-25 ... +30 %); via power jumper contacts (power supply via blade contact; transmission via spring contact)			24 VDC (-25 ... +30 %); via power jumper contacts (power supply via blade contact; transmission via spring contact)	
Current consumption – system supply (5 V)	3.7 mA			12 mA	
Data width (internal)	2 bits			4 bits	
Diagnostics				Short circuit; active acknowledgement after error rectified	
Isolation	500 V system/field			500 V system/field	
Surrounding air temperature (operation)	0 ... +55 °C	-20 ... +60 °C	0 ... +55 °C	0 ... +55 °C	
Dimensions W x H x D	12 x 69.8 x 100 mm			12 x 69.8 x 100 mm	
Approvals	CE; Marine; OrdLoc/HazLoc; ATEX/IECEX			CE; Marine; OrdLoc/HazLoc; ATEX/IECEX	
Data sheet and further information, see:	<a href="http://wago.com/750-400">wago.com/750-400</a>		<a href="http://wago.com/753-400">wago.com/753-400</a>	<a href="http://wago.com/750-418">wago.com/750-418</a>	<a href="http://wago.com/753-418">wago.com/753-418</a>
<b>Accessories</b>			<b>Item No.</b>		<b>Item No.</b>
Pluggable connector			753-110		753-110
Coding keys			753-150		753-150

## Digital Input; 24 VDC; 3 ms



Figure: 750-421

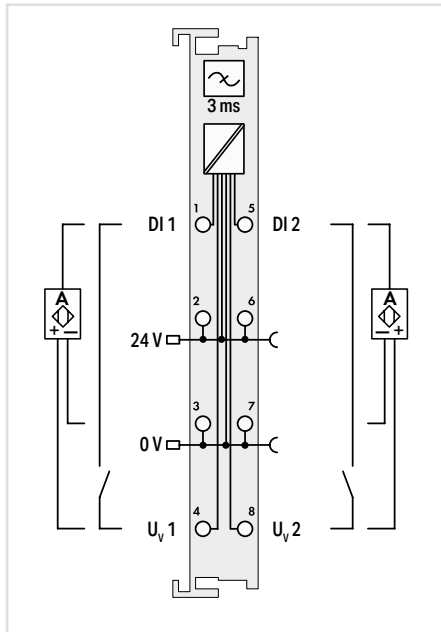
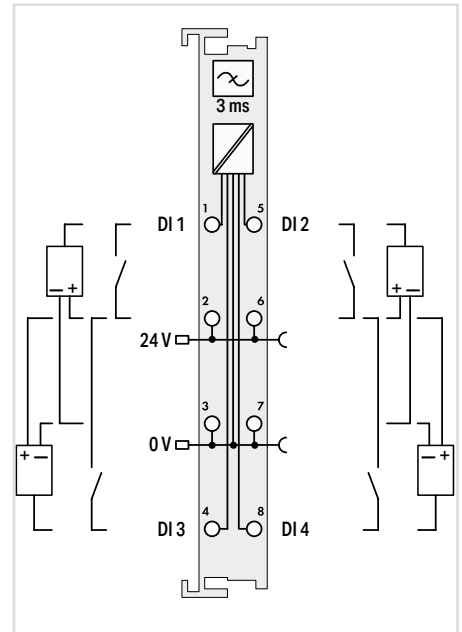


Figure: 750-402



Item Description	2-Channel Digital Input; 24 VDC; 3 ms; Diagnostics		4-Channel Digital Input; 24 VDC; 3 ms		
Version	Standard	Pluggable (delivery without connector)	Standard	Extended temperature	Pluggable (delivery without connector)
Item No.	750-421	753-421	750-402	750-402/025-000	753-402
Order Text	2DI; 24 VDC; 3ms; Diagn	2DI; 24 VDC; 3ms; Diagn	4DI; 24 VDC; 3ms	4DI; 24 VDC; 3ms; T	4DI; 24 VDC; 3ms
<b>Technical Data</b>					
Pluggable connector		●			●
Number of digital inputs	2		4		
Signal type	24 VDC		24 VDC		
Voltage range for signal (0)	-3 ... +5 VDC		-3 ... +5 VDC		
Voltage range for signal (1)	15 ... 30 VDC		15 ... 30 VDC		
Sensor connection	2-wire; 3-wire		2 x (2-wire; 3-wire)*		
Input characteristic	High-side switching		High-side switching		
Input filter (digital)	3 ms		3 ms		
Input current per channel for signal (1) typ.	3.7 mA		4.5 mA		
Supply voltage (sensor)	24 VDC; short-circuit-protected; isolated channels		24 VDC		
Supply voltage (field)	24 VDC (-25 ... +30 %); via power jumper contacts (power supply via blade contact; transmission via spring contact)		24 VDC (-25 ... +30 %); via power jumper contacts (power supply via blade contact; transmission via spring contact)		
Current consumption – system supply (5 V)	12 mA		7.5 mA		
Data width (internal)	4 bits		4 bits		
Diagnostics	Short circuit; automatic acknowledgement after error rectified				
Isolation	500 V system/field		500 V system/field		
Surrounding air temperature (operation)	0 ... +55 °C		0 ... +55 °C	-20 ... +60 °C	0 ... +55 °C
Dimensions W x H x D	12 x 69.8 x 100 mm		12 x 69.8 x 100 mm		
Approvals	CE;  Marine;  OrdLoc/HazLoc;  ATEX/IECEX		CE;  Marine;  OrdLoc/HazLoc;  ATEX/IECEX		
Data sheet and further information, see:	<a href="http://wago.com/750-421">wago.com/750-421</a>	<a href="http://wago.com/753-421">wago.com/753-421</a>	<a href="http://wago.com/750-402">wago.com/750-402</a>	<a href="http://wago.com/753-402">wago.com/753-402</a>	
<b>Accessories</b>		<b>Item No.</b>		<b>Item No.</b>	
Pluggable connector		753-110		753-110	
Coding keys		753-150		753-150	

\*A suitable field side connection module (e.g., 750-614) must also be used to connect other sensors.

„ Mini-WSB marker card and mounting accessories, see Section "Accessories and Tools"  
 „ Approvals and corresponding ratings, see page 518 or www.wago.com



## Digital Input; 24 VDC; 3 ms



Figure: 750-432

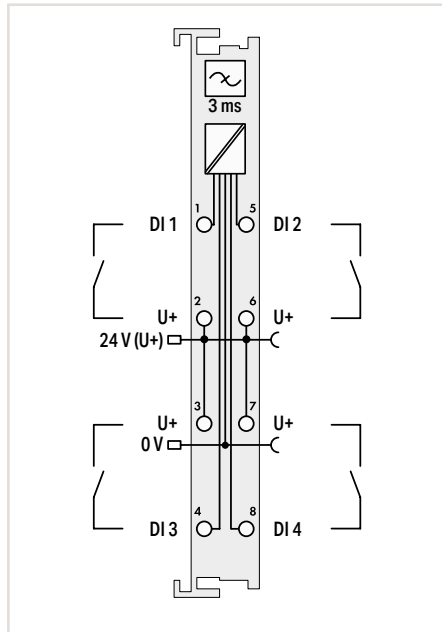
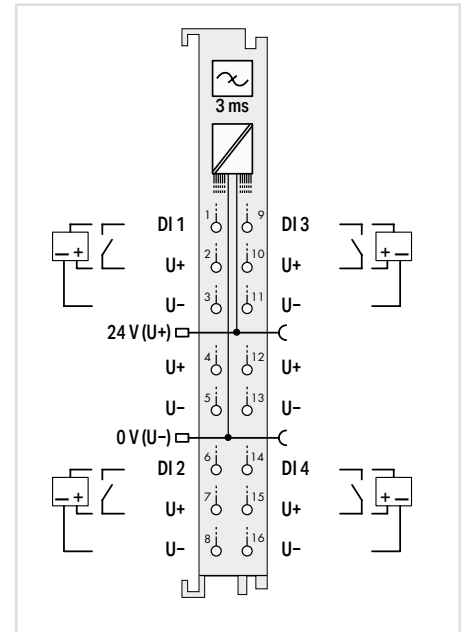


Figure: 750-1420



Item Description	4-Channel Digital Input; 24 VDC; 3 ms; 2-wire connection		4-Channel Digital Input; 24 VDC; 3 ms; 3-wire connection
Version	Standard	Pluggable (delivery without connector)	Standard with 16 connectors
Item No.	750-432	753-432	750-1420
Order Text	4DI; 24 VDC; 3ms; 2-wire	4DI; 24 VDC; 3ms; 2-wire	4DI; 24 VDC; 3ms; 3-wire
<b>Technical Data</b>			
Pluggable connector		●	
Number of digital inputs	4		4
Signal type	24 VDC		24 VDC
Voltage range for signal (0)	-3 ... +5 VDC		-3 ... +5 VDC
Voltage range for signal (1)	15 ... 30 VDC		11 ... 30 VDC
Sensor connection	2-wire		3-wire
Input characteristic	High-side switching		High-side switching
Input filter (digital)	3 ms		3 ms
Input current per channel for signal (1) typ.	4.5 mA		4.5 mA
Supply voltage (sensor)	24 VDC		24 VDC
Supply voltage (field)	24 VDC (-25 ... +30 %); via power jumper contacts (power supply via blade contact; transmission via spring contact)		24 VDC (-25 ... +30 %); via power jumper contacts (power supply via blade contact; transmission via spring contact)
Current consumption – system supply (5 V)	5.5 mA		4 mA
Data width (internal)	4 bits		4 bits
Isolation	500 V system/field		500 V system/field
Surrounding air temperature (operation)	0 ... +55 °C		0 ... +55 °C
Dimensions W x H x D	12 x 69.8 x 100 mm		12 x 69 x 100 mm
Approvals	CE;  Marine;  OrdLoc/HazLoc;  ATEX/IECEx		CE;  Marine;  OrdLoc/HazLoc;  ATEX/IECEx
Data sheet and further information, see:	<a href="http://wago.com/750-432">wago.com/750-432</a>	<a href="http://wago.com/753-432">wago.com/753-432</a>	<a href="http://wago.com/750-1420">wago.com/750-1420</a>
<b>Accessories</b>			
Pluggable connector		Item No.	753-110
Coding keys			753-150

## Digital Input; 24 VDC; 3 ms



Figure: 750-430

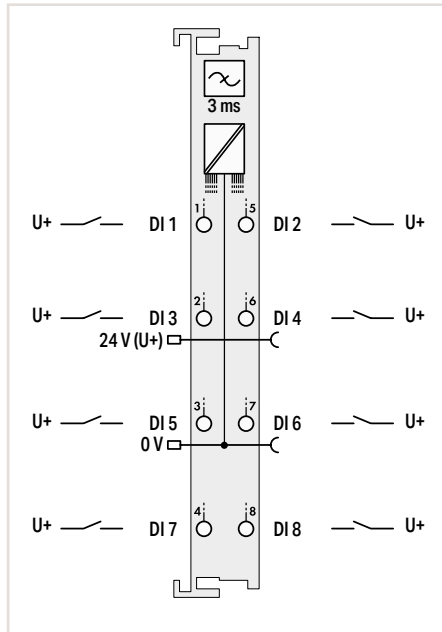
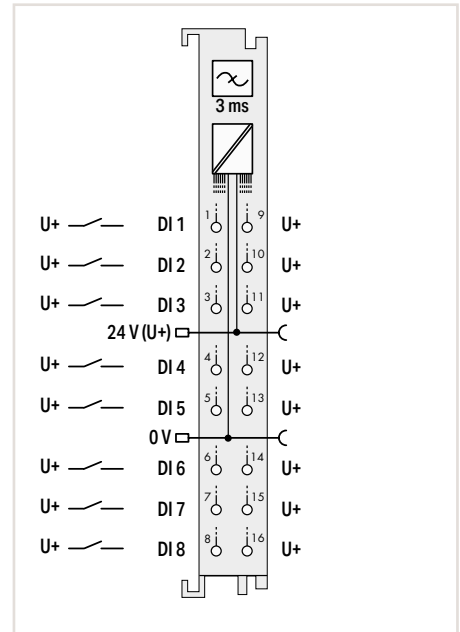


Figure: 750-1415



Item Description	8-Channel Digital Input; 24 VDC; 3 ms			8-Channel Digital Input; 24 VDC; 3 ms; 2-wire connection
Version	Standard	Extended temperature	Pluggable (delivery without connector)	Standard with 16 connectors
Item No.	750-430	750-430/025-000	753-430	750-1415
Order Text	8DI; 24 VDC; 3ms	8DI; 24 VDC; 3ms; T	8DI; 24 VDC; 3ms	8DI; 24 VDC; 3ms; 2-wire
<b>Technical Data</b>				
Pluggable connector			•	
Number of digital inputs	8			8
Signal type	24 VDC			24 VDC
Voltage range for signal (0)	-3 ... +5 VDC			-3 ... +5 VDC
Voltage range for signal (1)	15 ... 30 VDC			11 ... 30 VDC
Sensor connection	1-wire			2-wire
Input characteristic	High-side switching			High-side switching
Input filter (digital)	3 ms			3 ms
Input current per channel for signal (1) typ.	2.8 mA			4.5 mA
Supply voltage (sensor)	24 VDC			24 VDC
Supply voltage (field)	24 VDC (-25 ... +30 %); via power jumper contacts (power supply via blade contact; transmission via spring contact)			24 VDC (-25 ... +30 %); via power jumper contacts (power supply via blade contact; transmission via spring contact)
Current consumption – system supply (5 V)	17 mA			6 mA
Data width (internal)	8 bits			8 bits
Isolation	500 V system/field			500 V system/field
Surrounding air temperature (operation)	0 ... +55 °C	-20 ... +60 °C	0 ... +55 °C	0 ... +55 °C
Dimensions W x H x D	12 x 67.8 x 100 mm		12 x 69 x 100 mm	12 x 69 x 100 mm
<b>Approvals</b>	CE;  Marine;  OrdLoc/HazLoc;  ATEX/IECEx			CE;  Marine;  OrdLoc/HazLoc;  ATEX/IECEx
Data sheet and further information, see:	<a href="http://wago.com/750-430">wago.com/750-430</a>		<a href="http://wago.com/753-430">wago.com/753-430</a>	<a href="http://wago.com/750-1415">wago.com/750-1415</a>
<b>Accessories</b>				
Pluggable connector				Item No. 753-110
Coding keys				753-150

5.2

„ Mini-WSB marker card and mounting accessories, see Section "Accessories and Tools"

„ Approvals and corresponding ratings, see page 518 or [www.wago.com](http://www.wago.com)

## Digital Input; 24 VDC; 3 ms



Figure: 750-1400

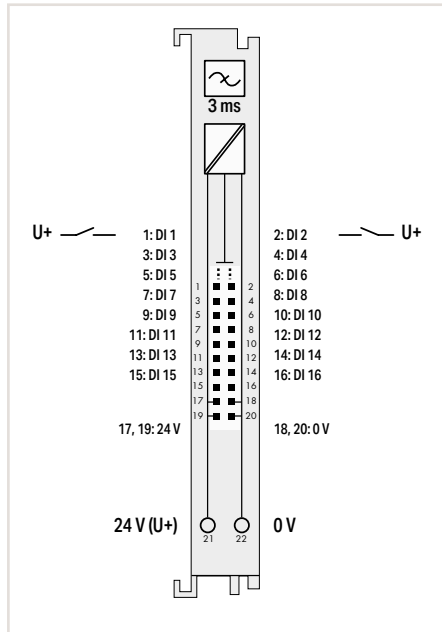
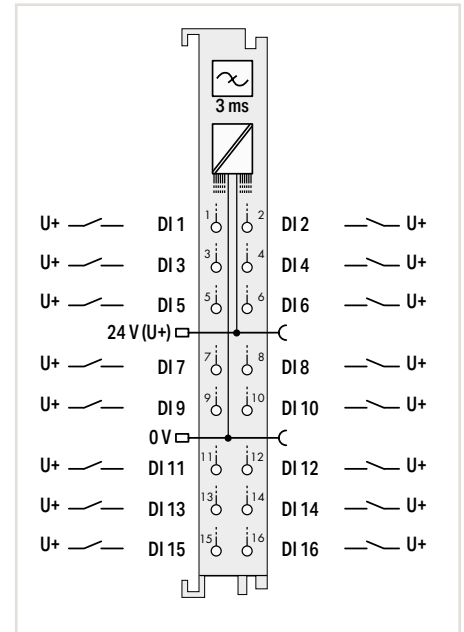


Figure: 750-1405



Item Description	16-Channel Digital Input; 24 VDC; 3 ms; Ribbon cable	16-Channel Digital Input; 24 VDC; 3 ms
Version	Standard with ribbon cable connector	Standard with 16 connectors
Item No.	750-1400	750-1405
Order Text	16DI; 24 VDC; 3ms; Ribbon Cable	16DI; 24 VDC; 3ms
<b>Technical Data</b>		
Number of digital inputs	16	16
Signal type	24 VDC	24 VDC
Voltage range for signal (0)	-3 ... +5 VDC	-3 ... +5 VDC
Voltage range for signal (1)	15 ... 30 VDC	15 ... 30 VDC
Sensor connection	1-wire	1-wire
Input characteristic	High-side switching	High-side switching
Input filter (digital)	3 ms	3 ms
Input current per channel for signal (1) typ.	2.3 mA	2.3 mA
Supply voltage (sensor)	24 VDC	
Supply voltage (field)	24 VDC (-25 ... +30 %); via wiring interface (CAGE CLAMP® connection)	24 VDC (-25 ... +30 %); via power jumper contacts (power supply via blade contact; transmission via spring contact)
Current consumption – system supply (5 V)	25 mA	25 mA
Data width (internal)	16 bits	16 bits
Isolation	500 V system/field	500 V system/field
Surrounding air temperature (operation)	0 ... +55 °C	0 ... +55 °C
Dimensions W x H x D	12 x 74.1 x 100 mm	12 x 69 x 100 mm
Approvals	CE; Marine; OrdLoc/HazLoc; ATEX/IECEx	CE; Marine; OrdLoc/HazLoc; ATEX/IECEx
Data sheet and further information, see:	<a href="http://wago.com/750-1400">wago.com/750-1400</a>	<a href="http://wago.com/750-1405">wago.com/750-1405</a>
<b>Accessories</b>		
Interface modules for system wiring and interface cable	Item No. See Section 10	

## Digital Input/Output; 24 VDC

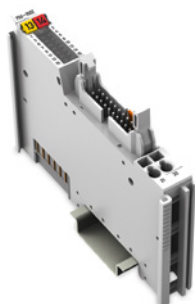
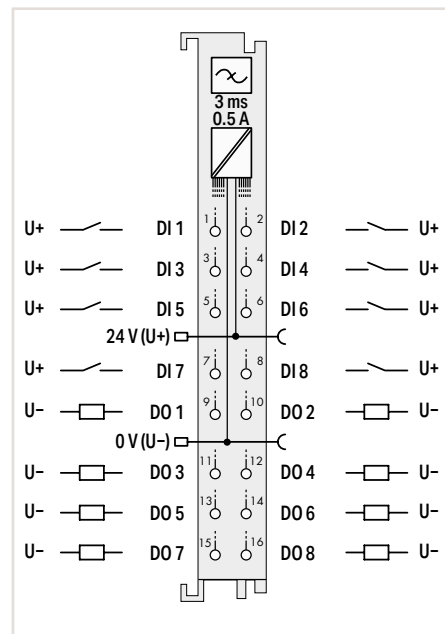
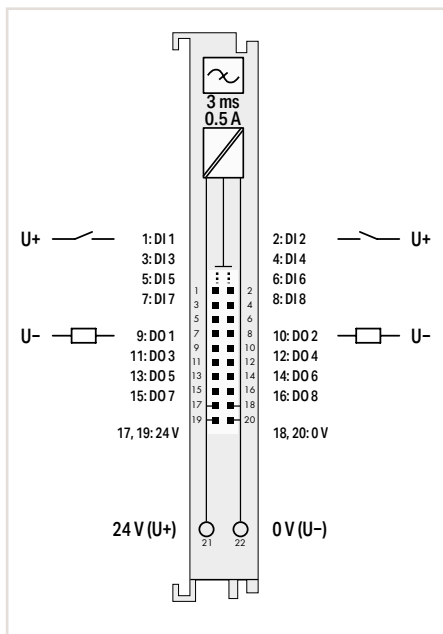


Figure: 750-1502



Figure: 750-1506



Item Description	8-Channel Digital Input/Output; 24 VDC; 0.5 A; Ribbon cable	8-Channel Digital Input/Output; 24 VDC; 0.5 A
Version	Standard with ribbon cable connector	Standard with 16 connectors
Item No.	750-1502	750-1506
Order Text	8DIO; 24 VDC; 0.5A; Ribbon Cable	8DIO; 24 VDC; 0.5A
<b>Technical Data</b>		
Number of digital inputs	8	8
Signal type	24 VDC	24 VDC
Voltage range for signal (0)	-3 ... +5 VDC	-3 ... +5 VDC
Voltage range for signal (1)	15 ... 30 VDC	15 ... 30 VDC
Sensor connection	1-wire	1-wire
Input characteristic	High-side switching	High-side switching
Input filter (digital)	3 ms	3 ms
Input current per channel for signal (1) typ.	2.4 mA	2.4 mA
Number of digital outputs	8	8
Output characteristic	High-side switching	High-side switching
Output current per channel	0.5 A; short-circuit-protected	0.5 A; short-circuit-protected
Load type	Resistive; inductive; lamp load	Resistive; inductive; lamp load
Actuator connection	1-wire	1-wire
Switching frequency (max.)	1 kHz	1 kHz
Current consumption, field supply (module with no external load)	16 mA	16 mA
Supply voltage (field)	24 VDC (-25 ... +30 %); via wiring interface (CAGE CLAMP® connection)	24 VDC (-25 ... +30 %); via power jumper contacts (power supply via blade contact; transmission via spring contact)
Current consumption – system supply (5 V)	30 mA	30 mA
Data width (internal)	8-bit input and 8-bit output	8-bit input and 8-bit output
Isolation	500 V system/field	500 V system/field
Surrounding air temperature (operation)	0 ... +55 °C	0 ... +55 °C
Dimensions W x H x D	12 x 74.1 x 100 mm	12 x 69 x 100 mm
Approvals	CE; Marine; OrdLoc/HazLoc; ATEX/IECEX	CE; Marine; OrdLoc/HazLoc; ATEX/IECEX
Data sheet and further information, see:	<a href="http://wago.com/750-1502">wago.com/750-1502</a>	<a href="http://wago.com/750-1506">wago.com/750-1506</a>
<b>Accessories</b>		
Interface modules for system wiring and interface cable	Item No. See Section 10	

„ Mini-WSB marker card and mounting accessories, see Section "Accessories and Tools"

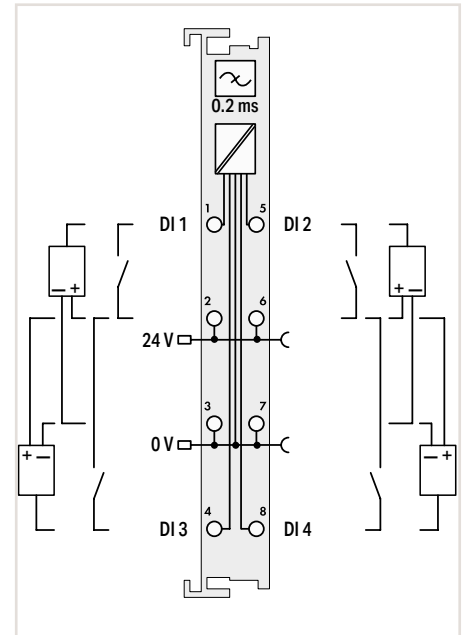
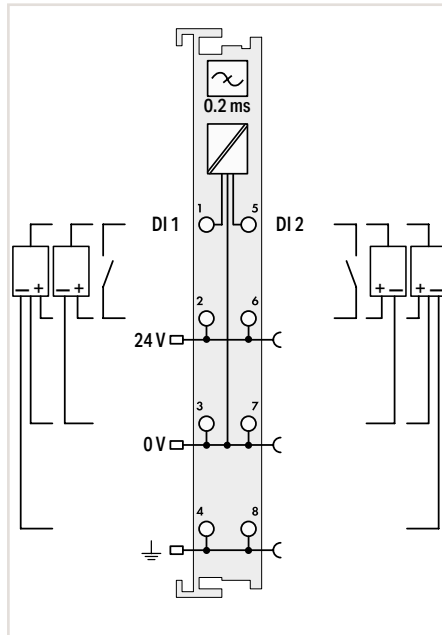
„ Approvals and corresponding ratings, see page 518 or [www.wago.com](http://www.wago.com)

## Digital Input; 24 VDC; 0.2 ms



Figure: 750-401

Figure: 753-401



Item Description		2-Channel Digital Input; 24 VDC; 0.2 ms		4-Channel Digital Input; 24 VDC; 0.2 ms	
Version		Standard	Pluggable (delivery without connector)	Standard	Pluggable (delivery without connector)
Item No.		750-401	753-401	750-403	753-403
Order Text		2DI; 24 VDC; 0.2ms	2DI; 24 VDC; 0.2ms	4DI; 24 VDC; 0.2ms	4DI; 24 VDC; 0.2ms
<b>Technical Data</b>					
Pluggable connector			•		•
Number of digital inputs		2		4	
Signal type		24 VDC		24 VDC	
Voltage range for signal (0)		-3 ... +5 VDC		-3 ... +5 VDC	
Voltage range for signal (1)		15 ... 30 VDC		15 ... 30 VDC	
Sensor connection		2-wire; 3-wire; 4-wire		2 x (2-wire; 3-wire)*	
Input characteristic		High-side switching		High-side switching	
Input filter (digital)		0.2 ms		0.2 ms	
Input current per channel for signal (1) typ.		4.5 mA		4.5 mA	
Supply voltage (sensor)		24 VDC		24 VDC	
Supply voltage (field)		24 VDC (-25 ... +30 %); via power jumper contacts (power supply via blade contact; transmission via spring contact)		24 VDC (-25 ... +30 %); via power jumper contacts (power supply via blade contact; transmission via spring contact)	
Current consumption – system supply (5 V)		3.7 mA		7.5 mA	
Data width (internal)		2 bits		4 bits	
Isolation		500 V system/field		500 V system/field	
Surrounding air temperature (operation)		0 ... +55 °C		0 ... +55 °C	
Dimensions W x H x D		12 x 69.8 x 100 mm		12 x 69.8 x 100 mm	
<b>Approvals</b>					
		CE;  Marine;  OrdLoc/HazLoc;  ATEX/IECEX		CE;  Marine;  OrdLoc/HazLoc;  ATEX/IECEX	
Data sheet and further information, see:		<a href="http://wago.com/750-401">wago.com/750-401</a>	<a href="http://wago.com/753-401">wago.com/753-401</a>	<a href="http://wago.com/750-403">wago.com/750-403</a>	<a href="http://wago.com/753-403">wago.com/753-403</a>
<b>Accessories</b>			<b>Item No.</b>		<b>Item No.</b>
Pluggable connector			753-110		753-110
Coding keys			753-150		753-150

\*A suitable field side connection module (e.g., 750-614) must also be used to connect other sensors.

## Digital Input; 24 VDC; 0.2 ms



Figure: 750-433

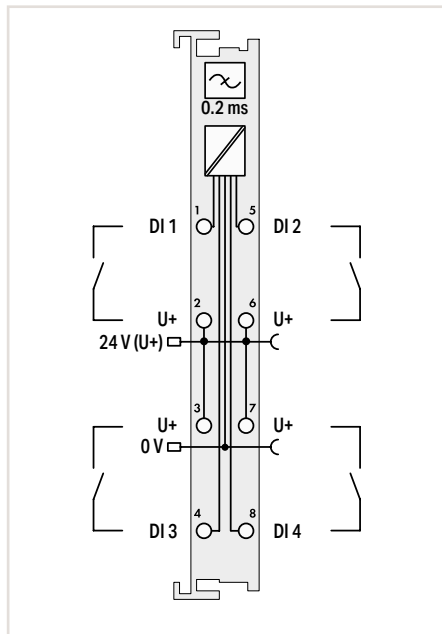
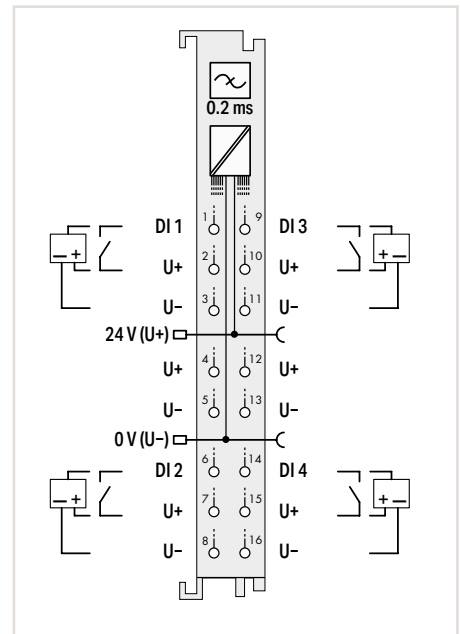
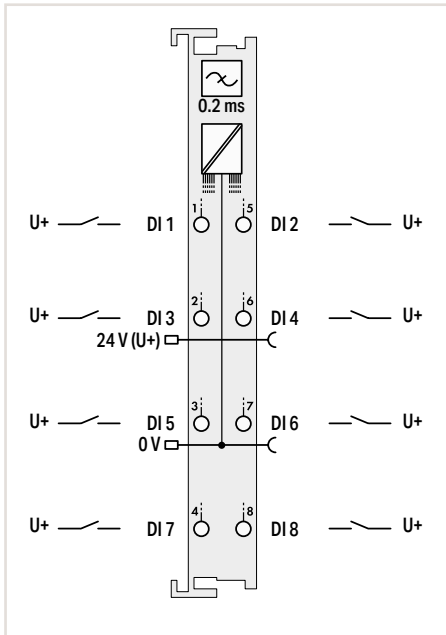


Figure: 750-1421

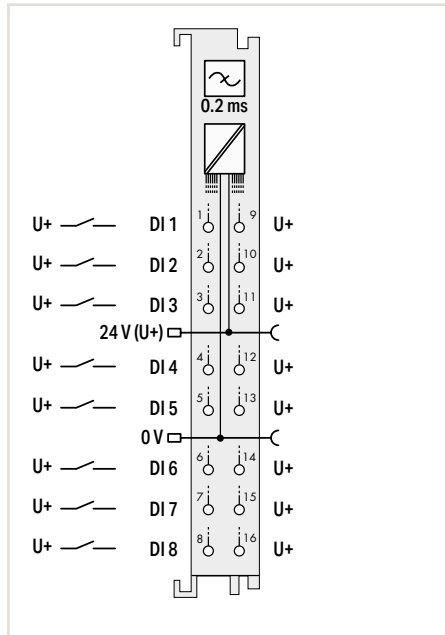


Item Description	4-Channel Digital Input; 24 VDC; 0.2 ms; 2-wire connection		4-Channel Digital Input; 24 VDC; 0.2 ms; 3-wire connection
Version	Standard	Pluggable (delivery without connector)	Standard with 16 connectors
Item No.	750-433	753-433	750-1421
Order Text	4DI; 24 VDC; 0.2ms	4DI; 24 VDC; 0.2ms	4DI; 24 VDC; 0.2ms; 3-wire
<b>Technical Data</b>			
Pluggable connector		●	
Number of digital inputs	4		4
Signal type	24 VDC		24 VDC
Voltage range for signal (0)	-3 ... +5 VDC		-3 ... +5 VDC
Voltage range for signal (1)	15 ... 30 VDC		11 ... 30 VDC
Sensor connection	2-wire		3-wire
Input characteristic	High-side switching		High-side switching
Input filter (digital)	0.2 ms		0.2 ms
Input current per channel for signal (1) typ.	4.5 mA		4.5 mA
Supply voltage (sensor)	24 VDC		24 VDC
Supply voltage (field)	24 VDC (-25 ... +30 %); via power jumper contacts (power supply via blade contact; transmission via spring contact)		24 VDC (-25 ... +30 %); via power jumper contacts (power supply via blade contact; transmission via spring contact)
Current consumption – system supply (5 V)	5.5 mA		4 mA
Data width (internal)	4 bits		4 bits
Isolation	500 V system/field		500 V system/field
Surrounding air temperature (operation)	0 ... +55 °C		0 ... +55 °C
Dimensions W x H x D	12 x 69.8 x 100 mm		12 x 69 x 100 mm
Approvals	CE; Marine; OrdLoc/HazLoc; ATEX/IECEX		CE; Marine; OrdLoc/HazLoc; ATEX/IECEX
Data sheet and further information, see:	<a href="http://wago.com/750-433">wago.com/750-433</a>	<a href="http://wago.com/753-433">wago.com/753-433</a>	<a href="http://wago.com/750-1421">wago.com/750-1421</a>
<b>Accessories</b>			
Pluggable connector		Item No.	753-110
Coding keys		Item No.	753-150

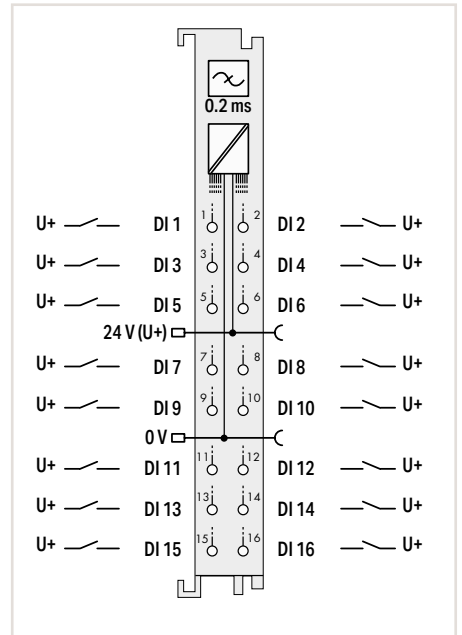
„ Mini-WSB marker card and mounting accessories, see Section "Accessories and Tools"  
 „ Approvals and corresponding ratings, see page 518 or www.wago.com



8-Channel Digital Input; 24 VDC; 0.2 ms	
Standard	Pluggable (delivery without connector)
750-431	753-431
8DI; 24 VDC; 0.2ms	8DI; 24 VDC; 0.2ms



8-Channel Digital Input; 24 VDC; 0.2 ms; 2-wire connection	
Standard with 16 connectors	
750-1416	
8DI; 24 VDC; 0.2ms; 2-wire	



16-Channel Digital Input; 24 VDC; 0.2 ms	
Standard with 16 connectors	
750-1406	
16DI; 24 VDC; 0.2ms	

8	
24 VDC	
-3 ... +5 VDC	
15 ... 30 VDC	
1-wire	
High-side switching	
0.2 ms	
2.8 mA	
24 VDC (-25 ... +30 %); via power jumper contacts (power supply via blade contact; transmission via spring contact)	
17 mA	
8 bits	
500 V system/field	
0 ... +55 °C	
12 x 67.8 x 100 mm	12 x 69 x 100 mm
CE; Marine; OrdLoc/HazLoc; ATEX/IECEx	
wago.com/750-431	wago.com/753-431

8	
24 VDC	
-3 ... +5 VDC	
11 ... 30 VDC	
2-wire	
High-side switching	
0.2 ms	
4.5 mA	
24 VDC	
24 VDC (-25 ... +30 %); via power jumper contacts (power supply via blade contact; transmission via spring contact)	
6 mA	
8 bits	
500 V system/field	
0 ... +55 °C	
12 x 69 x 100 mm	
CE; Marine; OrdLoc/HazLoc; ATEX/IECEx	
wago.com/750-1416	

16	
24 VDC	
-3 ... +5 VDC	
15 ... 30 VDC	
1-wire	
High-side switching	
0.2 ms	
2.3 mA	
24 VDC (-25 ... +30 %); via power jumper contacts (power supply via blade contact; transmission via spring contact)	
25 mA	
16 bits	
500 V system/field	
0 ... +55 °C	
12 x 69 x 100 mm	
CE; Marine; OrdLoc/HazLoc; ATEX/IECEx	
wago.com/750-1406	

Item No.
753-110
753-150

Item No.

Item No.

## Digital Input; 24 VDC; 3 ms; Low-Side Switching



Figure: 750-408

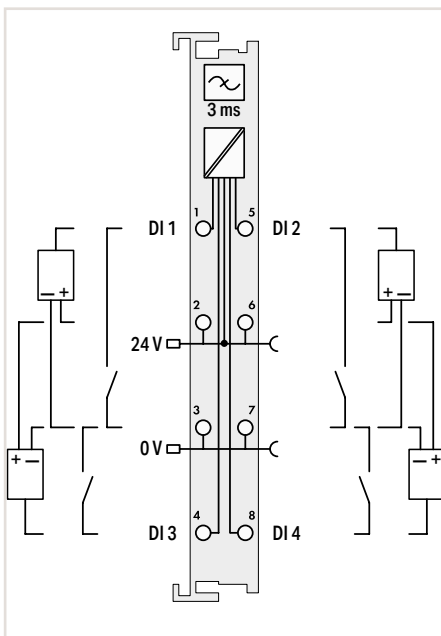
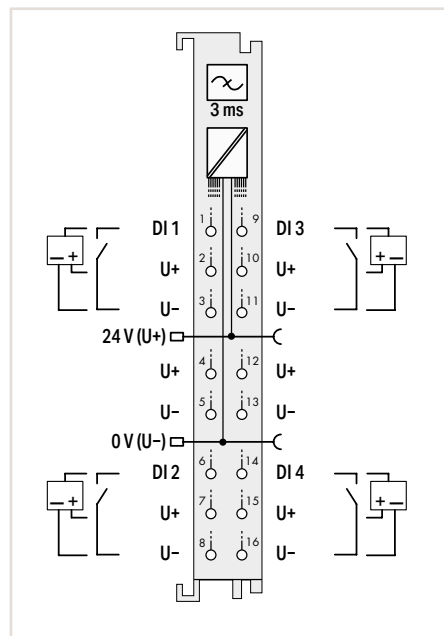


Figure: 750-1422



Item Description	4-Channel Digital Input; 24 VDC; 3 ms; Low-side switching			4-Channel Digital Input; 24 VDC; 3 ms; Low-side switching; 3-wire connection
Version	Standard	Extended temperature	Pluggable (delivery without connector)	Standard with 16 connectors
Item No.	750-408	750-408/025-000	753-408	750-1422
Order Text	4DI; 24 VDC; 3ms; LSS	4DI; 24 VDC; 3ms; LSS; T	4DI; 24 VDC; 3ms; LSS	4DI; 24 VDC; 3ms; LSS; 3-wire

Technical Data	4-Channel Digital Input; 24 VDC; 3 ms; Low-side switching			4-Channel Digital Input; 24 VDC; 3 ms; Low-side switching; 3-wire connection
Pluggable connector			•	
Number of digital inputs	4			4
Signal type	24 VDC			24 VDC
Voltage range for signal (0)	$(U_V - 5 V) \dots U_V$ DC			$(U_V - 5 V) \dots U_V$ DC
Voltage range for signal (1)	-3 VDC ... $(U_V - 15 V)$			-3 VDC ... $(U_V - 15 V)$
Sensor connection	2 x (2-wire; 3-wire)*			3-wire
Input characteristic	Low-side switching			Low-side switching
Input filter (digital)	3 ms			3 ms
Input current per channel for signal (0) typ.	7 mA			2.5 mA
Supply voltage (sensor)	24 VDC			24 VDC
Supply voltage (field)	24 VDC (-15 ... +20 %); via power jumper contacts (power supply via blade contact; transmission via spring contact)			24 VDC (-25 ... +30 %); via power jumper contacts (power supply via blade contact; transmission via spring contact)
Current consumption – system supply (5 V)	5 mA			7 mA
Data width (internal)	4 bits			4 bits
Isolation	500 V system/field			500 V system/field
Surrounding air temperature (operation)	0 ... +55 °C	-20 ... +60 °C	0 ... +55 °C	0 ... +55 °C
Dimensions W x H x D	12 x 69.8 x 100 mm			12 x 69 x 100 mm
Approvals	CE;  Marine;  OrdLoc/HazLoc;  ATEX/IECEx			CE;  Marine;  OrdLoc/HazLoc;  ATEX/IECEx
Data sheet and further information, see:	<a href="http://wago.com/750-408">wago.com/750-408</a>		<a href="http://wago.com/753-408">wago.com/753-408</a>	<a href="http://wago.com/750-1422">wago.com/750-1422</a>

Accessories	Item No.
Pluggable connector	753-110
Coding keys	753-150

\*A suitable field side connection module (e.g., 750-614) must also be used to connect other sensors.

- „ Mini-WSB marker card and mounting accessories, see Section "Accessories and Tools"
- „ Approvals and corresponding ratings, see page 518 or [www.wago.com](http://www.wago.com)



## Digital Input; 24 VDC; 3 ms; Low-Side Switching



Figure: 750-436

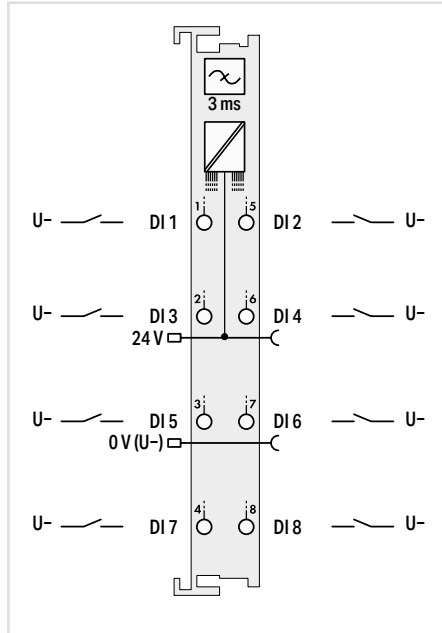
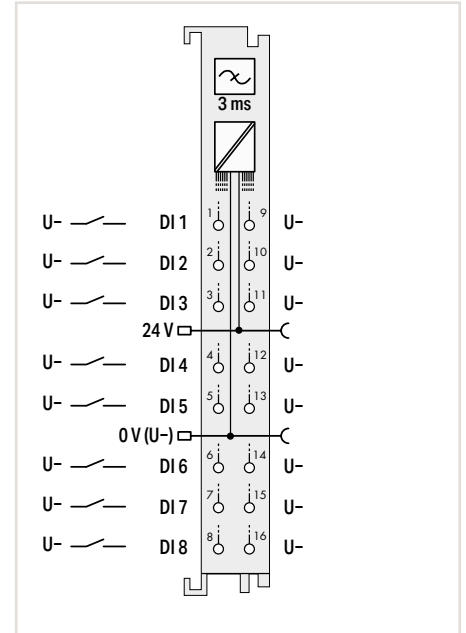


Figure: 750-1417



Item Description		8-Channel Digital Input; 24 VDC; 3 ms; Low-side switching		8-Channel Digital Input; 24 VDC; 3 ms; Low-side switching; 2-wire connection	
Version		Standard	Pluggable (delivery without connector)	Standard with 16 connectors	
Item No.		750-436	753-436	750-1417	
Order Text		8DI; 24 VDC; 3ms; LSS	8DI; 24 VDC; 3ms; LSS	8DI; 24 VDC; 3ms; LSS; 2-wire	
<b>Technical Data</b>					
Pluggable connector			•		
Number of digital inputs		8		8	
Signal type		24 VDC		24 VDC	
Voltage range for signal (0)		15 ... 30 VDC		(U <sub>v</sub> - 5 V) ... U <sub>v</sub> DC	
Voltage range for signal (1)		-3 ... +5 VDC		-3 VDC ... (U <sub>v</sub> - 15 V)	
Sensor connection		1-wire		2-wire	
Input characteristic		Low-side switching		Low-side switching	
Input filter (digital)		3 ms		3 ms	
Input current per channel for signal (0) typ.		2.8 mA		2.4 mA	
Supply voltage (sensor)				24 VDC	
Supply voltage (field)		24 VDC (-25 ... +30 %); via power jumper contacts (power supply via blade contact; transmission via spring contact)		24 VDC (-25 ... +30 %); via power jumper contacts (power supply via blade contact; transmission via spring contact)	
Current consumption – system supply (5 V)		13 mA		12 mA	
Data width (internal)		8 bits		8 bits	
Isolation		500 V system/field		500 V system/field	
Surrounding air temperature (operation)		0 ... +55 °C		0 ... +55 °C	
Dimensions W x H x D		12 x 67.8 x 100 mm	12 x 69 x 100 mm	12 x 69 x 100 mm	
Approvals		CE;  Marine;  OrdLoc/HazLoc;  ATEX/IECEx		CE;  Marine;  OrdLoc/HazLoc;  ATEX/IECEx	
Data sheet and further information, see:		<a href="http://wago.com/750-436">wago.com/750-436</a>	<a href="http://wago.com/753-436">wago.com/753-436</a>	<a href="http://wago.com/750-1417">wago.com/750-1417</a>	
<b>Accessories</b>			Item No.		
Pluggable connector			753-110		
Coding keys			753-150		

## Digital Input; 24 VDC; 3 ms; Low-Side Switching



Figure: 750-1402

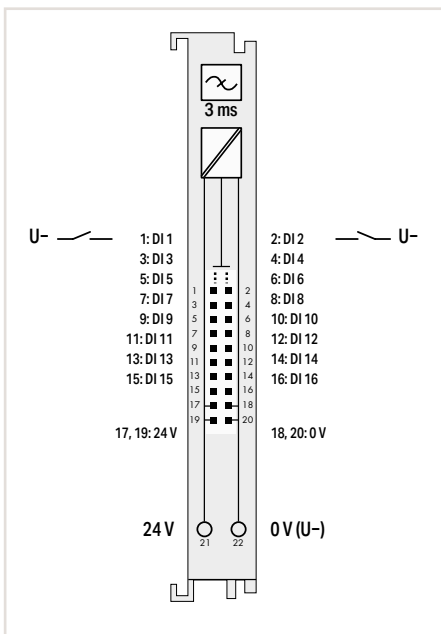
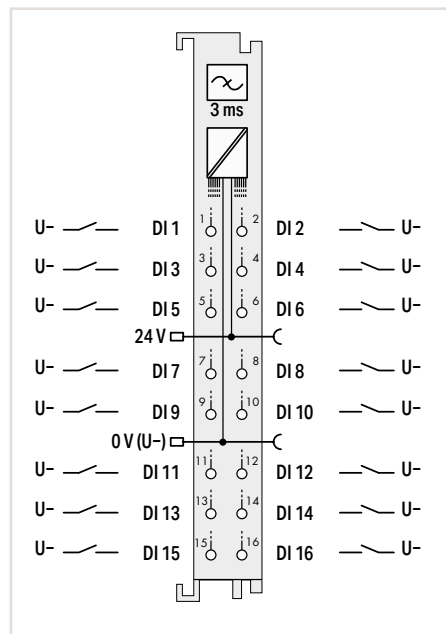


Figure: 750-1407



Item Description	16-Channel Digital Input; 24 VDC; 3 ms; Low-side switching; Ribbon cable	16-Channel Digital Input; 24 VDC; 3 ms; Low-side switching
Version	Standard with ribbon cable connector	Standard with 16 connectors
Item No.	750-1402	750-1407
Order Text	16DI; 24 VDC; 3ms; LSS; Ribbon Cable	16DI; 24 VDC; 3ms; LSS
<b>Technical Data</b>		
Number of digital inputs	16	16
Signal type	24 VDC	24 VDC
Voltage range for signal (0)	(U <sub>V</sub> - 5 V) ... U <sub>V</sub> DC	(U <sub>V</sub> - 5 V) ... U <sub>V</sub> DC
Voltage range for signal (1)	-3 VDC ... (U <sub>V</sub> - 15 V)	-3 VDC ... (U <sub>V</sub> - 15 V)
Sensor connection	1-wire	1-wire
Input characteristic	Low-side switching	Low-side switching
Input filter (digital)	3 ms	3 ms
Input current per channel for signal (1) typ.	2.3 mA	2.3 mA
Supply voltage (sensor)	24 VDC	
Supply voltage (field)	24 VDC (-25 ... +30 %); via wiring interface (CAGE CLAMP® connection)	24 VDC (-25 ... +30 %); via power jumper contacts (power supply via blade contact; transmission via spring contact)
Current consumption – system supply (5 V)	25 mA	25 mA
Data width (internal)	16 bits	16 bits
Isolation	500 V system/field	500 V system/field
Surrounding air temperature (operation)	0 ... +55 °C	0 ... +55 °C
Dimensions W x H x D	12 x 74.1 x 100 mm	12 x 69 x 100 mm
Approvals	CE; Marine; OrdLoc/HazLoc; ATEX/IECEX	CE; Marine; OrdLoc/HazLoc; ATEX/IECEX
Data sheet and further information, see:	<a href="http://wago.com/750-1402">wago.com/750-1402</a>	<a href="http://wago.com/750-1407">wago.com/750-1407</a>
<b>Accessories</b>		
Interface modules for system wiring and inter-face cable	Item No. See Section 10	

„ Mini-WSB marker card and mounting accessories, see Section "Accessories and Tools"

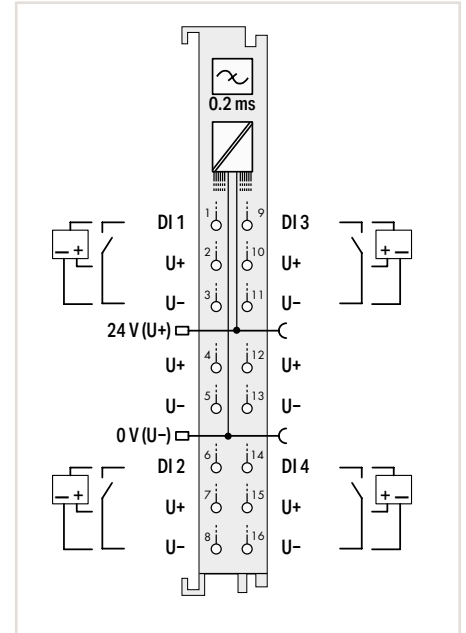
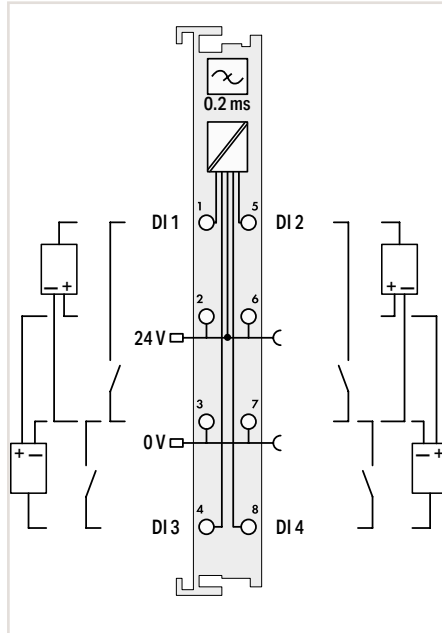
„ Approvals and corresponding ratings, see page 518 or [www.wago.com](http://www.wago.com)

## Digital Input; 24 VDC; 0.2 ms; Low-Side Switching



Figure: 750-409

Figure: 750-1423



Item Description	4-Channel Digital Input; 24 VDC; 0.2 ms; Low-side switching		4-Channel Digital Input; 24 VDC; 0.2 ms; Low-side switching; 3-wire connection
Version	Standard	Pluggable (delivery without connector)	Standard with 16 connectors
Item No.	750-409	753-409	750-1423
Order Text	4DI; 24 VDC; 0.2ms; LSS	4DI; 24 VDC; 0.2ms; LSS	4DI; 24 VDC; 0.2ms; LSS; 3-wire
<b>Technical Data</b>			
Pluggable connector		●	
Number of digital inputs	4		4
Signal type	24 VDC		24 VDC
Voltage range for signal (0)	$(U_V - 5 V) \dots U_V$ DC		$(U_V - 5 V) \dots U_V$ DC
Voltage range for signal (1)	-3 VDC ... $(U_V - 15 V)$		-3 VDC ... $(U_V - 15 V)$
Sensor connection	2 x (2-wire; 3-wire)*		3-wire
Input characteristic	Low-side switching		Low-side switching
Input filter (digital)	0.2 ms		0.2 ms
Input current per channel for signal (0) typ.	7 mA		2.5 mA
Supply voltage (sensor)	24 VDC		24 VDC
Supply voltage (field)	24 VDC (-25 ... +30 %); via power jumper contacts (power supply via blade contact; transmission via spring contact)		24 VDC (-25 ... +30 %); via power jumper contacts (power supply via blade contact; transmission via spring contact)
Current consumption – system supply (5 V)	5 mA		7 mA
Data width (internal)	4 bits		4 bits
Isolation	500 V system/field		500 V system/field
Surrounding air temperature (operation)	0 ... +55 °C		0 ... +55 °C
Dimensions W x H x D	12 x 69.8 x 100 mm		12 x 69 x 100 mm
Approvals	CE;   OrdLoc/HazLoc;  ATEX/IECEx		CE;   Marine;  OrdLoc/HazLoc;  ATEX/IECEx
Data sheet and further information, see:	<a href="http://wago.com/750-409">wago.com/750-409</a>	<a href="http://wago.com/753-409">wago.com/753-409</a>	<a href="http://wago.com/750-1423">wago.com/750-1423</a>
<b>Accessories</b>			
Pluggable connector		Item No.	753-110
Coding keys			753-150

\*A suitable field side connection module (e.g., 750-614) must also be used to connect other sensors.

## Digital Input; 24 VDC; 0.2 ms; Low-Side Switching



Figure: 750-437

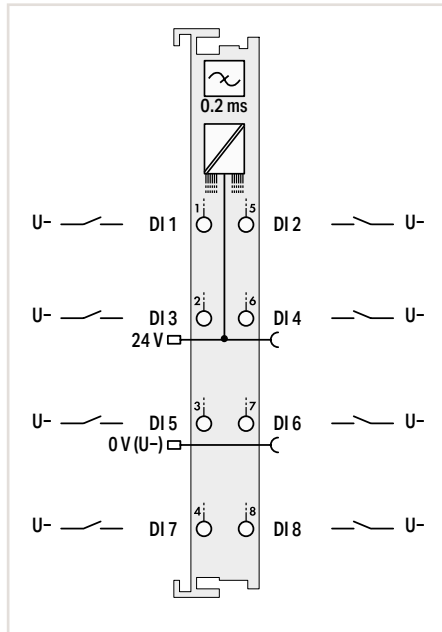
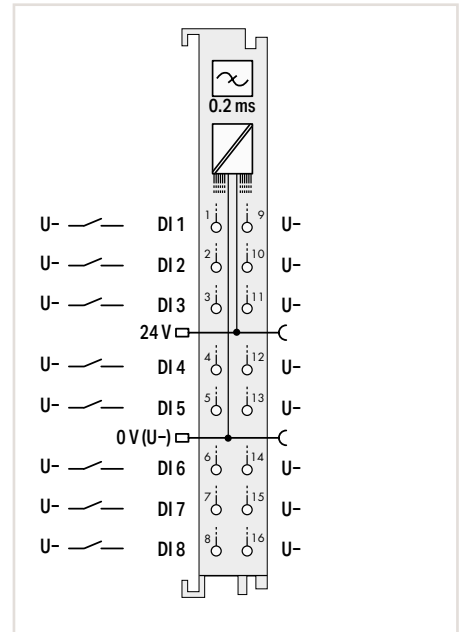


Figure: 750-1418



Item Description	8-Channel Digital Input; 24 VDC; 0.2 ms; Low-side switching		8-Channel Digital Input; 24 VDC; 0.2 ms; Low-side switching; 2-wire connection
Version	Standard		Standard with 16 connectors
Item No.	750-437	Pluggable (delivery without connector) 753-437	750-1418
Order Text	8DI; 24 VDC; 0.2ms; LSS	8DI; 24 VDC; 0.2ms; LSS	8DI; 24 VDC; 0.2ms; LSS; 2-wire
<b>Technical Data</b>			
Pluggable connector			
Number of digital inputs	8		8
Signal type	24 VDC		24 VDC
Voltage range for signal (0)	15 ... 30 VDC		(U <sub>v</sub> - 5 V) ... U <sub>v</sub> DC
Voltage range for signal (1)	-3 ... +5 VDC		-3 VDC ... (U <sub>v</sub> - 15 V)
Sensor connection	1-wire		2-wire
Input characteristic	Low-side switching		Low-side switching
Input filter (digital)	0.2 ms		0.2 ms
Input current per channel for signal (0) typ.	2.8 mA		2.4 mA
Supply voltage (sensor)	24 VDC		24 VDC
Supply voltage (field)	24 VDC (-25 ... +30 %); via power jumper contacts (power supply via blade contact; transmission via spring contact)		24 VDC (-25 ... +30 %); via power jumper contacts (power supply via blade contact; transmission via spring contact)
Current consumption – system supply (5 V)	13 mA		12 mA
Data width (internal)	8 bits		8 bits
Isolation	500 V system/field		500 V system/field
Surrounding air temperature (operation)	0 ... +55 °C		0 ... +55 °C
Dimensions W x H x D	12 x 67.8 x 100 mm	12 x 69 x 100 mm	12 x 69 x 100 mm
Approvals	CE;  Marine;  OrdLoc/HazLoc;  ATEX/IECEX		CE;  Marine;  OrdLoc/HazLoc;  ATEX/IECEX
Data sheet and further information, see:	<a href="http://wago.com/750-437">wago.com/750-437</a>	<a href="http://wago.com/753-437">wago.com/753-437</a>	<a href="http://wago.com/750-1418">wago.com/750-1418</a>
<b>Accessories</b>			
Pluggable connector		Item No. 753-110	
Coding keys		753-150	

5.2

„ Mini-WSB marker card and mounting accessories, see Section "Accessories and Tools"

„ Approvals and corresponding ratings, see page 518 or [www.wago.com](http://www.wago.com)

## Digital Input; 24 VDC; Proximity Sensor



Figure: 750-410

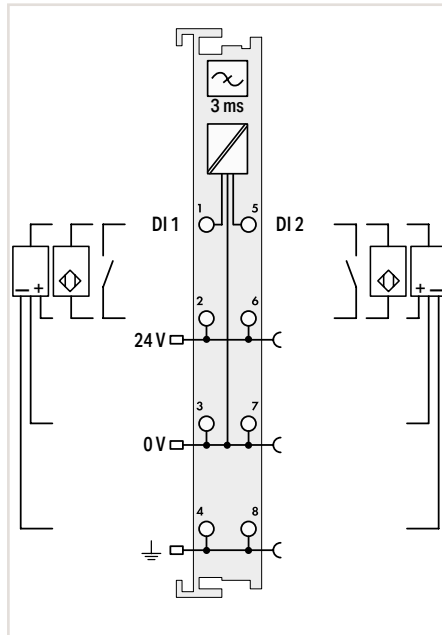
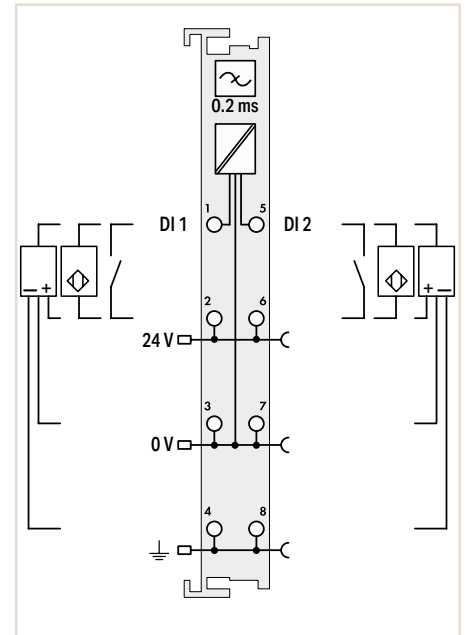


Figure: 753-410



Item Description	2-Channel Digital Input; 24 VDC; 3 ms; Proximity sensor		2-Channel Digital Input; 24 VDC; 0.2 ms; Proximity sensor	
Version	Standard	Pluggable (delivery without connector)	Standard	Pluggable (delivery without connector)
Item No.	750-410	753-410	750-411	753-411
Order Text	2DI; 24 VDC; 3ms; Proxi Sensor	2DI; 24 VDC; 3ms; Proxi Sensor	2DI; 24 VDC; 0.2ms; Proxi Sensor	2DI; 24 VDC; 0.2ms; Proxi Sensor

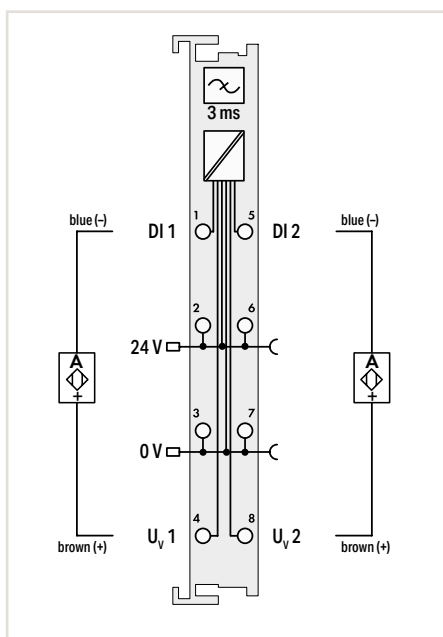
Technical Data	
Pluggable connector	•
Number of digital inputs	2
Signal type	24 VDC
Voltage range for signal (0)	-3 ... +5 VDC
Voltage range for signal (1)	15 ... 30 VDC
Sensor connection	2-wire; 3-wire; 4-wire
Input characteristic	High-side switching
Input filter (digital)	3 ms
Input current per channel for signal (1) typ.	8 mA
Supply voltage (sensor)	24 VDC
Supply voltage (field)	24 VDC (-25 ... +30 %); via power jumper contacts (power supply via blade contact; transmission via spring contact)
Current consumption – system supply (5 V)	2.5 mA
Data width (internal)	2 bits
Isolation	500 V system/field
Surrounding air temperature (operation)	0 ... +55 °C
Dimensions W x H x D	12 x 69.8 x 100 mm
Approvals	CE;  Marine;  OrdLoc/HazLoc;  ATEX/IECEX
Data sheet and further information, see:	<a href="http://wago.com/750-410">wago.com/750-410</a> <a href="http://wago.com/753-410">wago.com/753-410</a>
Accessories	Item No.
Pluggable connector	753-110
Coding keys	753-150

## Digital Input; NAMUR



Figure: 750-425

Figure: 753-425



Item Description	2-Channel Digital Input; NAMUR	
Version	Standard	Pluggable (delivery without connector)
Item No.	750-425	753-425
Order Text	2DI; NAMUR	2DI; NAMUR

Technical Data	
Pluggable connector	●
Number of digital inputs	2
Signal type	NAMUR
Signal current (0) NAMUR	≤ 1.2 mA
Signal current (1) NAMUR	≥ 2.1 mA
Sensor connection	2-wire
Input characteristic	High-side switching
Input filter (digital)	3 ms
Open-circuit voltage	8.2 VDC
Diagnostics	Short circuit; wire break
Supply voltage (sensor)	8.2 VDC; short-circuit-protected; isolated channels
Supply voltage (field)	24 VDC (-25 ... +30 %); via power jumper contacts (power supply via blade contact; transmission via spring contact)
Current consumption – system supply (5 V)	5 mA
Data width (internal)	4 bits
Isolation	500 V system/field
Surrounding air temperature (operation)	0 ... +55 °C
Dimensions W x H x D	12 x 69.8 x 100 mm
Approvals	CE; Marine; OrdLoc/HazLoc; ATEX/IECEX
Data sheet and further information, see:	<a href="http://wago.com/750-425">wago.com/750-425</a>   <a href="http://wago.com/753-425">wago.com/753-425</a>

This digital input module receives control signals from NAMUR proximity sensors (per DIN EN 60947-5-6) from the field side. Each channel of the sensors is supplied with a short-circuit-protected voltage of 8.2 V. A short circuit or a line break is indicated in the process image (1 bit) and via the red LED. The green LED indicates the input status:

- Signal current (0): LED off
- Signal current (1): LED on

Field and system levels are electrically isolated.

Accessories	Item No.
Pluggable connector	753-110
Coding keys	753-150

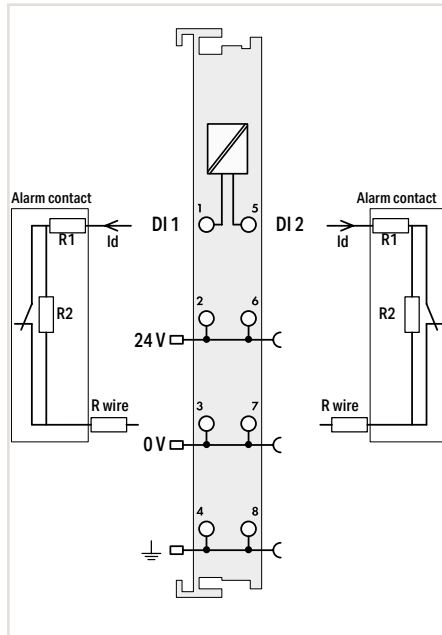
„ Mini-WSB marker card and mounting accessories, see Section "Accessories and Tools"  
 „ Approvals and corresponding ratings, see page 518 or www.wago.com

## Digital Input; Intruder Detection



Figure: 750-424

Figure: 753-424



Item Description
Version
Item No.
Order Text

**Technical Data**

Pluggable connector
Number of digital inputs
Signal type
Sensor connection
Specific sensor properties
Supply voltage (sensor)
Supply voltage (field)
Current consumption, field supply (module with no external load)
Current consumption – system supply (5 V)
Data width (internal)
Isolation
Surrounding air temperature (operation)
Dimensions W x H x D

2-Channel Digital Input; Intruder detection	
Standard	Pluggable (delivery without connector)
750-424	753-424
2DI; Intruder Detection	2DI; Intruder Detection

	●
	2
	Current loop (intruder detection)
	2-wire
	Alarm contact: R1 = 1.5 kΩ (±5 %); R2 = 2.2 kΩ (±5 %), Conductor resistance (R wire) max. 200 Ω
	24 VDC
	24 VDC (-25 ... +30 %); via power jumper contacts (power supply via blade contact; transmission via spring contact)
	16 mA
	6 mA
	4 bits
	500 V system/field
	0 ... +55 °C
	12 x 69.8 x 100 mm

**Approvals**

**Data sheet and further information, see:**

CE; Marine; OrdLoc/HazLoc;  
ATEX/IECEX

<a href="http://wago.com/750-424">wago.com/750-424</a>	<a href="http://wago.com/753-424">wago.com/753-424</a>
--	--

Accessories	Item No.
Pluggable connector	753-110
Coding keys	753-150

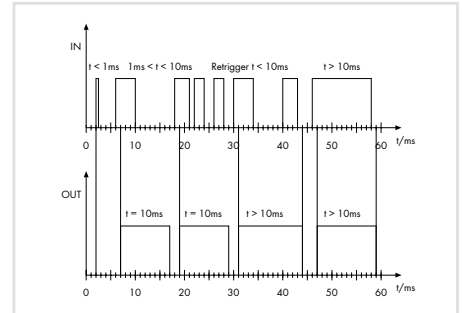
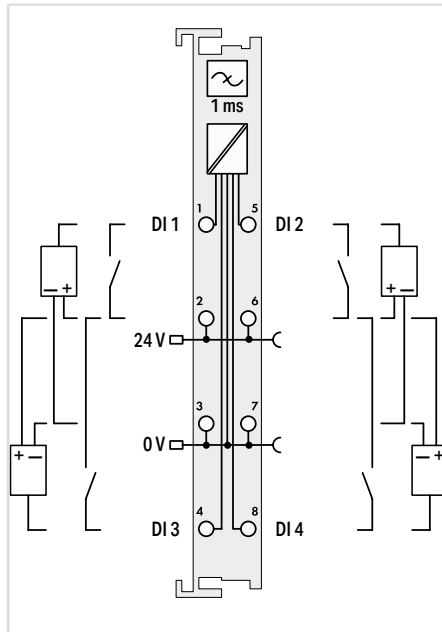
This I/O module incorporates a current loop, which makes it possible to monitor alarm contacts (window contacts) with a fixed resistance ratio (R1, R2), for intruder detection. The module indicates the status of the connected contact via LEDs and status bits in the process image.

## Digital Input; 24 VDC; Pulse Extension



Figure: 750-422

Figure: 753-422



This I/O module extends input signals to at least 10 ms. Only signals  $\geq 1$  ms will be acquired. Input signals with a pulse duration  $> 10$  ms are not extended (without fall delay). Field and system levels are electrically isolated.

Item Description	4-Channel Digital Input; 24 VDC; Pulse extension	
Version	Standard	Pluggable (delivery without connector)
Item No.	750-422	753-422
Order Text	4DI; 24 VDC; Pulse Extension	4DI; 24 VDC; Pulse Extension

Technical Data	
Pluggable connector	●
Number of digital inputs	4
Signal type	24 VDC
Voltage range for signal (0)	-3 ... +5 VDC
Voltage range for signal (1)	15 ... 30 VDC
Sensor connection	2 x (2-wire; 3-wire)*
Input characteristic	High-side switching
Input filter (digital)	1 ms
Input current per channel for signal (1) typ.	4 mA
Signal frequency (max.)	80 Hz
Supply voltage (sensor)	24 VDC
Supply voltage (field)	24 VDC (-15 ... +20 %); via power jumper contacts (power supply via blade contact; transmission via spring contact)
Current consumption – system supply (5 V)	9 mA
Data width (internal)	4 bits
Isolation	500 V system/field
Surrounding air temperature (operation)	0 ... +55 °C
Dimensions W x H x D	12 x 69.8 x 100 mm
Approvals	CE, UL, OrdLoc/HazLoc, ATEX/IECEX
Data sheet and further information, see:	wago.com/750-422   wago.com/753-422

Accessories	Item No.
Pluggable connector	753-110
Coding keys	753-150

\*A suitable field side connection module (e.g., 750-614) must also be used to connect other sensors.

„ Mini-WSB marker card and mounting accessories, see Section "Accessories and Tools"  
 „ Approvals and corresponding ratings, see page 518 or www.wago.com



## Digital Input; 24 VAC/DC



Figure: 750-415

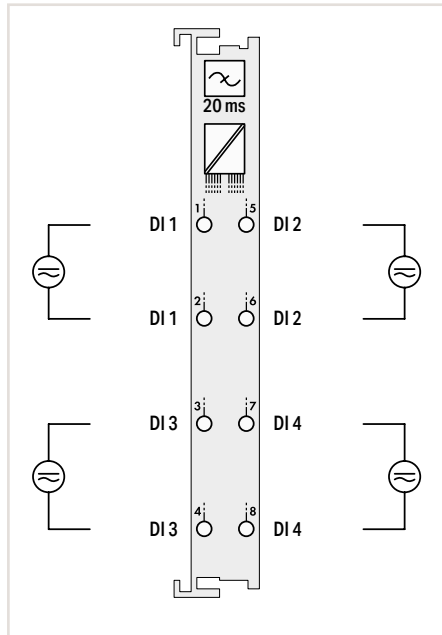
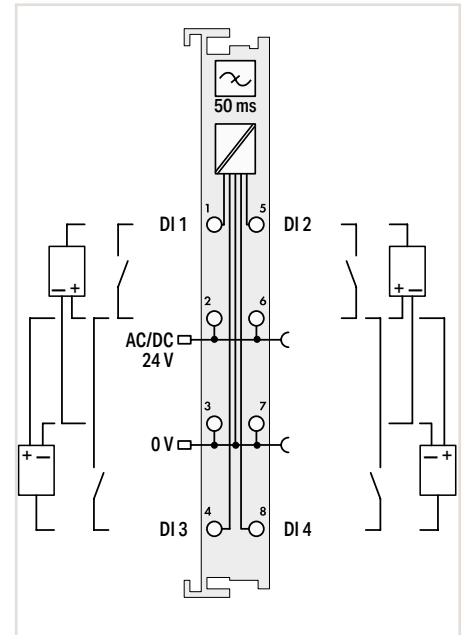


Figure: 753-415



<b>Item Description</b>	<b>4-Channel Digital Input; 24 VAC/DC; 20 ms</b>	
<b>Version</b>	<b>Standard</b>	<b>Pluggable (delivery without connector)</b>
<b>Item No.</b>	750-415	753-415
<b>Order Text</b>	4DI; 24 VAC/VDC; 20ms	4DI; 24 VAC/VDC; 20ms

<b>Item Description</b>	<b>4-Channel Digital Input; 24 VAC/DC; 50 ms</b>	
<b>Version</b>	<b>Standard</b>	<b>Pluggable (delivery without connector)</b>
<b>Item No.</b>	750-423	753-423
<b>Order Text</b>	4DI; 24 VAC/VDC; 50ms	4DI; 24 VAC/VDC; 50ms

<b>Item Description</b>	<b>4-Channel Digital Input; 24 VAC/DC; 50 ms</b>	
<b>Version</b>	<b>Standard</b>	<b>Pluggable (delivery without connector)</b>
<b>Item No.</b>	750-423	753-423
<b>Order Text</b>	4DI; 24 VAC/VDC; 50ms	4DI; 24 VAC/VDC; 50ms

<b>Technical Data</b>	
Pluggable connector	•
Number of digital inputs	4
Signal type	24 VAC/DC
Voltage range for signal (0)	-3 ... +5 VDC; 0 ... 5 VAC
Voltage range for signal (1)	11 ... 30 VDC; 10 ... 27 VAC
Sensor connection	2-wire
Input characteristic	High-side switching
Input filter (digital)	20 ms
Input current (typ.) at 24 VDC	7.5 mA
Input current (typ.) at 24 VAC	9.5 mA
Supply voltage (sensor)	24 VAC/DC
Supply voltage (field)	24 V AC/DC (-15 ... +20 %); via power jumper contacts (power supply via blade contact; transmission via spring contact)

Pluggable connector	•
Number of digital inputs	4
Signal type	24 VAC/DC
Voltage range for signal (0)	-3 ... +5 VDC; 0 ... 5 VAC
Voltage range for signal (1)	11 ... 30 VDC; 10 ... 27 VAC
Sensor connection	2-wire
Input characteristic	High-side switching
Input filter (digital)	20 ms
Input current (typ.) at 24 VDC	7.5 mA
Input current (typ.) at 24 VAC	9.5 mA
Supply voltage (sensor)	24 VAC/DC
Supply voltage (field)	24 V AC/DC (-15 ... +20 %); via power jumper contacts (power supply via blade contact; transmission via spring contact)

Pluggable connector	•
Number of digital inputs	4
Signal type	24 VAC/DC
Voltage range for signal (0)	-3 ... +5 VDC; 0 ... 5 VAC
Voltage range for signal (1)	11 ... 30 VDC; 10 ... 27 VAC
Sensor connection	2 x (2-wire; 3-wire)*
Input characteristic	High-side switching
Input filter (digital)	50 ms
Input current (typ.) at 24 VDC	7.5 mA
Input current (typ.) at 24 VAC	9.5 mA
Supply voltage (sensor)	24 VAC/DC
Supply voltage (field)	24 V AC/DC (-15 ... +20 %); via power jumper contacts (power supply via blade contact; transmission via spring contact)

Current consumption – system supply (5 V)	10 mA
Data width (internal)	4 bits
Isolation	500 V (system/field); 50 V (channel/channel)
Surrounding air temperature (operation)	0 ... +55 °C
Dimensions W x H x D	12 x 69.8 x 100 mm

Current consumption – system supply (5 V)	10 mA
Data width (internal)	4 bits
Isolation	500 V (system/field); 50 V (channel/channel)
Surrounding air temperature (operation)	0 ... +55 °C
Dimensions W x H x D	12 x 69.8 x 100 mm

Current consumption – system supply (5 V)	10 mA
Data width (internal)	4 bits
Isolation	500 V system/field
Surrounding air temperature (operation)	0 ... +55 °C
Dimensions W x H x D	12 x 69.8 x 100 mm

<b>Approvals</b>	CE; Marine; OrdLoc/HazLoc; ATEX/IECEX
------------------	---------------------------------------

<b>Approvals</b>	CE; Marine; OrdLoc/HazLoc; ATEX/IECEX
------------------	---------------------------------------

<b>Approvals</b>	CE; Marine; OrdLoc/HazLoc; ATEX/IECEX
------------------	---------------------------------------

<b>Data sheet and further information, see:</b>	wago.com/750-415	wago.com/753-415
---	------------------	------------------

<b>Data sheet and further information, see:</b>	wago.com/750-423	wago.com/753-423
---	------------------	------------------

<b>Data sheet and further information, see:</b>	wago.com/750-423	wago.com/753-423
---	------------------	------------------

<b>Accessories</b>	
Pluggable connector	Item No. 753-110
Coding keys	753-150

<b>Accessories</b>	
Pluggable connector	Item No. 753-110
Coding keys	753-150

<b>Accessories</b>	
Pluggable connector	Item No. 753-110
Coding keys	753-150

Notice:  
An additional supply module must be added for 24 VAC supply!

\*A suitable field side connection module (e.g., 750-614) must also be used to connect other sensors.

## Digital Input; 42 VAC/DC



Figure: 750-428

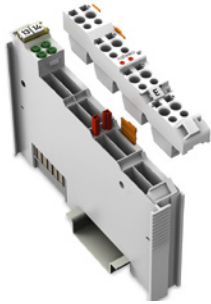
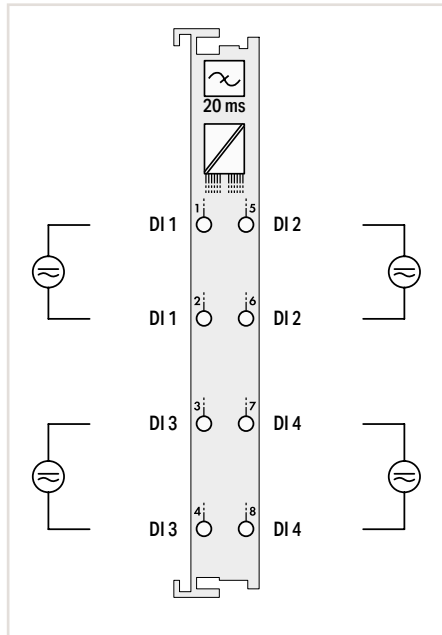


Figure: 753-428



Item Description		4-Channel Digital Input; 24 VAC/DC; 20 ms	
Version		Standard	Pluggable (delivery without connector)
Item No.	750-428	750-428	753-428
Order Text	4DI; 42 VAC/VDC; 20ms	4DI; 42 VAC/VDC; 20ms	4DI; 42 VAC/VDC; 20ms
<b>Technical Data</b>			
Pluggable connector			●
Number of digital inputs		4	
Signal type		42 VAC/VDC	
Voltage range for signal (0)		-3 ... +10 VDC; 0 ... 10 VAC	
Voltage range for signal (1)		30 ... 53 VDC; 30 ... 53 VAC	
Sensor connection		2-wire	
Input characteristic		High-side switching	
Input filter (digital)		20 ms	
Input current (typ.) at 42 VDC		3.6 mA	
Input current (typ.) at 42 VAC		6 mA	
Current consumption – system supply (5 V)		5 mA	
Data width (internal)		4 bits	
Isolation		500 V (system/field); 500 V (channel/channel)	
Surrounding air temperature (operation)		0 ... +55 °C	
Dimensions W x H x D		12 x 69.8 x 100 mm	
Approvals		CE, UL, OrdLoc/HazLoc, ATEX/IECEX	
Data sheet and further information, see:		<a href="http://wago.com/750-428">wago.com/750-428</a>	<a href="http://wago.com/753-428">wago.com/753-428</a>
<b>Accessories</b>		<b>Item No.</b>	
Pluggable connector		753-110	
Coding keys		753-150	

„ Mini-WSB marker card and mounting accessories, see Section "Accessories and Tools"  
 „ Approvals and corresponding ratings, see page 518 or www.wago.com

## Digital Input; 48 VDC



Figure: 750-412

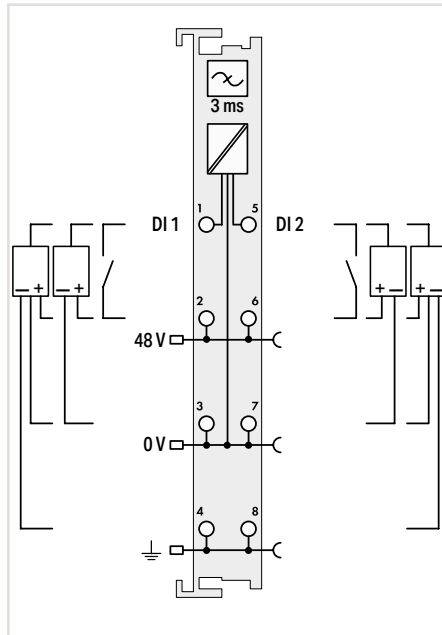


Figure: 753-412

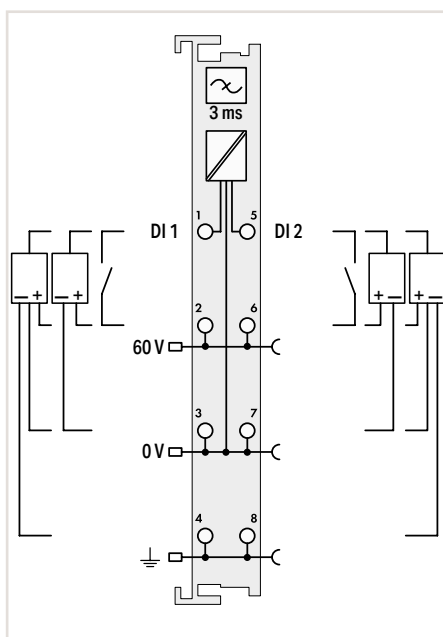
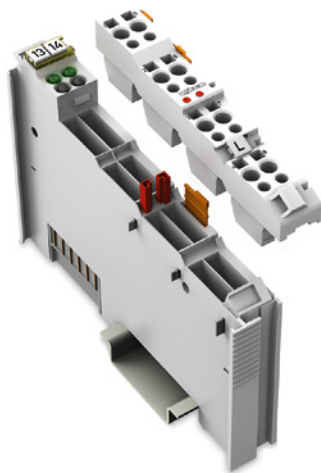
Item Description	2-Channel Digital Input; 48 VDC; 3 ms	
Version	Standard	Pluggable (delivery without connector)
Item No.	750-412	753-412
Order Text	2DI; 48 VDC; 3ms	2DI; 48 VDC; 3ms

Technical Data	
Pluggable connector	●
Number of digital inputs	2
Signal type	48 VDC
Voltage range for signal (0)	-6 ... +10 VDC
Voltage range for signal (1)	34 ... 60 VDC
Sensor connection	2-wire; 3-wire; 4-wire
Input characteristic	High-side switching
Input filter (digital)	3 ms
Input current per channel for signal (1) typ.	3.8 mA
Supply voltage (sensor)	48 VDC
Supply voltage (field)	48 VDC (-15 ... +20 %); via power jumper contacts (power supply via blade contact; transmission via spring contact)
Current consumption – system supply (5 V)	2.5 mA
Data width (internal)	2 bits
Isolation	500 V system/field
Surrounding air temperature (operation)	0 ... +55 °C
Dimensions W x H x D	12 x 69.8 x 100 mm
Approvals	CE; OrdLoc/HazLoc; ATEX/IECEX
Data sheet and further information, see:	<a href="http://wago.com/750-412">wago.com/750-412</a>   <a href="http://wago.com/753-412">wago.com/753-412</a>

Accessories	Item No.
Pluggable connector	753-110
Coding keys	753-150

**Notice:**  
An additional supply module must be added for 48 VDC supply!

## Digital Input; 60 VDC



<b>Item Description</b>	<b>2-Channel Digital Input; 60 VDC; 3 ms</b>
<b>Version</b>	<b>Pluggable (delivery without connector)</b>
<b>Item No.</b>	<b>753-429</b>
<b>Order Text</b>	<b>2DI; 60 VDC; 3ms</b>
<b>Technical Data</b>	
Pluggable connector	●
Number of digital inputs	2
Signal type	60 VDC
Voltage range for signal (0)	-7.5 ... +12 VDC
Voltage range for signal (1)	44 ... 75 VDC
Sensor connection	2-wire; 3-wire; 4-wire
Input characteristic	High-side switching
Input filter (digital)	3 ms
Input current per channel for signal (1) typ.	2.9 mA
Supply voltage (sensor)	60 VDC
Supply voltage (field)	60 VDC (-20 ... +25 %); via power jumper contacts (power supply via blade contact; transmission via spring contact)
Current consumption – system supply (5 V)	2.5 mA
Data width (internal)	2 bits
Isolation	500 V system/field
Surrounding air temperature (operation)	0 ... +55 °C
Dimensions W x H x D	12 x 69.8 x 100 mm
<b>Approvals</b>	CE; UL; OrdLoc/HazLoc; ATEX/IECEx
<b>Data sheet and further information, see:</b>	<a href="http://wago.com/753-429">wago.com/753-429</a>
<b>Accessories</b>	<b>Item No.</b>
Pluggable connector	753-110
Coding keys	753-150

**Notice:**  
An additional supply module must be added for 60 VDC supply!

„ Mini-WSB marker card and mounting accessories, see Section "Accessories and Tools"

„ Approvals and corresponding ratings, see page 518 or [www.wago.com](http://www.wago.com)

## Digital Input, 110 VDC or 220 VDC



Figure: 750-427

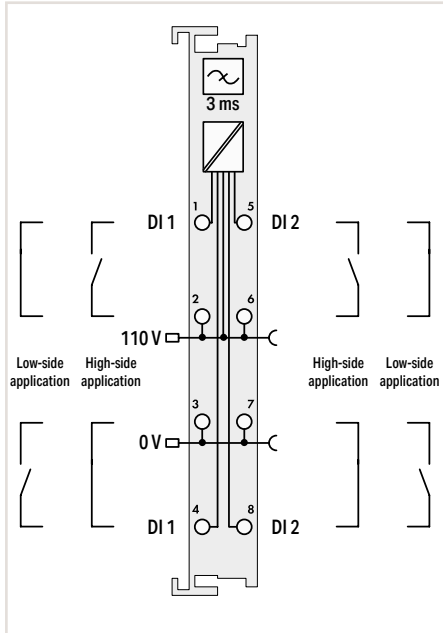
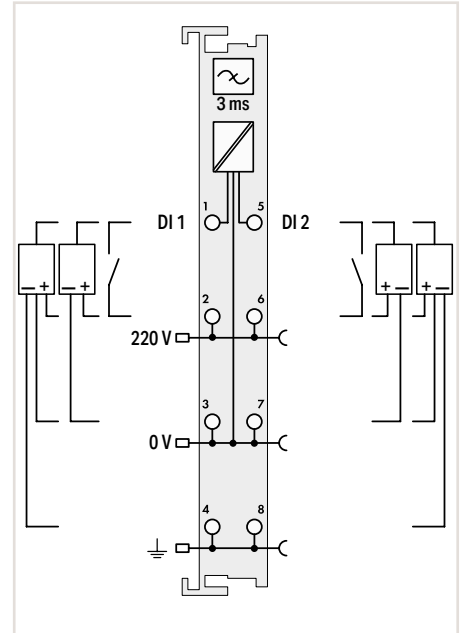


Figure: 750-407



Item Description
Version
Item No.
Order Text

2-Channel Digital Input; 110 VDC	
Standard	Pluggable (delivery without connector)
750-427	753-427
2DI; 110 VDC	2DI; 110 VDC

2-Channel Digital Input; 220 VDC	
Standard	
750-407	
2DI; 220 VDC	

Technical Data	
Pluggable connector	
Number of digital inputs	2
Signal type	110 VDC
Voltage range for signal (0)	-14 ... +50 VDC
Voltage range for signal (1)	-70 ... +143 VDC
Sensor connection	2-wire
Input characteristic	High-side/low-side switching; configurable
Input filter (digital)	3 ms
Input current per channel for signal (1) typ.	2.5 mA
Supply voltage (sensor)	110 VDC
Supply voltage (field)	110 VDC (-20 ... +25 %); via power jumper contacts (power supply via blade contact; transmission via spring contact)
Current consumption – system supply (5 V)	2.5 mA
Data width (internal)	2 bits
Isolation	1500 V (system/field)
Surrounding air temperature (operation)	0 ... +55 °C
Dimensions W x H x D	12 x 69.8 x 100 mm
Approvals	CE, UL, OrdLoc/HazLoc, ATEX/IECEX
Data sheet and further information, see:	<a href="http://wago.com/750-427">wago.com/750-427</a> <a href="http://wago.com/753-427">wago.com/753-427</a>

	●
	2
	110 VDC
	-14 ... +50 VDC
	-70 ... +143 VDC
	2-wire
	High-side/low-side switching; configurable
	3 ms
	2.5 mA
	110 VDC
	110 VDC (-20 ... +25 %); via power jumper contacts (power supply via blade contact; transmission via spring contact)
	2.5 mA
	2 bits
	1500 V (system/field)
	0 ... +55 °C
	12 x 69.8 x 100 mm
	CE, UL, OrdLoc/HazLoc, ATEX/IECEX
	<a href="http://wago.com/750-427">wago.com/750-427</a> <a href="http://wago.com/753-427">wago.com/753-427</a>

	2
	220 VDC
	-3 ... +100 VDC
	160 ... 286 VDC
	2-wire; 3-wire; 4-wire
	High-side switching
	3 ms
	1.2 mA
	220 VDC
	220 VDC (-20 ... +25 %); via power jumper contacts (power supply via blade contact; transmission via spring contact)
	5 mA
	2 bits
	2500 V (system/field)
	0 ... +55 °C
	12 x 69.8 x 100 mm
	CE, UL, OrdLoc
	<a href="http://wago.com/750-407">wago.com/750-407</a>

Accessories	
Pluggable connector	
Coding keys	

	Item No.
Pluggable connector	753-110
Coding keys	753-150

Notice:  
An additional supply module must be added for 110 VDC supply!

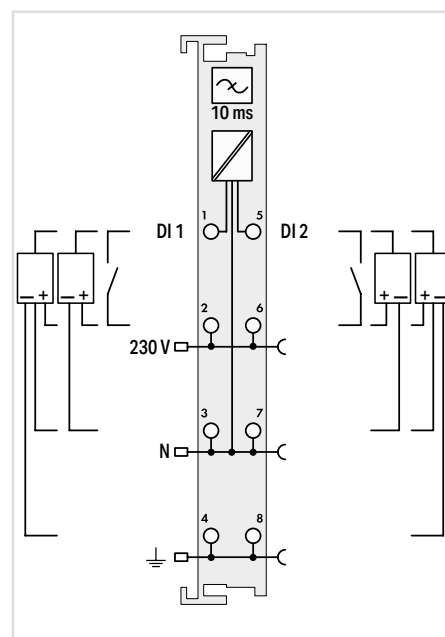
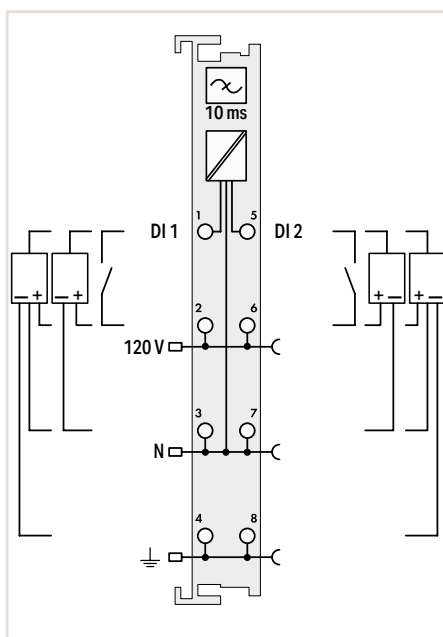
Notice:  
An additional supply module must be added for 220 VDC supply!

## Digital Input; 120 or 230 VAC



Figure: 750-406

Figure: 753-406



Item Description	2-Channel Digital Input; 120 VAC		2-Channel Digital Input; 230 VAC	
Version	Standard	Pluggable (delivery without connector)	Standard	Pluggable (delivery without connector)
Item No.	750-406	753-406	750-405	753-405
Order Text	2DI; 120 VAC	2DI; 120 VAC	2DI; 230 VAC	2DI; 230 VAC

Technical Data	2-Channel Digital Input; 120 VAC		2-Channel Digital Input; 230 VAC	
Pluggable connector		•		•
Number of digital inputs	2		2	
Signal type	120 VAC		230 VAC	
Voltage range for signal (0)	0 ... 20 VAC		0 ... 40 VAC	
Voltage range for signal (1)	79 VAC ... 1.1 U <sub>N</sub>		164 VAC ... 1.1 U <sub>N</sub>	
Sensor connection	2-wire; 3-wire; 4-wire		2-wire; 3-wire; 4-wire	
Input characteristic	High-side switching		High-side switching	
Input filter (digital)	10 ms		10 ms	
Signal frequency (min./max.)	45 Hz/65 Hz		45 Hz/65 Hz	
Input current per channel for signal (1) typ.	4.5 mA		6.5 mA	
Supply voltage (sensor)	120 VAC		230 VAC	
Supply voltage (field)	120 VAC (-15 ... +20 %); via power jumper contacts (power supply via blade contact; transmission via spring contact)		230 VAC (-15 ... +20 %); via power jumper contacts (power supply via blade contact; transmission via spring contact)	
Current consumption – system supply (5 V)	2 mA		2 mA	
Data width (internal)	2 bits		2 bits	
Isolation	1500 V (system/field)		1500 V (system/field)	
Surrounding air temperature (operation)	0 ... +55 °C		0 ... +55 °C	
Dimensions W x H x D	12 x 69.8 x 100 mm		12 x 69.8 x 100 mm	
Approvals	CE;  Marine;  OrdLoc/HazLoc;  ATEX/IECEx		CE;  Marine;  OrdLoc/HazLoc;  ATEX/IECEx	
Data sheet and further information, see:	<a href="http://wago.com/750-406">wago.com/750-406</a>	<a href="http://wago.com/753-406">wago.com/753-406</a>	<a href="http://wago.com/750-405">wago.com/750-405</a>	<a href="http://wago.com/753-405">wago.com/753-405</a>

Accessories	Item No.
Pluggable connector	753-110
Coding keys	753-150

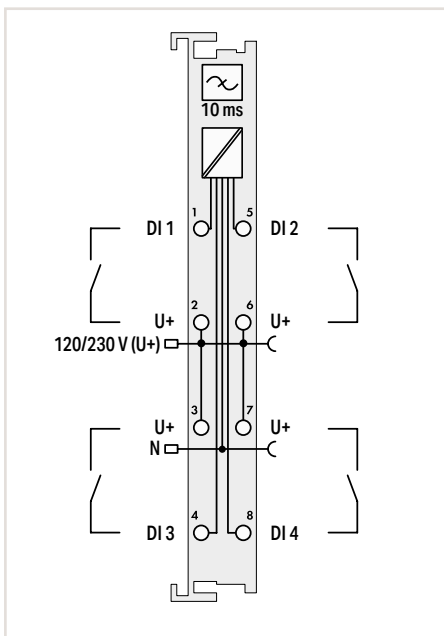
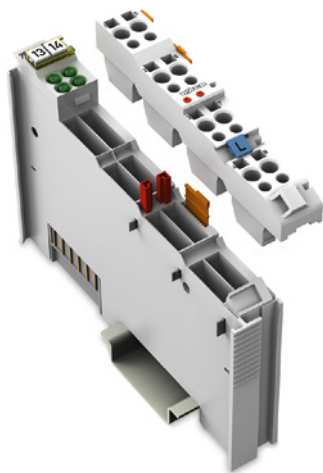
Notice:  
An additional supply module must be added for 120 VAC supply!

Notice:  
An additional supply module must be added for 230 VAC supply!

„ Mini-WSB marker card and mounting accessories, see Section "Accessories and Tools"

„ Approvals and corresponding ratings, see page 518 or [www.wago.com](http://www.wago.com)

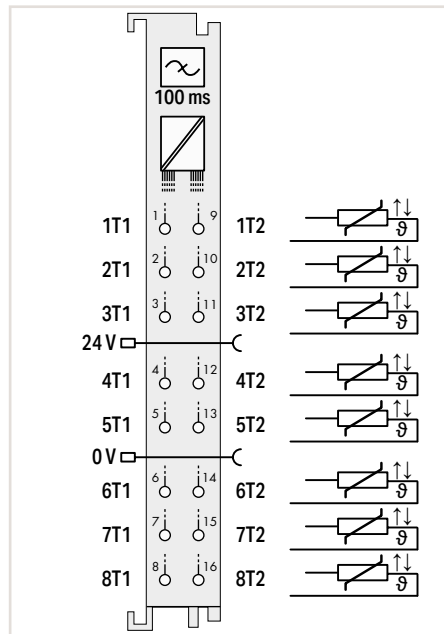
## Digital Input; 120 / 230 VAC



<b>Item Description</b>	<b>4-Channel Digital Input; 120/230 VAC</b>
<b>Version</b>	<b>Pluggable (delivery without connector)</b>
<b>Item No.</b>	<b>753-440</b>
<b>Order Text</b>	<b>4DI; 120/230 VAC</b>
<b>Technical Data</b>	
Pluggable connector	●
Number of digital inputs	4
Signal type	120 (230) VAC
Voltage range for signal (0)	0 ... 40 VAC
Voltage range for signal (1)	79 ... 230 VAC (-15 ... +10 %)
Sensor connection	2-wire
Input characteristic	High-side switching
Input filter (digital)	10 ms
Signal frequency (min./max.)	45 Hz/65 Hz
Overvoltage protection	275 VAC (varistor)
Input current (typ.) at 120 VAC	2.3 mA
Input current (typ.) at 230 VAC	4.7 mA
Supply voltage (sensor)	230 VAC
Supply voltage (field)	90 ... 230 VAC (-15 ... +10 %); via power jumper contacts (power supply via blade contact; transmission via spring contact)
Current consumption – system supply (5 V)	15 mA
Data width (internal)	4 bits
Isolation	1500 V (system/field)
Surrounding air temperature (operation)	0 ... +55 °C
Dimensions W x H x D	12 x 69.8 x 100 mm
<b>Approvals</b>	CE;  OrdLoc/HazLoc;  ATEX/IECEX
<b>Data sheet and further information, see:</b>	<a href="http://wago.com/753-440">wago.com/753-440</a>
<b>Accessories</b>	<b>Item No.</b>
Pluggable connector	753-110
Coding keys	753-150

Notice:  
An additional supply module must be added for 120/230 VAC supply!

## Digital Input; PTC



<b>Item Description</b>	<b>8-Channel Digital Input; PTC</b>
<b>Version</b>	<b>Standard with 16 connectors</b>
<b>Item No.</b>	<b>750-1425</b>
<b>Order Text</b>	<b>8DI; PTC</b>
<b>Technical Data</b>	
Number of digital inputs	8
Signal type	PTC; Thermistor per DIN 44081/44082
Sensor	Sensor voltage: $\leq 2.5 \text{ V} / \leq 7.5 \text{ V}$ (dependent on resistance value); Number of PTCs per channel: Max. 6 in a series; Operating value (status bit "1" to "0"): $R \geq 3 \text{ k}\Omega$ ; Return value (status bit "0" to "1"): $\leq 1.5 \text{ k}\Omega$ ; Hysteresis: $R = 1.5 \text{ k}\Omega$ ; Wire break value: $R \geq 8 \text{ k}\Omega$ ; Short circuit value: $R \leq 20 \Omega$
Input filter (digital)	100 ms
Output current (max.)	0.001 A
Supply voltage (field)	24 VDC (-25 ... +30 %); via power jumper contacts (power supply via blade contact; transmission via spring contact)
Current consumption – system supply (5 V)	52 mA
Data width (internal)	16 bits
Isolation	500 V system/field
Surrounding air temperature (operation)	0 ... +55 °C
Dimensions W x H x D	12 x 69 x 100 mm
<b>Approvals</b>	CE; Marine; OrdLoc/HazLoc; ATEX/IECEX
<b>Data sheet and further information, see:</b>	<a href="http://wago.com/750-1425">wago.com/750-1425</a>

The PTC module is used to connect PTC thermistors according to DIN 44081 and DIN 44082 for thermal monitoring (overload protection) of motors, machinery, bearings, etc. Up to six PTC thermistors can be connected in series per channel. If the nominal response temperature ( $\vartheta_{\text{nat}}$ ) is exceeded, a bit is set in the module's input process image. In addition, wire breaks and short circuits are monitored for each channel. If an error occurs, a bit is also set in the input process image. One green and one red status LED per channel indicate an overtemperature or wiring errors.

„ Mini-WSB marker card and mounting accessories, see Section "Accessories and Tools"

„ Approvals and corresponding ratings, see page 518 or [www.wago.com](http://www.wago.com)



5.2

# Digital Output Modules



## Housing design (750 Series)

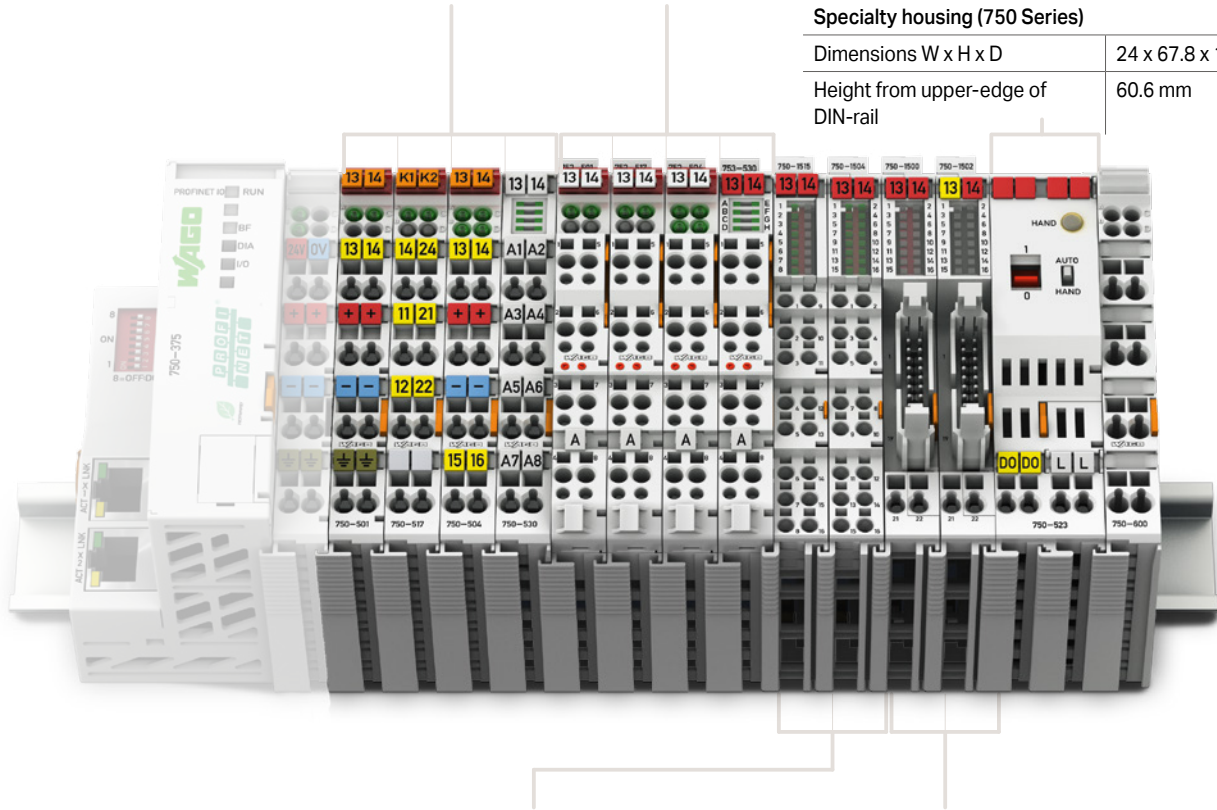
Dimensions W x H x D	Housing with 4 LEDs: 12 x 69.8 x 100 mm Housing with 8 LEDs: 12 x 67.8 x 100 mm
Height from upper-edge of DIN-rail	Housing with 4 LEDs: 62.6 mm Housing with 8 LEDs: 60.6 mm
Connection technology	CAGE CLAMP®
Conductor cross section	0.08 ... 2.5 mm <sup>2</sup> / 28 ... 14 AWG
Strip length	8 ... 9 mm / 0.33 inch

## Housing design (753 Series)

Dimensions W x H x D	Housing with 4 LEDs: 12 x 69.8 x 100 mm Housing with 8 LEDs: 12 x 69 x 100 mm
Height from upper-edge of DIN-rail	Housing with 4 LEDs: 62.6 mm Housing with 8 LEDs: 61.8 mm
Connection technology	CAGE CLAMP®
Conductor cross section	0.08 ... 2.5 mm <sup>2</sup> / 28 ... 14 AWG
Strip length	9 ... 10 mm / 0.37 inch

## Specialty housing (750 Series)

Dimensions W x H x D	24 x 67.8 x 100 mm
Height from upper-edge of DIN-rail	60.6 mm



## Housing design (750 Series), with Push-in CAGE CLAMP® connections (up to 16 connection points)

Dimensions W x H x D	12 x 69 x 100 mm
Height from upper-edge of DIN-rail	61.8 mm
Connection technology	Push-in CAGE CLAMP®
Conductor cross section	Solid: 0.08 ... 1.5 mm <sup>2</sup> / 28 ... 16 AWG Fine-stranded: 0.25 ... 1.5 mm <sup>2</sup> / 22 ... 16 AWG
Strip length	8 ... 9 mm / 0.33 inch

## Housing design (750 Series), with ribbon cable connection

Dimensions W x H x D	12 x 74.1 x 100 mm
Height from upper-edge of DIN-rail	66.9 mm
Connection technology	20-pole male connector + 2 x CAGE CLAMP®
Conductor cross section	0.08 ... 2.5 mm <sup>2</sup> / 28 ... 14 AWG
Strip length	8 ... 9 mm / 0.33 inch



I/O System – 750 XTR Series

# I/O System – 750 and 753 Series, Digital Output Modules Contents

Function	1-Channel DO	2-Channel DO	4-Channel DO	8-Channel DO	8-Channel DIO	16-Channel DO	Description	Item Number			Page	
								Standard	Extended Temperature	Pluggable		
5 VDC			■				4-Channel Digital Output; 5 VDC; 20 mA	750-519			194	
5/12 VDC				■			8-Channel Digital Output; 12 VDC; 1 A	750-534		753-534	194	
24 VDC	■						2-Channel Digital Output; 24 VDC; 0.5 A	750-501		753-501	195	
	■						2-Channel Digital Output; 24 VDC; 0.5 A; Interference-free	750-501/000-800		753-501/000-800	195	
	■						2-Channel Digital Output; 24 VDC; 2.0 A	750-502		753-502	196	
	■						2-Channel Digital Output; 24 VDC; 2.0 A; Interference-free	750-502/000-800		753-502/000-800	196	
	■						2-Channel Digital Output; 24 VDC; 0.5 A; Diagnostics	750-506		753-506	197	
	■						2-Channel Digital Output; 24 VDC; 0.5 A; Interference-free; Diagnostics	750-506/000-800			197	
	■						2-Channel Digital Output; 24 VDC; 2.0 A; Diagnostics	750-508*		753-508	197	
	■						2-Channel Digital Output; 24 VDC; 2.0 A; Interference-free; Diagnostics	750-508/000-800			197	
		■						4-Channel Digital Output; 24 VDC; 0.5 A	750-504	750-504/025-000	753-504	198
		■						4-Channel Digital Output; 24 VDC; 0.5 A; Interference-free	750-504/000-800	750-504/025-800		198
		■						4-Channel Digital Output; 24 VDC; 0.5 A; 2-wire connection	750-531		753-531	199
		■						4-Channel Digital Output; 24 VDC; 0.5 A; 2-wire connection; Interference-free	750-531/000-800		753-531/000-800	199
		■						4-Channel Digital Output; 24 VDC; 0.5 A; Low-side switching	750-516		753-516	200
		■						4-Channel Digital Output; 24 VDC; 0.5 A; Diagnostics	750-532			200
				■				8-Channel Digital Output; 24 VDC; 0.5 A	750-530	750-530/025-000	753-530	201
				■				8-Channel Digital Output; 24 VDC; 0.5 A; Low-side switching	750-536		753-536	201
				■				8-Channel Digital Output; 24 VDC; 0.5 A; Diagnostics	750-537*		753-537	201
				■				8-Channel Digital Output; 24 VDC; 0.5 A; 2-wire connection	750-1515*			202
				■				8-Channel Digital Output; 24 VDC; 0.5 A; Low-side switching; 2-wire connection	750-1516			202
					■			8-Channel Digital Input/Output; 24 VDC; 0.5 A; Ribbon cable	750-1502			203
				■			8-Channel Digital Input/Output; 24 VDC; 0.5 A	750-1506			203	
					■		16-Channel Digital Output; 24 VDC; 0.5 A; Ribbon cable	750-1500			204	
					■		16-Channel Digital Output; 24 VDC; 0.5 A	750-1504			204	
					■		16-Channel Digital Output; 24 VDC; 0.5 A; Low-side switching; Ribbon cable	750-1501			205	
					■		16-Channel Digital Output; 24 VDC; 0.5 A; Low-side switching	750-1505			205	
120/230 VAC			■				4-Channel Digital Output; 230 VAC; 0.25 A; Solid-state			753-540	206	
230 VAC/VDC	■						2-Channel Digital Output; 230 VAC; 0.3 A; Solid-state	750-509		753-509	206	
Relays	■						2-Channel Relay Output; 125 VAC; 0.5 A; Potential-free; 2 changeover contacts	750-514		753-514	207	
	■						2-Channel Relay Output; 250 VAC; 0.5 A; Potential-free; 2 changeover contacts	750-517*		753-517	208	
	■						2-Channel Relay Output; 250 VAC; 2.0 A; 2 make contacts	750-512		753-512	208	
	■						2-Channel Relay Output; 250 VAC; 2.0 A; Potential-free; 2 make contacts	750-513		753-513	209	
	■						2-Channel Relay Output; 250 VAC; 2.0 A; Potential-free; 2 make contacts; without power jumper contacts	750-513/000-001		753-513/000-001	209	
			■					4-Channel Relay Output; 250 VAC; 2.0 A; Potential-free; 4 make contacts	750-515			210
	■						1-Channel Relay Output; 250 VAC; 16 A; Potential-free; 1 make contact	750-523			211	
<b>Functional Safety</b>								See Section 5.8				
<b>Ex i</b>								See Section 5.9				
*This module is also available as a 750 XTR Series variant.								See Section 6				

## Digital Output; 5 or 12 VDC



Figure: 750-519

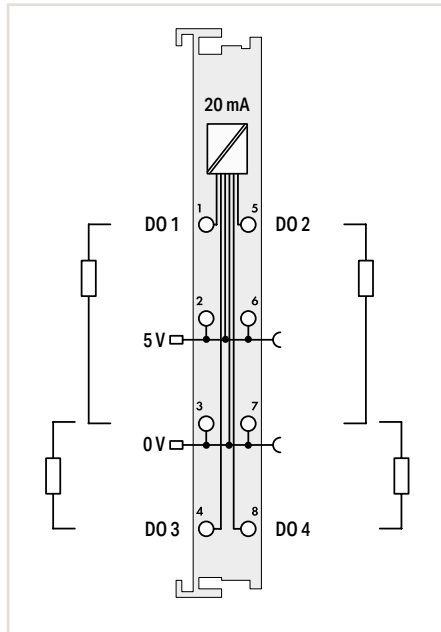
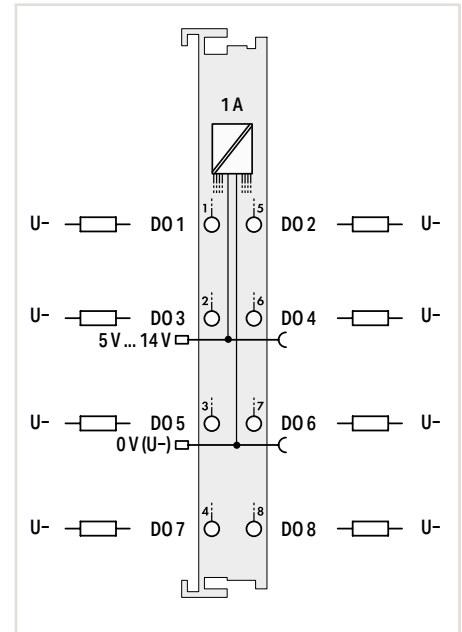


Figure: 753-534



<b>Item Description</b>
<b>Version</b>
<b>Item No.</b>
<b>Order Text</b>

<b>4-Channel Digital Output; 5 VDC; 20 mA</b>
<b>Standard</b>
<b>750-519</b>
<b>4DO; 5 VDC; 20mA</b>

<b>8-Channel Digital Output; 12 VDC; 1 A</b>
<b>Standard</b>
<b>750-534</b>
<b>8DO; 12 VDC; 1A</b>

<b>Technical Data</b>
Pluggable connector
Number of digital outputs
Signal type
Output characteristic
Output current per channel
Load type
Actuator connection
Switching frequency (max.)
Supply voltage (field)
Current consumption – system supply (5 V)
Data width (internal)
Isolation
Surrounding air temperature (operation)
Dimensions W x H x D
<b>Approvals</b>
<b>Data sheet and further information, see:</b>

4
5 VDC
High-side switching
20 mA; short-circuit-protected
Resistive; inductive; lamp load
2 x (2-wire)*
5 kHz
5 VDC; via power jumper contacts (power supply via blade contact; transmission via spring contact)
10 mA
4 bits
500 V (system/field)
0 ... +55 °C
12 x 69.8 x 100 mm
CE, UL, OrdLoc/HazLoc
<a href="http://wago.com/750-519">wago.com/750-519</a>

8
5 ... 14 VDC
High-side switching
1 A; short-circuit-protected
Resistive; inductive
1-wire
2 kHz
14 VDC; via power jumper contacts (power supply via blade contact; transmission via spring contact)
20 mA
8 bits
500 V (system/field)
0 ... +55 °C
12 x 67.8 x 100 mm   12 x 69 x 100 mm
CE, UL, Marine, OrdLoc/HazLoc; ATEX/IECEX
<a href="http://wago.com/750-534">wago.com/750-534</a>   <a href="http://wago.com/753-534">wago.com/753-534</a>

<b>Accessories</b>
Pluggable connector
Coding keys

<b>Item No.</b>
753-110
753-150

Notice:  
An additional supply module must be added for 5 VDC supply!

\*A suitable field side connection module (e.g., 750-614) must also be used to connect other actuators.

Notice:  
An additional supply module must be added for 5–14 VDC supply!

„ Mini-WSB marker card and mounting accessories, see Section "Accessories and Tools"

„ Approvals and corresponding ratings, see page 519 or [www.wago.com](http://www.wago.com)

## Digital Output; 24 VDC



Figure: 750-501

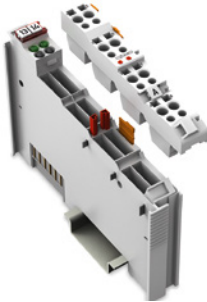
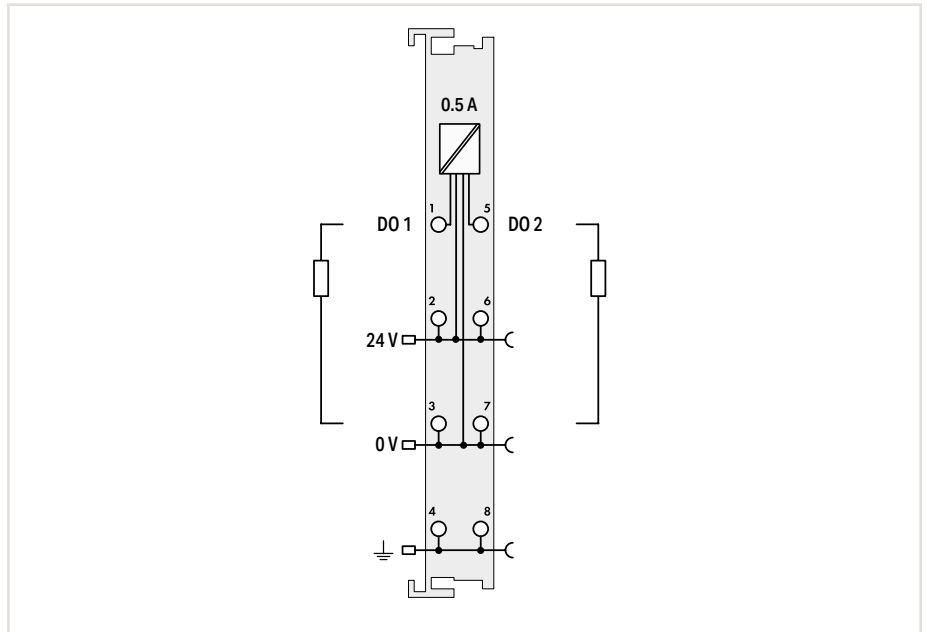


Figure: 753-501



Item Description	2-Channel Digital Output; 24 VDC; 0.5 A			
Version	Standard	Interference-free	Pluggable (delivery without connector)	Pluggable (delivery without connector); Interference-free
Item No.	750-501	750-501/000-800	753-501	753-501/000-800
Order Text	2DO; 24 VDC; 0.5A	2DO; 24 VDC; 0.5A; IF	2DO; 24 VDC; 0.5A	2DO; 24 VDC; 0.5A; IF

Technical Data	
Pluggable connector	•
Interference-free for use in safety functions	•
Number of digital outputs	2
Signal type	24 VDC
Output characteristic	High-side switching
Output current per channel	0.5 A; short-circuit-protected
Load type	Resistive; inductive; lamp load
Actuator connection	2-wire; 3-wire; 4-wire
Switching frequency (max.)	5 kHz
Supply voltage (field)	24 VDC (-25 ... +30 %); via power jumper contacts (power supply via blade contact; transmission via spring contact)
Current consumption – system supply (5 V)	3.5 mA
Data width (internal)	2 bits
Isolation	500 V (system/field)
Surrounding air temperature (operation)	0 ... +55 °C
Dimensions W x H x D	12 x 69.8 x 100 mm
Approvals	CE; Marine; OrdLoc/HazLoc; ATEX/IECEX
Data sheet and further information, see:	<a href="http://wago.com/750-501">wago.com/750-501</a>   <a href="http://wago.com/753-501">wago.com/753-501</a>
Accessories	
Pluggable connector	Item No. 753-110
Coding keys	753-150

## Digital Output; 24 VDC



Figure: 750-502

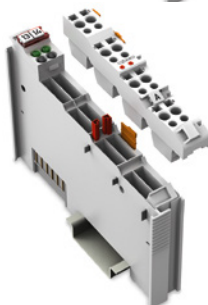
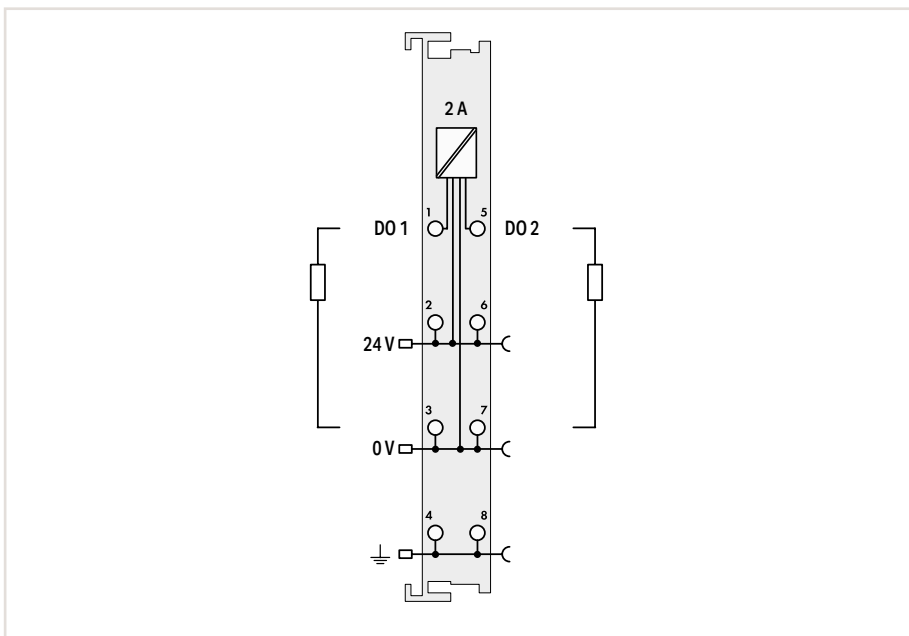


Figure: 753-502



Item Description		2-Channel Digital Output; 24 VDC; 2.0 A			
Version		Standard	Interference-free	Pluggable (delivery without connector)	Pluggable (delivery without connector); Interference-free
Item No.		750-502	750-502/000-800	753-502	753-502/000-800
Order Text		2DO; 24 VDC; 2A	2DO; 24 VDC; 2A; IF	2DO; 24 VDC; 2A	2DO; 24 VDC; 2A; IF
Technical Data					
Pluggable connector					•
Interference-free for use in safety functions			•		•
Number of digital outputs		2			
Signal type		24 VDC			
Output characteristic		High-side switching			
Output current per channel		2 A; short-circuit-protected			
Load type		Resistive; inductive; lamp load			
Actuator connection		2-wire; 3-wire; 4-wire			
Switching frequency (max.)		2.5 kHz			
Supply voltage (field)		24 VDC (-25 ... +30 %); via power jumper contacts (power supply via blade contact; transmission via spring contact)			
Current consumption – system supply (5 V)		3.5 mA			
Data width (internal)		2 bits			
Isolation		500 V (system/field)			
Surrounding air temperature (operation)		0 ... +55 °C			
Dimensions W x H x D		12 x 69.8 x 100 mm			
Approvals		CE; Marine; OrdLoc/HazLoc; ATEX/IECEX			
Data sheet and further information, see:		<a href="http://wago.com/750-502">wago.com/750-502</a>		<a href="http://wago.com/753-502">wago.com/753-502</a>	
Accessories		Item No.			
Pluggable connector		753-110			
Coding keys		753-150			

„ Mini-WSB marker card and mounting accessories, see Section "Accessories and Tools"  
 „ Approvals and corresponding ratings, see page 519 or [www.wago.com](http://www.wago.com)

## Digital Output; 24 VDC



Figure: 750-506

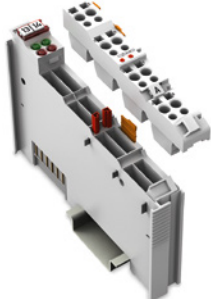
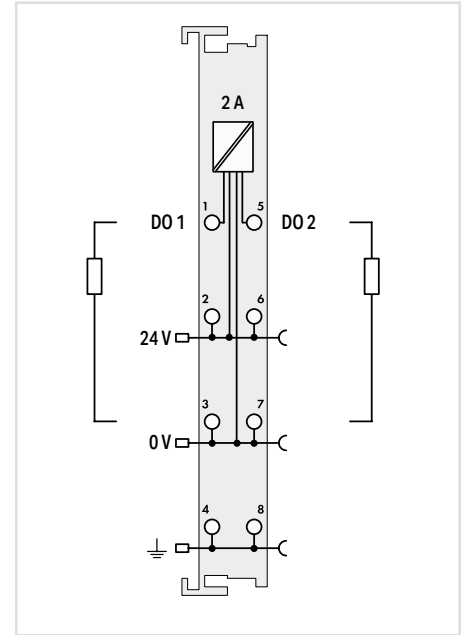
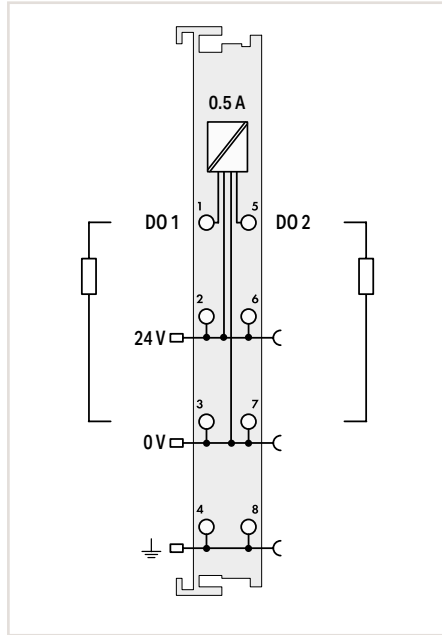


Figure: 753-506



<b>Item Description</b>	<b>2-Channel Digital Output; 24 VDC; 0.5 A; Diagnostics</b>		
<b>Version</b>	Standard      Interference-free      Pluggable (delivery without connector)		
<b>Item No.</b>	750-506	750-506/000-800	753-506
<b>Order Text</b>	2DO; 24 VDC; 0.5A; Diagn	2DO; 24 VDC; 0.5A; IF; Diagn	2DO; 24 VDC; 0.5A; Diagn

<b>Item Description</b>	<b>2-Channel Digital Output; 24 VDC; 2.0 A; Diagnostics</b>		
<b>Version</b>	Standard      Interference-free      Pluggable (delivery without connector)		
<b>Item No.</b>	750-508	750-508/000-800	753-508
<b>Order Text</b>	2DO; 24 VDC; 2A; Diagn	2DO; 24 VDC; 2A; IF; Diagn	2DO; 24 VDC; 2A; Diagn

<b>Technical Data</b>	
Pluggable connector	●
Interference-free for use in safety functions	●
Number of digital outputs	2
Signal type	24 VDC
Output characteristic	High-side switching
Output current per channel	0.5 A; short-circuit-protected
Load type	Resistive; inductive; lamp load
Actuator connection	2-wire; 3-wire; 4-wire
Switching frequency (max.)	5 kHz
Diagnostics	Open circuit; short circuit; overload
Supply voltage (field)	24 VDC (-15 ... +20 %); via power jumper contacts (power supply via blade contact; transmission via spring contact)
Current consumption – system supply (5 V)	15 mA
Data width (internal)	2-bit input; 2-bit output
Isolation	500 V (system/field)
Surrounding air temperature (operation)	0 ... +55 °C
Dimensions W x H x D	12 x 69.8 x 100 mm
<b>Approvals</b>	CE; ;  OrdLoc/HazLoc;  ATEX/IECEx
<b>Data sheet and further information, see:</b>	<a href="http://wago.com/750-506">wago.com/750-506</a> <a href="http://wago.com/753-506">wago.com/753-506</a>
<b>Accessories</b>	<b>Item No.</b>
Pluggable connector	753-110
Coding keys	753-150

	●
	●
	2
	24 VDC
	High-side switching
	2 A; short-circuit-protected
	Resistive; inductive; lamp load
	2-wire; 3-wire; 4-wire
	1 kHz
	Open circuit; short circuit; overload
	24 VDC (-25 ... +30 %); via power jumper contacts (power supply via blade contact; transmission via spring contact)
	14 mA
	2-bit input; 2-bit output
	500 V (system/field)
	0 ... +55 °C
	12 x 69.8 x 100 mm
	CE; ;  Marine;  OrdLoc/HazLoc;  ATEX/IECEx
	<a href="http://wago.com/750-508">wago.com/750-508</a> <a href="http://wago.com/753-508">wago.com/753-508</a>
	<b>Item No.</b>
	753-110
	753-150

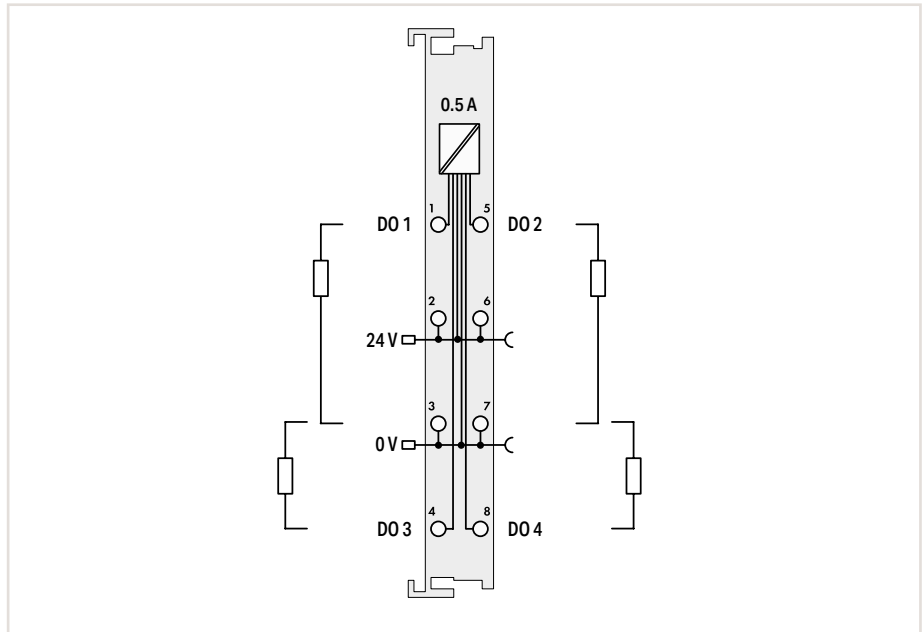
	●
	●
	2
	24 VDC
	High-side switching
	2 A; short-circuit-protected
	Resistive; inductive; lamp load
	2-wire; 3-wire; 4-wire
	1 kHz
	Open circuit; short circuit; overload
	24 VDC (-25 ... +30 %); via power jumper contacts (power supply via blade contact; transmission via spring contact)
	14 mA
	2-bit input; 2-bit output
	500 V (system/field)
	0 ... +55 °C
	12 x 69.8 x 100 mm
	CE; ;  Marine;  OrdLoc/HazLoc;  ATEX/IECEx
	<a href="http://wago.com/750-508">wago.com/750-508</a> <a href="http://wago.com/753-508">wago.com/753-508</a>
	<b>Item No.</b>
	753-110
	753-150

## Digital Output; 24 VDC



Figure: 750-504

Figure: 753-504



Item Description		4-Channel Digital Output; 24 VDC; 0.5 A				
Version		Standard	Extended temperature	Pluggable (delivery without connector)	Interference-free	Interference-free; Extended temperature
Item No.		750-504	750-504/025-000	753-504	750-504/000-800	750-504/025-800
Order Text		4DO; 24 VDC; 0.5A	4DO; 24 VDC; 0.5A; T	4DO; 24 VDC; 0.5A	4DO; 24 VDC; 0.5A; IF	4DO; 24 VDC; 0.5A; IF; T
Technical Data						
Pluggable connector		•				
Interference-free for use in safety functions		•				
Number of digital outputs		4				
Signal type		24 VDC				
Output characteristic		High-side switching				
Output current per channel		0.5 A; short-circuit-protected				
Load type		Resistive; inductive; lamp load				
Actuator connection		2 x (2-wire; 3-wire)*				
Switching frequency (max.)		1 kHz				
Supply voltage (field)		24 VDC (-25 ... +30 %); via power jumper contacts (power supply via blade contact; transmission via spring contact)				
Current consumption – system supply (5 V)		10 mA				
Data width (internal)		4 bits				
Isolation		500 V (system/field)				
Surrounding air temperature (operation)		0 ... +55 °C	-20 ... +60 °C	0 ... +55 °C	-20 ... +60 °C	
Dimensions W x H x D		12 x 69.8 x 100 mm				
Approvals		CE;  Marine;  OrdLoc/HazLoc;  ATEX/IECEX				
Data sheet and further information, see:		<a href="http://wago.com/750-504">wago.com/750-504</a>	<a href="http://wago.com/753-504">wago.com/753-504</a>	<a href="http://wago.com/750-504">wago.com/750-504</a>		
Accessories		Item No.				
Pluggable connector		753-110				
Coding keys		753-150				

\*A suitable field side connection module (e.g., 750-614) must also be used to connect other actuators.

„ Mini-WSB marker card and mounting accessories, see Section "Accessories and Tools"

„ Approvals and corresponding ratings, see page 519 or [www.wago.com](http://www.wago.com)

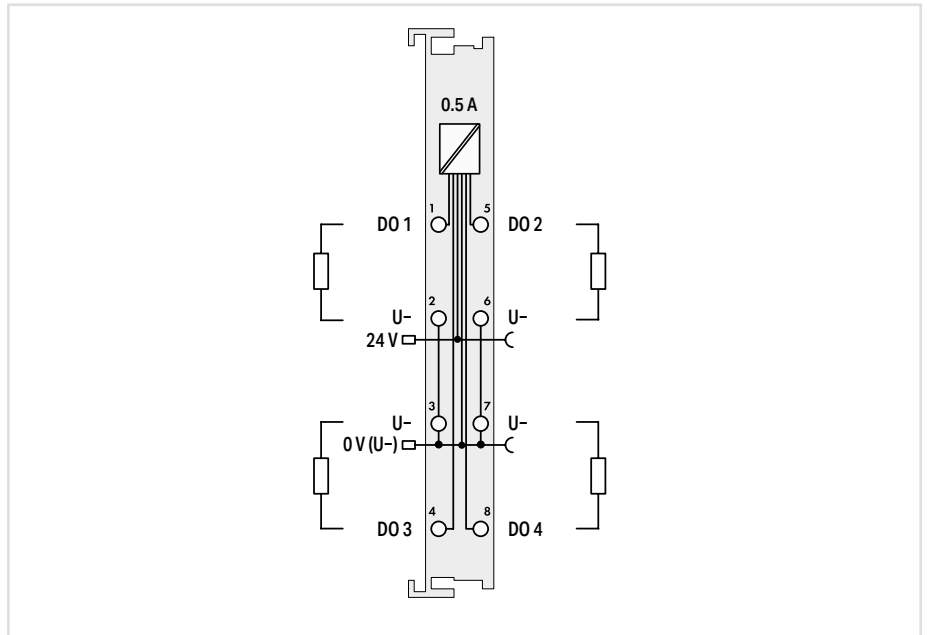


## Digital Output; 24 VDC



Figure: 750-531

Figure: 753-531



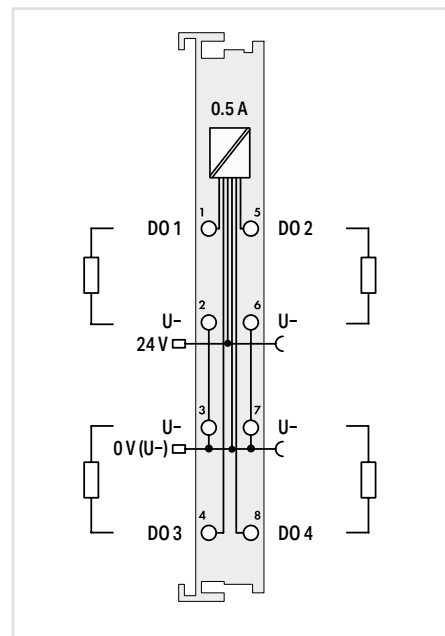
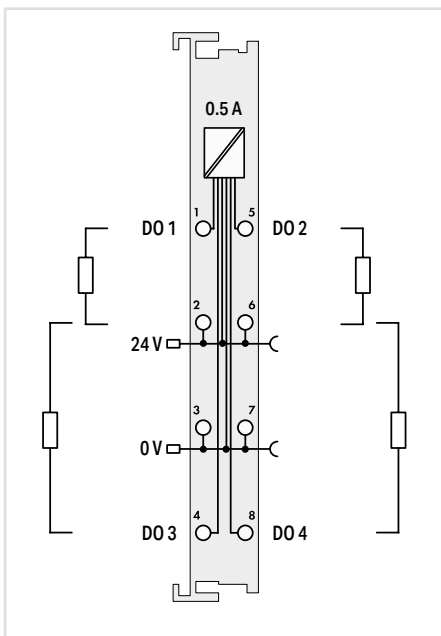
Item Description	4-Channel Digital Output; 24 VDC; 0.5 A; 2-wire connection			
Version	Standard	Interference-free	Pluggable (delivery without connector)	Pluggable (delivery without connector); Interference-free
Item No.	750-531	750-531/000-800	753-531	753-531/000-800
Order Text	4DO; 24 VDC; 0.5A; 2-wire	4DO; 24 VDC; 0.5A; IF; 2-wire	4DO; 24 VDC; 0.5A; 2-wire	4DO; 24 VDC; 0.5A; IF; 2-wire
<b>Technical Data</b>				
Pluggable connector				•
Interference-free for use in safety functions		•		•
Number of digital outputs	4			
Signal type	24 VDC			
Output characteristic	High-side switching			
Output current per channel	0.5 A; short-circuit-protected			
Load type	Resistive; inductive; lamp load			
Actuator connection	2-wire			
Switching frequency (max.)	1 kHz			
Supply voltage (field)	24 VDC (-25 ... +30 %); via power jumper contacts (power supply via blade contact; transmission via spring contact)			
Current consumption – system supply (5 V)	10 mA			
Data width (internal)	4 bits			
Isolation	500 V (system/field)			
Surrounding air temperature (operation)	0 ... +55 °C			
Dimensions W x H x D	12 x 69.8 x 100 mm			
Approvals	CE; Marine; OrdLoc/HazLoc; ATEX/IECEx			
Data sheet and further information, see:	<a href="http://wago.com/750-531">wago.com/750-531</a>		<a href="http://wago.com/753-531">wago.com/753-531</a>	
<b>Accessories</b>				
Pluggable connector				Item No. 753-110
Coding keys				753-150

## Digital Output; 24 VDC



Figure: 750-516

Figure: 753-532

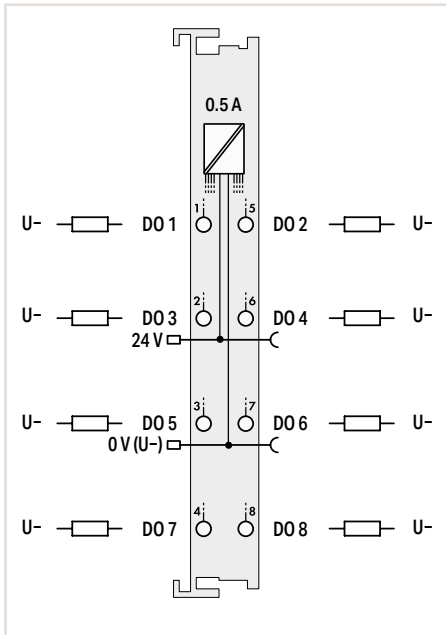


Item Description	4-Channel Digital Output; 24 VDC; 0.5 A; Low-side switching		4-Channel Digital Output; 24 VDC; 0.5 A; Diagnostics
Version	Standard	Pluggable (delivery without connector)	Standard
Item No.	750-516	753-516	750-532
Order Text	4DO; 24 VDC; 0.5A; LSS	4DO; 24 VDC; 0.5A; LSS	4DO; 24 VDC; 0.5A; Diagn
<b>Technical Data</b>			
Pluggable connector		●	
Number of digital outputs	4		4
Signal type	24 VDC		24 VDC
Output characteristic	Low-side switching		High-side switching
Output current per channel	0.5 A; short-circuit-protected		0.5 A; short-circuit-protected
Load type	Resistive; inductive; lamp load		Resistive; inductive; lamp load
Actuator connection	2 x (2-wire)*		2-wire
Switching frequency (max.)	5 kHz		2 kHz
Diagnostics			Open circuit; short circuit; overload
Supply voltage (field)	24 VDC (-25 ... +30 %); via power jumper contacts (power supply via blade contact; transmission via spring contact)		24 VDC (-25 ... +30 %); via power jumper contacts (power supply via blade contact; transmission via spring contact)
Current consumption – system supply (5 V)	7 mA		10 mA
Data width (internal)	4 bits		4-bit input; 4-bit output
Isolation	500 V (system/field)		500 V (system/field)
Surrounding air temperature (operation)	0 ... +55 °C		0 ... +55 °C
Dimensions W x H x D	12 x 69.8 x 100 mm		12 x 67.8 x 100 mm
Approvals	CE;  Marine;  OrdLoc/HazLoc;  ATEX/IECEX		CE;  Marine;  OrdLoc/HazLoc;  ATEX/IECEX
Data sheet and further information, see:	<a href="http://wago.com/750-516">wago.com/750-516</a>	<a href="http://wago.com/753-516">wago.com/753-516</a>	<a href="http://wago.com/750-532">wago.com/750-532</a>
<b>Accessories</b>			
Pluggable connector		Item No.	
Coding keys		753-110	
		753-150	

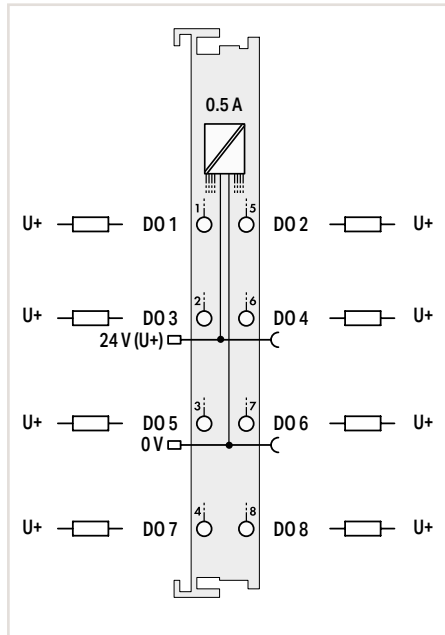
\*A suitable field side connection module (e.g., 750-614) must also be used to connect other actuators.

„ Mini-WSB marker card and mounting accessories, see Section "Accessories and Tools"

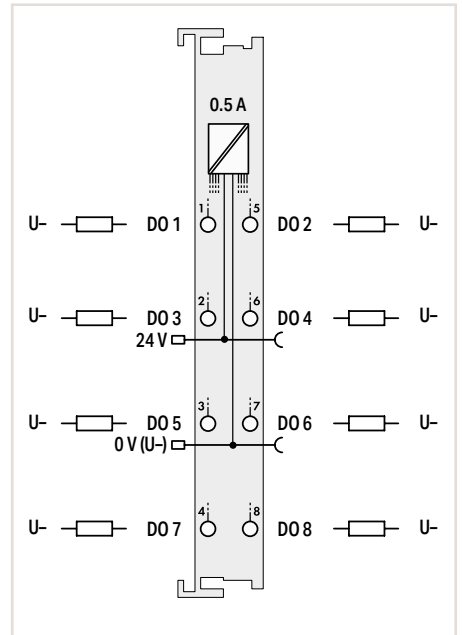
„ Approvals and corresponding ratings, see page 519 or [www.wago.com](http://www.wago.com)



8-Channel Digital Output; 24 VDC; 0.5 A		
Standard	Extended temperature	Pluggable (delivery without connector)
750-530	750-530/025-000	753-530
8DO; 24 VDC; 0.5A	8DO; 24 VDC; 0.5A; T	8DO; 24 VDC; 0.5A



8-Channel Digital Output; 24 VDC; 0.5 A; Low-side switching	
Standard	Pluggable (delivery without connector)
750-536	753-536
8DO; 24 VDC; 0.5A; LSS	8DO; 24 VDC; 0.5A; LSS



8-Channel Digital Output; 24 VDC; 0.5 A; Diagnostics	
Standard	Pluggable (delivery without connector)
750-537	753-537
8DO; 24 VDC; 0.5A; Diagn	8DO; 24 VDC; 0.5A; Diagn

8		•
24 VDC		
High-side switching		
0.5 A; short-circuit-protected		
Resistive; inductive; lamp load		
1-wire		
2 kHz		
24 VDC (-25 ... +30 %); via power jumper contacts (power supply via blade contact; transmission via spring contact)		
25 mA		
8 bits		
500 V (system/field)		
0 ... +55 °C	-20 ... +60 °C	0 ... +55 °C
12 x 67.8 x 100 mm	12 x 69 x 100 mm	
CE;  Marine;  OrdLoc/HazLoc;  ATEX/IECEx		
<a href="http://wago.com/750-530">wago.com/750-530</a>	<a href="http://wago.com/753-530">wago.com/753-530</a>	
	<b>Item No.</b>	
	753-110	
	753-150	

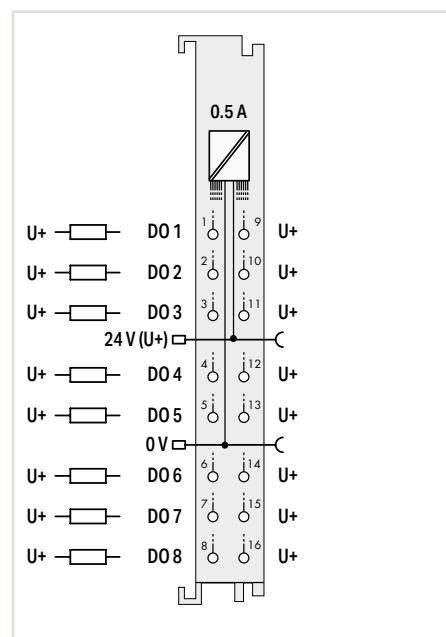
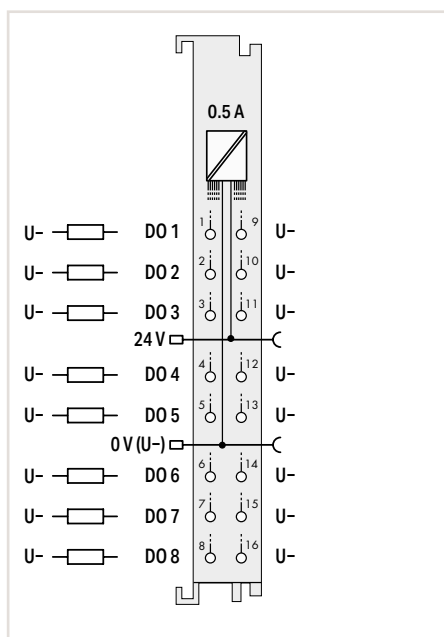
8		•
24 VDC		
Low-side switching		
0.5 A; short-circuit-protected		
Resistive; inductive; lamp load		
1-wire		
2 kHz		
24 VDC (-25 ... +30 %); via power jumper contacts (power supply via blade contact; transmission via spring contact)		
25 mA		
8 bits		
500 V (system/field)		
0 ... +55 °C		
12 x 67.8 x 100 mm	12 x 69 x 100 mm	
CE;  Marine;  OrdLoc/HazLoc;  ATEX/IECEx		
<a href="http://wago.com/750-536">wago.com/750-536</a>	<a href="http://wago.com/753-536">wago.com/753-536</a>	
	<b>Item No.</b>	
	753-110	
	753-150	

8		•
24 VDC		
High-side switching		
0.5 A; short-circuit-protected		
Resistive; inductive; lamp load		
1-wire		
1 kHz		
Open circuit; short circuit; overload		
24 VDC (-25 ... +30 %); via power jumper contacts (power supply via blade contact; transmission via spring contact)		
50 mA		
8-bit output; 8-bit input		
500 V (system/field)		
0 ... +55 °C		
12 x 67.8 x 100 mm	12 x 69 x 100 mm	
CE;  Marine;  OrdLoc/HazLoc;  ATEX/IECEx		
<a href="http://wago.com/750-537">wago.com/750-537</a>	<a href="http://wago.com/753-537">wago.com/753-537</a>	
	<b>Item No.</b>	
	753-110	
	753-150	

## Digital Output; 24 VDC



Figure: 750-1515



Item Description	8-Channel Digital Output; 24 VDC; 0.5 A; 2-wire connection	8-Channel Digital Output; 24 VDC; 0.5 A; Low-side switching; 2-wire connection
Version	Standard with 16 connectors	Standard with 16 connectors
Item No.	750-1515	750-1516
Order Text	8DO; 24 VDC; 0.5A; 2-wire	8DO; 24 VDC; 0.5A; LSS; 2-wire
<b>Technical Data</b>		
Number of digital outputs	8	8
Signal type	24 VDC	24 VDC
Output characteristic	High-side switching	Low-side switching
Output current per channel	0.5 A; short-circuit-protected	0.5 A; short-circuit-protected
Load type	Resistive; inductive; lamp load	Resistive; inductive; lamp load
Actuator connection	2-wire	2-wire
Switching frequency (max.)	1 kHz	1 kHz
Supply voltage (field)	24 VDC (-25 ... +30 %); via power jumper contacts (power supply via blade contact; transmission via spring contact)	24 VDC (-25 ... +30 %); via power jumper contacts (power supply via blade contact; transmission via spring contact)
Current consumption – system supply (5 V)	20 mA	20 mA
Data width (internal)	8 bits	8 bits
Isolation	500 V (system/field)	500 V (system/field)
Surrounding air temperature (operation)	0 ... +55 °C	0 ... +55 °C
Dimensions W x H x D	12 x 69 x 100 mm	12 x 69 x 100 mm
Approvals	CE;  Marine;  OrdLoc/HazLoc; ATEX/IECEX	CE;  Marine;  OrdLoc/HazLoc; ATEX/IECEX
Data sheet and further information, see:	<a href="http://wago.com/750-1515">wago.com/750-1515</a>	<a href="http://wago.com/750-1516">wago.com/750-1516</a>

# Digital Input/Output; 24 VDC



Figure: 750-1502

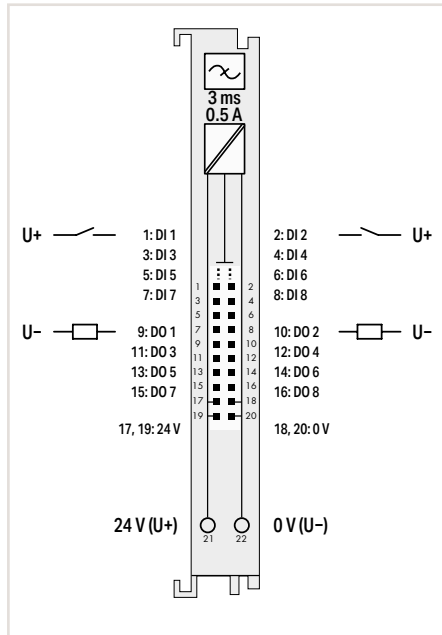
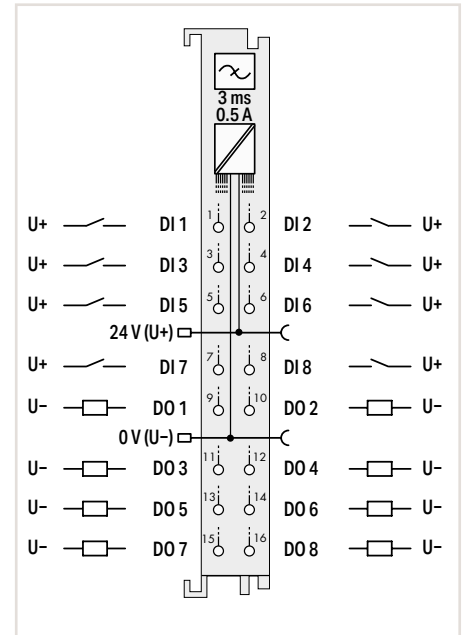


Figure: 750-1506



Item Description	8-Channel Digital Input/Output; 24 VDC; 0.5 A; Ribbon cable	8-Channel Digital Input/Output; 24 VDC; 0.5 A
Version	Standard with ribbon cable connector	Standard with 16 connectors
Item No.	750-1502	750-1506
Order Text	8DIO; 24 VDC; 0.5A; Ribbon Cable	8DIO; 24 VDC; 0.5A
<b>Technical Data</b>		
Number of digital inputs	8	8
Signal type	24 VDC	24 VDC
Voltage range for signal (0)	-3 ... +5 VDC	-3 ... +5 VDC
Voltage range for signal (1)	15 ... 30 VDC	15 ... 30 VDC
Sensor connection	1-wire	1-wire
Input characteristic	High-side switching	High-side switching
Input filter (digital)	3 ms	3 ms
Input current per channel for signal (1) typ.	2.4 mA	2.4 mA
Number of digital outputs	8	8
Output characteristic	High-side switching	High-side switching
Output current per channel	0.5 A; short-circuit-protected	0.5 A; short-circuit-protected
Load type	Resistive; inductive; lamp load	Resistive; inductive; lamp load
Actuator connection	1-wire	1-wire
Switching frequency (max.)	1 kHz	1 kHz
Current consumption, field supply (module with no external load)	16 mA	16 mA
Supply voltage (field)	24 VDC (-25 ... +30 %); via wiring interface (CAGE CLAMP® connection)	24 VDC (-25 ... +30 %); via power jumper contacts (power supply via blade contact; transmission via spring contact)
Current consumption – system supply (5 V)	30 mA	30 mA
Data width (internal)	8-bit input; 8-bit output	8-bit input; 8-bit output
Isolation	500 V (system/field)	500 V (system/field)
Surrounding air temperature (operation)	0 ... +55 °C	0 ... +55 °C
Dimensions W x H x D	12 x 74.1 x 100 mm	12 x 69 x 100 mm
Approvals	CE; Marine; OrdLoc/HazLoc; ATEX/IECEX	CE; Marine; OrdLoc/HazLoc; ATEX/IECEX
Data sheet and further information, see:	<a href="http://wago.com/750-1502">wago.com/750-1502</a>	<a href="http://wago.com/750-1506">wago.com/750-1506</a>
<b>Accessories</b>		
Interface modules for system wiring and interface cable	Item No. See Section 10	

## Digital Output; 24 VDC



Figure: 750-1500

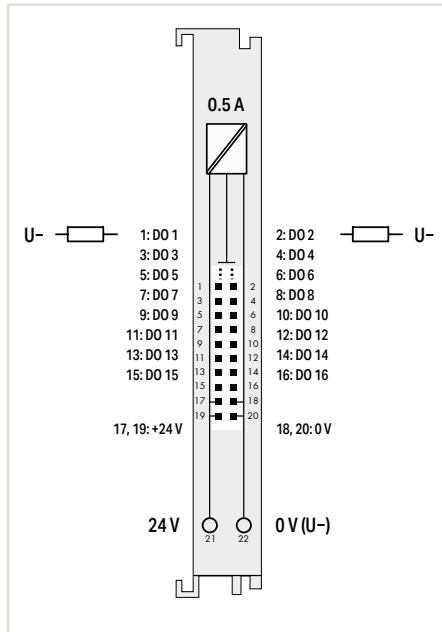
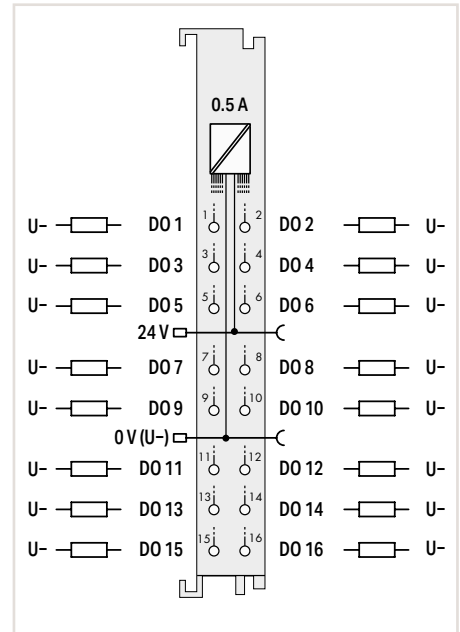


Figure: 750-1504



Item Description	16-Channel Digital Output; 24 VDC; 0.5 A; Ribbon cable	16-Channel Digital Output; 24 VDC; 0.5 A
Version	Standard with ribbon cable connector	Standard with 16 connectors
Item No.	750-1500	750-1504
Order Text	16DO; 24 VDC; 0.5A; Ribbon Cable	16DO; 24 VDC; 0.5A
<b>Technical Data</b>		
Number of digital outputs	16	16
Signal type	24 VDC	24 VDC
Output characteristic	High-side switching	High-side switching
Output current per channel	0.5 A; short-circuit-protected	0.5 A; short-circuit-protected
Load type	Resistive; inductive; lamp load	Resistive; inductive; lamp load
Actuator connection	1-wire	1-wire
Switching frequency (max.)	1 kHz	1 kHz
Supply voltage (field)	24 VDC (-25 ... +30 %); via wiring interface (CAGE CLAMP® connection)	24 VDC (-25 ... +30 %); via power jumper contacts (power supply via blade contact; transmission via spring contact)
Current consumption – system supply (5 V)	40 mA	40 mA
Data width (internal)	16 bits	16 bits
Isolation	500 V (system/field)	500 V (system/field)
Surrounding air temperature (operation)	0 ... +55 °C	0 ... +55 °C
Dimensions W x H x D	12 x 74.1 x 100 mm	12 x 69 x 100 mm
Approvals	CE; Marine; OrdLoc/HazLoc; ATEX/IECEx	CE; Marine; OrdLoc/HazLoc; ATEX/IECEx
Data sheet and further information, see:	<a href="http://wago.com/750-1500">wago.com/750-1500</a>	<a href="http://wago.com/750-1504">wago.com/750-1504</a>
<b>Accessories</b>	<b>Item No.</b>	
Interface modules for system wiring and interface cable	See Section 10	

„ Mini-WSB marker card and mounting accessories, see Section "Accessories and Tools"  
 „ Approvals and corresponding ratings, see page 519 or [www.wago.com](http://www.wago.com)

## Digital Output; 24 VDC



Figure: 750-1501

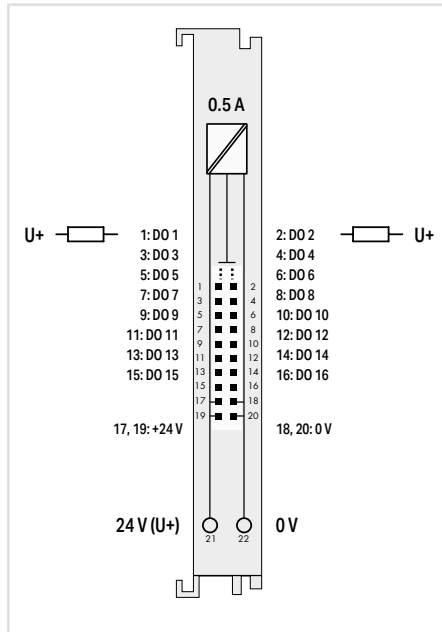
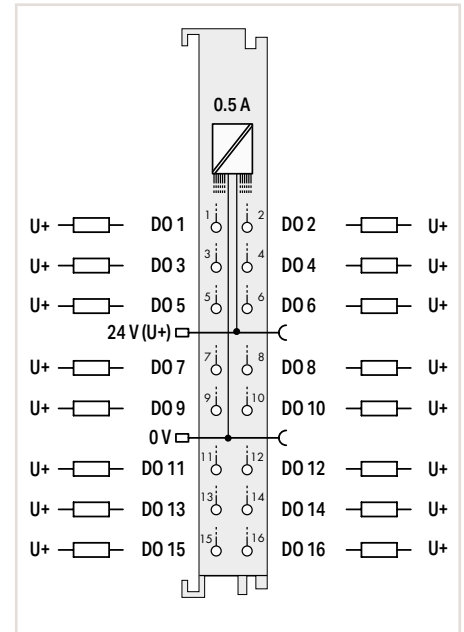


Figure: 750-1505



Item Description	16-Channel Digital Output; 24 VDC; 0.5 A; Low-side switching; Ribbon cable	16-Channel Digital Output; 24 VDC; 0.5 A; Low-side switching
Version	Standard with ribbon cable connector	Standard with 16 connectors
Item No.	750-1501	750-1505
Order Text	16DO; 24 VDC; 0.5A; LSS; Ribbon Cable	16DO; 24 VDC; 0.5A; LSS
<b>Technical Data</b>		
Number of digital outputs	16	16
Signal type	24 VDC	24 VDC
Output characteristic	Low-side switching	Low-side switching
Output current per channel	0.5 A; short-circuit-protected	0.5 A; short-circuit-protected
Load type	Resistive; inductive; lamp load	Resistive; inductive; lamp load
Actuator connection	1-wire	1-wire
Switching frequency (max.)	1 kHz	1 kHz
Supply voltage (field)	24 VDC (-25 ... +30 %); via wiring interface (CAGE CLAMP® connection)	24 VDC (-25 ... +30 %); via power jumper contacts (power supply via blade contact; transmission via spring contact)
Current consumption – system supply (5 V)	40 mA	40 mA
Data width (internal)	16 bits	16 bits
Isolation	500 V (system/field)	500 V (system/field)
Surrounding air temperature (operation)	0 ... +55 °C	0 ... +55 °C
Dimensions W x H x D	12 x 74.1 x 100 mm	12 x 69 x 100 mm
Approvals	CE; Marine; OrdLoc/HazLoc; ATEX/IECEX	CE; Marine; OrdLoc/HazLoc; ATEX/IECEX
Data sheet and further information, see:	<a href="http://wago.com/750-1501">wago.com/750-1501</a>	<a href="http://wago.com/750-1505">wago.com/750-1505</a>
Accessories	Interface modules for system wiring and interface cable	
Item No.	See Section 10	

## Digital Output; 230 VAC



Figure: 753-540

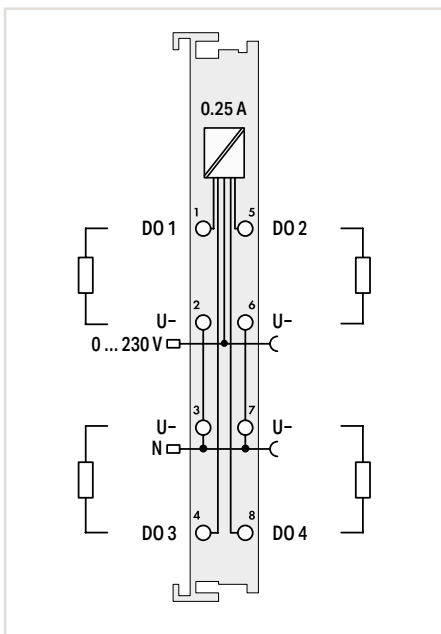
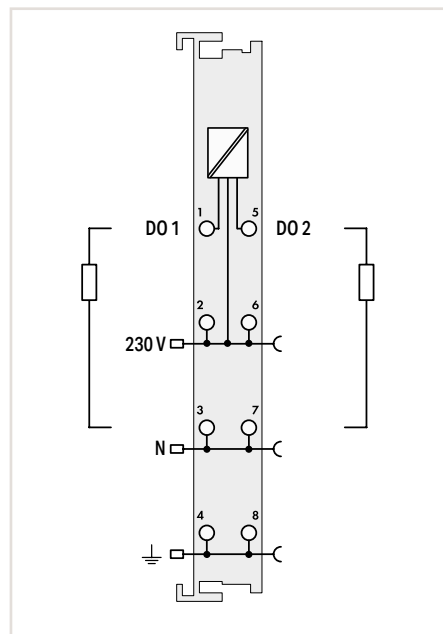


Figure: 750-509



Item Description	4-Channel Digital Output; 230 VAC; 0.25 A; Solid-state	2-Channel Digital Output; 230 VAC; 0.3 A; Solid-state	
Version	Pluggable (delivery without connector)	Standard	Pluggable (delivery without connector)
Item No.	753-540	750-509	753-509
Order Text	4DO; 230 VAC; 0.25A; SSR	2DO; 230 VAC; 0.3A; SSR	2DO; 230 VAC; 0.3A; SSR
<b>Technical Data</b>			
Pluggable connector	•		•
Number of digital outputs	4	2	
Signal type	0 ... 250 VAC	0 ... 230 VAC/DC	
Output circuit design	High-side switching	Solid-state load relays	
Output characteristic	0.25 A; short-circuit-protected	0.3 A	
Output current per channel	Resistive; inductive	Resistive; inductive	
Load type	2-wire	2-wire; 3-wire; 4-wire	
Actuator connection	275 VAC (varistor)	275 VAC (varistor)	
Overvoltage protection	max. 10 A (16 ms)	5 Hz (24 V 0.3 A DF = 50 %); 0.5 Hz (230 V 0.3 A DF = 50 %)	
Short-circuit current	230 VAC; via power jumper contacts (power supply via blade contact; transmission via spring contact)	250 V AC/DC; via power jumper contacts (power supply via blade contact; transmission via spring contact)	
Switching frequency (max.)	18 mA	10 mA	
Supply voltage (field)	4 bits	2 bits	
Current consumption – system supply (5 V)	1500 V (system/field)	1500 V (system/field)	
Data width (internal)	0 ... +55 °C	0 ... +55 °C	
Isolation	12 x 69.8 x 100 mm	12 x 69.8 x 100 mm	
Surrounding air temperature (operation)	CE;  OrdLoc/HazLoc;  ATEX/IECEX	CE;  Marine;  OrdLoc/HazLoc; ATEX/IECEX	
Dimensions W x H x D	<a href="http://wago.com/753-540">wago.com/753-540</a>	<a href="http://wago.com/750-509">wago.com/750-509</a>	<a href="http://wago.com/753-509">wago.com/753-509</a>
Approvals			
Data sheet and further information, see:			
<b>Accessories</b>		<b>Accessories</b>	
Pluggable connector	Item No. 753-110		Item No. 753-110
Coding keys	753-150		753-150

Notice:  
An additional supply module must be added for 0–250 VAC supply!

Notice:  
An additional supply module must be added for 0–230 VAC/DC supply!

„ Mini-WSB marker card and mounting accessories, see Section "Accessories and Tools"

„ Approvals and corresponding ratings, see page 519 or [www.wago.com](http://www.wago.com)



## Relay Output; 125 VAC



Figure: 750-514

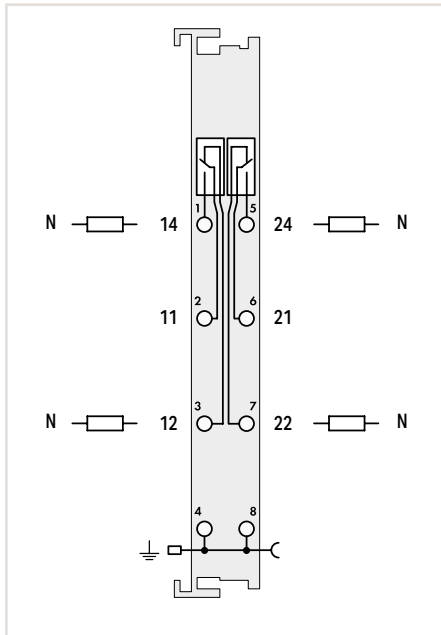


Figure: 753-514

Item Description	
2-Channel Relay Output; 125 VAC; 0.5 A; Potential-free; Relay with 2 changeover contacts	
Version	
Standard	Pluggable (delivery without connector)
750-514	753-514
Order Text	
2RO; 125 VAC; 0.5A; Pot-free; Relay2CO	2RO; 125 VAC; 0.5A; Pot-free; Relay2CO

Technical Data	
Pluggable connector	●
Number of digital outputs	2
Switching voltage (max.)	125 VAC; 30 VDC
Output circuit design	Relay with 2 changeover contacts
Output characteristic	Potential-free
Switching current (max.)	0.5 A for AC; 1 A for DC
Switching current (min.)	0.01 mA / 10 mV (DC)
Actuator connection	1-wire
Switching frequency (max.)	0.33 Hz
Mechanical switching operations (min.)	100 x 10 <sup>6</sup>
Electrical switching operations (min.)	1 x 10 <sup>5</sup>
Supply voltage (field)	Transmission of ground potential via power jumper contact
Current consumption – system supply (5 V)	70 mA
Data width (internal)	2 bits
Isolation	1500 V (system/field)
Surrounding air temperature (operation)	0 ... +55 °C
Dimensions W x H x D	12 x 69.8 x 100 mm
Approvals	CE;  Marine;  OrdLoc
Data sheet and further information, see:	<a href="http://wago.com/750-514">wago.com/750-514</a> <a href="http://wago.com/753-514">wago.com/753-514</a>

Accessories	
Pluggable connector	Item No. 753-110
Coding keys	753-150

## Relay Output; 250 VAC



Figure: 750-517

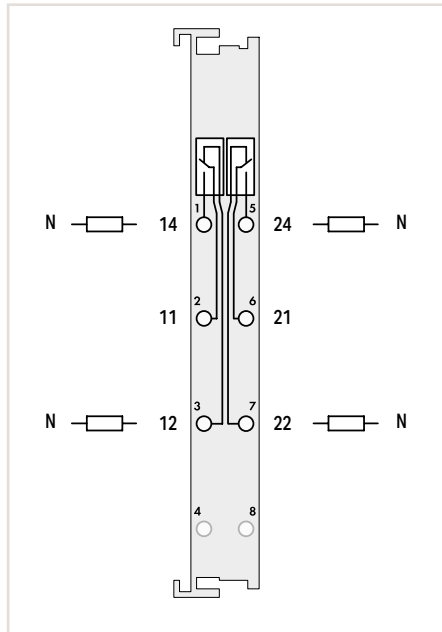
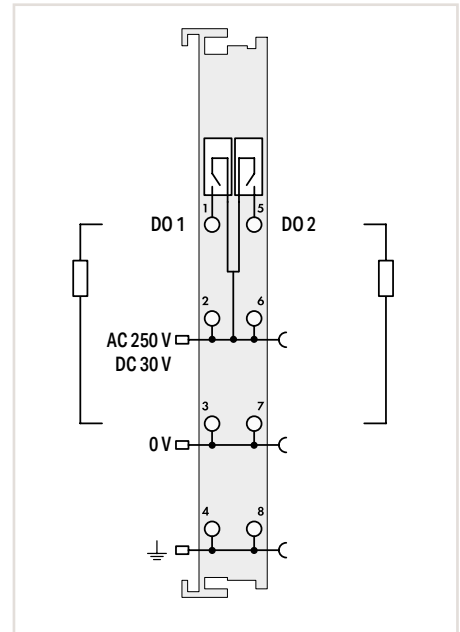


Figure: 750-512



Item Description	2-Channel Relay Output; 250 VAC; 1 A; Potential-free; Relay with 2 changeover contacts		2-Channel Relay Output; 250 VAC; 2 A; Relay with 2 make contacts	
Version	Standard	Pluggable (delivery without connector)	Standard	Pluggable (delivery without connector)
Item No.	750-517	753-517	750-512	753-512
Order Text	2RO; 250 VAC; 1A; Pot-free; Relay2CO		2RO; 250 VAC; 2A; Relay2NO	
<b>Technical Data</b>				
Pluggable connector		•		•
Number of digital outputs	2		2	
Switching voltage (max.)	250 VAC; 300 VDC		250 VAC; 30 VDC	
Output circuit design	Relay with 2 changeover contacts		Relay with 2 make contacts	
Output characteristic	Potential-free		Non-floating	
Switching current (max.)	1 A at 250 VAC / 40 VDC; 0.15 A at 300 VDC		2 A	
Switching current (min.)	100 mA (12 VDC)		10 mA / 5 VDC	
Actuator connection	1-wire		2-wire; 3-wire	
Switching frequency (max.)	0.1 Hz		0.5 Hz	
Mechanical switching operations (min.)	5 x 10 <sup>6</sup>		20 x 10 <sup>6</sup>	
Electrical switching operations (min.)	10 x 10 <sup>5</sup>		3 x 10 <sup>5</sup>	
Supply voltage (field)			250 VAC; via power jumper contacts (power supply via blade contact; transmission via spring contact)	
Current consumption – system supply (5 V)	90 mA		100 mA	
Data width (internal)	2 bits		2 bits	
Isolation	1500 V (system/field)		1500 V (system/field)	
Surrounding air temperature (operation)	0 ... +55 °C		0 ... +55 °C	
Dimensions W x H x D	12 x 69.8 x 100 mm		12 x 69.8 x 100 mm	
Approvals	CE; Marine; OrdLoc/HazLoc; ATEX/IECEX		CE; Marine; OrdLoc/HazLoc; ATEX/IECEX	
Data sheet and further information, see:	wago.com/750-517	wago.com/753-517	wago.com/750-512	wago.com/753-512
Accessories		Item No.		Item No.
Pluggable connector		753-110		753-110
Coding keys		753-150		753-150

Notice:  
An additional supply module must be added for 0–250 VAC/0–30 VDC supply!

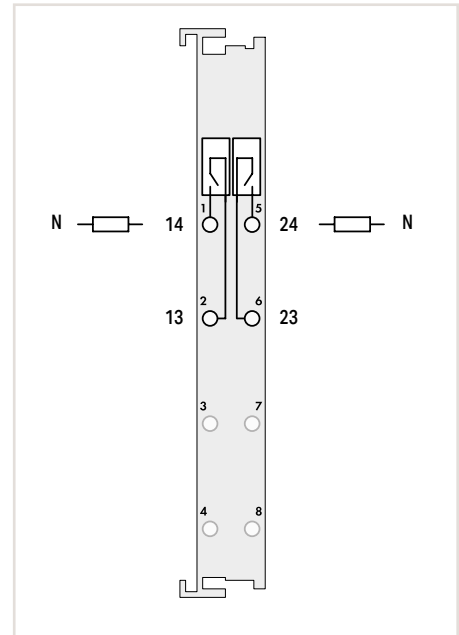
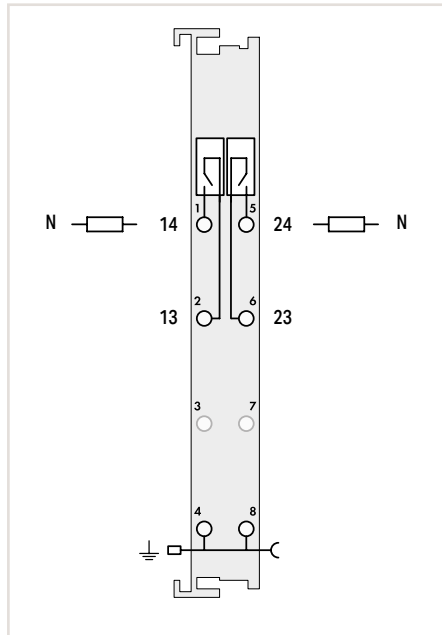
„ Mini-WSB marker card and mounting accessories, see Section "Accessories and Tools"  
„ Approvals and corresponding ratings, see page 519 or www.wago.com

# Relay Output; 250 VAC



Figure: 750-513

Figure: 750-513/000-001

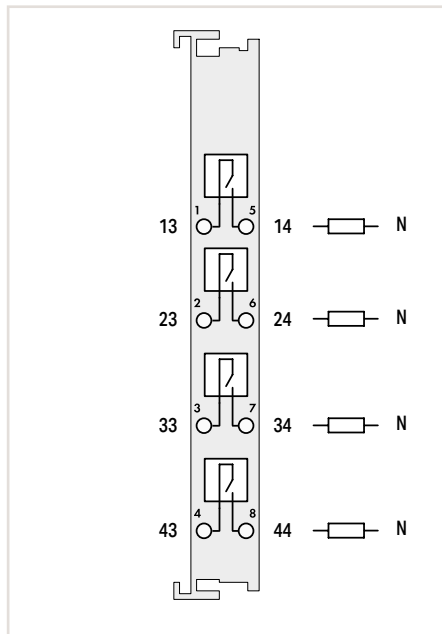


Item Description	2-Channel Relay Output; 250 VAC; 2 A; Potential-free; Relay with 2 make contacts		2-Channel Relay Output; 250 VAC; 2 A; Potential-free; Relay with 2 make contacts	
Version	Standard	Pluggable (delivery without connector)	Without power jumper contacts	Without power jumper contacts; Pluggable (delivery without connector)
Item No.	750-513	753-513	750-513/000-001	753-513/000-001
Order Text	2RO; 250 VAC; 2A; Pot-free; Relay2NO	2RO; 250 VAC; 2A; Pot-free; Relay2NO	2RO; 250 VAC; 2A; Pot-free; NC; Relay2NO	2RO; 250 VAC; 2A; Pot-free; NC; Relay2NO

Technical Data	750-513		750-513/000-001	
Pluggable connector		•		•
Number of digital outputs	2		2	
Switching voltage (max.)	250 VAC; 30 VDC		250 VAC; 30 VDC	
Output circuit design	Relay with 2 make contacts		Relay with 2 make contacts	
Output characteristic	Potential-free		Potential-free	
Switching current (max.)	2 A		2 A	
Switching current (min.)	10 mA / 5 VDC		10 mA / 5 VDC	
Actuator connection	1-wire		1-wire	
Switching frequency (max.)	0.5 Hz		0.5 Hz	
Mechanical switching operations (min.)	20 x 10 <sup>6</sup>		20 x 10 <sup>6</sup>	
Electrical switching operations (min.)	3 x 10 <sup>5</sup>		3 x 10 <sup>5</sup>	
Supply voltage (field)	Transmission of ground potential via power jumper contact			
Current consumption – system supply (5 V)	100 mA		100 mA	
Data width (internal)	2 bits		2 bits	
Isolation	1500 V (system/field)		1500 V (system/field)	
Surrounding air temperature (operation)	0 ... +55 °C		0 ... +55 °C	
Dimensions W x H x D	12 x 69.8 x 100 mm		12 x 69.8 x 100 mm	
Approvals	CE;  Marine;  OrdLoc/HazLoc;  ATEX/IECEX		CE;  Marine;  OrdLoc/HazLoc;  ATEX/IECEX	
Data sheet and further information, see:	<a href="http://wago.com/750-513">wago.com/750-513</a>	<a href="http://wago.com/753-513">wago.com/753-513</a>	<a href="http://wago.com/750-513/000-001">wago.com/750-513/000-001</a>	<a href="http://wago.com/753-513/000-001">wago.com/753-513/000-001</a>

Accessories	Item No.	Item No.
Pluggable connector	753-110	753-110
Coding keys	753-150	753-150

## Relay Output; 250 VAC

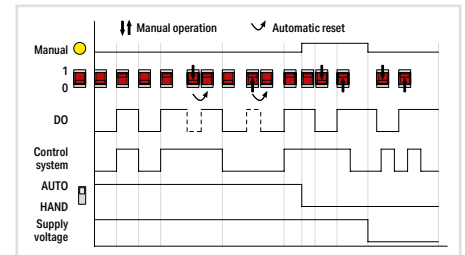
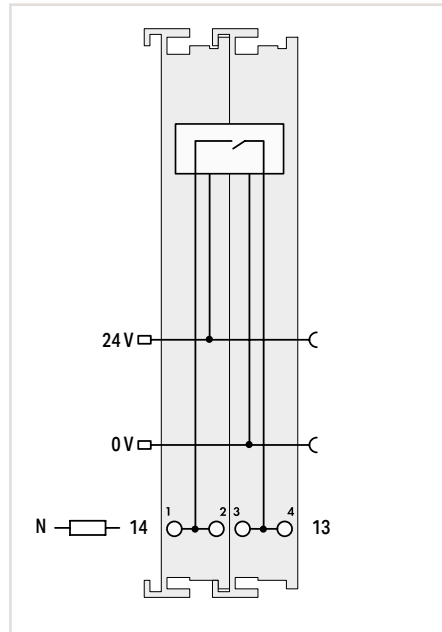


<b>Item Description</b>	<b>4-Channel Relay Output; 250 VAC; 2 A; Potential-free; Relay with 4 make contacts</b>
<b>Version</b>	<b>Standard</b>
<b>Item No.</b>	<b>750-515</b>
<b>Order Text</b>	4RO; 250 VAC; 2A; Pot-free; Relay4NO
<b>Technical Data</b>	
Number of digital outputs	4
Switching voltage (max.)	250 VAC; 30 VDC; 110 VDC at 0.4 A
Output circuit design	Relay with 4 make contacts
Output characteristic	Potential-free
Switching current (max.)	2 A (5 A for single-channel use)
Switching current (min.)	1 mA / 5 VDC
Actuator connection	1-wire
Switching frequency (max.)	0.33 Hz; 0.1 Hz at 5 A
Mechanical switching operations (min.)	20 x 10 <sup>6</sup>
Electrical switching operations (min.)	1 x 10 <sup>5</sup>
Current consumption – system supply (5 V)	95 mA
Data width (internal)	4 bits
Isolation	1500 V (system/field)
Surrounding air temperature (operation)	0 ... +55 °C
Dimensions W x H x D	12 x 67.8 x 100 mm
<b>Approvals</b>	CE;  Marine;  ATEX/IECEX
<b>Data sheet and further information, see:</b>	<a href="http://wago.com/750-515">wago.com/750-515</a>

„ Mini-WSB marker card and mounting accessories, see Section “Accessories and Tools”

„ Approvals and corresponding ratings, see page 519 or [www.wago.com](http://www.wago.com)

## Relay Output; 250 VAC



<b>Item Description</b>	<b>1-Channel Relay Output; 230 VAC; 16 A; Potential-free; Relay with 1 make contacts</b>
<b>Version</b>	<b>Standard</b>
<b>Item No.</b>	<b>750-523</b>
<b>Order Text</b>	1RO; 230 VAC; 16A; Pot-free; Relay1NO
<b>Technical Data</b>	
Number of digital outputs	1
Switching voltage (max.)	440 VAC
Output circuit design	Relay with 1 make contact
Output characteristic	Potential-free
Switching current	16 A
Actuator connection	1-wire
Supply voltage (field)	24 VDC (-25 ... +30 %); via power jumper contacts (power supply via blade contact; transmission via spring contact)
Current consumption – system supply (5 V)	5 mA
Data width (internal)	2-bit input; 2-bit output
Isolation	1500 V (system/field)
Surrounding air temperature (operation)	0 ... +55 °C
Dimensions W x H x D	24 x 67.8 x 100 mm
<b>Approvals</b>	CE; Marine; OrdLoc
<b>Data sheet and further information, see:</b>	<a href="http://wago.com/750-523">wago.com/750-523</a>

This relay output module switches a connected actuator or load.

The 24 VDC supply is derived from the power jumper contacts to trigger the relays.

The switched status of the relay is shown by the manual switch (1/0). The operating mode can be set using a manual/automatic selector switch.

The mode status is indicated by an LED and via status bits in the process image.

Manual: Coil triggering is interrupted. Actuation only via the red manual operating switches.

Auto: The relay is operated via the control system; manual status transitions via the manual switch are reset by the control system after less than 500 ms.

The manual switch can also be used without 24 V supply to switch the output ON.

The relay meets both international standards of IEC and DIN EN 61810 part 1 /VDE 0435 part 201, as well as overload and short circuit requirements of IEC and DIN EN 61036 /61037.

# Analog Input Modules



## Housing design (750 Series)

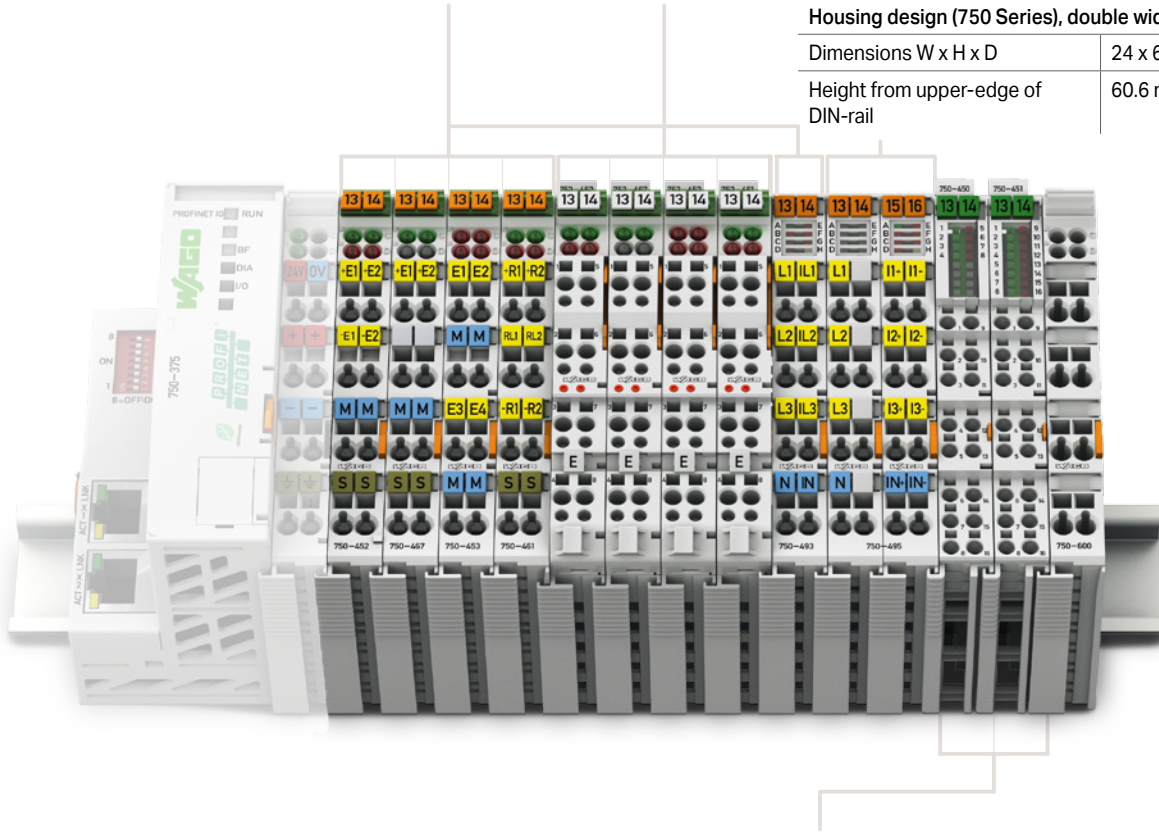
Dimensions W x H x D	Housing with 4 LEDs: 12 x 69.8 x 100 mm Housing with 8 LEDs: 12 x 67.8 x 100 mm
Height from upper-edge of DIN-rail	Housing with 4 LEDs: 62.6 mm Housing with 8 LEDs: 60.6 mm
Connection technology	CAGE CLAMP®
Conductor range	0.08 ... 2.5 mm <sup>2</sup> / 28 ... 14 AWG
Strip length	8 ... 9 mm / 0.33 inch

## Housing design (753 Series)

Dimensions W x H x D	Housing with 4 LEDs: 12 x 69.8 x 100 mm Housing with 8 LEDs: 12 x 69 x 100 mm
Height from upper-edge of DIN-rail	Housing with 4 LEDs: 62.6 mm Housing with 8 LEDs: 61.8 mm
Connection technology	CAGE CLAMP®
Conductor range	0.08 ... 2.5 mm <sup>2</sup> / 28 ... 14 AWG
Strip length	9 ... 10 mm / 0.37 inch

## Housing design (750 Series), double width

Dimensions W x H x D	24 x 67.8 x 100 mm
Height from upper-edge of DIN-rail	60.6 mm



## Housing design (750 Series), with Push-in CAGE CLAMP® connections (up to 16 connection points)

Dimensions W x H x D	12 x 69 x 100 mm
Height from upper-edge of DIN-rail	61.8 mm
Connection technology	Push-in CAGE CLAMP®
Conductor range	Solid: 0.08 ... 1.5 mm <sup>2</sup> / 28 ... 16 AWG Fine-stranded: 0.25–1.5 mm <sup>2</sup> / 22–16 AWG;
Strip length	8 ... 9 mm / 0.33 inch



I/O System – 750 XTR Series



# I/O-System – 750 and 753 Series; Analog Input Modules

## Contents

Function	1-Channel AI	2-Channel AI	4-Channel AI	8-Channel AI	Description	Item Number				Page
						Standard	/S5 or /S7 Customized Data Format	Extended Temperature	Pluggable	
0 ... 20 mA		<input checked="" type="checkbox"/>			2-Channel Analog Input; 0 ... 20 mA; Differential Input	750-452	750-452/000-200		753-452	214
		<input checked="" type="checkbox"/>			2-Channel Analog Input; 0 ... 20 mA; Differential Input	750-480			753-480	214
		<input checked="" type="checkbox"/>			2-Channel Analog Input; 0 ... 20 mA; Single-ended	750-465		750-465/025-000	753-465	215
		<input checked="" type="checkbox"/>			2-Channel Analog Input; 0 ... 20 mA; Single-ended 2-Channel Analog Input; 0 ... 20 mA; Single-ended; 60 Hz	750-470 750-470/005-000				215
		<input checked="" type="checkbox"/>			2-Channel Analog Input; 0 ... 20 mA; Single-ended; 16 bits 2-Channel Analog Input; 0 ... 20 mA; Single-ended; 16 bits; 60 Hz	750-472 750-472/005-000			753-472	216
			<input checked="" type="checkbox"/>		4-Channel Analog Input; 0 ... 20 mA; Single-ended	750-453*			753-453	216
4 ... 20 mA		<input checked="" type="checkbox"/>			2-Channel Analog Input; 4 ... 20 mA; Differential input 2-Channel Analog Input; 4 ... 20 mA; Differential input; Extended measurement range	750-454 750-454/000-003	750-454/000-200	750-454/025-000 750-454/025-003	753-454	217
		<input checked="" type="checkbox"/>			2-Channel Analog Input; 4 ... 20 mA; Differential input	750-492*			753-492	218
		<input checked="" type="checkbox"/>			2-Channel Analog Input; 4 ... 20 mA; Single-ended	750-466	750-466/000-200	750-466/025-000	753-466	219
		<input checked="" type="checkbox"/>			2-Channel Analog Input; 4 ... 20 mA; Single-ended 2-Channel Analog Input; 4 ... 20 mA; Single-ended; 60 Hz	750-473 750-473/005-000				220
		<input checked="" type="checkbox"/>			2-Channel Analog Input; 4 ... 20 mA; Single-ended; 16 bits 2-Channel Analog Input; 4 ... 20 mA; Single-ended; 16 bits; 60 Hz	750-474 750-474/005-000	750-474/000-200		753-474	221
		<input checked="" type="checkbox"/>			2-Channel Analog Input; 4 ... 20 mA HART	750-482 750-482/000-001	750-482/000-300	750-482/025-000	753-482	222
			<input checked="" type="checkbox"/>		4-Channel Analog Input; 4 ... 20 mA; Single-ended	750-455*		750-455/025-000	753-455	223
			<input checked="" type="checkbox"/>		4-Channel Analog Input; 4 ... 20 mA; Single-ended; 4 x 24 V	750-455/020-000				223
0/4 ... 20 mA			<input checked="" type="checkbox"/>	8-Channel Analog Input; 0/4 ... 20 mA; Single-ended	750-496				224	
0 ... 1 A	<input checked="" type="checkbox"/>			2-Channel Analog Input; 0 ... 1 VAC/DC; Differential input	750-475			753-475	225	
0 ... 5 A	<input checked="" type="checkbox"/>			2-Channel Analog Input; 0 ... 5 VAC/DC; Differential input	750-475/020-000				225	
±10 V	<input checked="" type="checkbox"/>			2-Channel Analog Input; ±10 VDC; Differential input	750-456	750-456/000-200		753-456	226	
	<input checked="" type="checkbox"/>			2-Channel Analog Input; ±10 VDC; Differential input 2-Channel Analog Input; ±10 VDC; Differential input; Synchronous	750-479 750-479/000-001			753-479	226	
	<input checked="" type="checkbox"/>			2-Channel Analog Input; ±10 VDC; Single-ended; 16 bits	750-476	750-476/000-200		753-476	227	
	<input checked="" type="checkbox"/>			4-Channel Analog Input; ±10 VDC; Single-ended	750-457*		750-457/025-000	753-457	227	
0 ... 10 V	<input checked="" type="checkbox"/>			2-Channel Analog Input; 0 ... 10 VDC; Single-ended	750-467			753-467	228	
	<input checked="" type="checkbox"/>			2-Channel Analog Input; 0 ... 10 VDC; Single-ended; 16 bits 2-Channel Analog Input; 0 ... 10 VDC; Single-ended; 16 bits; 60 Hz	750-478 750-478/005-000			753-478	228	
	<input checked="" type="checkbox"/>			4-Channel Analog Input; 0 ... 10 VDC; Single-ended	750-468*		750-468/025-000		229	
	<input checked="" type="checkbox"/>			4-Channel Analog Input; 0 ... 10 VDC; Single-ended	750-459			753-459	229	
0 ... 10 V/±10 V			<input checked="" type="checkbox"/>	8-Channel Analog Input; 0 ... 10 VDC/±10 V; Single-ended	750-497				230	
0 ... 10 VAC/DC	<input checked="" type="checkbox"/>			2-Channel Analog Input; 0 ... 10 VAC/DC; Differential input	750-477			753-477	231	
0 ... 30 V	<input checked="" type="checkbox"/>			2-Channel Analog Input; 0 ... 30 VDC; Differential input	750-483*			753-483	231	
Voltage/Current			<input checked="" type="checkbox"/>	4-Channel Analog Input; for voltage/current	750-471				232	
Resistance Sensors	<input checked="" type="checkbox"/>			2-Channel Analog Input; for Pt100/RTD resistance sensors	750-461	750-461/000-200	750-461/025-000	753-461	234	
	<input checked="" type="checkbox"/>			2-Channel Analog Input; for Pt100/RTD resistance sensors; Adjustable	750-461/003-000			753-461/003-000	234	
	<input checked="" type="checkbox"/>			2-Channel Analog Input; for NTC 20k resistance sensors	750-461/020-000				235	
	<input checked="" type="checkbox"/>	<input checked="" type="checkbox"/>		2/4-Channel Analog Input; Resistance measurement; Adjustable	750-464*				236	
	<input checked="" type="checkbox"/>		<input checked="" type="checkbox"/>	4-Channel Analog Input; for NTC resistance sensors; Adjustable	750-464/020-000				236	
	<input checked="" type="checkbox"/>			4-Channel Analog Input; Resistance measurement; Measurement range: -30 °C ... +150 °C	750-463				237	
	<input checked="" type="checkbox"/>			4-Channel Analog Input; Resistance measurement; Adjustable	750-450				237	
	<input checked="" type="checkbox"/>			8-Channel Analog Input; Resistance measurement; Adjustable	750-451		750-451/025-000		237	
Thermocouples	<input checked="" type="checkbox"/>			2-Channel Analog Input; Thermocouple K; Diagnostics	750-469	750-469/000-200		753-469	238	
	<input checked="" type="checkbox"/>			2-Channel Analog Input; Thermocouple K; Diagnostics; Adjustable	750-469/003-000*			753-469/003-000	238	
	<input checked="" type="checkbox"/>			2-Channel Analog Input; Thermocouple J; Diagnostics	750-469/000-006				239	
	<input checked="" type="checkbox"/>			8-Channel Analog Input; Thermocouple; Adjustable	750-458				239	
Analog Specialty Functions	<input checked="" type="checkbox"/>			1-Channel Analog Input; Resistor bridges (strain gauge) 1-Channel Analog Input; Resistor bridges (strain gauge); 125 ms conversion time	750-491 750-491/000-001				240	
	<input checked="" type="checkbox"/>			3-Phase Power Measurement; 480 VAC 1 A 3-Phase Power Measurement; 480 VAC 5 A	750-493 750-493/000-001		750-493/025-000		241	
	<input checked="" type="checkbox"/>			3-Phase Power Measurement; 480 VAC 1 A 3-Phase Power Measurement; 480 VAC 5 A	750-494 750-494/000-001		750-494/025-000 750-494/025-001		242	
	<input checked="" type="checkbox"/>			Power Measurement; 277 VAC/DC; External shunts	750-494/000-005				243	
	<input checked="" type="checkbox"/>			3-Phase Power Measurement; 690 VAC 1 A 3-Phase Power Measurement; 690 VAC 5 A 3-Phase Power Measurement; 690 VAC Rogowski coils	750-495* 750-495/000-001* 750-495/000-002*				244	
Ex i						See Section 5.9				
*This module is also available as a 750 XTR Series variant.						See Section 6				

## Analog Input; 0 ... 20 mA; Differential Input

5.4



Figure: 750-452

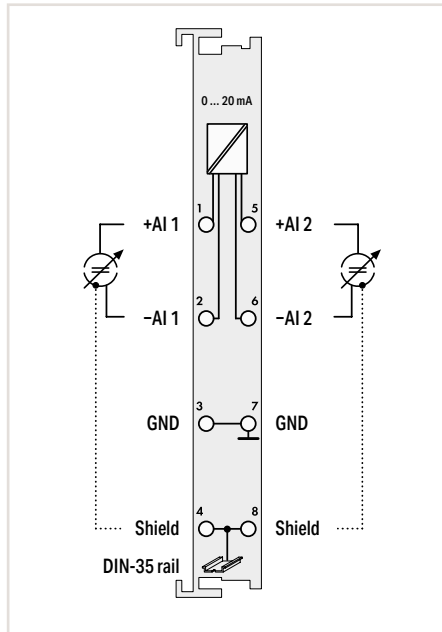
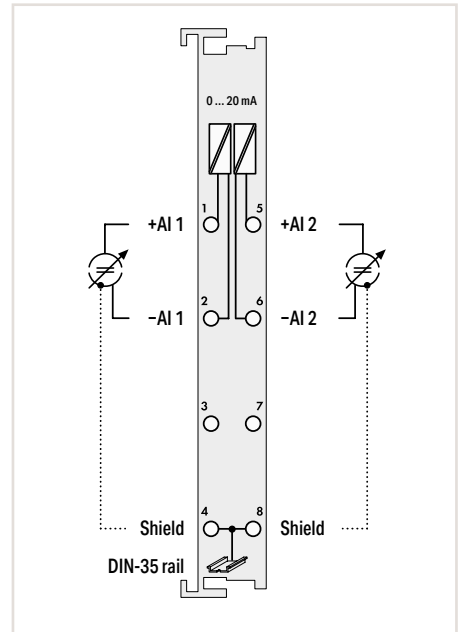


Figure: 750-480



Item Description	2-Channel Analog Input; 0 ... 20 mA; Differential input			2-Channel Analog Input; 0 ... 20 mA; Differential input	
Version	Standard	Data format (S5 control)	Pluggable (delivery without connector)	Standard	Pluggable (delivery without connector)
Item No.	750-452	750-452/000-200	753-452	750-480	753-480
Order Text	2AI; 0-20mA; Diff	2AI; 0-20mA; Diff; S5	2AI; 0-20mA; Diff	2AI; 0-20mA; Diff	2AI; 0-20mA; Diff

Technical Data					
Extended functionality				Time-synchronized measured value acquisition within the module	
Pluggable connector			•		•
Customized data format for S5 control*		•			•
Number of analog inputs	2			2	
Signal type	0 ... 20 mA			0 ... 20 mA	
Signal characteristic	Differential			Differential	
Resolution	12 bits			13 bits	
Conversion time	2 ms			1 ms	
Input resistance	< 220 Ω / 20 mA			< 270 Ω / 20 mA	
Input filter (analog)				5 kHz	
Measuring error (max.) at 25 °C	±0.2 % of the upper-range value			±0.05 % of the upper-range value	
Temperature error (max.)	±0.01 % of the upper-range value			±0.01 % of the upper-range value	
Current consumption – system supply (5 V)	70 mA			80 mA	
Data width	2 x 16-bit data; 2 x 8-bit control/status (optional)			2 x 16-bit data; 2 x 8-bit control/status (optional)	
Isolation	500 V (system/field)			500 V (system/field or channel/channel)	
Surrounding air temperature (operation)	0 ... +55 °C			0 ... +55 °C	
Dimensions W x H x D	12 x 69.8 x 100 mm			12 x 69.8 x 100 mm	
Approvals	CE;  Marine;  OrdLoc/HazLoc;  ATEX/IECEX			CE;  OrdLoc/HazLoc;  ATEX/IECEX	
Data sheet and further information, see:	<a href="http://wago.com/750-452">wago.com/750-452</a>		<a href="http://wago.com/753-452">wago.com/753-452</a>	<a href="http://wago.com/750-480">wago.com/750-480</a>	<a href="http://wago.com/753-480">wago.com/753-480</a>

Accessories	Item No.	Item No.
Pluggable connector	753-110	753-110
Coding keys	753-150	753-150

\*The S5 format allows you to import data with the standard S5 FB 250 function block.

- „ Mini-WSB marker card and mounting accessories, see Section "Accessories and Tools"
- „ Approvals and corresponding ratings, see page 520 or [www.wago.com](http://www.wago.com)

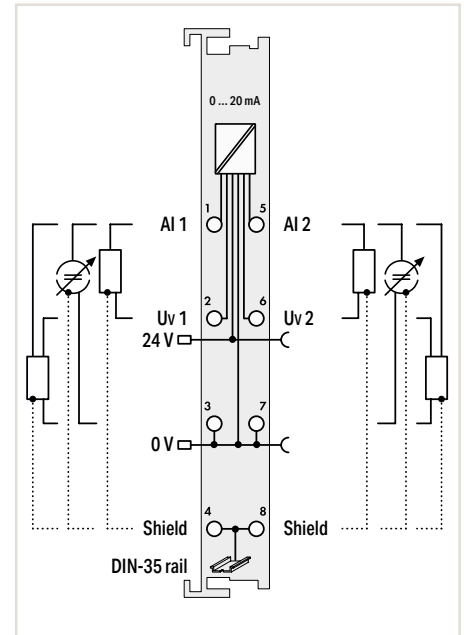
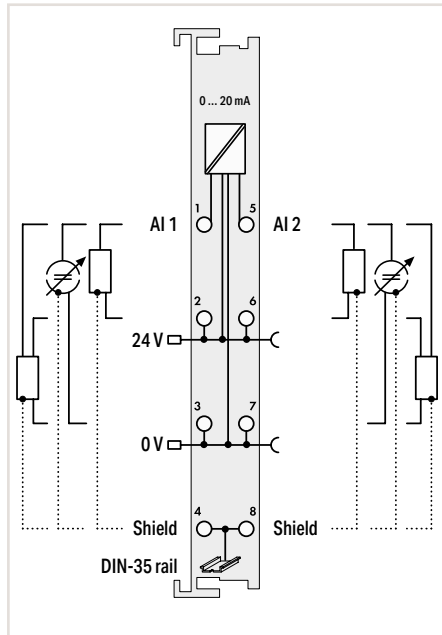


# Analog Input; 0 ... 20 mA; Single-Ended



Figure: 750-465

Figure: 750-470



Item Description	2-Channel Analog Input; 0 ... 20 mA; Single-ended			2-Channel Analog Input; 0 ... 20 mA; Single-ended; Short-circuit-protected sensor supply	
Version	Standard	Extended temperature	Pluggable (delivery without connector)	Standard	60 Hz
Item No.	750-465	750-465/025-000	753-465	750-470	750-470/005-000
Order Text	2AI; 0-20mA; SE	2AI; 0-20mA; SE; T	2AI; 0-20mA; SE	2AI; 0-20mA; SE	2AI; 0-20mA; SE; 60Hz
<b>Technical Data</b>				Short-circuit-protected sensor supply	
Extended functionality					
Pluggable connector				●	
Number of analog inputs	2			2	
Signal type	0 ... 20 mA			0 ... 20 mA	
Signal characteristic	Single-ended			Single-ended	
Resolution	12 bits			12 bits	
Conversion time	2 ms			80 ms	
Input resistance	< 220 Ω / 20 mA			< 160 Ω / 20 mA	
Input filter (analog)				50 Hz	60 Hz
Measuring error (max.) at 25 °C	±0.2 % of the upper-range value			±0.1 % of the upper-range value	
Temperature error (max.)	±0.01 % of the upper-range value			±0.01 % of the upper-range value	
Supply voltage (field)	24 VDC (-25 ... +30 %); via power jumper contacts (power supply via blade contact; transmission via spring contact)			24 VDC (-25 ... +30 %); via power jumper contacts (power supply via blade contact; transmission via spring contact)	
Current consumption – system supply (5 V)	75 mA			100 mA	
Data width	2 x 16-bit data; 2 x 8-bit control/status (optional)			2 x 16-bit data; 2 x 8-bit control/status (optional)	
Isolation	500 V (system/field)			500 V (system/field)	
Surrounding air temperature (operation)	0 ... +55 °C	-20 ... +60 °C	0 ... +55 °C	0 ... +55 °C	
Dimensions W x H x D	12 x 69.8 x 100 mm			12 x 69.8 x 100 mm	
Approvals	CE;  OrdLoc/HazLoc;  ATEX/IECEX			CE;  Marine;  OrdLoc/HazLoc;  ATEX/IECEX	
Data sheet and further information, see:	<a href="http://wago.com/750-465">wago.com/750-465</a>		<a href="http://wago.com/753-465">wago.com/753-465</a>	<a href="http://wago.com/750-470">wago.com/750-470</a>	
<b>Accessories</b>					
Pluggable connector				Item No. 753-110	
Coding keys				753-150	

## Analog Input; 0 ... 20 mA; Single-Ended

5.4



Figure: 750-472

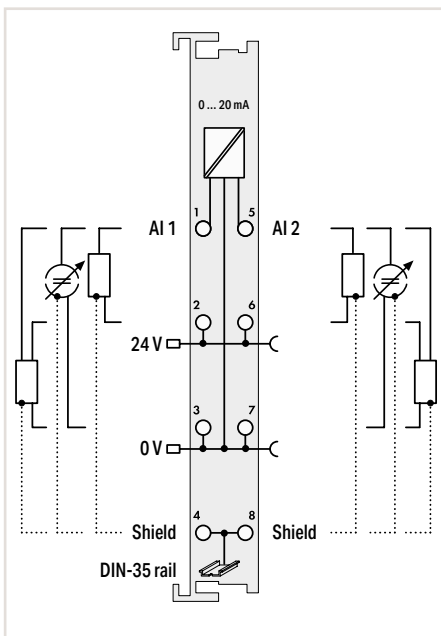
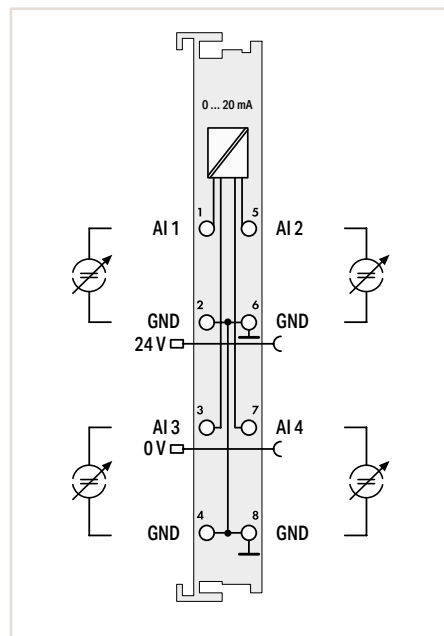


Figure: 750-453



Item Description	2-Channel Analog Input; 0 ... 20 mA; Single-ended; 16 bits			4-Channel Analog Input; 0 ... 20 mA; Single-ended	
Version	Standard	60 Hz	Pluggable (delivery without connector)	Standard	Pluggable (delivery without connector)
Item No.	750-472	750-472/005-000	753-472	750-453	753-453
Order Text	2AI; 0-20mA; SE; 16bits	2AI; 0-20mA; SE; 16bits; 60Hz	2AI; 0-20mA; SE; 16bits	4AI; 0-20mA; SE	4AI; 0-20mA; SE

Technical Data	2-Channel Analog Input; 0 ... 20 mA; Single-ended; 16 bits			4-Channel Analog Input; 0 ... 20 mA; Single-ended	
Extended functionality	Overload protection				
Pluggable connector			•		•
Number of analog inputs	2			4	
Signal type	0 ... 20 mA			0 ... 20 mA	
Signal characteristic	Single-ended			Single-ended	
Resolution	15 bits			12 bits	
Conversion time	80 ms			10 ms	
Input resistance	220 Ω / 20 mA			< 100 Ω / 20 mA	
Input filter (analog)	50 Hz	60 Hz	50 Hz		
Measuring error (max.) at 25 °C	±0.1 % of the upper-range value			±0.1 % of the upper-range value	
Temperature error (max.)	±0.01 % of the upper-range value			±0.01 % of the upper-range value	
Supply voltage (field)	24 VDC (-25 ... +30 %); via power jumper contacts (power supply via blade contact; transmission via spring contact)			24 VDC (-25 ... +30 %); via power jumper contacts (power supply via blade contact; transmission via spring contact)	
Current consumption – system supply (5 V)	75 mA			65 mA	
Data width	2 x 16-bit data; 2 x 8-bit control/status (optional)			4 x 16-bit data; 4 x 8-bit control/status (optional)	
Isolation	500 V (system/field)			500 V (system/field)	
Surrounding air temperature (operation)	0 ... +55 °C			0 ... +55 °C	
Dimensions W x H x D	12 x 69.8 x 100 mm			12 x 69.8 x 100 mm	
Approvals	CE; Marine; OrdLoc/HazLoc; ATEX/IECEX			CE; Marine; OrdLoc/HazLoc; ATEX/IECEX	
Data sheet and further information, see:	<a href="http://wago.com/750-472">wago.com/750-472</a>		<a href="http://wago.com/753-472">wago.com/753-472</a>	<a href="http://wago.com/750-453">wago.com/750-453</a>	<a href="http://wago.com/753-453">wago.com/753-453</a>

Accessories	Item No.
Pluggable connector	753-110
Coding keys	753-150

„ Mini-WSB marker card and mounting accessories, see Section "Accessories and Tools"  
 „ Approvals and corresponding ratings, see page 520 or www.wago.com

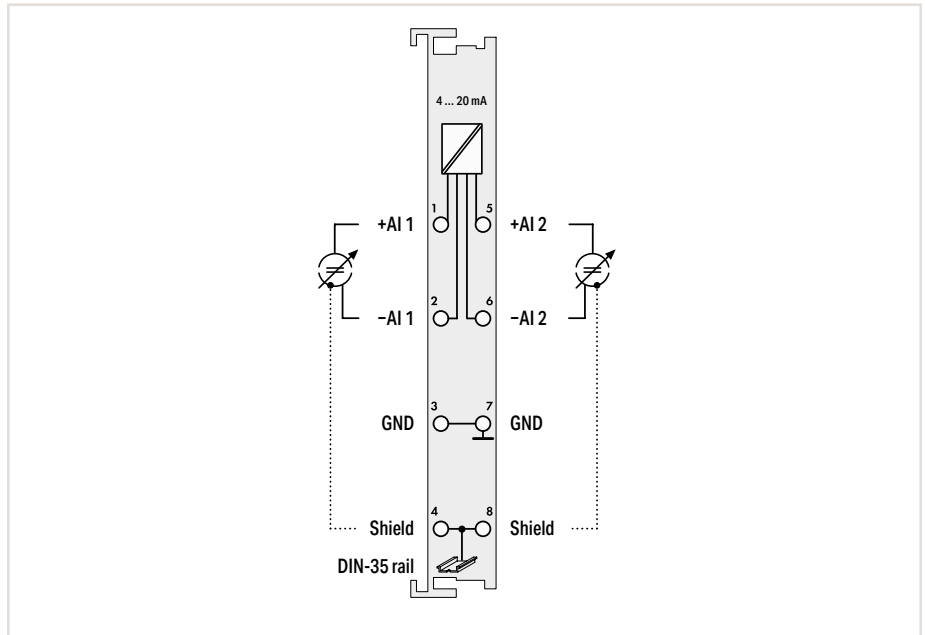
## Analog Input; 4 ... 20 mA; Differential Input



Figure: 750-454



Figure: 753-454



Item Description		2-Channel Analog Input; 4 ... 20 mA; Differential input					
Version		Standard	Extended temperature	Pluggable (delivery with-out connector)	Data format (S5 control)	Extended measurement range	Extended temperature; Extended measurement range
Item No.	750-454	750-454/025-000	753-454	750-454/000-200	750-454/000-003	750-454/025-003	
Order Text	2AI; 4-20mA; Diff	2AI; 4-20mA; Diff; T	2AI; 4-20mA; Diff	2AI; 4-20mA; Diff; S5	2AI; 4-20mA; Diff; EM	2AI; 4-20mA; Diff; T; EM	

Technical Data	
Pluggable connector	•
Customized data format for S5 control*	•
Number of analog inputs	2
Signal type	4 ... 20 mA      3.8 ... 20.5 mA
Signal characteristic	Differential
Resolution	12 bits
Conversion time	2 ms
Input resistance	< 220 Ω / 20 mA
Measuring error (max.) at 25 °C	±0.2 % of the upper-range value
Temperature error (max.)	±0.01 % of the upper-range value
Current consumption – system supply (5 V)	70 mA
Data width	2 x 16-bit data; 2 x 8-bit control/status (optional)
Isolation	500 V (system/field)
Surrounding air temperature (operation)	0 ... +55 °C    -20 ... +60 °C      0 ... +55 °C      -20 ... +60 °C
Dimensions W x H x D	12 x 69.8 x 100 mm
Approvals	CE; Marine; OrdLoc/HazLoc; ATEX/IECEx
Data sheet and further information, see:	wago.com/750-454      wago.com/753-454      wago.com/750-454

Accessories	Item No.
Pluggable connector	753-110
Coding keys	753-150

\*The S5 format allows you to import data with the standard S5 FB 250 function block.

## Analog Input; 4 ... 20 mA; Differential Input

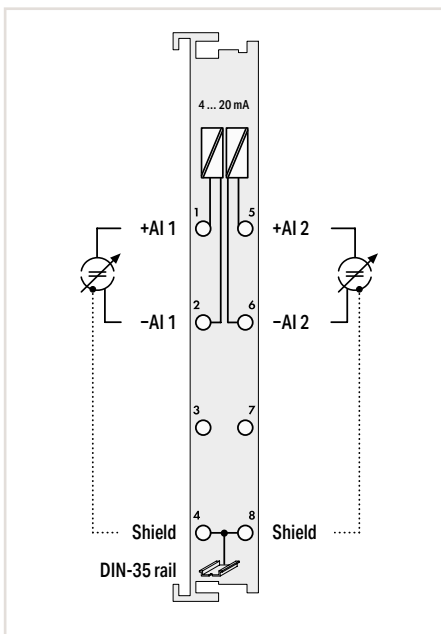
5.4



Figure: 750-492



Figure: 753-492



Item Description		2-Channel Analog Input; 4 ... 20 mA; Differential input	
Version		Standard	Pluggable (delivery without connector)
Item No.	750-492	750-492	753-492
Order Text	2AI; 4-20mA; Diff	2AI; 4-20mA; Diff	2AI; 4-20mA; Diff
<b>Technical Data</b>			
Extended functionality	Time-synchronized measured value acquisition within the module		
Pluggable connector			•
Number of analog inputs	2		
Signal type	4 ... 20 mA		
Signal characteristic	Differential		
Resolution	13 bits		
Conversion time	1 ms		
Input resistance	< 270 Ω / 20 mA		
Measuring error (max.) at 25 °C	±0.05 % of the upper-range value		
Temperature error	±0.01 % of the upper-range value		
Current consumption – system supply (5 V)	80 mA		
Data width	2 x 16-bit data; 2 x 8-bit control/status (optional)		
Isolation	500 V (system/field or channel/channel)		
Surrounding air temperature (operation)	0 ... +55 °C		
Dimensions W x H x D	12 x 69.8 x 100 mm		
Approvals	CE;  OrdLoc/HazLoc;  ATEX/IECEx		
Data sheet and further information, see:	<a href="http://wago.com/750-492">wago.com/750-492</a>	<a href="http://wago.com/753-492">wago.com/753-492</a>	
<b>Accessories</b>		<b>Item No.</b>	
Pluggable connector		753-110	
Coding keys		753-150	

„ Mini-WSB marker card and mounting accessories, see Section “Accessories and Tools”

„ Approvals and corresponding ratings, see page 520 or [www.wago.com](http://www.wago.com)

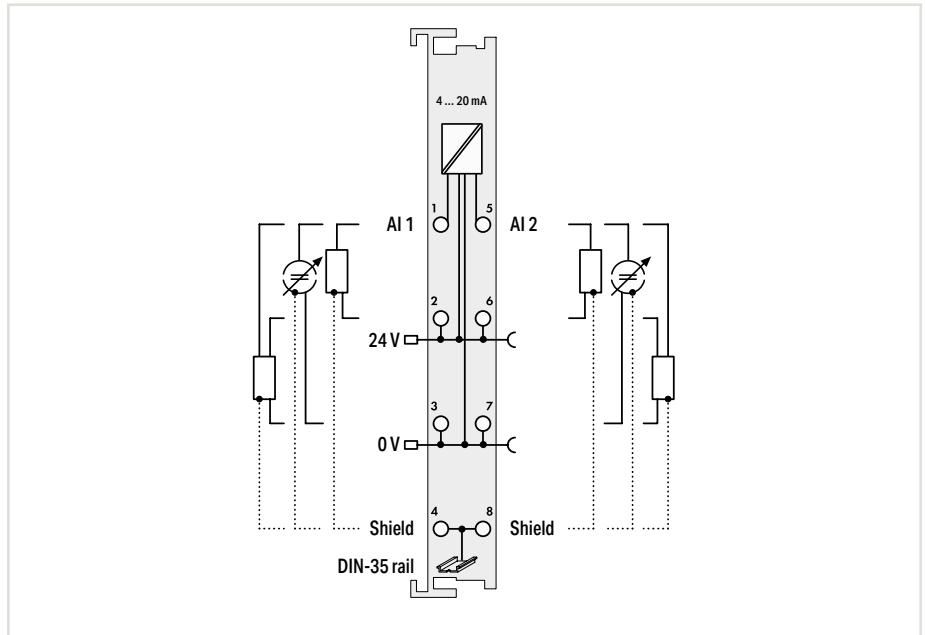
## Analog Input; 4 ... 20 mA; Single-Ended



Figure: 750-466



Figure: 753-466



Item Description						
Version						
Item No.	Order Text	Standard	Extended temperature	Pluggable (delivery without connector)	Data format (S5 control)	Extended measurement range
750-466	2AI; 4-20mA; SE	750-466	750-466/025-000	753-466	750-466/000-200	750-466/000-003
			2AI; 4-20mA; SE; T	2AI; 4-20mA; SE	2AI; 4-20mA; SE; S5	2AI; 4-20mA; SE; EM

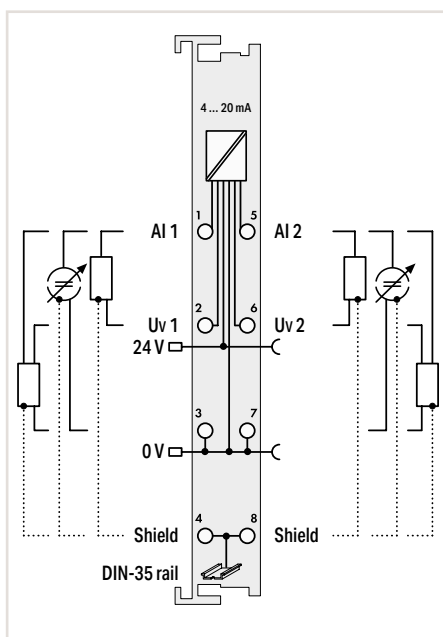
Technical Data				
Pluggable connector				•
Customized data format for S5 control*				•
Number of analog inputs	2			
Signal type	4 ... 20 mA			3.8 ... 20.5 mA
Signal characteristic	Single-ended			
Resolution	12 bits			
Conversion time	2 ms			
Input resistance	< 220 Ω / 20 mA			
Measuring error (max.) at 25 °C	±0.2 % of the upper-range value			
Temperature error (max.)	±0.01 % of the upper-range value			
Supply voltage (field)	24 VDC (-25 ... +30 %); via power jumper contacts (power supply via blade contact; transmission via spring contact)			
Current consumption – system supply (5 V)	75 mA			
Data width	2 x 16-bit data; 2 x 8-bit control/status (optional)			
Isolation	500 V (system/field)			
Surrounding air temperature (operation)	0 ... +55 °C	-20 ... +60 °C	0 ... +55 °C	
Dimensions W x H x D	12 x 69.8 x 100 mm			
Approvals	CE; OrdLoc/HazLoc; ATEX/IECEX			
Data sheet and further information, see:	<a href="http://wago.com/750-466">wago.com/750-466</a>	<a href="http://wago.com/753-466">wago.com/753-466</a>	<a href="http://wago.com/750-466">wago.com/750-466</a>	

Accessories		Item No.
Pluggable connector		753-110
Coding keys		753-150

\*The S5 format allows you to import data with the standard S5 FB 250 function block.

## Analog Input; 4 ... 20 mA; Single-Ended

5.4



### Item Description

Version

Item No.

Order Text

### 2-Channel Analog Input; 4 ... 20 mA; Single-ended

Standard

750-473

2AI; 4-20mA; SE

60 Hz

750-473/005-000

2AI; 4-20mA; SE; 60Hz

### Technical Data

Extended functionality

Number of analog inputs

Signal type

Signal characteristic

Resolution

Conversion time

Input resistance

Input filter (analog)

Measuring error (max.) at 25 °C

Temperature error (max.)

Supply voltage (field)

Current consumption – system supply (5 V)

Data width

Isolation

Surrounding air temperature (operation)

Dimensions W x H x D

### Approvals

Data sheet and further information, see:

Short-circuit-protected sensor supply

2

4 ... 20 mA

Single-ended

12 bits

80 ms

&lt; 160 Ω / 20 mA

50 Hz

60 Hz

±0.1 % of the upper-range value

±0.01 % of the upper-range value

24 VDC (-25 ... +30 %); via power jumper contacts (power supply via blade contact; transmission via spring contact)

100 mA

2 x 16-bit data; 2 x 8-bit control/status (optional)

500 V (system/field)

0 ... +55 °C

12 x 69.8 x 100 mm

CE; Marine; OrdLoc/HazLoc;

ATEX/IECEX

[wago.com/750-473](http://wago.com/750-473)

„ Mini-WSB marker card and mounting accessories, see Section “Accessories and Tools”

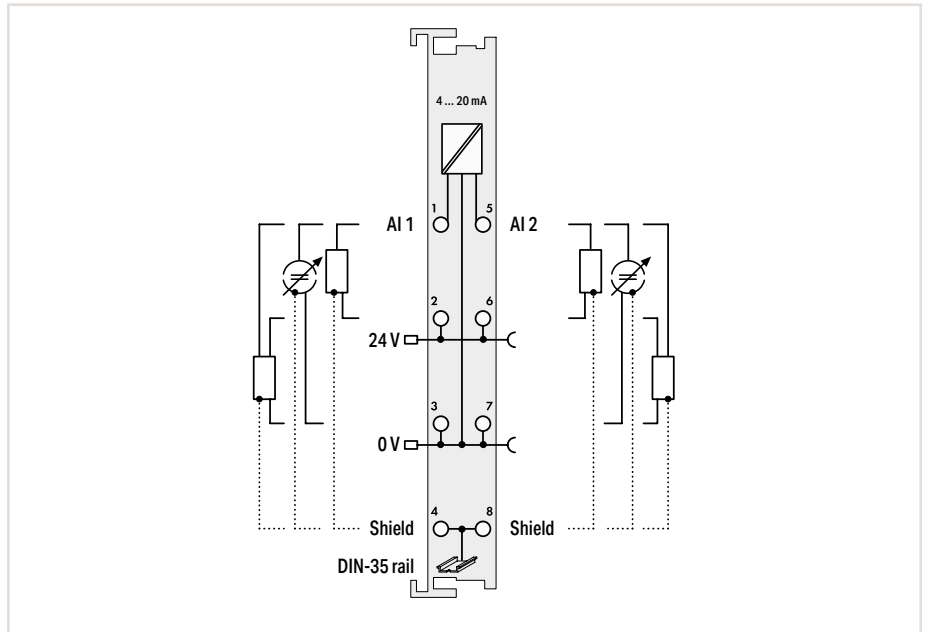
„ Approvals and corresponding ratings, see page 520 or [www.wago.com](http://www.wago.com)

## Analog Input; 4 ... 20 mA; Single-Ended



Figure: 750-474

Figure: 753-474



Item Description		2-Channel Analog Input; 4 ... 20 mA; Single-ended; 16 bits			
Version		Standard	60 Hz	Pluggable (delivery without connector)	Data format (S5 control)
Item No.		750-474	750-474/005-000	753-474	750-474/000-200
Order Text		2AI; 4-20mA; SE; 16bits	2AI; 4-20mA; SE; 16bits; 60Hz	2AI; 4-20mA; SE; 16bits	2AI; 4-20mA; SE; 16bits; S5

Technical Data	
Extended functionality	Overload protection
Pluggable connector	•
Customized data format for S5* controller	•
Number of analog inputs	2
Signal type	4 ... 20 mA
Signal characteristic	Single-ended
Resolution	15 bits
Conversion time	80 ms
Input resistance	220 Ω / 20 mA
Input filter (analog)	50 Hz      60 Hz      50 Hz
Measuring error (max.) at 25 °C	±0.1 % of the upper-range value
Temperature error (max.)	±0.01 % of the upper-range value
Supply voltage (field)	24 VDC (-25 ... +30 %); via power jumper contacts (power supply via blade contact; transmission via spring contact)
Current consumption – system supply (5 V)	75 mA
Data width	2 x 16-bit data; 2 x 8-bit control/status (optional)
Isolation	500 V (system/field)
Surrounding air temperature (operation)	0 ... +55 °C
Dimensions W x H x D	12 x 69.8 x 100 mm
Approvals	CE; Marine; OrdLoc/HazLoc; ATEX/IECEx
Data sheet and further information, see:	<a href="http://wago.com/750-474">wago.com/750-474</a> <a href="http://wago.com/753-474">wago.com/753-474</a> <a href="http://wago.com/750-474/000-200">wago.com/750-474/000-200</a>

Accessories	Item No.
Pluggable connector	753-110
Coding keys	753-150

\*The S5 format allows you to import data with the standard S5 FB 250 function block.

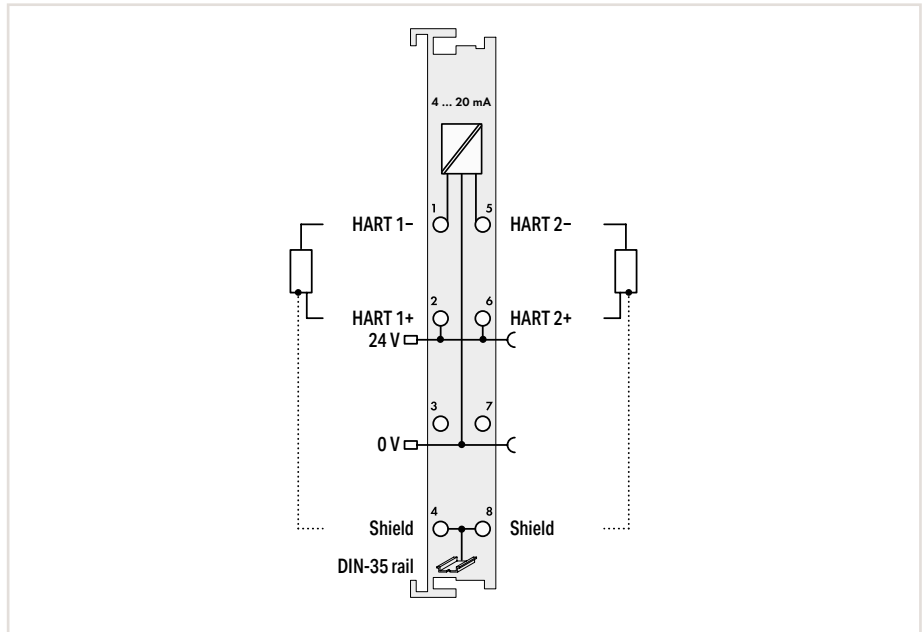
## Analog Input; 4 ... 20 mA HART

5.4



Figure: 750-482

Figure: 753-482



Item Description		2-Channel Analog Input; 4 ... 20 mA HART			
Version		Standard	Extended temperature	Pluggable (delivery without connector)	Data format (S7 controller)
Item No.		750-482	750-482/025-000	753-482	750-482/000-300
Order Text		2AI; 4-20mA HART	2AI; 4-20mA HART; T	2AI; 4-20mA HART	2AI; 4-20mA HART; S7
Technical Data					
Extended functionality	Overload protection				
Pluggable connector				•	
Customized data format for S7 control					•
Number of analog inputs	2				
Signal type	4 ... 20 mA				
Signal characteristic	Single-ended				
Resolution	12 bits				
Conversion time	10 ms				
Measuring error (max.) at 25 °C	±0.1 % of the upper-range value				
Temperature error (max.)	±0.01 % of the upper-range value				
Supply voltage (field)	24 VDC (-25 ... +30 %); via power jumper contacts (power supply via blade contact; transmission via spring contact)				
Current consumption – system supply (5 V)	65 mA				
Data width	2 x 2-byte data; 2 x 2-byte data + 2n x 4-byte data (n = number of dynamic variables); 2 x 2-byte data + 6-byte mailbox				
Configurable functions	4 HART dynamic variables (PV, SV, TV, QV)				
Isolation	500 V (system/field)				
Surrounding air temperature (operation)	0 ... +55 °C	-20 ... +60 °C			0 ... +55 °C
Dimensions W x H x D	12 x 69.8 x 100 mm				
Approvals	CE;  OrdLoc/HazLoc;  ATEX/IECEx				
Data sheet and further information, see:	<a href="http://wago.com/750-482">wago.com/750-482</a>		<a href="http://wago.com/753-482">wago.com/753-482</a>		<a href="http://wago.com/750-482/000-300">wago.com/750-482/000-300</a>
Accessories		Item No.			
Pluggable connector		753-110			
Coding keys		753-150			

HART devices per channel:  
1 device (SingleDrop, no MultiDrop)

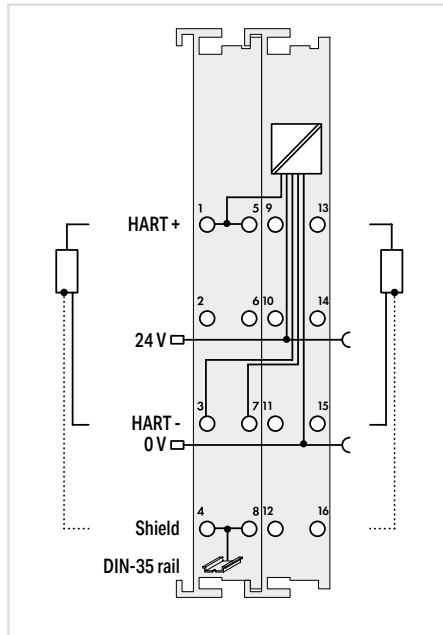
For select fieldbus couplers, FDT/DTM device drivers are available that can be used to integrate the I/O module into a higher-level control system.

„ Mini-WSB marker card and mounting accessories, see Section "Accessories and Tools"

„ Approvals and corresponding ratings, see page 520 or [www.wago.com](http://www.wago.com)



## Analog Input; 4 ... 20 mA HART



<b>Item Description</b>	<b>2-Channel Analog Input; 4 ... 20 mA HART</b>
<b>Version</b>	<b>NAMUR NE43</b>
<b>Item No.</b>	<b>750-482/000-001</b>
<b>Order Text</b>	<b>2AI; 4-20mA HART; NE43</b>
<b>Technical Data</b>	
Extended functionality	Overload protection
Number of analog inputs	2
Signal type	3.6 ... 21 mA
Signal characteristic	Single-ended
Resolution	12 bits
Conversion time	10 ... 640 ms (programmable)
Measuring error (max.) at 25 °C	±0.2 % of the upper-range value
Temperature error (max.)	±0.01 % of the upper-range value
Supply voltage (field)	24 VDC (-25 ... +30 %); via power jumper contacts (power supply via blade contact; transmission via spring contact)
Current consumption – system supply (5 V)	25 mA
Data width	2 x 2-byte data; 2 x 2-byte data + 2n x 4-byte data (n = number of dynamic variables); 2 x 2-byte data + 6-byte mailbox
Configurable functions	4 HART dynamic variables (PV, SV, TV, QV)
Isolation	500 V (system/field)
Surrounding air temperature (operation)	0 ... +55 °C
Dimensions W x H x D	24 x 67.8 x 100 mm
<b>Approvals</b>	<b>CE; OrdLoc/HazLoc; ATEX/IECEx</b>
<b>Data sheet and further information, see:</b>	<b><a href="http://wago.com/750-482/000-001">wago.com/750-482/000-001</a></b>

HART devices per channel:  
1 device (SingleDrop, no MultiDrop)

For select fieldbus couplers, FDT/DTM device drivers are available that can be used to integrate the I/O module into a higher-level control system.

## Analog Input; 4 ... 20 mA; Single-Ended

5.4



Figure: 750-455

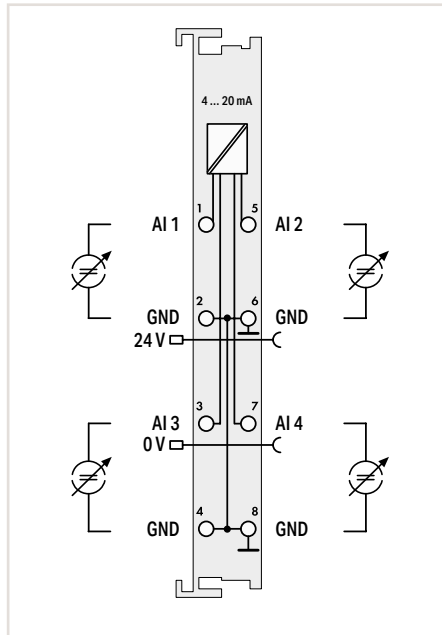
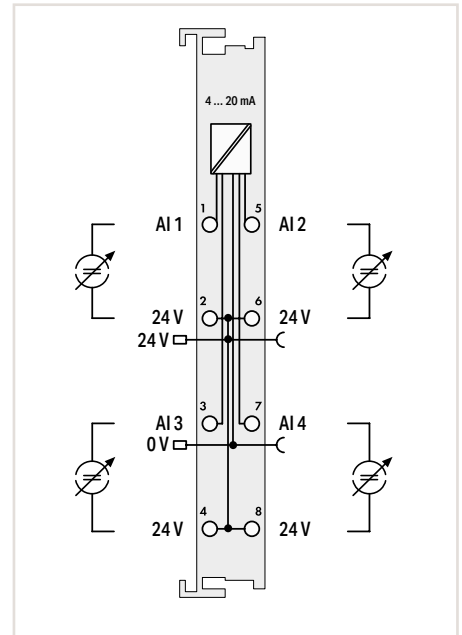


Figure: 753-455

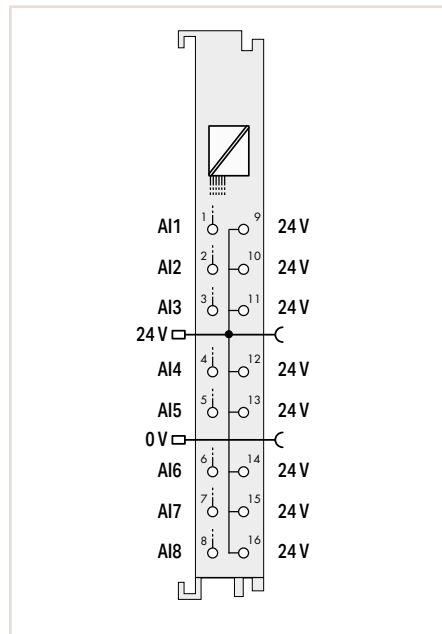


Item Description	4-Channel Analog Input; 4 ... 20 mA; Single-ended; 4 x GND			4-Channel Analog Input; 4 ... 20 mA; Single-ended; 4 x 24 V		
Version	Standard	Extended temperature	Pluggable (delivery without connector)	4 x 24 V		
Item No.	750-455	750-455/025-000	753-455	750-455/020-000		
Order Text	4AI; 4-20mA; SE	4AI; 4-20mA; SE; T	4AI; 4-20mA; SE	4AI; 4-20mA; SE; 4x24V		
<b>Technical Data</b>						
Pluggable connector			●			
Number of analog inputs	4			4		
Signal type	4 ... 20 mA			4 ... 20 mA		
Signal characteristic	Single-ended			Single-ended		
Resolution	12 bits			12 bits		
Conversion time	10 ms			10 ms		
Input resistance	< 100 Ω / 20 mA			< 100 Ω / 20 mA		
Measuring error (max.) at 25 °C	±0.1 % of the upper-range value			±0.1 % of the upper-range value		
Temperature error (max.)	±0.01 % of the upper-range value			±0.01 % of the upper-range value		
Supply voltage (field)	24 VDC (-25 ... +30 %); via power jumper contacts (power supply via blade contact; transmission via spring contact)			24 VDC (-25 ... +30 %); via power jumper contacts (power supply via blade contact; transmission via spring contact)		
Current consumption – system supply (5 V)	65 mA			65 mA		
Data width	4 x 16-bit data; 4 x 8-bit control/status (optional)			4 x 16-bit data; 4 x 8-bit control/status (optional)		
Isolation	500 V (system/field)			500 V (system/field)		
Surrounding air temperature (operation)	0 ... +55 °C			0 ... +55 °C		
Dimensions W x H x D	12 x 69.8 x 100 mm			12 x 69.8 x 100 mm		
Approvals	CE; Marine; OrdLoc/HazLoc; ATEX/IECEX			CE; Marine; OrdLoc/HazLoc; ATEX/IECEX		
Data sheet and further information, see:	wago.com/750-455		wago.com/753-455	wago.com/750-455/020-000		
<b>Accessories</b>			<b>Item No.</b>			
Pluggable connector			753-110			
Coding keys			753-150			

„ Mini-WSB marker card and mounting accessories, see Section "Accessories and Tools"

„ Approvals and corresponding ratings, see page 520 or www.wago.com

## Analog Input; Configurable 0/4 ... 20 mA; Single-Ended



<b>Item Description</b>	<b>8-Channel Analog Input; 0/4 ... 20 mA; Single-ended</b>
<b>Version</b>	<b>Standard</b>
<b>Item No.</b>	<b>750-496</b>
<b>Order Text</b>	8AI; 0/4-20mA; SE
<b>Technical Data</b>	
Number of analog inputs	8
Signal type	Configurable: 0 ... 20 mA; 4 ... 20 mA; 3.6 ... 21 mA
Resolution	12 bits
Conversion time	10 ms
Input resistance	< 220 Ω
Input voltage (max.)	31.2 VDC
Measuring error (max.) at 25 °C	±0.1 % of the upper-range value
Temperature error (max.)	±0.01 % of the upper-range value
Supply voltage (field)	24 VDC (-25 ... +30 %); via power jumper contacts (power supply via blade contact; transmission via spring contact)
Current consumption – system supply (5 V)	69 mA
Data width	8 x 16-bit data; 8 x 8-bit control/status (optional)
Isolation	500 V (system/field)
Surrounding air temperature (operation)	0 ... +55 °C
Dimensions W x H x D	12 x 69 x 100 mm
<b>Approvals</b>	CE; Marine; OrdLoc/HazLoc; ATEX/IECEx
<b>Data sheet and further information, see:</b>	<a href="http://wago.com/750-496">wago.com/750-496</a>

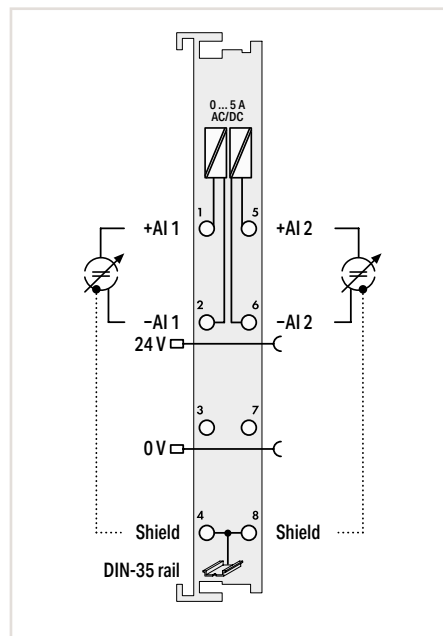
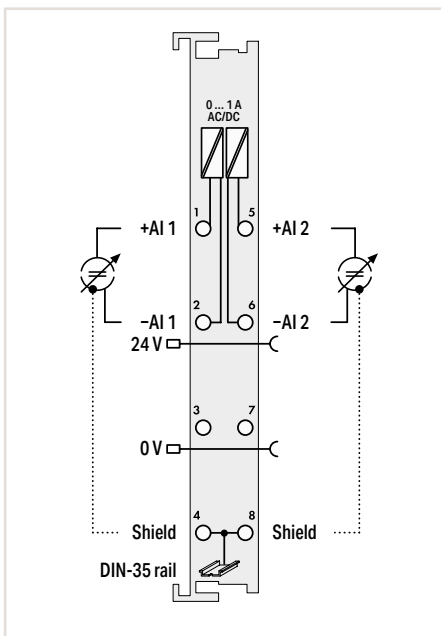
## Analog Input; 0 ... 1 A or 0 ... 5 AAC/DC; Differential Input

5.4



Figure: 750-475

Figure: 753-475



Item Description	2-Channel Analog Input; 0 ... 1 AAC/DC; Differential input		2-Channel Analog Input; 0 ... 5 AAC/DC; Differential input
Version			0 ... 5 AAC/DC
Item No.	750-475	753-475	750-475/020-000
Order Text	2AI; 0-1A AC/DC; Diff	2AI; 0-1A AC/DC; Diff	2AI; 0-5A AC/DC; Diff
<b>Technical Data</b>			
Pluggable connector			
Number of analog inputs	2		2
Signal type	0 ... 1 A rms (peak value 2.0 A)		0 ... 5 A rms (peak value 6.0 A)
Signal characteristic	Differential		Differential
Input voltage (max.)	24 VAC/DC (-20 ... +20 %)		24 VAC/DC (-20 ... +20 %)
Resolution	15 bits		15 bits
Conversion time	200 ms		200 ms
Load impedance	22 mΩ		22 mΩ
Measuring error (max.) at 25 °C	±0.1 % of the upper-range value		±0.1 % of the upper-range value
Temperature error (max.)	±110 ppm/K of the upper-range value		±110 ppm/K of the upper-range value
Supply voltage (field)	24 VDC (-25 ... +30 %); via power jumper contacts (power supply via blade contact; transmission via spring contact)		24 VDC (-25 ... +30 %); via power jumper contacts (power supply via blade contact; transmission via spring contact)
Current consumption – system supply (5 V)	80 mA		80 mA
Data width	2 x 16-bit data; 2 x 8-bit control/status (optional)		2 x 16-bit data; 2 x 8-bit control/status (optional)
Isolation	500 V (system/field or channel/channel)		500 V (system/field or channel/channel)
Surrounding air temperature (operation)	0 ... +55 °C		0 ... +55 °C
Dimensions W x H x D	12 x 69.8 x 100 mm		12 x 69.8 x 100 mm
Approvals	CE;  Marine;  OrdLoc/HazLoc;  ATEX/IECEx		CE;  Marine;  OrdLoc/HazLoc;  ATEX/IECEx
Data sheet and further information, see:	wago.com/750-475	wago.com/753-475	wago.com/750-475/020-000
<b>Accessories</b>			
Pluggable connector			Item No.
Coding keys			753-110 753-150

„ Mini-WSB marker card and mounting accessories, see Section "Accessories and Tools"

„ Approvals and corresponding ratings, see page 520 or www.wago.com

Analog Input; ±10 VDC; Differential Input



Figure: 750-456

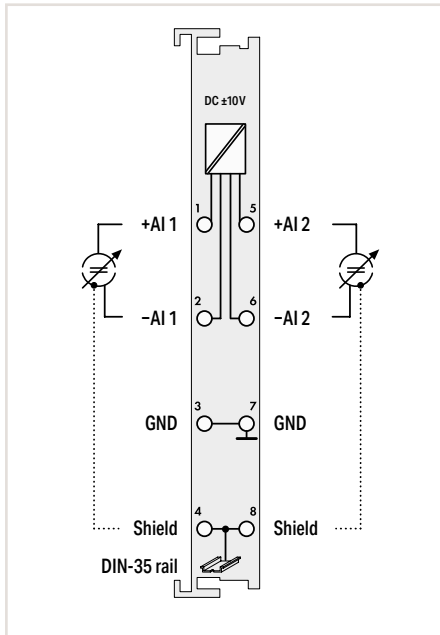
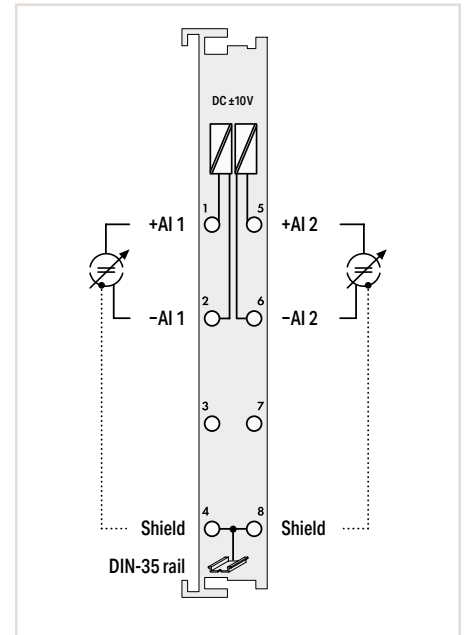


Figure: 750-479



Item Description	2-Channel Analog Input; ±10 VDC; Differential input			2-Channel Analog Input; ±10 VDC; Differential input		
Version	Standard	Data format (S5 control)	Pluggable (delivery without connector)	Standard	Synchronous	Pluggable (delivery without connector)
Item No.	750-456	750-456/000-200	753-456	750-479	750-479/000-001	753-479
Order Text	2AI; ±10 VDC; Diff	2AI; ±10 VDC; Diff; S5	2AI; ±10 VDC; Diff	2AI; ±10 VDC; Diff	2AI; ±10 VDC; Diff; Sync	2AI; ±10 VDC; Diff
<b>Technical Data</b>						
Extended functionality				Time-synchronized measured value acquisition within the module	Time-synchronized measured value acquisition within the module	Time-synchronized measured value acquisition within the module
Pluggable connector			●			●
Customized data format for S5 control*		●				
Number of analog inputs		2			2	
Signal type		±10 V			±10 V	
Signal characteristic		Differential			Differential	
Resolution		12 bits			13 bits + sign	
Conversion time		2 ms			1 ms	
Internal resistance		570 kΩ			1 MΩ	
Input filter (analog)					5 kHz	
Admissible continuous overload					60 V	
Measuring error (max.) at 25 °C		±0.2 % of the upper-range value			±0.05 % of the upper-range value	
Temperature error (max.)		±0.015 %/K of the upper-range value			±0.01 % of the upper-range value	
Current consumption – system supply (5 V)		80 mA			100 mA	
Data width		2 x 16-bit data; 2 x 8-bit control/status (optional)			2 x 16-bit data; 2 x 8-bit control/status (optional)	
Isolation		500 V (system/field)			500 V (system/field or channel/channel)	
Surrounding air temperature (operation)		0 ... +55 °C			0 ... +55 °C	
Dimensions W x H x D		12 x 69.8 x 100 mm			12 x 69.8 x 100 mm	
<b>Approvals</b>		CE;   Marine;  OrdLoc/HazLoc; ATEX/IECEX			CE;   Marine;  OrdLoc/HazLoc; ATEX/IECEX	
<b>Data sheet and further information, see:</b>		<a href="http://wago.com/750-456">wago.com/750-456</a>	<a href="http://wago.com/753-456">wago.com/753-456</a>		<a href="http://wago.com/750-479">wago.com/750-479</a>	<a href="http://wago.com/753-479">wago.com/753-479</a>
<b>Accessories</b>			<b>Item No.</b>			<b>Item No.</b>
Pluggable connector			753-110			753-110
Coding keys			753-150			753-150

\*The S5 format allows you to import data with the standard S5 FB 250 function block.

## Analog Input; ±10 VDC; Single-Ended

5.4



Figure: 750-476

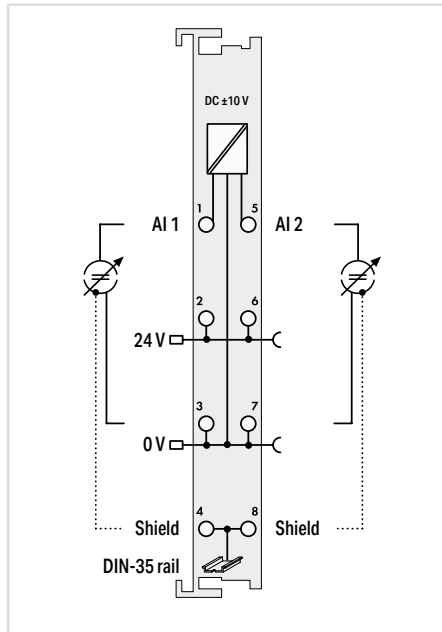
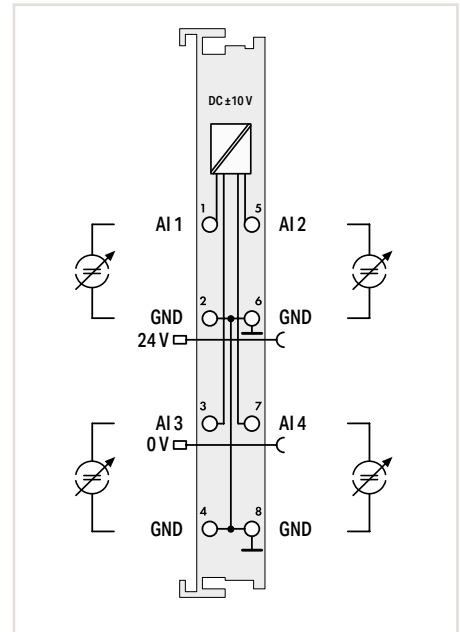


Figure: 750-457



Item Description	2-Channel Analog Input; ±10 VDC; Single-ended; 16 bits			4-Channel Analog Input; ±10 VDC; Single-ended		
Version	Standard	Data format (S5 control)	Pluggable (delivery without connector)	Standard	Extended temperature	Pluggable (delivery without connector)
Item No.	750-476	750-476/000-200	753-476	750-457	750-457/025-000	753-457
Order Text	2AI; ±10 VDC; SE; 16bits	2AI; ±10 VDC; SE; 16bits; S5	2AI; ±10 VDC; SE; 16bits	4AI; ±10 VDC; SE	4AI; ±10 VDC; SE; T	4AI; ±10 VDC; SE
<b>Technical Data</b>						
Pluggable connector			•			•
Customized data format for S5 control*		•				
Number of analog inputs	2			4		
Signal type	±10 V			±10 V		
Signal characteristic	Single-ended			Single-ended		
Resolution	15 bits + sign			12 bits		
Conversion time	80 ms			10 ms		
Internal resistance	130 kΩ			> 100 kΩ		
Input voltage (max.)	24 V			±40 V		
Input filter (analog)	50 Hz	60 Hz	50 Hz			
Measuring error (max.) at 25 °C	±0.1 % of the upper-range value			±0.1 % of the upper-range value		
Temperature error (max.)	±0.01 % of the upper-range value			±0.01 % of the upper-range value		
Supply voltage (field)	24 VDC (-25 ... +30 %); via power jumper contacts (power supply via blade contact; transmission via spring contact)			24 VDC (-25 ... +30 %); via power jumper contacts (power supply via blade contact; transmission via spring contact)		
Current consumption – system supply (5 V)	75 mA			65 mA		
Data width	2 x 16-bit data; 2 x 8-bit control/status (optional)			4 x 16-bit data; 4 x 8-bit control/status (optional)		
Isolation	500 V (system/field)			500 V (system/field)		
Surrounding air temperature (operation)	0 ... +55 °C			0 ... +55 °C	-20 ... +60 °C	0 ... +55 °C
Dimensions W x H x D	12 x 69.8 x 100 mm			12 x 69.8 x 100 mm		
Approvals	CE; Marine; OrdLoc/HazLoc; ATEX/IECEx			CE; Marine; OrdLoc/HazLoc; ATEX/IECEx		
Data sheet and further information, see:	wago.com/750-476		wago.com/753-476	wago.com/750-457		wago.com/753-457
<b>Accessories</b>			<b>Item No.</b>			<b>Item No.</b>
Pluggable connector			753-110			753-110
Coding keys			753-150			753-150

\*The S5 format allows you to import data with the standard S5 FB 250 function block.

„ Mini-WSB marker card and mounting accessories, see Section "Accessories and Tools"

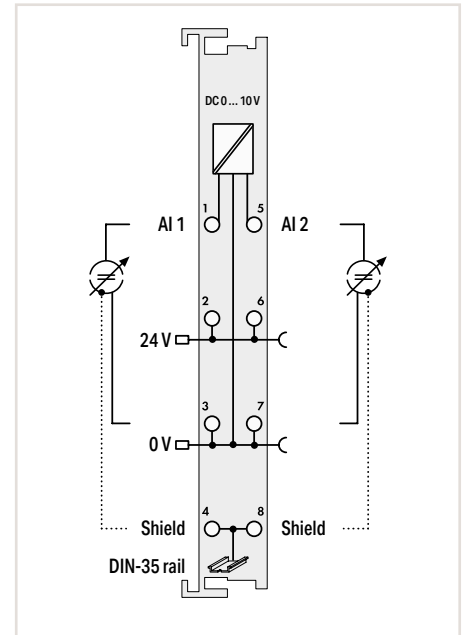
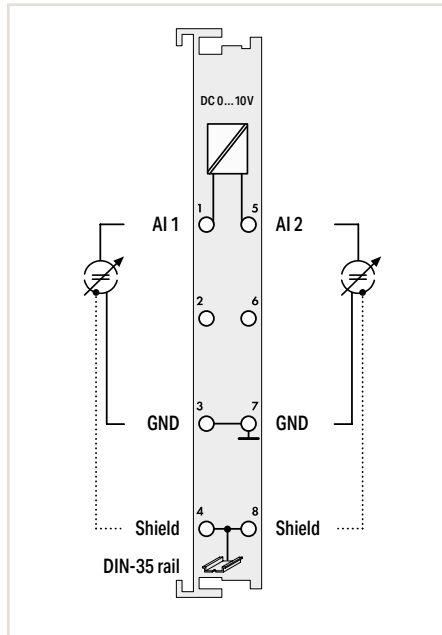
„ Approvals and corresponding ratings, see page 520 or www.wago.com

### Analog Input; 0 ... 10 VDC; Single-Ended



Figure: 750-467

Figure: 750-478



Item Description	2-Channel Analog Input; 0 ... 10 VDC; Single-ended		2-Channel Analog Input; 0 ... 10 VDC; Single-ended; 16 bits		
Version	Standard	Pluggable (delivery without connector)	Standard	60 Hz	Pluggable (delivery without connector)
Item No.	750-467	753-467	750-478	750-478/005-000	753-478
Order Text	2AI; 0-10 VDC; SE	2AI; 0-10 VDC; SE	2AI; 0-10 VDC; SE; 16bits	2AI; 0-10 VDC; SE; 16bits; 60Hz	2AI; 0-10 VDC; SE; 16bits

Technical Data	750-467		750-478		
Pluggable connector		•			•
Number of analog inputs	2		2		
Signal type	0 ... 10 V		0 ... 10 V		
Signal characteristic	Single-ended		Single-ended		
Resolution	12 bits		16 bits		
Conversion time	2 ms		80 ms		
Internal resistance	130 kΩ		130 kΩ		
Input voltage (max.)	35 V		24 V		
Input filter (analog)			50 Hz	60 Hz	50 Hz
Measuring error (max.) at 25 °C	±0.2 % of the upper-range value		±0.1 % of the upper-range value		
Temperature error (max.)	±0.01 % of the upper-range value		±0.01 % of the upper-range value		
Supply voltage (field)			24 VDC (-25 ... +30 %); via power jumper contacts (power supply via blade contact; transmission via spring contact)		
Current consumption – system supply (5 V)	60 mA		75 mA		
Data width	2 x 16-bit data; 2 x 8-bit control/status (optional)		2 x 16-bit data; 2 x 8-bit control/status (optional)		
Isolation	500 V (system/field)		500 V (system/field)		
Surrounding air temperature (operation)	0 ... +55 °C		0 ... +55 °C		
Dimensions W x H x D	12 x 69.8 x 100 mm		12 x 69.8 x 100 mm		
Approvals	CE, IEC, OrdLoc/HazLoc, ATEX/IECEX		CE, IEC, Marine, OrdLoc/HazLoc, ATEX/IECEX		
Data sheet and further information, see:	<a href="http://wago.com/750-467">wago.com/750-467</a>	<a href="http://wago.com/753-467">wago.com/753-467</a>	<a href="http://wago.com/750-478">wago.com/750-478</a>		<a href="http://wago.com/753-478">wago.com/753-478</a>

Accessories	Item No.
Pluggable connector	753-110
Coding keys	753-150

## Analog Input; 0 ... 10 VDC; Single-Ended

5.4



Figure: 750-468

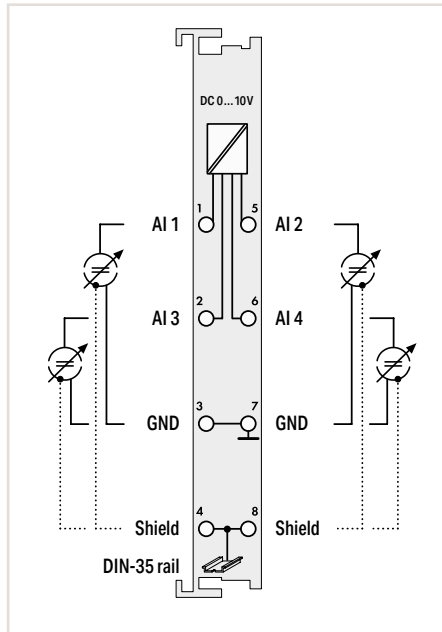
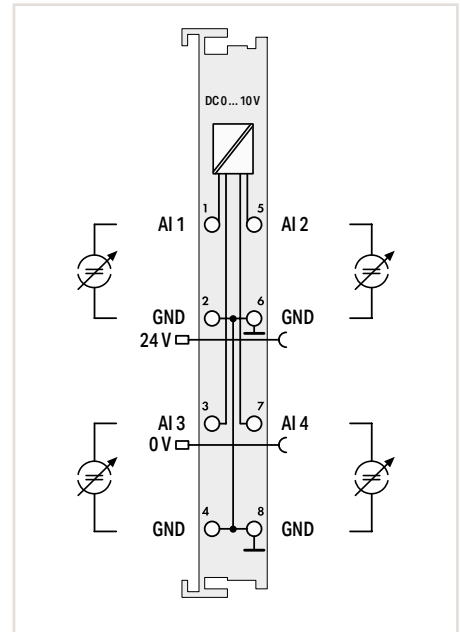


Figure: 750-459



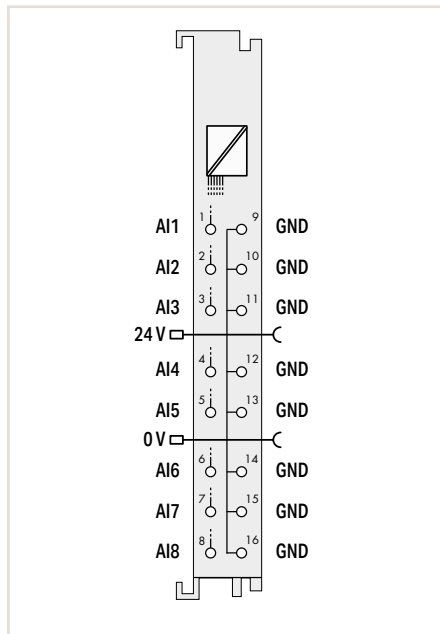
Item Description	4-Channel Analog Input; 0 ... 10 VDC; Single-ended		4-Channel Analog Input; 0 ... 10 VDC; Single-ended	
Version	Standard	Extended temperature	Standard	Pluggable (delivery without connector)
Item No.	750-468	750-468/025-000	750-459	753-459
Order Text	4AI; 0-10 VDC; SE	4AI; 0-10 VDC; SE; T	4AI; 0-10 VDC; SE	4AI; 0-10 VDC; SE
<b>Technical Data</b>				
Pluggable connector			•	
Number of analog inputs	4		4	
Signal type	0 ... 10 V		0 ... 10 V	
Signal characteristic	Single-ended		Single-ended	
Resolution	12 bits		12 bits	
Conversion time	4 ms		10 ms	
Internal resistance	133 kΩ		> 100 kΩ	
Input voltage (max.)	35 V		±40 V	
Measuring error (max.) at 25 °C	±0.2 % of the upper-range value		±0.1 % of the upper-range value	
Temperature error (max.)	±0.01 % of the upper-range value		±0.01 % of the upper-range value	
Supply voltage (field)			24 VDC (-25 ... +30 %); via power jumper contacts (power supply via blade contact; transmission via spring contact)	
Current consumption – system supply (5 V)	60 mA		65 mA	
Data width	4 x 16-bit data; 4 x 8-bit control/status (optional)		4 x 16-bit data; 4 x 8-bit control/status (optional)	
Isolation	500 V (system/field)		500 V (system/field)	
Surrounding air temperature (operation)	0 ... +55 °C		0 ... +55 °C	
Dimensions W x H x D	12 x 69.8 x 100 mm		12 x 69.8 x 100 mm	
<b>Approvals</b>	CE; Marine; OrdLoc/HazLoc; ATEX/IECEX		CE; Marine; OrdLoc/HazLoc; ATEX/IECEX	
Data sheet and further information, see:	<a href="http://wago.com/750-468">wago.com/750-468</a>		<a href="http://wago.com/750-459">wago.com/750-459</a>	<a href="http://wago.com/753-459">wago.com/753-459</a>
<b>Accessories</b>			<b>Item No.</b>	
Pluggable connector			753-110	
Coding keys			753-150	

„ Mini-WSB marker card and mounting accessories, see Section "Accessories and Tools"

„ Approvals and corresponding ratings, see page 520 or [www.wago.com](http://www.wago.com)



## Analog Input; Configurable $\pm 10$ VDC/0 ... 10 V; Single-Ended



<b>Item Description</b>	<b>8-Channel Analog Input; 0 ... 10 VDC/<math>\pm 10</math> V; Single-ended</b>
<b>Version</b>	<b>Standard</b>
<b>Item No.</b>	<b>750-497</b>
<b>Order Text</b>	8AI; 0-10 V/ $\pm 10$ VDC; SE
<b>Technical Data</b>	
Number of analog inputs	8
Signal type	Configurable: 0 ... 10 V / $\pm 10$ V
Resolution	12 bits
Internal resistance	> 100 k $\Omega$
Measuring error (max.) at 25 °C	$\pm 0.1$ % of the upper-range value
Temperature error (max.)	$\pm 0.01$ % of the upper-range value
Supply voltage (field)	24 VDC (-25 ... +30 %); via power jumper contacts (power supply via blade contact; transmission via spring contact)
Current consumption – system supply (5 V)	105 mA
Data width	8 x 16-bit data; 8 x 8-bit control/status (optional)
Isolation	500 V (system/field)
Surrounding air temperature (operation)	0 ... +55 °C
Dimensions W x H x D	12 x 69 x 100 mm
<b>Approvals</b>	CE; ;  Marine;  OrdLoc/HazLoc
<b>Data sheet and further information, see:</b>	<a href="http://wago.com/750-497">wago.com/750-497</a>

## Analog Input; 0 ... 10 VAC/DC or 0 ... 30 VDC; Differential Input

5.4



Figure: 750-477

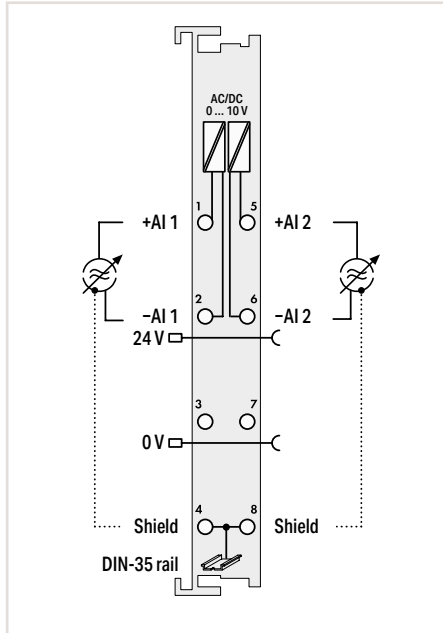
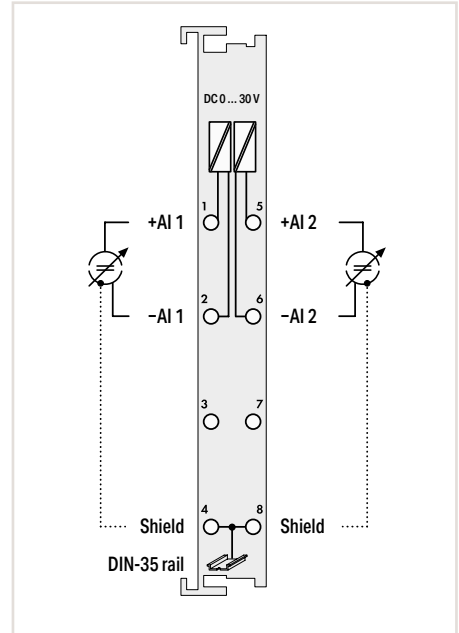


Figure: 750-483

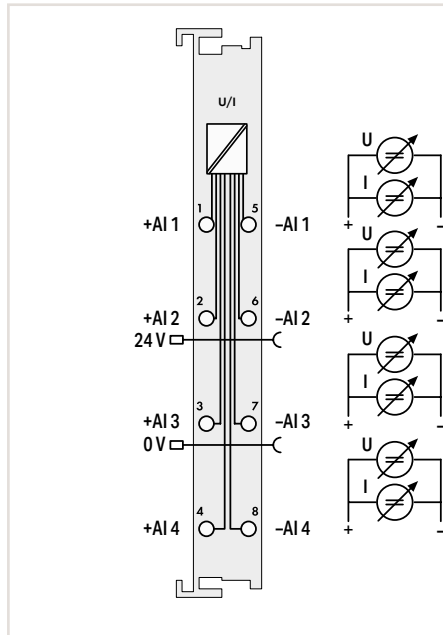


Item Description		2-Channel Analog Input; 0 ... 10 VAC/DC; Differential input		2-Channel Analog Input; 0 ... 30 VDC; Differential input	
Version		Standard	Pluggable (delivery without connector)	Standard	Pluggable (delivery without connector)
Item No.		750-477	753-477	750-483	753-483
Order Text		2AI; 0-10 VAC/VDC; Diff	2AI; 0-10 VAC/VDC; Diff	2AI; 0-30 VDC; Diff	2AI; 0-30 VDC; Diff
Technical Data					
Extended functionality				Time-synchronized measured value acquisition within the module	
Pluggable connector					
Number of analog inputs		2		2	
Signal type		0 ... 10 V rms (peak value 20 V)		0 ... 30 V	
Signal characteristic		Differential		Differential	
Resolution		15 bits		14 bits	
Conversion time		200 ms		1 ms	
Internal resistance		120 kΩ		1 MΩ	
Measuring error (max.) at 25 °C		±0.1 % of the upper-range value		±0.05 % of the upper-range value	
Temperature error (max.)		±110 ppm/K of the upper-range value		±0.01 % of the upper-range value	
Supply voltage (field)		24 VDC (-25 ... +30 %); via power jumper contacts (power supply via blade contact; transmission via spring contact)			
Current consumption – system supply (5 V)		80 mA		80 mA	
Data width		2 x 16-bit data; 2 x 8-bit control/status (optional)		2 x 16-bit data; 2 x 8-bit control/status (optional)	
Isolation		500 V (system/field or channel/channel)		500 V (system/field or channel/channel)	
Surrounding air temperature (operation)		0 ... +55 °C		0 ... +55 °C	
Dimensions W x H x D		12 x 69.8 x 100 mm		12 x 69.8 x 100 mm	
Approvals		CE;  OrdLoc/HazLoc;  ATEX/IECEx		CE;  Marine;  OrdLoc/HazLoc;  ATEX/IECEx	
Data sheet and further information, see:		<a href="http://wago.com/750-477">wago.com/750-477</a>	<a href="http://wago.com/753-477">wago.com/753-477</a>	<a href="http://wago.com/750-483">wago.com/750-483</a>	<a href="http://wago.com/753-483">wago.com/753-483</a>
Accessories		Item No.		Item No.	
Pluggable connector		753-110		753-110	
Coding keys		753-150		753-150	

„ Mini-WSB marker card and mounting accessories, see Section "Accessories and Tools"

„ Approvals and corresponding ratings, see page 520 or [www.wago.com](http://www.wago.com)

## Analog Input; Voltage/Current; Differential Input



### Item Description

4-Channel Analog Input; Voltage/current; Differential input; 16 bits; Diagnostics

### Item No.

750-471

### Order Text

4AI; U/I; Diff; Galv

### Technical Data

Number of analog inputs

4 (electrically isolated)

Signal type

Voltages and currents  
(Configurable channel for channel)

Signal characteristic

Differential

Measurement range

0 ... 20 mA; 4 ... 20 mA; 3.6 ... 21 mA NE43; ±20 mA  
0 ... 10 V; ±10 V; ±200 mV

Sensor connection

2-wire

Input impedance

AI (U) >100 kΩ;  
AI (I) <130 Ω (typ. 113 Ω)

Resolution

16 bits

Conversion time

≤ 5 ms

Measuring error (max.) at 25 °C

±0.1 % of the upper-range value  
±0.2 % at ±200 mV

Temperature error (max.)

±0.01 %/K of the upper-range value

Supply voltage (field)

24 VDC (-25 ... +30 %); via power jumper contacts  
(power supply via blade contact; transmission via spring contact)

Current consumption – system supply (5 V)

100 mA

Data width

4 x 16-bit data; 4 x 8-bit control/status (optional)

Isolation

2 kV (channel/channel); 2 kV (system/field)

Surrounding air temperature (operation)

0 ... +55 °C

Dimensions W x H x D

12 x 67.8 x 100 mm

### Approvals

CE; Marine; OrdLoc/HazLoc; ATEX/IECEX

Data sheet and further information, see:

[wago.com/750-471](http://wago.com/750-471)

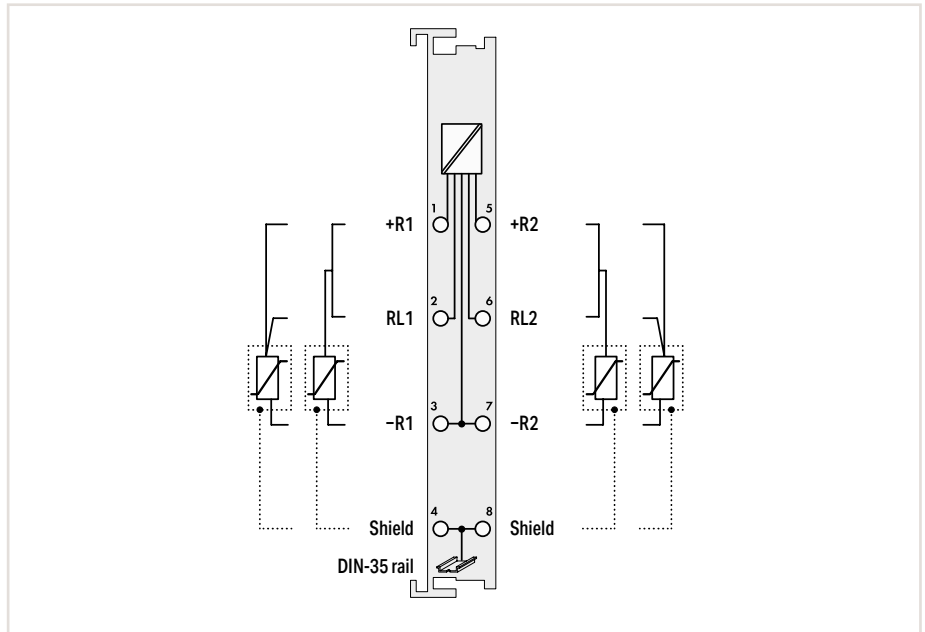
## Analog Input; for Resistance Sensors

5.4



Figure: 750-461

Figure: 753-461



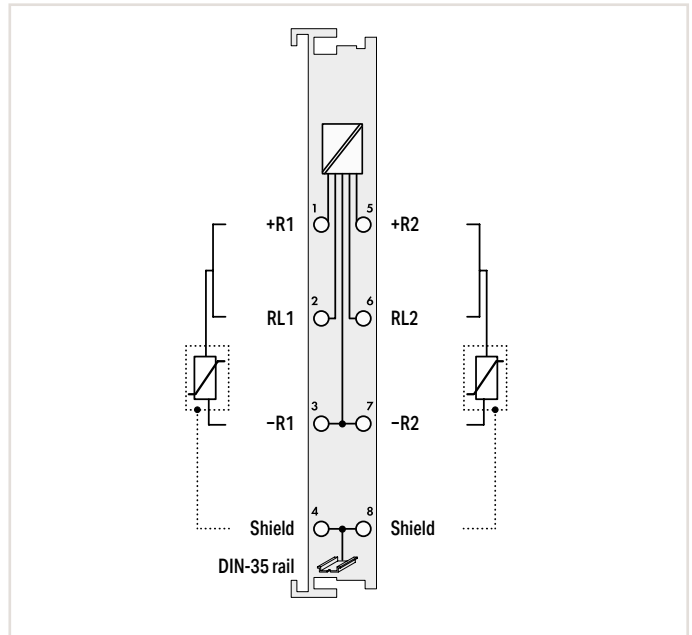
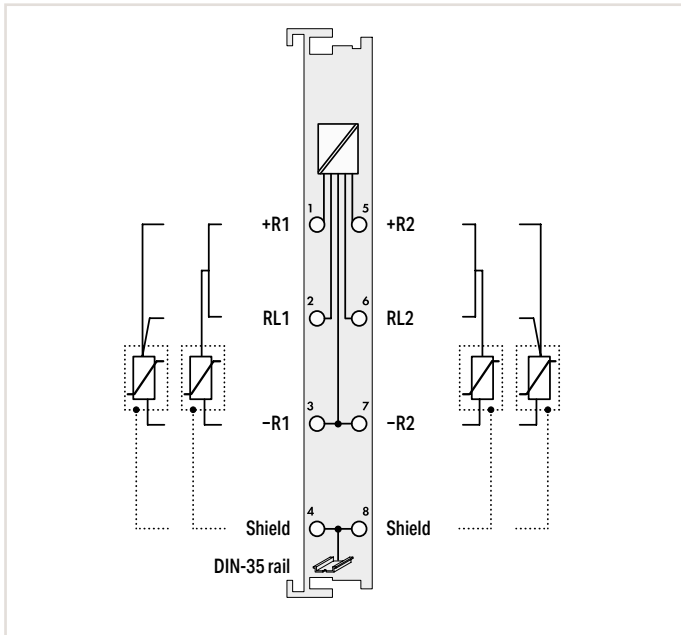
Item Description	2-Channel Analog Input; for Pt100/RTD resistance sensors					
Version	Standard	Pluggable (delivery with-out connector)	Adjustable	Pluggable (delivery with-out connector); Adjustable	Extended temperature	Data format (S5 control)
Item No.	750-461	753-461	750-461/003-000	753-461/003-000	750-461/025-000	750-461/000-200
Order Text	2AI; Pt100/RTD	2AI; Pt100/RTD	2AI; Pt100/RTD; Adjust	2AI; Pt100/RTD; Adjust	2AI; Pt100/RTD; T	2AI; Pt100/RTD; S5

Technical Data					
Pluggable connector		•		•	
Customized data format for S5 control*				•	
Number of analog inputs	2				
Signal type	Pt100	Pt100 Configurable: Pt; Ni; Ohm	Pt100		
Sensor connection	2-wire; 3-wire				
Temperature range	-200 ... +850 °C				
Resolution	0.1 °C				
Conversion time	320 ms (per channel)				
Measured current (typ.)	0.5 mA				
Measuring error (max.) at 25 °C	±0.2 % of the upper-range value				
Temperature error (max.)	±0.01 % of the upper-range value				
Current consumption – system supply (5 V)	80 mA				
Data width	2 x 16-bit data; 2 x 8-bit control/status (optional)				
Isolation	500 V (system/field)				
Surrounding air temperature (operation)	0 ... +55 °C		-20 ... +60 °C	0 ... +55 °C	
Dimensions W x H x D	12 x 69.8 x 100 mm				
Approvals	CE; Marine; OrdLoc/HazLoc; ATEX/IECEX				
Data sheet and further information, see:	<a href="http://wago.com/750-461">wago.com/750-461</a>	<a href="http://wago.com/753-461">wago.com/753-461</a>	<a href="http://wago.com/750-461">wago.com/750-461</a>	<a href="http://wago.com/753-461">wago.com/753-461</a>	<a href="http://wago.com/750-461">wago.com/750-461</a>

Accessories	Item No.	Item No.
Pluggable connector	753-110	753-110
Coding keys	753-150	753-150

\*The S5 format allows you to import data with the standard S5 FB 250 function block.

„ Approvals and corresponding ratings, see page 520 or [www.wago.com](http://www.wago.com)



2-Channel Analog Input; for resistance sensors		
Pt1000/RTD	Ni1000/ RTD	Ni1000 TK5000
750-461/000-003	750-461/000-005	750-461/000-009
2AI; Pt1000/RTD	2AI; Ni1000/RTD	2AI; Ni1000 TK5000

2-Channel Analog Input; Resistance measurement		
NTC 20k	10 ... 1200 Ohm	10 ... 5000 Ohm
750-461/020-000	750-461/000-002	750-461/000-007
2AI; NTC 20k	2AI; 10R-1k2	2AI; 10R-5k0

2		
Pt1000	Ni1000 TK6180	Ni1000 TK5000
2-wire; 3-wire		
-200 ... +850 °C	-60 ... +250 °C	-30 ... +122 °C
0.1 °C		
320 ms (per channel)		
0.5 mA		
±0.2 % of the upper-range value		
±0.01 % of the upper-range value		
80 mA		
2 x 16-bit data; 2 x 8-bit control/status (optional)		
500 V (system/field)		
0 ... +55 °C		
12 x 69.8 x 100 mm		
Marine;  OrdLoc/HazLoc;  ATEX/IECEX <a href="http://wago.com/750-461">wago.com/750-461</a>		

2		
NTC 20k	10R ... 1k2	10R ... 5k0
2-wire		
-30 ... +130 °C		
0.1 °C	0.1 Ohm	0.5 Ohm
320 ms (per channel)		
0.05 mA	0.5 mA	
0.5 ... 3 K (temperature-dependent)	±0.2 % of the upper-range value	
±0.002 % of the upper-range value	±0.01 % of the upper-range value	
65 mA	80 mA	
2 x 16-bit data; 2 x 8-bit control/status (optional)		
500 V (system/field)		
0 ... +55 °C		
12 x 69.8 x 100 mm		
Marine;  OrdLoc/HazLoc;  ATEX/IECEX <a href="http://wago.com/750-461">wago.com/750-461</a>		

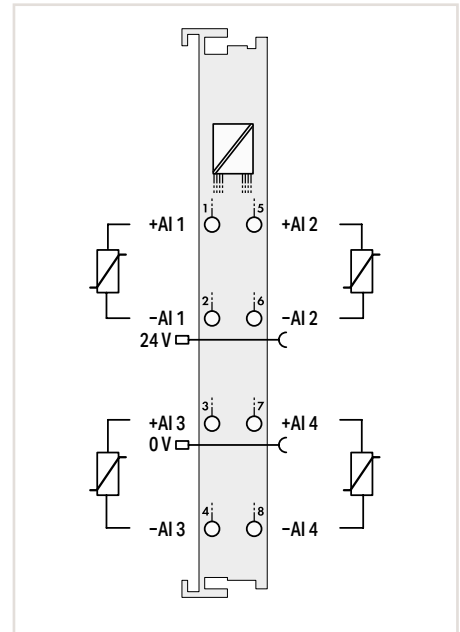
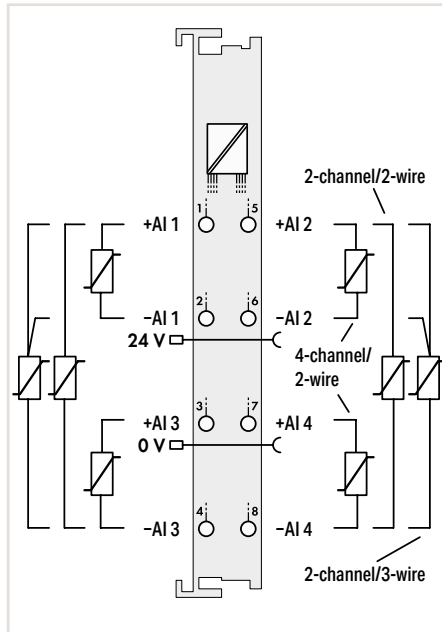
## Analog Input; for Resistance Sensors

5.4



Figure: 750-464

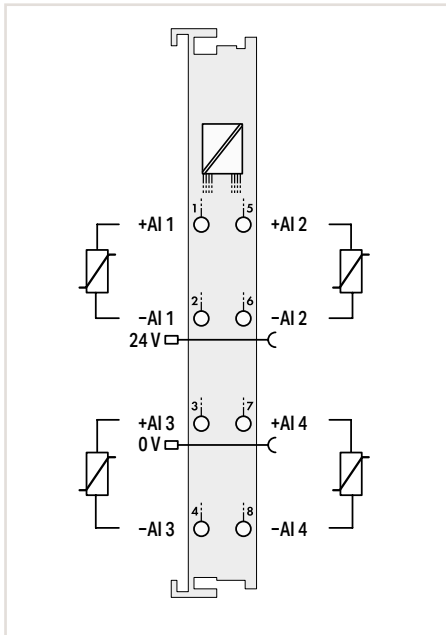
Figure: 750-450



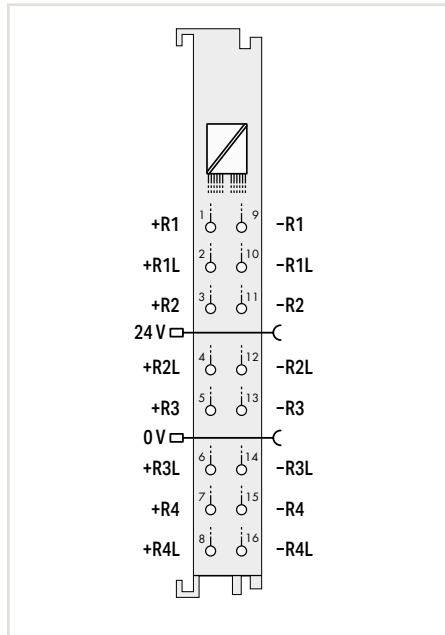
Item Description	2/4-Channel Analog Input; Resistance measurement; Adjustable	4-Channel Analog Input; for resistance sensors; Adjustable
Version	Standard	NTC
Item No.	750-464	750-464/020-000
Order Text	2/4AI; RTD; Adjust	4AI; NTC; Adjust
<b>Technical Data</b>		
Number of analog inputs	2/4	4
Signal type	Pt100; Configurable: Pt200; Pt500; Pt1000; Ni100; Ni120; Ni1000; Potentiometer (2-channel operation only); 10 Ohm ... 1.2 kOhm; 10 Ohm ... 5 kOhm	NTC 10 kOhm; Configurable: NTC 10 kOhm Thermokon; NTC 20 kOhm
Sensor connection	2-wire; 3-wire	2-wire
Temperature range	-200 ... +850 °C (Pt100 ... Pt1000); -60 ... +300 °C (Ni100, Ni1000); -60 ... +250 °C (Ni1000 TK5000); -80 ... +260 °C (Ni120)	-50 ... +150 °C
Resolution	0.1 °C	0.1 °C
Conversion time	320 ms (per channel)	320 ms (per channel)
Measured current (typ.)	≤ 350 μA	≤ 350 μA
Measuring error (max.) at 25 °C	1 K over entire temperature range; 0.5 K over limited temperature range (-30 ... +120 °C; Pt1000)	2 K within the entire temperature range
Temperature error (max.)	20 ppm/K	20 ppm/K
Supply voltage (field)	24 VDC (-25 ... +30 %); via power jumper contacts (power supply via blade contact; transmission via spring contact)	24 VDC (-25 ... +30 %); via power jumper contacts (power supply via blade contact; transmission via spring contact)
Current consumption – system supply (5 V)	50 mA	50 mA
Data width	4 (2) x 16-bit data; 4 (2) x 8-bit control/status (optional)	4 x 16-bit data; 4 x 8-bit control/status (optional)
Isolation	500 V (system/field)	500 V (system/field)
Surrounding air temperature (operation)	0 ... +55 °C	0 ... +55 °C
Dimensions W x H x D	12 x 69.8 x 100 mm	12 x 69.8 x 100 mm
Approvals	CE; Marine; OrdLoc/HazLoc; ATEX/IECEx	CE; Marine; OrdLoc/HazLoc; ATEX/IECEx
Data sheet and further information, see:	wago.com/750-464	wago.com/750-464/020-000

„ Mini-WSB marker card and mounting accessories, see Section "Accessories and Tools"

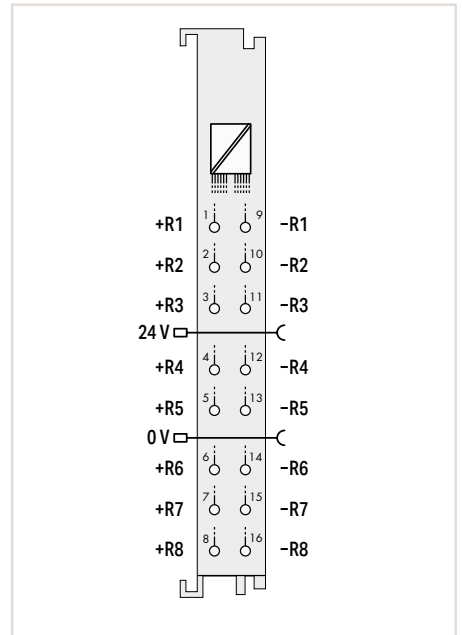
„ Approvals and corresponding ratings, see page 520 or www.wago.com



**4-Channel Analog Input; Resistance measurement**  
**Measurement range: -30 °C ... +150 °C**  
**750-463**  
 4AI; RTD; -30°C...+150°C



**4-Channel Analog Input; Resistance measurement; Adjustable**  
**Standard**  
**750-450**  
 4AI; RTD; Adjust



**8-Channel Analog Input; Resistance measurement; Adjustable**  
**Standard**                      **Extended temperature**  
**750-451**                              **750-451/025-000**  
 8AI; RTD; Adjust                      8AI; RTD; Adjust; T

4
Pt1000; Configurable: Ni1000; KTY 81
2-wire
-30 ... +150 °C
0.1 °C
≤ 350 µA
0.5 K in temperature range: -30 ... +150 °C
20 ppm/K
24 VDC (-25 ... +30 %); via power jumper contacts (power supply via blade contact; transmission via spring contact)
50 mA
4 x 16-bit data; 4 x 8-bit control/status (optional)
500 V (system/field)
0 ... +55 °C
12 x 69.8 x 100 mm
CE; Marine; OrdLoc/HazLoc; ATEX/IECEX
wago.com/750-463

4
Pt100; Configurable: Pt200; Pt500; Pt1000; Ni100; Ni120; Ni1000 (TK6180 + TK5000); Potentiometer 0 Ohm ... 1.2 kOhm; 0 Ohm ... 5 kOhm
2-wire; 3-wire; 4-wire
-200 ... +850 °C (Pt100, Pt200, Pt500, Pt1000); -60 ... +250 °C (Ni100, Ni1000); -80 ... +260 °C (Ni120)
0.1 °C
Per channel: ≤ 100 ms (2-/4-wire connection), ≤ 200 ms (3-wire connection)
≤ 350 µA
±0.6 K (Pt100, Pt200, Pt500, Ni100, Ni120); ±0.2 K (Pt1000, Ni1000); ±0.3 ... 0.7 Ω at resistance measurement
±5 ppm/K
24 VDC (-25 ... +30 %); via power jumper contacts (power supply via blade contact; transmission via spring contact)
85 mA
4 x 16-bit data; 4 x 8-bit control/status (optional)
500 V (system/field)
0 ... +55 °C
12 x 69.8 x 100 mm
CE; Marine; OrdLoc/HazLoc; ATEX/IECEX
wago.com/750-450

8
Pt100; Configurable: Pt200; Pt500; Pt1000; Ni100; Ni120; Ni1000 (TK6180 + TK5000); Potentiometer 0 Ohm ... 1.2 kOhm; 0 Ohm ... 5 kOhm
2-wire
-200 ... +850 °C (Pt100, Pt200, Pt500, Pt1000); -60 ... +250 °C (Ni100, Ni1000); -80 ... +260 °C (Ni120)
0.1 °C
Per channel: ≤ 100 ms
≤ 350 µA
±0.6 K (Pt100, Pt200, Pt500, Ni100, Ni120); ±0.2 K (Pt1000, Ni1000); ±0.3 Ω at resistance measurement
±5 ppm/K
24 VDC (-25 ... +30 %); via power jumper contacts (power supply via blade contact; transmission via spring contact)
110 mA
8 x 16-bit data; 8 x 8-bit control/status (optional)
500 V (system/field)
0 ... +55 °C                      -20 ... +60 °C
12 x 69.8 x 100 mm
CE; Marine; OrdLoc/HazLoc; ATEX/IECEX
wago.com/750-451

## Analog Input; for Thermocouples

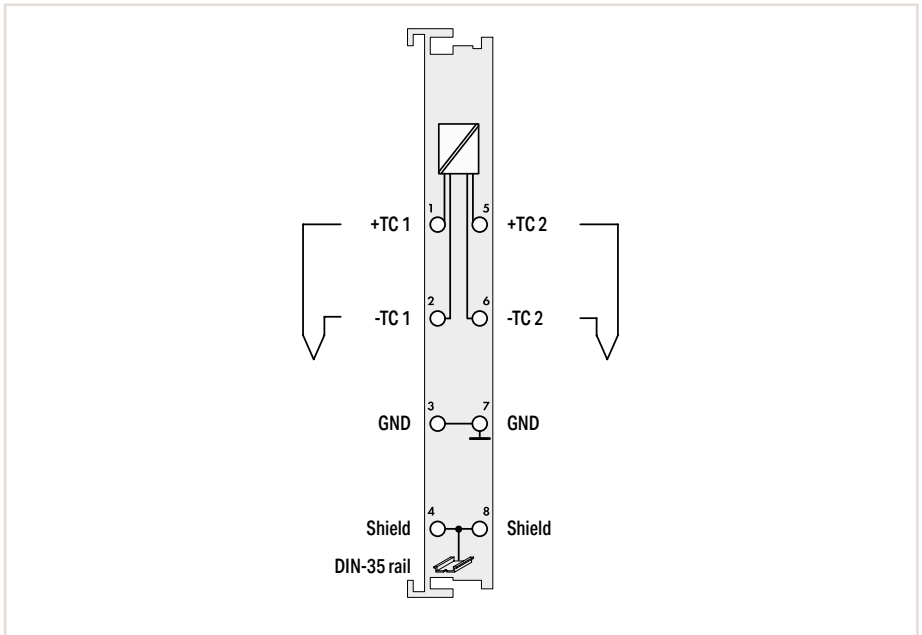
5.4



Figure: 750-469



Figure: 750-458



### Item Description

#### Version

#### Item No.

#### Order Text

### Technical Data

Pluggable connector  
 Customized data format for S5 control\*  
 Number of analog inputs  
 Signal type  
 Temperature range  
 Resolution  
 Conversion time  
 Measuring error (max.) at 25 °C

Temperature error (max.)  
 Cold junction compensation  
 Supply voltage (field)

Current consumption – system supply (5 V)  
 Data width  
 Isolation  
 Surrounding air temperature (operation)  
 Dimensions W x H x D

### Approvals

### Data sheet and further information, see:

### Accessories

Pluggable connector  
 Coding keys

### 2-Channel Analog Input; Thermocouple K; Diagnostics

Standard	Pluggable (delivery without connector)	Adjustable	Pluggable (delivery without connector); Adjustable	Data format (S5 control)
750-469	753-469	750-469/003-000	753-469/003-000	750-469/000-200
2AI; TC K; Diagn	2AI; TC K; Diagn	2AI; TC K; Diagn Adjust	2AI; TC K; Diagn Adjust	2AI; TC K; Diagn; S5

	•		•	•
2				
Thermocouple K	Thermocouple K; Configurable: L; J; E; T; N; U; B; R; S; mV			Thermocouple K
-100 ... +1370 °C	Sensor-specific			-100 ... +1370 °C
Resolution	0.1 °C			
Conversion time	320 ms			
Measuring error (max.) at 25 °C	±6 K (voltage input: ±2 K; cold junction compensation: ±4 K)			

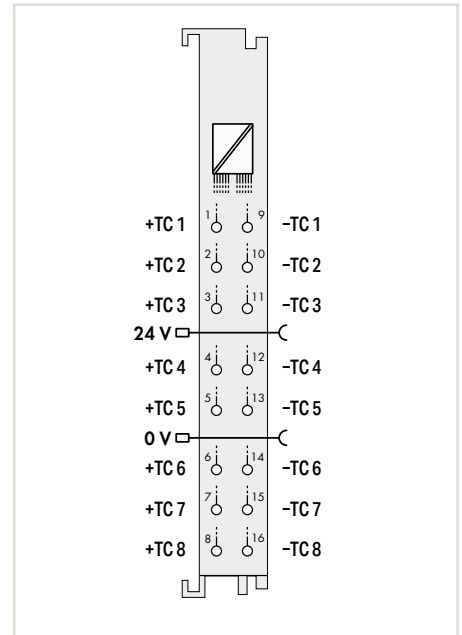
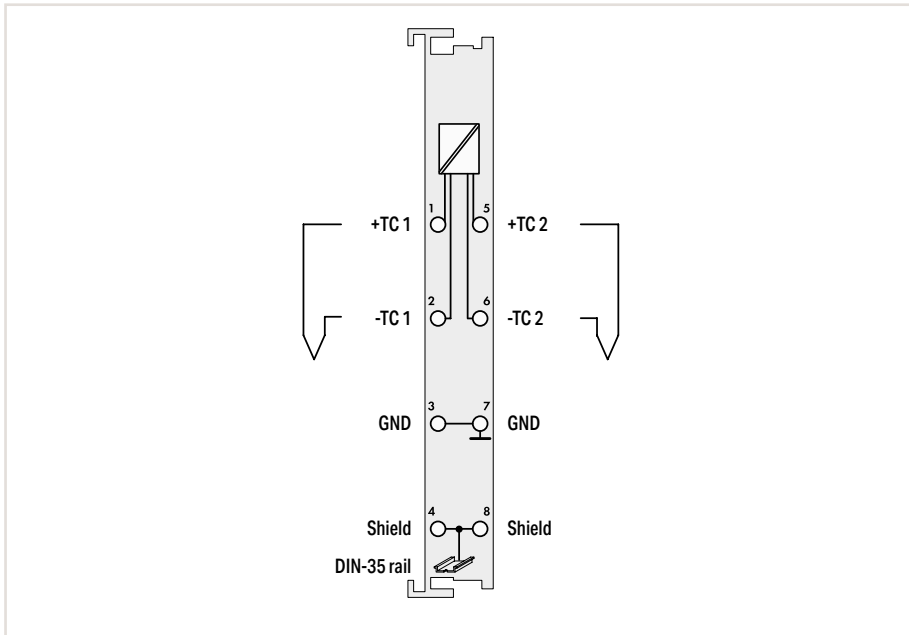
Temperature error (max.)	±0.2 K/K			
Cold junction compensation	Integrated or external			
Supply voltage (field)				
Current consumption – system supply (5 V)	65 mA			
Data width	2 x 16-bit data; 2 x 8-bit control/status (optional)			
Isolation	500 V (system/field)			
Surrounding air temperature (operation)	0 ... +55 °C			
Dimensions W x H x D	12 x 69.8 x 100 mm			
Approvals	CE; Marine; OrdLoc/HazLoc; ATEX/IECEx			

[wago.com/750-469](http://wago.com/750-469) [wago.com/753-469](http://wago.com/753-469) [wago.com/750-469](http://wago.com/750-469) [wago.com/753-469](http://wago.com/753-469) [wago.com/750-469](http://wago.com/750-469)

Item No.	Item No.
753-110	753-110
753-150	753-150

\*The S5 format allows you to import data with the standard S5 FB 250 function block.





2-Channel Analog Input; Thermocouple; Diagnostics					
Thermocouple S	Thermocouple T	Thermocouple J	Thermocouple E	Thermocouple L	Thermocouple $\pm 120$ mV;
750-469/000-001	750-469/000-002	750-469/000-006	750-469/000-008	750-469/000-012	750-469/000-003
2AI; TC S; Diagn	2AI; TC T; Diagn	2AI; TC J; Diagn	2AI; TC E; Diagn	2AI; TC L; Diagn	2AI; TC $\pm 120$ mV; Diagn

8-Channel Analog Input; Thermocouple; Ad-justable	
Standard	750-458
	8AI; TC; Adjust

2					
Thermocouple S	Thermocouple T	Thermocouple J	Thermocouple E	Thermocouple L	$\pm 120$ mV
-50 ... +1700 °C	-100 ... +400 °C	-100 ... +1200 °C	-100 ... +1000 °C	-100 ... +900 °C	

8	
Thermocouple K;	Configurable: J; B; E; N; R; S; T; U; C;
Voltage measurement: -30 ... +30 mV; -60 ... +60 mV; -120 ... +120 mV; -240 ... +240 mV	
Sensor-specific	

0.1 °C
320 ms
$\pm 6$ K (voltage input: $\pm 2$ K; cold junction compensation: $\pm 4$ K)

0.1 °C
Per channel: $\leq 100$ ms
Without cold junction compensation: $\pm 1$ K (type E, N, K, T, J, C); $\pm 2$ K (type S, R); $\pm 3$ K (type B); Cold-junction compensation measurement error: $\pm 4$ K

$\pm 0.2$ K/K
Integrated or external

$\pm 0.05$ K/K
Integrated or external

65 mA
2 x 16-bit data; 2 x 8-bit control/status (optional)
500 V (system/field)
0 ... +55 °C
12 x 69.8 x 100 mm

24 VDC (-25 ... +30 %); via power jumper contacts (power supply via blade contact; transmission via spring contact)
100 mA
8 x 16-bit data; 8 x 8-bit control/status (optional)
500 V (system/field)
0 ... +55 °C
12 x 69.8 x 100 mm

CE; Marine; OrdLoc/HazLoc; ATEX/IECEX
---------------------------------------

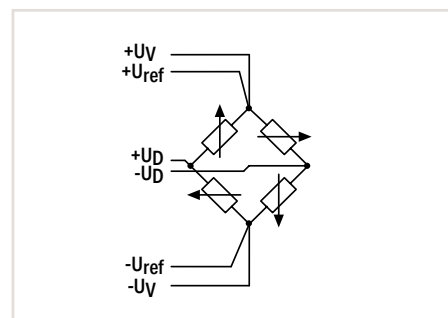
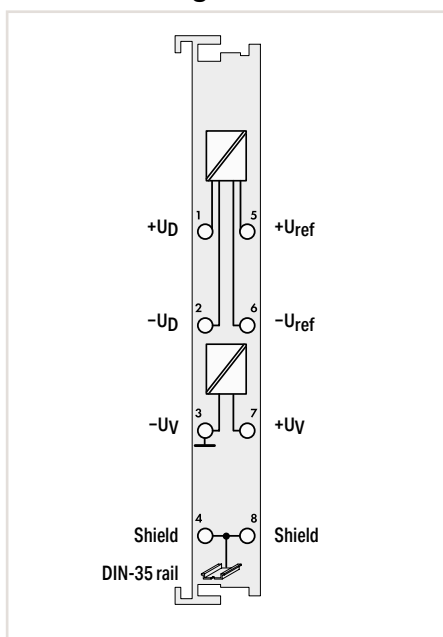
CE; Marine; OrdLoc/HazLoc; ATEX/IECEX
---------------------------------------

wago.com/750-469

wago.com/750-458

## Analog Input; for Resistor Bridges (Strain Gauge)

5.4



## Item Description

## Version

## Item No.

## Order Text

## 1-Channel Analog Input; Resistor bridges (strain gauge)

## Standard

## Conversion time:

125 ms

750-491

750-491/000-001

1AI; DMS

1AI; DMS; 125ms

## Technical Data

Number of analog inputs

1

Signal type

Resistor bridge (strain gauge)

Signal voltage  $U_D$ 

-15 ... +15 mV

Signal voltage  $U_{ref}$ 

+2 ... +6 V

Internal resistance

> 200 k $\Omega$  ( $U_{ref}$ ); > 1 M $\Omega$  ( $U_D$ )Supply voltage  $U_v$ 

5 VDC; 20 mA

Resolution

16 bits

Conversion time

500 ms

125 ms

Measuring error

 $U_D$ :  $\pm 30 \mu\text{V}$ ;  $U_{ref}$ :  $\pm 10 \text{ mV}$ 

Filter

50 Hz

200 Hz

Current consumption – system supply (5 V)

65 mA

Data width

2 x 16-bit data; 2 x 8-bit control/status (optional)

Isolation

500 V (system/field)

Surrounding air temperature (operation)

0 ... +55 °C

Dimensions W x H x D

12 x 69.8 x 100 mm

## Approvals

CE, RoHS, OrdLoc/HazLoc

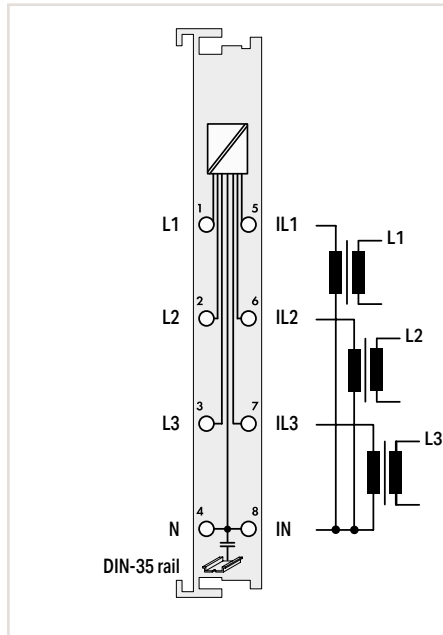
Data sheet and further information, see:

[wago.com/750-491](http://wago.com/750-491)

„ Mini-WSB marker card and mounting accessories, see Section “Accessories and Tools”

„ Approvals and corresponding ratings, see page 520 or [www.wago.com](http://www.wago.com)

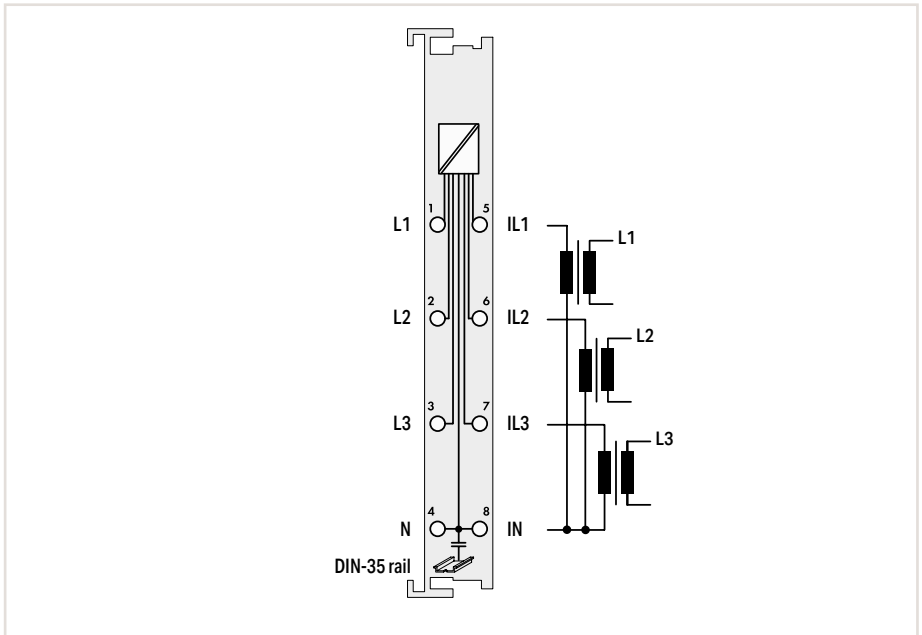
## Analog Input; for 3-Phase Power Measurement



Item Description	3-Phase Power Measurement; 480 VAC 1 A		
Version	Standard	Extended temperature	480 VAC, 5 A
Item No.	750-493	750-493/025-000	750-493/000-001
Order Text	3-PHASE POM; 480VAC 1A	3-PHASE POM; 480VAC 1A; T	3-PHASE POM; 480VAC 5A
<b>Technical Data</b>			
Signal type	3-phase power measurement		
Measured variables	Voltage; Current; Effective power; Reactive power; Apparent power; Power consumption; Frequency; Cos phi		
Number of measurement inputs	6 (3 voltage measurement inputs; 3 current measurement inputs)		
Rated voltage	ULN = 277 VAC/VDC; ULL = 480 VAC		
Input resistance (voltage path) typ.	1071 kΩ		
Measuring current (max.)	1 A	5 A	
Input resistance (current path) typ.	22 mΩ	5 mΩ	
Resolution	16 bits		
Measuring error (max.) at 25 °C	AC current/voltage:		
	±0.5 % of the upper-range value	±0.6 % of the upper-range value	±0.5 % of the upper-range value
Frequency range (mains frequency)	45 ... 65 Hz		
Limit frequency	7.2 kHz		
Current consumption – system supply (5 V)	100 mA		
Data width	2 x 48-bit data; 2 x 24-bit control/status (optional)		
Isolation	4 kV (system/field)		
Surrounding air temperature (operation)	0 ... +55 °C	-20 ... +60 °C	0 ... +55 °C
Dimensions W x H x D	12 x 69.8 x 100 mm		
Approvals	CE, OrdLoc/HazLoc, ATEX/IECEx		
Data sheet and further information, see:	<a href="http://wago.com/750-493">wago.com/750-493</a>		
Accessories	Item No.		
Split-core and plug-in current transformers	See Full Line Catalog, Volume 4		

# Analog Input; for 3-Phase Power Measurement

5.4



Item Description				
Version				
Item No.				
Order Text				
3-Phase Power Measurement; 480 VAC 1 A				
Standard	Extended temperature	480 VAC, 5 A	480 VAC 5 A; Extended temperature	
750-494	750-494/025-000	750-494/000-001	750-494/025-001	
3-PHASE POM; 480VAC 1A	3-PHASE POM; 480VAC 1A; T	3-PHASE POM; 480VAC 5A	3-PHASE POM; 480VAC 5A; T	

Technical Data				
Signal type				
Measured variables				
Number of measurement inputs				
Rated voltage				
Input resistance (voltage path) typ.				
Measuring current (max.)				
Input resistance (current path) typ.				
Resolution				
Measuring error (max.) at 25 °C				
Frequency range (mains frequency)				
Frequency range (harmonics analysis)				
Limit frequency				
Current consumption – system supply (5 V)				
Data width				
Isolation				
Surrounding air temperature (operation)				
Dimensions W x H x D				
Approvals				
Data sheet and further information, see:				

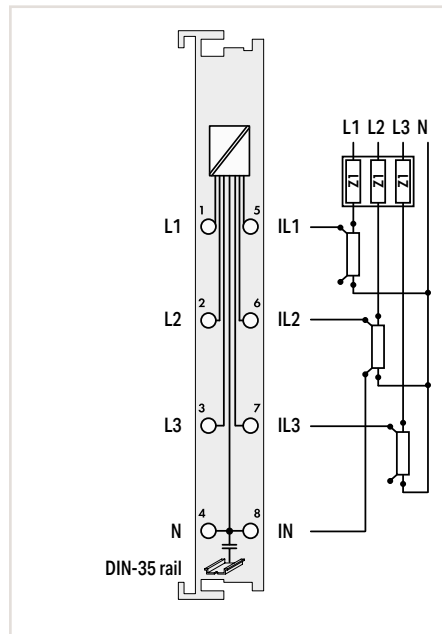
3-phase power measurement			
Voltage; Current; Effective power; Reactive power; Apparent power; Power consumption; Frequency; Cos phi; Harmonics (up to the 41st harmonic); THD and more			
6 (3 voltage measurement inputs; 3 current measurement inputs)			
ULN = 277 VAC/VDC; ULL = 480 VAC			
1072 kΩ			
1 A		5 A	
22 mΩ		5 mΩ	
24 bits			
AC current/voltage: ±0.5 % the upper-range value			
45 ... 65 Hz			
0 ... 3300 Hz			
15.9 kHz			
100 mA			
2 x 128-bit data; 2 x 64-bit control/status			
4 kV (system/field)			
0 ... +55 °C	-20 ... +60 °C	0 ... +55 °C	-20 ... +60 °C
12 x 69.8 x 100 mm			
CE; Marine; OrdLoc/HazLoc; ATEX/IECEX			
wago.com/750-494			

Accessories				
Split-core and plug-in current transformers				
Item No.				
See Full Line Catalog, Volume 4				

„ Mini-WSB marker card and mounting accessories, see Section "Accessories and Tools"

„ Approvals and corresponding ratings, see page 520 or www.wago.com

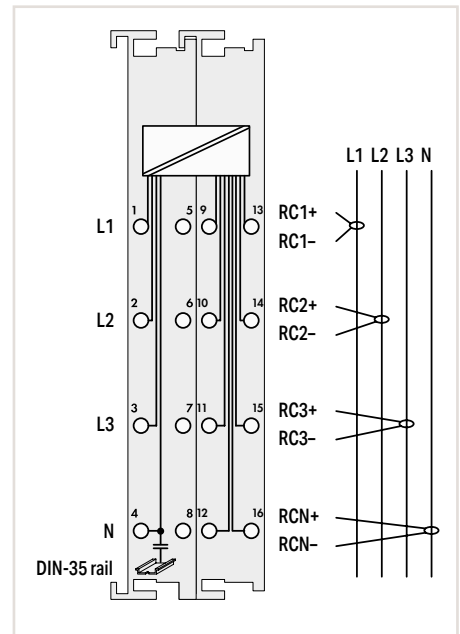
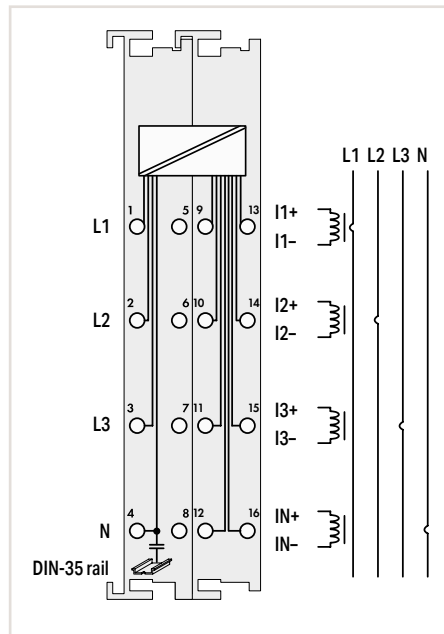
## Analog Input; for Power Measurement



<b>Item Description</b>	<b>Power Measurement</b>
<b>Version</b>	<b>277 VAC/DC; External shunts</b>
<b>Item No.</b>	<b>750-494/000-005</b>
<b>Order Text</b>	Power Measurement; 277 VAC/DC; External shunts
<b>Technical Data</b>	<b>Power Measurement</b>
Signal type	Line-to-line voltage; Power output; Energy; Power factors; Mains frequency; Harmonic analysis (up to the 41st harmonic); THD
Measured variables	6 (3 voltage measurement inputs*; 3 current measurement inputs*); *Only 2 voltage/current measurement inputs can be used for DC measurement!
Number of measurement inputs	U <sub>LN</sub> = 277 VAC/VDC; U <sub>LL</sub> = 480 VAC
Rated voltage	1072 kΩ
Input resistance (voltage path) typ.	1 ... 20,000 A via ext. shunts (DIN 43703, DIN EN 60051 [50 ... 300 mV])
Measuring current (max.)	Approx. 15 kΩ
Input resistance (current path) typ.	24 bits
Resolution	AC: 0.5 % (max.); DC: 1.0 % (of the upper-range value)
Measuring error for current and voltage	45 ... 65 Hz
Frequency range (mains frequency)	0 ... 3300 Hz
Frequency range (harmonics analysis)	15.9 kHz
Limit frequency	100 mA
Current consumption – system supply (5 V)	2 x 128-bit data; 2 x 64-bit control/status
Data width	4 kV (system/field)
Isolation	0 ... +55 °C
Surrounding air temperature (operation)	12 x 67.8 x 100 mm
Dimensions W x H x D	CE; Marine; OrdLoc/HazLoc; ATEX/IECEx
Approvals	<a href="http://wago.com/750-494/000-005">wago.com/750-494/000-005</a>
Data sheet and further information, see:	

## Analog Input; for 3-Phase Power Measurement

5.4



Item Description	3-Phase Power Measurement; 690 VAC 1 A		3-phase power measurement
Version	Standard		690 VAC 5 A
Item No.	750-495	750-495/000-001	750-495/000-002
Order Text	3-PHASE POM; 690VAC 1A	3-PHASE POM; 690VAC 5A	3-PHASE POM; 690VAC R.C.
<b>Technical Data</b>			
Signal type	3-phase power measurement		
Measured variables	Voltage; Current; Effective power; Reactive power; Apparent power; Power consumption; Frequency; Cos phi; Harmonics (up to the 41st harmonic); THD; Current measurement in N-conductor; and more		
Number of measurement inputs	7 (3 voltage measurement inputs; 4 differential current measurement inputs)		
Rated voltage	$U_{LN} = 400 \text{ VAC}; U_{LL} = 690 \text{ VAC}$		
Input resistance (voltage path) typ.	1429 k $\Omega$		
Measuring current (max.)	1 A	5 A	Rogowski coils
Input resistance (current path) typ.	22 m $\Omega$	5 m $\Omega$	44 k $\Omega$
Resolution	24 bits		
Measuring error (max.) at 25 °C	AC current/voltage: $\pm 0.5 \%$ of the upper-range value		
Frequency range (mains frequency)	45 ... 65 Hz		
Frequency range (harmonics analysis)	0 ... 3300 Hz		
Limit frequency	15.9 kHz		
Current consumption – system supply (5 V)	100 mA		
Data width	2 x 128-bit data; 2 x 64-bit control/status		
Isolation	6 kV (system/field)		
Surrounding air temperature (operation)	0 ... +55 °C		
Dimensions W x H x D	24 x 69.8 x 100 mm		
Approvals	CE,  Marine		
Data sheet and further information, see:	<a href="http://wago.com/750-495">wago.com/750-495</a>		
Accessories	Item No.	Item No.	Item No.
Split-core and plug-in current transformers	See Full Line Catalog, Volume 4		
Rogowski coils	See Full Line Catalog, Volume 4		

„ Mini-WSB marker card and mounting accessories, see Section "Accessories and Tools"

„ Approvals and corresponding ratings, see page 520 or [www.wago.com](http://www.wago.com)

5.4

# Analog Output Modules

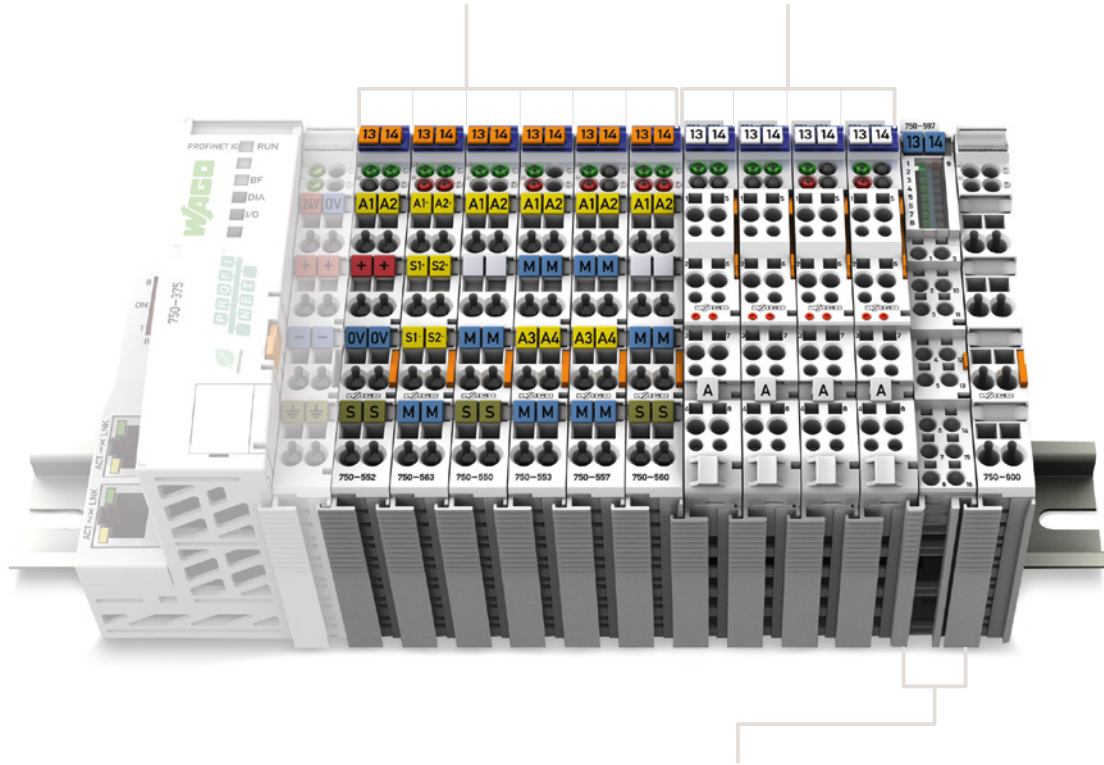


## Housing design (750 Series)

Dimensions W x H x D	12 x 69.8 x 100 mm
Height from upper-edge of DIN-rail	62.6 mm
Connection technology	CAGE CLAMP®
Conductor range	0.08 ... 2.5 mm <sup>2</sup> / 28 ... 14 AWG
Strip length	8 ... 9 mm / 0.33 inch

## Housing design (753 Series)

Dimensions W x H x D	12 x 69.8 x 100 mm
Height from upper-edge of DIN-rail	62.6 mm
Connection technology	CAGE CLAMP®
Conductor range	0.08 ... 2.5 mm <sup>2</sup> / 28 ... 14 AWG
Strip length	9 ... 10 mm / 0.37 inch



## Housing design (750 Series), with Push-in CAGE CLAMP® connections (up to 16 connection points)

Dimensions W x H x D	12 x 69 x 100 mm
Height from upper-edge of DIN-rail	61.8 mm
Connection technology	Push-in CAGE CLAMP®
Conductor range	Solid: 0.08 ... 1.5 mm <sup>2</sup> / 28 ... 16 AWG Fine-stranded: 0.25-1.5 mm <sup>2</sup> / 22-16 AWG;
Strip length	8 ... 9 mm / 0.33 inch



I/O System -  
750 XTR Series





## I/O System – 750 and 753 Series; Analog Output Modules

### Contents

Function	2-Channel AO	4-Channel AO	8-Channel AO	Description	Item Number				Page
					Standard	/S5 Customized Data Format	Extended Temperature	Pluggable	
0 ... 20 mA	■			2-Channel Analog Output; 0 ... 20 mA	750-552	750-552/000-200	750-552/025-000	753-552	248
		■		4-Channel Analog Output; 0 ... 20 mA	750-553			753-553	249
4 ... 20 mA	■			2-Channel Analog Output; 4 ... 20 mA	750-554	750-554/000-200	750-554/025-000	753-554	250
		■		4-Channel Analog Output; 4 ... 20 mA	750-555			753-555	251
0/4 ... 20 mA	■			2-Channel Analog Output; 0/4 ... 20 mA; 16 bits; 6 ... 18 VDC	750-563*				251
0 ... 10 V	■			2-Channel Analog Output; 0 ... 10 VDC	750-550	750-550/000-200		753-550	252
	■			2-Channel Analog Output; 0 ... 10 VDC; 10 bits; 100 mW/24 V	750-560				252
		■		4-Channel Analog Output; 0 ... 10 VDC	750-559*		750-559/025-000	753-559	253
±10 V	■			2-Channel Analog Output; ±10 VDC	750-556	750-556/000-200		753-556	254
		■		4-Channel Analog Output; ±10 VDC	750-557*			753-557	254
0 ... 10 V/±10 V	■			2-Channel Analog Output; 0 ... 10 VDC/±10 V; 16 bits	750-562				255
			■	8-Channel Analog Output; 0 ... 10 VDC/±10 V	750-597				255
Ex i					See Section 5.9				
*This module is also available as a 750 XTR Series variant.					See Section 6				

## Analog Output; 0 ... 20 mA



Figure: 750-552

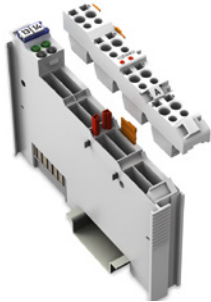
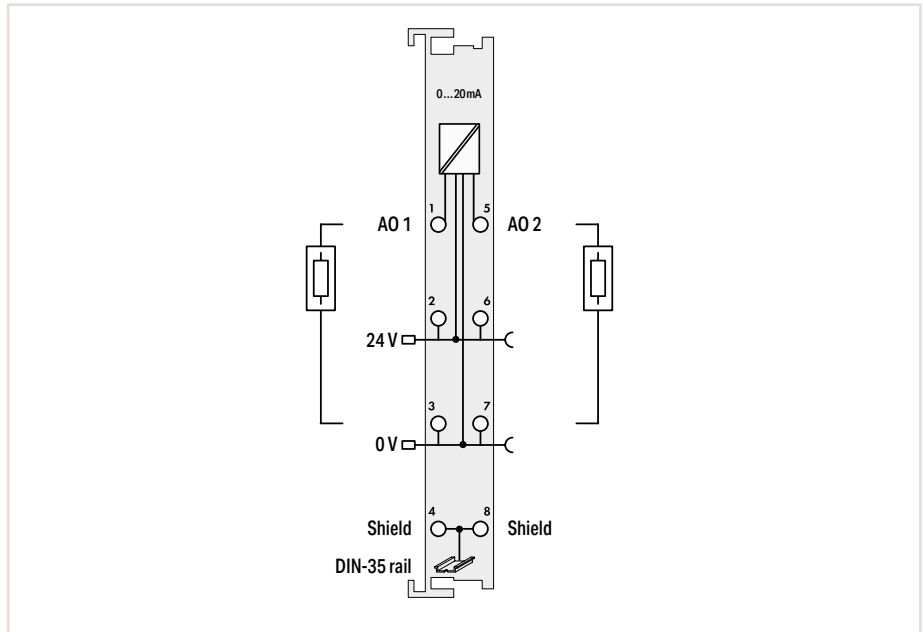


Figure: 753-552



Item Description	2-Channel Analog Output; 0 ... 20 mA			
Version	Standard	Extended temperature	Pluggable (delivery without connector)	Data Format (S5 Control)
Item No.	750-552	750-552/025-000	753-552	750-552/000-200
Order Text	2AO; 0-20mA	2AO; 0-20mA; T	2AO; 0-20mA	2AO; 0-20mA; S5

Technical Data	
Pluggable connector	•
Customized data format for S5 control*	•
Number of analog outputs	2
Signal type	0 ... 20 mA
Actuator connection	2-wire
Load impedance	< 600 Ω
Resolution	12 bits
Conversion time	Approx. 2 ms
Output error (max.) at 25 °C	±0.1 % of the upper-range value
Temperature error (max.)	±0.01 % of the upper-range value
Supply voltage (field)	24 VDC (-25 ... +30 %); via power jumper contacts (power supply via blade contact; transmission via spring contact)
Current consumption – system supply (5 V)	70 mA
Data width	2 x 16-bit data; 2 x 8-bit control/status (optional)
Isolation	500 V (system/field)
Surrounding air temperature (operation)	0 ... +55 °C      -20 ... +60 °C      0 ... +55 °C
Dimensions W x H x D	12 x 69.8 x 100 mm
Approvals	CE; Marine; OrdLoc/HazLoc; ATEX/IECEx
Data sheet and further information, see:	<a href="http://wago.com/750-552">wago.com/750-552</a> <a href="http://wago.com/753-552">wago.com/753-552</a> <a href="http://wago.com/750-552">wago.com/750-552</a>

Accessories	Item No.
Pluggable connector	753-110
Coding keys	753-150

\*The S5 format allows you to import data with the standard S5 FB 250 function block.

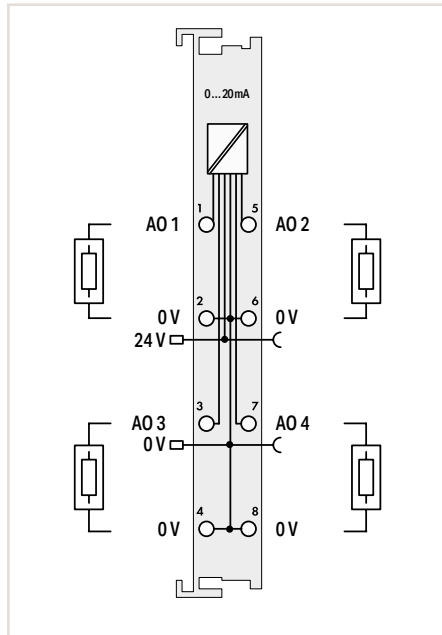
„ Mini-WSB marker card and mounting accessories, see Section "Accessories and Tools"  
 „ Approvals and corresponding ratings, see page 521 or [www.wago.com](http://www.wago.com)

## Analog Output; 0 ... 20 mA



Figure: 750-553

Figure: 753-553



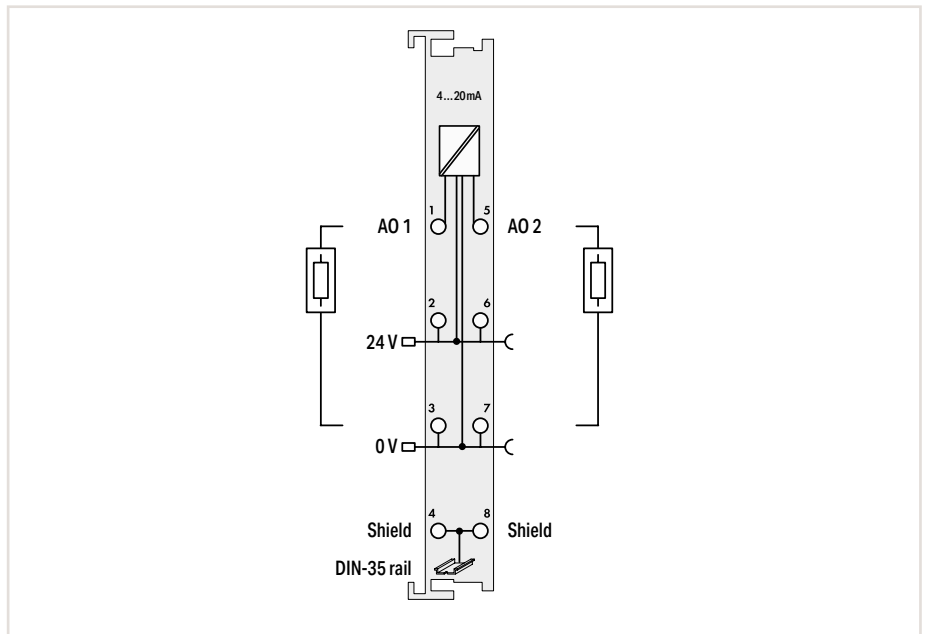
Item Description		4-Channel Analog Output; 0 ... 20 mA	
Version		Standard	Pluggable (delivery without connector)
Item No.	750-553	750-553	753-553
Order Text	4AO; 0-20mA	4AO; 0-20mA	4AO; 0-20mA
<b>Technical Data</b>			
Pluggable connector			●
Number of analog outputs			4
Signal type			0 ... 20 mA
Actuator connection			2-wire
Load impedance			Either 0 ... 300 Ω or 300 ... 600 Ω (same resistance for all load impedances)
Resolution			12 bits
Conversion time			10 ms
Output error (max.) at 25 °C			±0.1 % of the upper-range value
Temperature error (max.)			±0.01 % of the upper-range value
Supply voltage (field)			24 VDC (-25 ... +30 %); via power jumper contacts (power supply via blade contact; transmission via spring contact)
Current consumption – system supply (5 V)			60 mA
Data width			4 x 16-bit data; 4 x 8-bit control/status (optional)
Isolation			500 V (system/field)
Surrounding air temperature (operation)			0 ... +55 °C
Dimensions W x H x D			12 x 69.8 x 100 mm
Approvals			CE; Marine; OrdLoc/HazLoc; ATEX/IECEX
Data sheet and further information, see:		wago.com/750-553	wago.com/753-553
<b>Accessories</b>		<b>Item No.</b>	
Pluggable connector			753-110
Coding keys			753-150

## Analog Output; 4 ... 20 mA



Figure: 750-554

Figure: 753-554



Item Description		2-Channel Analog Output; 4 ... 20 mA			
Version		Standard	Extended temperature	Pluggable (delivery without connector)	Data format (S5 control)
Item No.		750-554	750-554/025-000	753-554	750-554/000-200
Order Text		2AO; 4-20mA	2AO; 4-20mA; T	2AO; 4-20mA	2AO; 4-20mA; S5
<b>Technical Data</b>					
Pluggable connector		•			
Customized data format for S5 control*		•			
Number of analog outputs		2			
Signal type		4 ... 20 mA			
Actuator connection		2-wire			
Load impedance		< 600 Ω			
Resolution		12 bits			
Conversion time		Approx. 2 ms			
Output error (max.) at 25 °C		±0.1 % of the upper-range value			
Temperature error (max.)		±0.015 %/K of the upper-range value			
Supply voltage (field)		24 VDC (-25 ... +30 %); via power jumper contacts (power supply via blade contact; transmission via spring contact)			
Current consumption – system supply (5 V)		70 mA			
Data width		2 x 16-bit data; 2 x 8-bit control/status (optional)			
Isolation		500 V (system/field)			
Surrounding air temperature (operation)		0 ... +55 °C	-20 ... +60 °C	0 ... +55 °C	
Dimensions W x H x D		12 x 69.8 x 100 mm			
<b>Approvals</b>					
CE;  Marine;  OrdLoc/HazLoc;  ATEX/IECEx					
Data sheet and further information, see:		<a href="http://wago.com/750-554">wago.com/750-554</a>	<a href="http://wago.com/753-554">wago.com/753-554</a>	<a href="http://wago.com/750-554">wago.com/750-554</a>	
<b>Accessories</b>				<b>Item No.</b>	
Pluggable connector				753-110	
Coding keys				753-150	

\*The S5 format allows you to import data with the standard S5 FB 250 function block.

„ Mini-WSB marker card and mounting accessories, see Section "Accessories and Tools"

„ Approvals and corresponding ratings, see page 521 or [www.wago.com](http://www.wago.com)

## Analog Output; 4 ... 20 mA or Configurable 0/4 ... 20 mA; 6 ... 18 VDC



Figure: 750-555

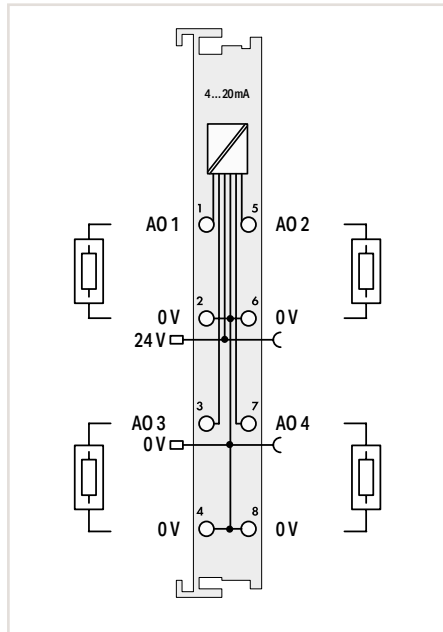
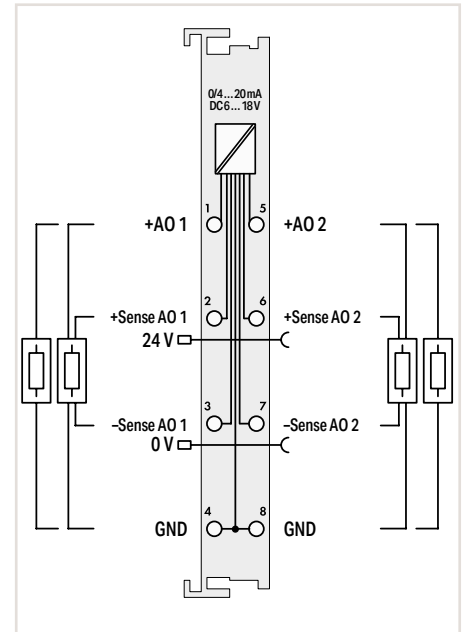


Figure: 753-555



5.5

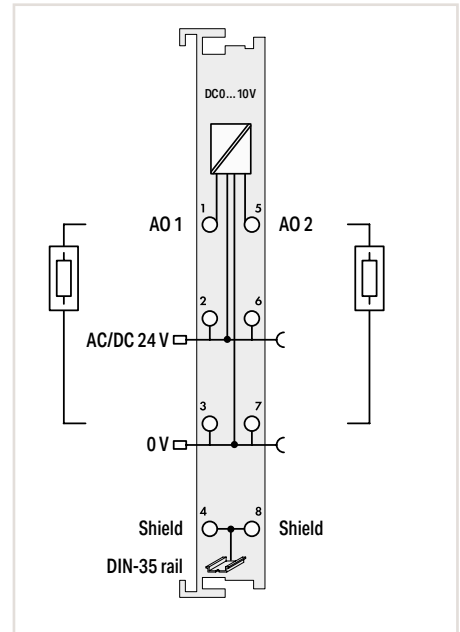
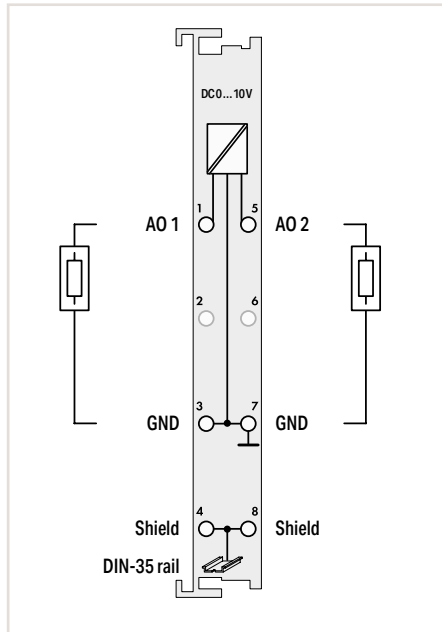
Item Description	4-Channel Analog Output; 4 ... 20 mA		2-Channel Analog Output; 0/4 ... 20 mA; 16 bits; 6 ... 18 VDC
Version	Standard	Pluggable (delivery without connector)	Standard
Item No.	750-555	753-555	750-563
Order Text	4AO; 4-20mA	4AO; 4-20mA	2AO; 0/4-20mA; 16bits; 6-18 VDC
<b>Technical Data</b>			
Pluggable connector		●	
Number of analog outputs	4		2
Signal type	4 ... 20 mA		0 ... 20 mA; 4 ... 20 mA; 6 ... 18 V
Actuator connection	2-wire		2-wire; 4-wire
Load impedance	Either 0 ... 300 Ω or 300 ... 600 Ω (same resistance for all load impedances)		> 1.8 kΩ (voltage output); < 500 Ω (current output)
Resolution	12 bits		16 bits
Conversion time	10 ms		5 ms
Output error (max.) at 25 °C	±0.1 % of the upper-range value		±0.05 % of the upper-range value
Temperature error (max.)	±0.01 % of the upper-range value		±100 ppm
Supply voltage (field)	24 VDC (-25 ... +30 %); via power jumper contacts (power supply via blade contact; transmission via spring contact)		24 VDC (-15 ... +20 %); via power jumper contacts (power supply via blade contact; transmission via spring contact)
Current consumption – system supply (5 V)	60 mA		80 ... 110 mA
Data width	4 x 16-bit data; 4 x 8-bit control/status (optional)		2 x 16-bit data; 2 x 8-bit control/status (optional)
Isolation	500 V (system/field)		500 V (system/field)
Surrounding air temperature (operation)	0 ... +55 °C		0 ... +55 °C
Dimensions W x H x D	12 x 69.8 x 100 mm		12 x 69.8 x 100 mm
Approvals	CE; Marine; OrdLoc/HazLoc; ATEX/IECEX		CE; Marine; OrdLoc/HazLoc; ATEX/IECEX
Data sheet and further information, see:	<a href="http://wago.com/750-555">wago.com/750-555</a>	<a href="http://wago.com/753-555">wago.com/753-555</a>	<a href="http://wago.com/750-563">wago.com/750-563</a>
<b>Accessories</b>			
Pluggable connector		Item No.	753-110
Coding keys			753-150

## Analog Output; 0 ... 10 VDC



Figure: 750-550

Figure: 753-550



Item Description	2-Channel Analog Output; 0 ... 10 VDC			2-Channel Analog Output; 0 ... 10 VDC; 10 bits; 100 mW/24 V
Version	Standard			Standard
Item No.	750-550	750-550/000-200	753-550	750-560
Order Text	2AO; 0-10 VDC	2AO; 0-10 VDC; S5	2AO; 0-10 VDC	2AO; 0-10 VDC; 10Bit; 100mW/ 24V
<b>Technical Data</b>				
Pluggable connector			•	
Customized data format for S5 control*		•		
Number of analog outputs	2			2
Signal type	0 ... 10 V			0 ... 10 V
Actuator connection	2-wire			2-wire
Load impedance	> 5 kΩ			≥ 1 kΩ
Resolution	12 bits			10 bits
Conversion time	Approx. 2 ms			Approx. 10 ms
Output error (max.) at 25 °C	±0.1 % of the upper-range value			±0.2 % of the upper-range value
Temperature error (max.)	±0.01 % of the upper-range value			±0.02 % of the upper-range value
Supply voltage (field)				24 V AC/DC; via power jumper contacts (power supply via blade contact; transmission via spring contact)
Current consumption – system supply (5 V)	65 mA			16 mA
Data width	2 x 16-bit data; 2 x 8-bit control/status (optional)			2 x 16-bit data; 2 x 8-bit control/status (optional)
Isolation	500 V (system/field)			500 V (system/field)
Surrounding air temperature (operation)	0 ... +55 °C			0 ... +55 °C
Dimensions W x H x D	12 x 69.8 x 100 mm			12 x 69.8 x 100 mm
Approvals	CE;  Marine;  OrdLoc/HazLoc;  ATEX/IECEx			CE;  OrdLoc/HazLoc;  ATEX/IECEx
Data sheet and further information, see:	<a href="http://wago.com/750-550">wago.com/750-550</a>		<a href="http://wago.com/753-550">wago.com/753-550</a>	<a href="http://wago.com/750-560">wago.com/750-560</a>
<b>Accessories</b>				
Pluggable connector				Item No. 753-110
Coding keys				753-150

\*The S5 format allows you to import data with the standard S5 FB 250 function block.

„ Mini-WSB marker card and mounting accessories, see Section "Accessories and Tools"

„ Approvals and corresponding ratings, see page 521 or [www.wago.com](http://www.wago.com)

## Analog Output; 0 ... 10 VDC



Figure: 750-559

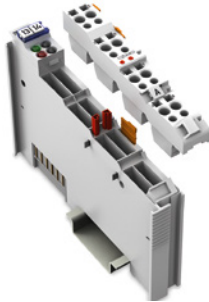
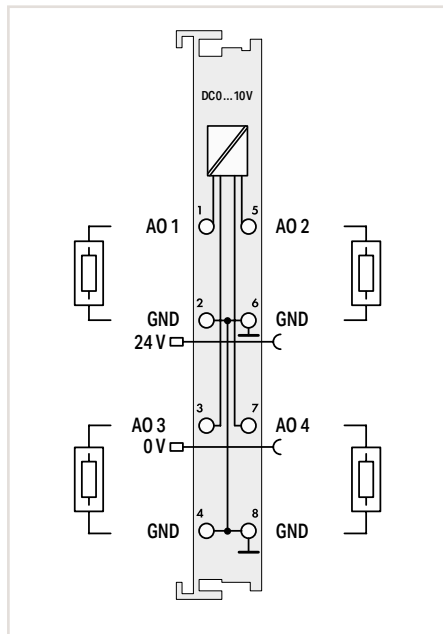


Figure: 753-559



Item Description		4-Channel Analog Output; 0 ... 10 VDC		
Version		Standard	Extended temperature	Pluggable (delivery without connector)
Item No.		750-559	750-559/025-000	753-559
Order Text		4AO; 0-10 VDC	4AO; 0-10 VDC; T	4AO; 0-10 VDC
<b>Technical Data</b>				
Pluggable connector		●		
Number of analog outputs		4		
Signal type		0 ... 10 V		
Actuator connection		2-wire		
Load impedance		> 5 kΩ		
Resolution		12 bits		
Conversion time		10 ms		
Output error (max.) at 25 °C		±0.1 % of the upper-range value		
Temperature error (max.)		±0.01 % of the upper-range value		
Supply voltage (field)		24 VDC (-25 ... +30 %); via power jumper contacts (power supply via blade contact; transmission via spring contact)		
Current consumption – system supply (5 V)		125 mA		
Data width		4 x 16-bit data; 4 x 8-bit control/status (optional)		
Isolation		500 V (system/field)		
Surrounding air temperature (operation)		0 ... +55 °C	-20 ... +60 °C	0 ... +55 °C
Dimensions W x H x D		12 x 69.8 x 100 mm		
Approvals		CE;  Marine;  OrdLoc/HazLoc; ATEX/IECEX		
Data sheet and further information, see:		<a href="http://wago.com/750-559">wago.com/750-559</a>		<a href="http://wago.com/753-559">wago.com/753-559</a>
<b>Accessories</b>		<b>Item No.</b>		
Pluggable connector		753-110		
Coding keys		753-150		

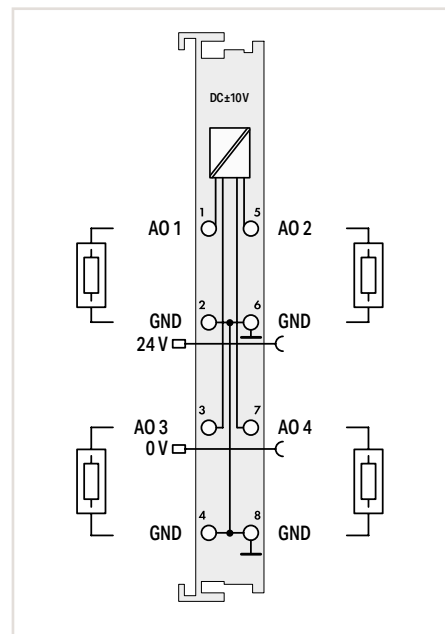
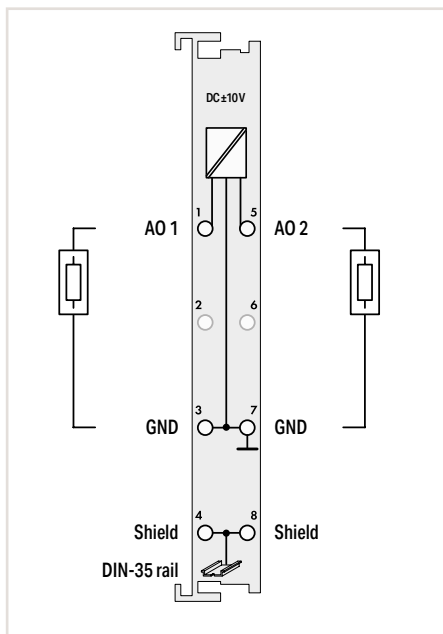
## Analog Output; ±10 VDC

5.5



Figure: 750-556

Figure: 753-556



Item Description	2-Channel Analog Output; ±10 VDC			4-Channel Analog Output; ±10 VDC	
Version	Standard	Data format (S5 control)	Pluggable (delivery without connector)	Standard	Pluggable (delivery without connector)
Item No.	750-556	750-556/000-200	753-556	750-557	753-557
Order Text	2AO; ±10 VDC	2AO; ±10 VDC; S5	2AO; ±10 VDC	4AO; ±10 VDC	4AO; ±10 VDC
<b>Technical Data</b>					
Pluggable connector			•		•
Customized data format for S5 control*		•			•
Number of analog outputs	2			4	
Signal type	±10 V			±10 V	
Actuator connection	2-wire			2-wire	
Load impedance	> 5 kΩ			> 5 kΩ	
Resolution	12 bits			12 bits	
Conversion time	Approx. 2 ms			10 ms	
Output error (max.) at 25 °C	±0.1 % of the upper-range value			±0.1 % of the upper-range value	
Temperature error (max.)	±0.01 % of the upper-range value			±0.01 % of the upper-range value	
Supply voltage (field)				24 VDC (-25 ... +30 %); via power jumper contacts (power supply via blade contact; transmission via spring contact)	
Current consumption – system supply (5 V)	65 mA			125 mA	
Data width	2 x 16-bit data; 2 x 8-bit control/status (optional)			4 x 16-bit data; 4 x 8-bit control/status (optional)	
Isolation	500 V (system/field)			500 V (system/field)	
Surrounding air temperature (operation)	0 ... +55 °C			0 ... +55 °C	
Dimensions W x H x D	12 x 69.8 x 100 mm			12 x 69.8 x 100 mm	
Approvals	CE;  Marine;  OrdLoc/HazLoc;  ATEX/IECEx			CE;  Marine;  OrdLoc/HazLoc;  ATEX/IECEx	
Data sheet and further information, see:	<a href="http://wago.com/750-556">wago.com/750-556</a>		<a href="http://wago.com/753-556">wago.com/753-556</a>	<a href="http://wago.com/750-557">wago.com/750-557</a>   <a href="http://wago.com/753-557">wago.com/753-557</a>	
<b>Accessories</b>					
Pluggable connector				Item No. 753-110	
Coding keys				Item No. 753-150	

\*The S5 format allows you to import data with the standard S5 FB 250 function block.

„ Mini-WSB marker card and mounting accessories, see Section "Accessories and Tools"

„ Approvals and corresponding ratings, see page 521 or [www.wago.com](http://www.wago.com)



## Analog Output; Configurable 0 ... 10 VDC; ±10 V



Figure: 750-562

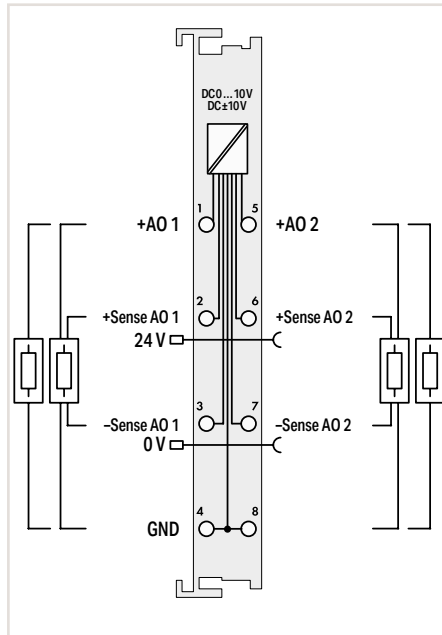
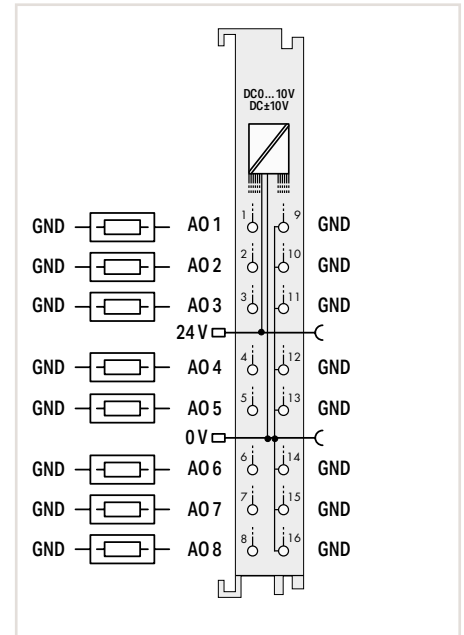


Figure: 750-597



<b>Item Description</b>
<b>Version</b>
<b>Item No.</b>
<b>Order Text</b>

<b>2-Channel Analog Output; 0 ... 10 VDC/±10 V; 16 bits</b>
<b>Standard</b>
<b>750-562</b>
<b>2AO; 0-10 V/±10 VDC; 16bits</b>

<b>8-Channel Analog Output; 0 ... 10 VDC/±10 V</b>
<b>Standard with 16 connectors</b>
<b>750-597</b>
<b>8AO; 0-10 V/±10 VDC</b>

Technical Data	
Number of analog outputs	2
Signal type	0 ... 10 V; ±10 V
Actuator connection	2-wire; 4-wire
Load impedance	> 5 kΩ
Resolution	16 bits
Conversion time	5 ms
Output error (max.) at 25 °C	±0.05 % of the upper-range value
Temperature error (max.)	±100 ppm
Supply voltage (field)	24 VDC (-15 ... +20 %); via power jumper contacts (power supply via blade contact; transmission via spring contact)
Current consumption – system supply (5 V)	80 ... 170 mA
Data width	2 x 16-bit data; 2 x 8-bit control/status (optional)
Isolation	500 V (system/field)
Surrounding air temperature (operation)	0 ... +55 °C
Dimensions W x H x D	12 x 69.8 x 100 mm
<b>Approvals</b>	CE, UL, OrdLoc/HazLoc, ATEX/IECEX
<b>Data sheet and further information, see:</b>	<a href="http://wago.com/750-562">wago.com/750-562</a>

Number of analog outputs	8
Signal type	0 ... 10 V; ±10 V
Actuator connection	2-wire
Load impedance	≥ 2 kΩ
Resolution	12 bits
Conversion time	13 ms
Output error (max.) at 25 °C	±0.1 % of the upper-range value
Temperature error (max.)	±10 ppm/K of the upper-range value
Supply voltage (field)	24 VDC (-15 ... +30 %); via power jumper contacts (power supply via blade contact; transmission via spring contact)
Current consumption – system supply (5 V)	61 mA
Data width	8 x 16-bit data; 8 x 8-bit control/status (optional)
Isolation	500 V (system/field)
Surrounding air temperature (operation)	0 ... +55 °C
Dimensions W x H x D	12 x 69 x 100 mm
<b>Approvals</b>	CE, UL
<b>Data sheet and further information, see:</b>	<a href="http://wago.com/750-597">wago.com/750-597</a>

Number of analog outputs	8
Signal type	0 ... 10 V; ±10 V
Actuator connection	2-wire
Load impedance	≥ 2 kΩ
Resolution	12 bits
Conversion time	13 ms
Output error (max.) at 25 °C	±0.1 % of the upper-range value
Temperature error (max.)	±10 ppm/K of the upper-range value
Supply voltage (field)	24 VDC (-15 ... +30 %); via power jumper contacts (power supply via blade contact; transmission via spring contact)
Current consumption – system supply (5 V)	61 mA
Data width	8 x 16-bit data; 8 x 8-bit control/status (optional)
Isolation	500 V (system/field)
Surrounding air temperature (operation)	0 ... +55 °C
Dimensions W x H x D	12 x 69 x 100 mm
<b>Approvals</b>	CE, UL
<b>Data sheet and further information, see:</b>	<a href="http://wago.com/750-597">wago.com/750-597</a>

# Function/Technology Modules



## Housing design (750 Series)

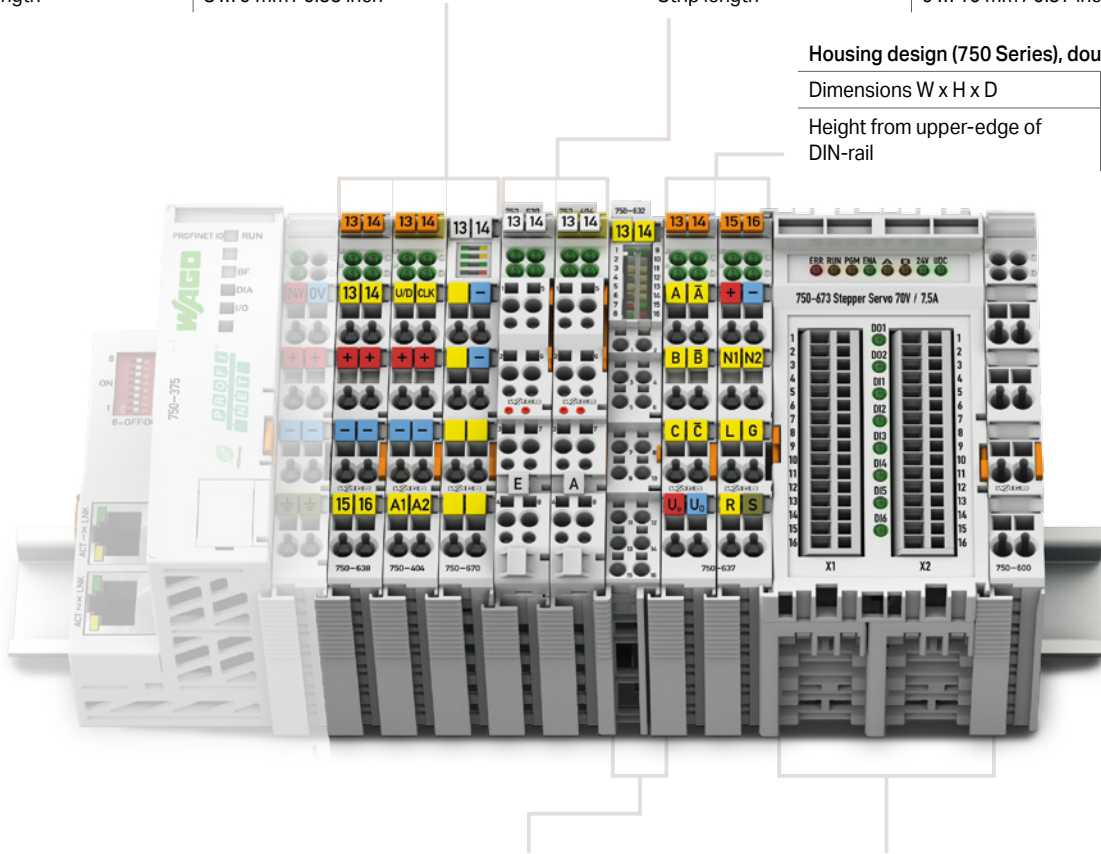
Dimensions W x H x D	Housing with 4 LEDs: 12 x 69.8 x 100 mm Housing with 8 LEDs: 12 x 67.8 x 100 mm
Height from upper-edge of DIN-rail	Housing with 4 LEDs: 62.6 mm Housing with 8 LEDs: 60.6 mm
Connection technology	CAGE CLAMP®
Conductor cross section	0.08 ... 2.5 mm <sup>2</sup> / 28 ... 14 AWG
Strip length	8 ... 9 mm / 0.33 inch

## Housing design (753 Series)

Dimensions W x H x D	Housing with 4 LEDs: 12 x 69.8 x 100 mm Housing with 8 LEDs: 12 x 69 x 100 mm
Height from upper-edge of DIN-rail	Housing with 4 LEDs: 62.6 mm Housing with 8 LEDs: 61.8 mm
Connection technology	CAGE CLAMP®
Conductor cross section	0.08 ... 2.5 mm <sup>2</sup> / 28 ... 14 AWG
Strip length	9 ... 10 mm / 0.37 inch

## Housing design (750 Series), double width

Dimensions W x H x D	24 x 69.8 x 100 mm
Height from upper-edge of DIN-rail	62.6 mm



## Housing design (750 Series), with Push-in CAGE CLAMP® connections (up to 16 connection points)

Dimensions W x H x D	12 x 69 x 100 mm
Height from upper-edge of DIN-rail	61.8 mm
Connection technology	Push-in CAGE CLAMP®
Conductor cross section	Solid: 0.08 ... 1.5 mm <sup>2</sup> / 28 ... 16 AWG Fine-stranded: 0.25-1.5 mm <sup>2</sup> / 22-16 AWG;
Strip length	8 ... 9 mm / 0.33 inch

## Specialty housing

Dimensions W x H x D	51 x 69.8 x 100 mm
Height from upper-edge of DIN-rail	62.6 mm
Connection technology	CAGE CLAMP®
Conductor cross section	0.08 ... 1.5 mm <sup>2</sup> / 28 ... 14 AWG
Strip length	5 ... 6 mm / 0.22 in



I/O System –  
750 XTR Series



## I/O System – 750 and 753 Series; Function/Technology Modules

### Contents

Function	Description	Item Number			Page
		Standard	Extended Temperature	Pluggable	
Counter Modules	Up/Down Counter	750-404*		753-404	258
	Up Counter; Release input	750-404/000-001			258
	Peak-Time Counter	750-404/000-002			258
	Frequency Counter	750-404/000-003		753-404/000-003	259
	Up/Down Counter; Switch output	750-404/000-004			258
	2 Up Counters; 16 bits	750-404/000-005		753-404/000-005	259
	2 Up/Down Counters; 16 bits; 500 Hz	750-638	750-638/025-000	753-638	260
Pulse Width Outputs	2 Pulse Width Outputs; 24 VDC; 0.1 A; 250 kHz	750-511		753-511	261
	2 Pulse Width Outputs; 24 VDC; 0.1 A; 2 kHz; Frequency counter	750-511/000-001			261
	2 Pulse Width Outputs; 24 VDC; 0.1 A; 100 Hz	750-511/000-002			261
Distance and Angle Measurement	SSI Transmitter Interface; 24 bits; 125 kHz; Gray code	750-630			262
	SSI Transmitter Interface; 24 bits; 125 kHz; Bin. code	750-630/000-001			263
	SSI Transmitter Interface; 24 bits; 250 kHz; Bin. code	750-630/000-002			263
	SSI Transmitter Interface; 24 bits; 125 kHz; Gray code; Status byte	750-630/000-004			262
	SSI Transmitter Interface; 15 bits; 125 kHz; Gray code; Status byte	750-630/000-005			262
	SSI Transmitter Interface; 24 bits; 250 kHz; Gray code	750-630/000-006			263
	SSI Transmitter Interface; 25 bits; 125 kHz; Gray code	750-630/000-008			263
	SSI Transmitter Interface; 13 bits; 250 kHz; Bin. code	750-630/000-009			263
	SSI Transmitter Interface; 25 bits; 125 kHz; Bin. code	750-630/000-011			263
	SSI Transmitter Interface; 13 bits; 125 kHz; Gray code	750-630/000-012			263
	SSI Transmitter Interface; 29 bits; 125 kHz; Bin. code	750-630/000-013			263
	SSI Transmitter Interface; Adjustable	750-630/003-000*			262
	Incremental Encoder Interface; RS-422; 16 bits	750-631/000-004			264
	Incremental Encoder Interface; RS-422; 32 bits	750-637			264
	Incremental Encoder Interface; 24 VDC; Differential input; 32 bits	750-637/000-001*			265
	Incremental Encoder Interface; 24 VDC; Single-ended; 32 bits	750-637/000-002			265
	Incremental Encoder Interface; 5 VDC; 32 bits; Single evaluation	750-637/000-003			265
	Incremental Encoder Interface; 24 VDC; Single-ended; 32 bits; Cam output	750-637/000-004			265
	Digital Impulse Interface	750-635		753-635	266
	RTC Module	Real-Time Clock Module	750-640		
Vibration Monitoring	2-Channel Vibration Velocity/Bearing Condition Monitoring VIB I/O Module	750-645			268
Stepper Modules	Stepper Controller; RS-422/24 VDC; 20 mA	750-670			269
	Stepper Controller; 24 VDC; 1.5 A	750-671			270
	Stepper Controller; 70 VDC; 7.5 A	750-672			271
	Servo Stepper Controller; 55 VDC; 7.5 A	750-673			272
DC Drive Controllers	DC Drive Controller; 24 VDC; 5 A	750-636	750-636/025-000		273
	DC Drive Controller; 24 VDC; 5 A; External motor voltage	750-636/000-700			273
	DC Drive Controller; 24 VDC; 5 A; Interference-free	750-636/000-800			273
Proportional Valve Module	Proportional Valve Module	750-632			274
<b>Ex i</b>					See Section 5.9
*This module is also available as a 750 XTR Series variant.					See Section 6

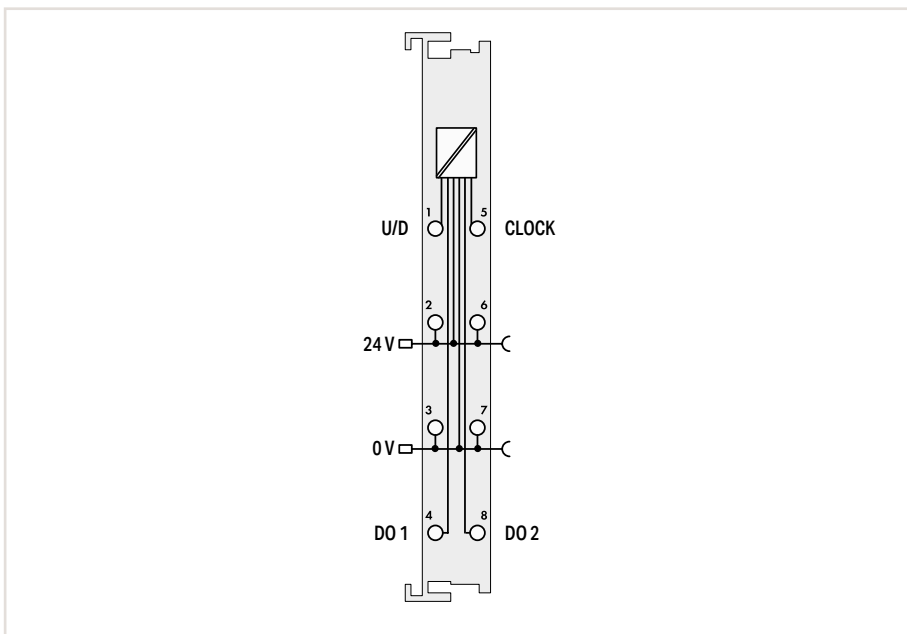
## Up/Down Counter; 100 kHz



Figure: 750-404



Figure: 753-404



5.6

Item Description		Up/Down Counter				
Version		Standard	Switch output	Pluggable (delivery without connector)	Up counter; Release input	Peak-time counter
Item No.		750-404	750-404/000-004	753-404	750-404/000-001	750-404/000-002
Order Text		Up/Down Counter	Up/Down Counter; Switch Output	Up/Down Counter	Up Counter; Release Input	Peak Time Counter

Technical Data	
Pluggable connector	•
Number of outputs	2
Number of counters	1
Voltage range for signal (0)	-3 ... +5 VDC
Voltage range for signal (1)	15 ... 30 VDC
Output current	0.5 A; short-circuit-protected
Switching frequency (max.)	100 kHz
Pulse width (min.)	10 kHz
Input current (typ.)	6 mA
Counter depth	32 bits
Supply voltage (field)	5 ... 14 VDC (-15 ... +20 %); via power jumper contacts (power supply via blade contact; transmission via spring contact)
Current consumption – system supply (5 V)	70 mA
Data width (internal)	32-bit data; 8-bit control/status
Isolation	500 V (system/field)
Surrounding air temperature (operation)	0 ... +55 °C
Dimensions W x H x D	12 x 69.8 x 100 mm
Approvals	CE; Marine; OrdLoc/HazLoc; ATEX/IECEX
Data sheet and further information, see:	<a href="http://wago.com/750-404">wago.com/750-404</a>   <a href="http://wago.com/753-404">wago.com/753-404</a>   <a href="http://wago.com/750-404">wago.com/750-404</a>

Accessories	Item No.
Pluggable connector	753-110
Coding keys	753-150

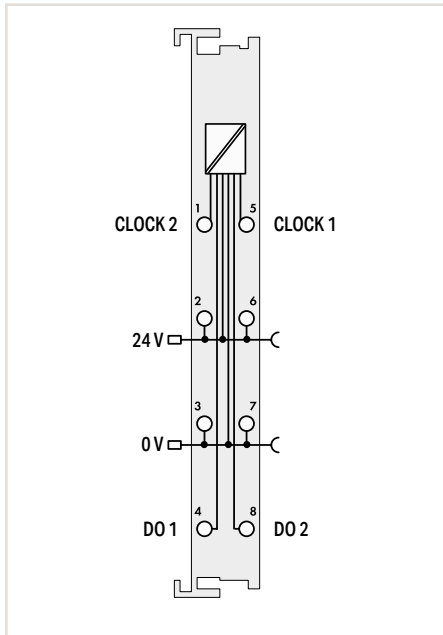
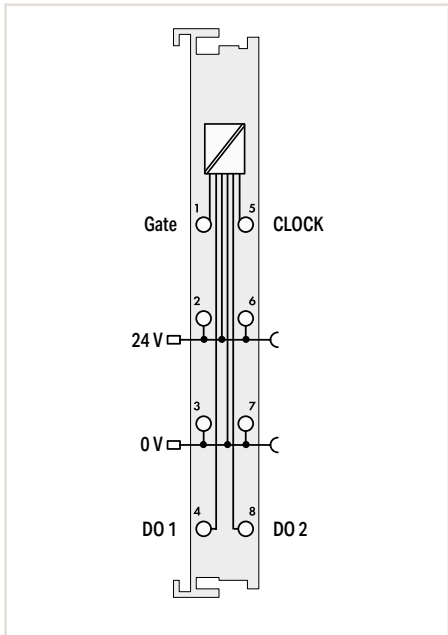
Up/down counter: When the U/D input is switched with +24 V, the counting direction is upward. When an input is not switched or is 0 V, the counting direction is downward.

Up counter: The counting is locked when the GATE input is open or 0 V is present. Counting is enabled with +24 V at the GATE input.

Peak-time counter: The count pulses at the CLOCK input are recorded over a pre-set period of 10 seconds.

„ Mini-WSB marker card and mounting accessories, see Section "Accessories and Tools"

„ Approvals and corresponding ratings, see page 522 or www.wago.com



Frequency Counter	
Standard	Pluggable (delivery without connector)
750-404/000-003	753-404/000-003
Frequency Counter; 100kHz	Frequency Counter; 100kHz

2 Up Counters; 16 bits	
Standard	Pluggable (delivery without connector)
750-404/000-005	753-404/000-005
2Up Counter; 16bits	2Up Counter; 16bits

	●
2	
1	
-3 ... +5 VDC	
15 ... 30 VDC	
0.5 A; short-circuit-protected	
100 kHz	
10 µs	
5 mA	
32 bits	
5 ... 14 VDC (-15 ... +20 %); via power jumper contacts (power supply via blade contact; transmission via spring contact)	
70 mA	
32-bit data; 8-bit control/status	
500 V (system/field)	
0 ... +55 °C	
12 x 69.8 x 100 mm	
CE;  Marine;  OrdLoc/HazLoc;  ATEX/IECEX	
wago.com/ 750-404/000-003	wago.com/ 753-404/000-003

	●
2	
2	
-3 ... +5 VDC	
15 ... 30 VDC	
0.5 A; short-circuit-protected	
5 kHz (pulse width > 100 µs)	
5 mA	
2 x 16-bit data	
5 ... 14 VDC (-15 ... +20 %); via power jumper contacts (power supply via blade contact; transmission via spring contact)	
70 mA	
32-bit data; 8-bit control/status	
500 V (system/field)	
0 ... +55 °C	
12 x 69.8 x 100 mm	
CE;  Marine;  OrdLoc/HazLoc;  ATEX/IECEX	
wago.com/ 750-404/000-005	wago.com/ 753-404/000-005

Item No.
753-110
753-150

Item No.
753-110
753-150

The frequency counter measures the 24 V signal pulse period at the CLOCK input and converts it to a frequency value. The measurement is enabled when the GATE input is open or 0 V is present. Measurement is disabled when 24 V are present at the GATE input.

This module is equipped with two 16-bit up counters. The count pulses are recorded at the CLOCK 1 and CLOCK 2 inputs.

## 2 Up/Down Counters; 16 bits; 500 Hz



Figure: 750-638

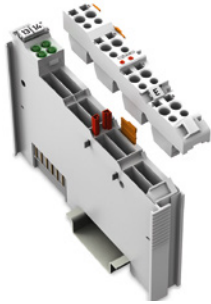
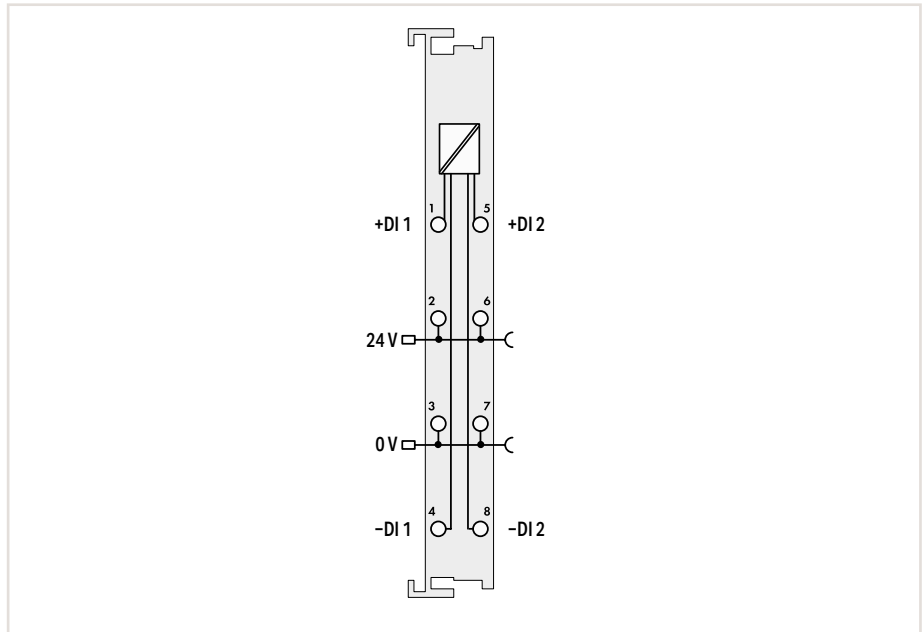


Figure: 753-638



5.6

Item Description			
Version			
Item No.	Standard		Extended temperature
750-638	750-638		750-638/025-000
Order Text	2Up/Down Counter; 16bits; 500Hz		2Up/Down Counter; 16bits; 500Hz; T
			Pluggable (delivery without connector)
			753-638
			2Up/Down Counter; 16bits; 500Hz

Technical Data			
Pluggable connector			
Number of outputs	2		
Number of counters	2		
Voltage range for signal (0)	-3 ... +5 VDC		
Voltage range for signal (1)	15 ... 30 VDC		
Switching frequency (max.)	500 Hz		
Pulse width (min.)	1 ms		
Counter depth	16 bits		
Supply voltage (field)	5 ... 14 VDC (-15 ... +20 %); via power jumper contacts (power supply via blade contact; transmission via spring contact)		
Current consumption – system supply (5 V)	10 mA		
Data width (internal)	2 x 16-bit data; 2 x 8-bit control/status		
Isolation	500 V (system/field)		
Surrounding air temperature (operation)	0 ... +55 °C	-20 ... +60 °C	0 ... +55 °C
Dimensions W x H x D	12 x 69.8 x 100 mm		
Approvals	CE;  OrdLoc/HazLoc;  ATEX/IECEx		
Data sheet and further information, see:	<a href="http://wago.com/750-638">wago.com/750-638</a>		<a href="http://wago.com/753-638">wago.com/753-638</a>

Accessories		Item No.
Pluggable connector		753-110
Coding keys		753-150

„ Mini-WSB marker card and mounting accessories, see Section "Accessories and Tools"  
 „ Approvals and corresponding ratings, see page 522 or www.wago.com

## Pulse Width Output



Figure: 750-511

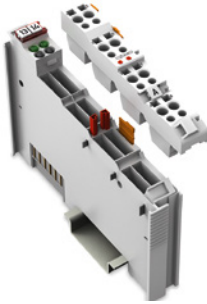
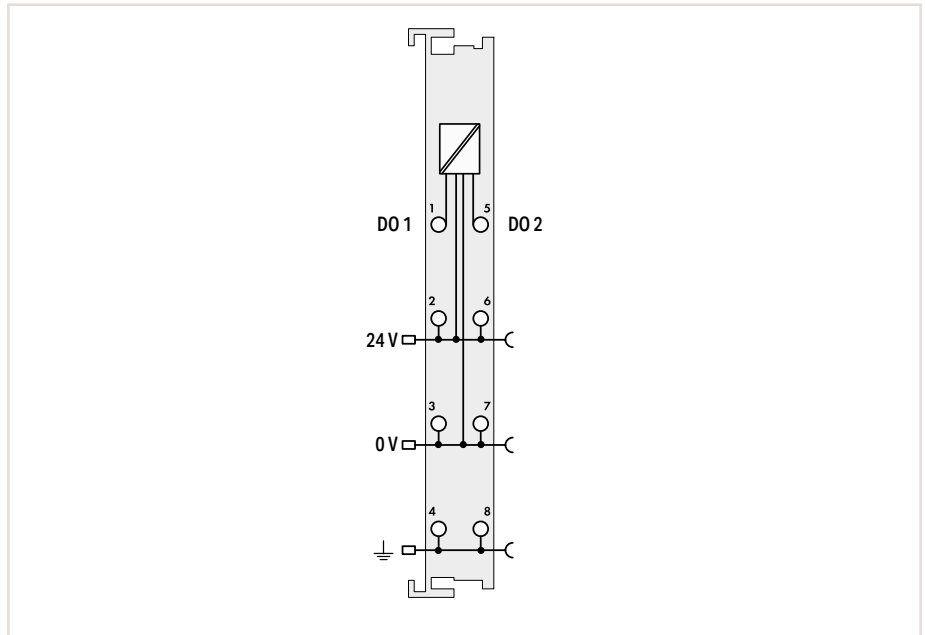


Figure: 753-511



5.6

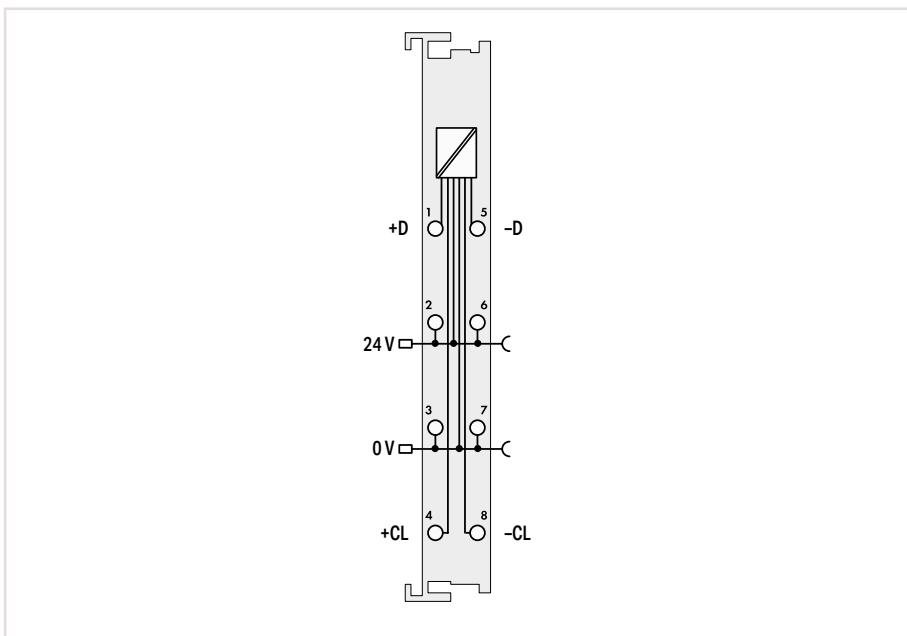
Item Description	2 Pulse Width Outputs; 24 VDC; 0.1 A; 250 Hz			
Version	Standard	Pluggable (delivery without connector)	2 kHz; Frequency counter	100 Hz
Item No.	750-511	753-511	750-511/000-001	750-511/000-002
Order Text	2PWM; 24 VDC; 0.1A; 250Hz	2PWM; 24 VDC; 0.1A; 250Hz	2PWM; 24 VDC; 0.1A; 2kHz; Frequency Counter	2PWM; 24 VDC; 0.1A; 100Hz

Technical Data				
Pluggable connector	●			
Number of outputs	2			
Load type	Resistive; inductive			
Pulse frequency	250 Hz	2 Hz ... 2 kHz		100 Hz
Duty cycle	0 ... 100 %	50 %		0 ... 100 %
Output current	0.1 A; short-circuit-protected			
Resolution	10 bits			
Supply voltage (field)	5 ... 14 VDC (-15 ... +20 %); via power jumper contacts (power supply via blade contact; transmission via spring contact)			
Current consumption – system supply (5 V)	70 mA			
Data width (internal)	2 x 16-bit data; 2 x 8-bit control/status			
Isolation	500 V (system/field)			
Surrounding air temperature (operation)	0 ... +55 °C			
Dimensions W x H x D	12 x 69.8 x 100 mm			
Approvals	CE;  OrdLoc/HazLoc;  ATEX/IECEx			
Data sheet and further information, see:	<a href="http://wago.com/750-511">wago.com/750-511</a>	<a href="http://wago.com/753-511">wago.com/753-511</a>	<a href="http://wago.com/750-511/000-001">wago.com/750-511/000-001</a>	<a href="http://wago.com/750-511/000-002">wago.com/750-511/000-002</a>
Accessories				
Pluggable connector	Item No. 753-110			
Coding keys	753-150			

## SSI Transmitter Interface



Figure: 750-630



5.6

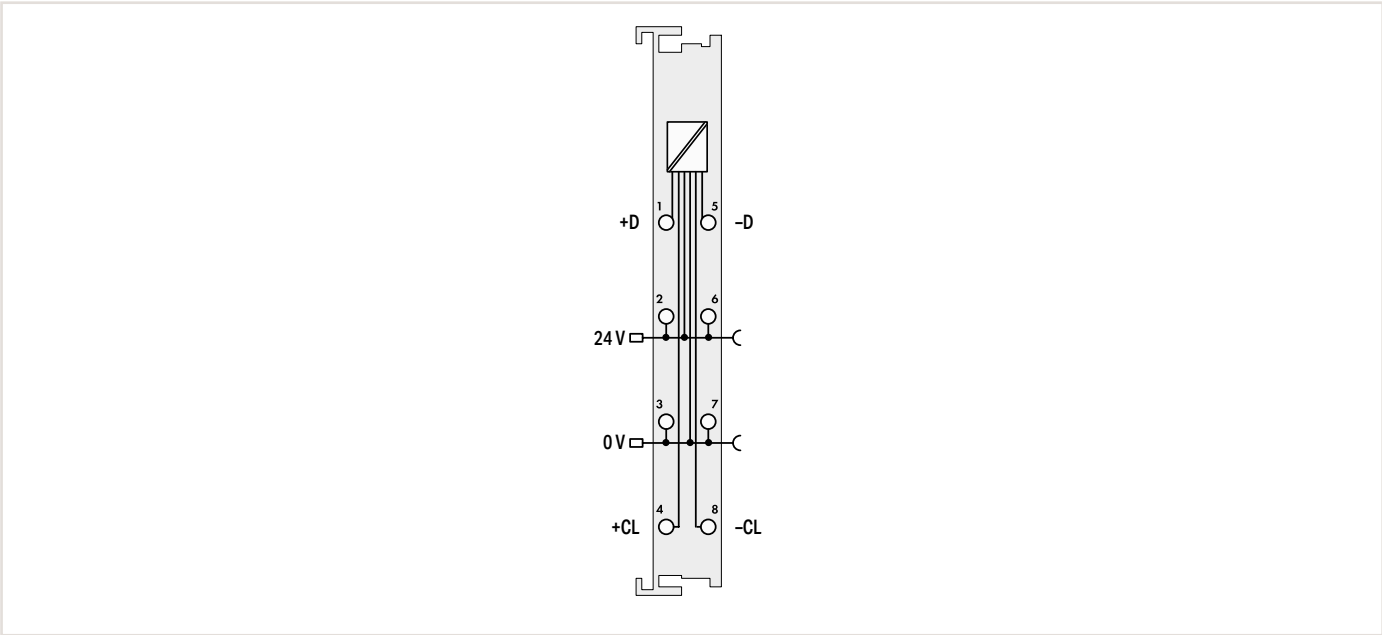
Item Description		SSI Transmitter Interface		
Version	Adjustable	24 Bits; 125 kHz; Gray Code	24 Bits; 125 kHz; Gray Code; Status Byte	15 Bits; 125 kHz; Gray Code; Status Byte
Item No.	750-630/003-000	750-630	750-630/000-004	750-630/000-005
Order Text	SSI Interface; adjust	SSI Interface; 24bits; 125kHz; Gray	SSI Interface; 24bits; 125kHz; Gray; Status	SSI Interface; 15bits; 125kHz; Gray; Status

Technical Data	
Encoder connection	On + D; - D; Off + CL; - CL
Encoder supply	24 VDC; via power jumper contacts
Transmission rate	62.5 ... 250 kHz      125 kHz
Serial input	Data width: 1 ... 32 bits      Data width: 24 bits      Data width: 15 bits
Signal output	Differential signal (RS-422)
Signal input	Differential signal (RS-422)
Code	Gray code/binary code      Gray code
Supply voltage (field)	5 ... 14 VDC (-15 ... +20 %); via power jumper contacts (power supply via blade contact; transmission via spring contact)
Current consumption – system supply (5 V)	20 mA
Data width (internal)	1 x 32 bits      1 x 32-bit; 1 x 8-bit control/status (optional)
Isolation	500 V (system/field)
Surrounding air temperature (operation)	0 ... +55 °C
Dimensions W x H x D	12 x 69.8 x 100 mm
Approvals	CE; Marine; OrdLoc/HazLoc; ATEX/IECEX
Data sheet and further information, see:	<a href="http://wago.com/750-630">wago.com/750-630</a>

„ Mini-WSB marker card and mounting accessories, see Section "Accessories and Tools"

„ Approvals and corresponding ratings, see page 522 or [www.wago.com](http://www.wago.com)





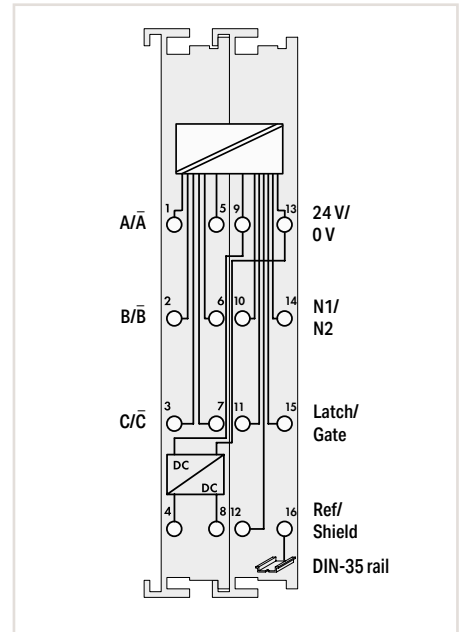
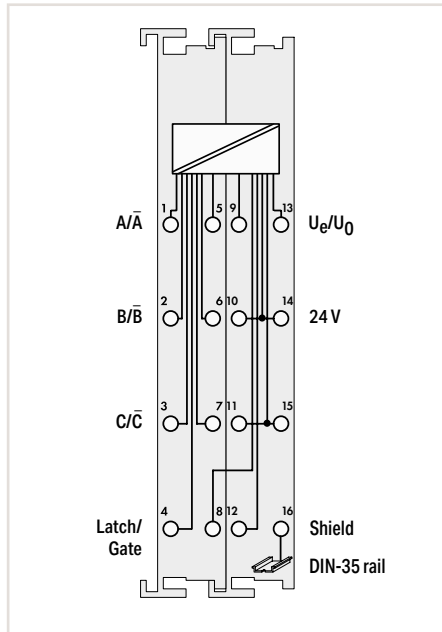
SSI Transmitter Interface							
24 Bits; 250 kHz; Gray Code	25 Bits; 125 kHz; Gray Code	13 Bits; 125 kHz; Gray Code	24 Bits; 125 kHz; Bin. Code	25 Bits; 125 kHz; Bin. Code	29 Bits; 125 kHz; Bin. Code	24 Bits; 250 kHz; Bin. Code	13 Bits; 250 kHz; Bin. Code
750-630/000-006	750-630/000-008	750-630/000-012	750-630/000-001	750-630/000-011	750-630/000-013	750-630/000-002	750-630/000-009
SSI Interface; 24bits; 250kHz; Gray	SSI Interface; 25bits; 125kHz; Gray	SSI Interface; 13bits; 125kHz; Gray	SSI Interface; 24bits; 125kHz; Bin	SSI Interface; 25bits; 125kHz; Bin	SSI Interface; 29bits; 125kHz; Bin	SSI Interface; 24bits; 250kHz; Bin	SSI Interface; 13bits; 250kHz; Bin

On + D; - D; Off + CL; - CL							
24 VDC; via power jumper contacts							
250 kHz	125 kHz				250 kHz		
Data width: 24 bits	Data width: 25 bits	Data width: 13 bits	Data width: 24 bits	Data width: 25 bits	Data width: 29 bits	Data width: 24 bits	Data width: 13 bits
Differential signal (RS-422)							
Differential signal (RS-422)							
Gray code				Binary code			
5 ... 14 VDC (-15 ... +20 %); via power jumper contacts (power supply via blade contact; transmission via spring contact)							
20 mA							
1 x 32 bits							
500 V (system/field)							
0 ... +55 °C							
12 x 69.8 x 100 mm							
CE;  Marine;  OrdLoc/HazLoc;  ATEX/IECEx							
<a href="http://wago.com/750-630">wago.com/750-630</a>							

## Incremental Encoder Interface



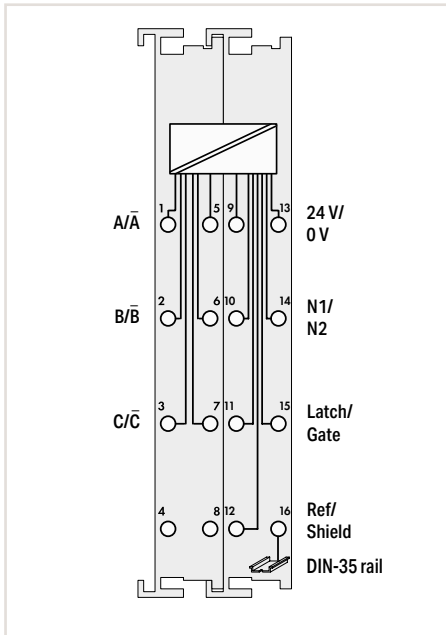
Figure: 750-631/000-004



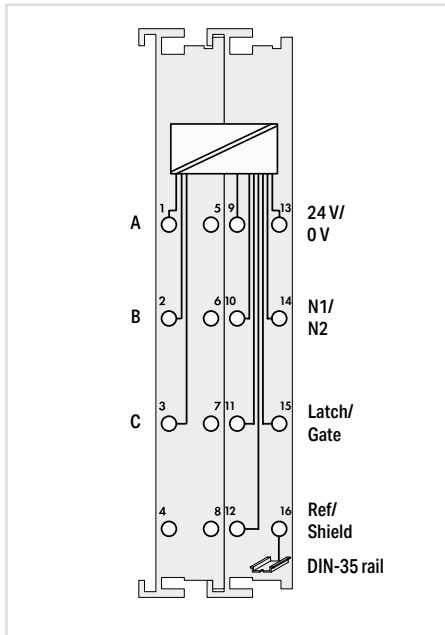
5.6

Item Description	Incremental Encoder Interface; RS-422; 16 bits		Incremental Encoder Interface; RS-422; 32 bits	
Version	Standard		Standard	
Item No.	750-631/000-004		750-637	750-637/000-003
Order Text	Inc. Encoder; RS422; 16bits		Inc. Encoder; RS422; 32bits	Inc. Encoder; RS422; 32bits
Technical Data				
Encoder connection	A; /A; B; /B; C; /C (RS-422 inputs)		A; /A; B; /B; C; /C (RS-422 inputs)	
Counter Modules	16 bits (binary)		32 bits (binary)	
Limit frequency	1000 kHz		250 kHz	
Quadrature decoder	4x evaluation		4x evaluation	1x evaluation
Zero impulse latch	16 bits		32 bits	
Commands	Reading; setting; activating		Reading; setting; activating	
Current consumption (typ.)	10 mA; without encoder		35 mA; without encoder	
Encoder operating voltage	5 VDC		5 VDC	
Encoder output current (max.)	200 mA		300 mA	
Output voltage			24 VDC	
Output current (max.)			0.5 A; short-circuit-protected	
Voltage range for signal (0)	U <sub>ABC</sub> = 0 V; U <sub>ABC/</sub> = 5 V; Latch, gate ≤ 5.0 V; External error U ≥ 5.0 V or open input		U <sub>ABC</sub> = RS-422; Latch, Gate, Ref.: -3 ... +5 VDC	
Voltage range for signal (1)	U <sub>ABC</sub> = 5 V; U <sub>ABC/</sub> = 0 V; Latch, gate ≥ 15.0 V; External error U < 0.5 V		U <sub>ABC</sub> = RS-422; Latch, Gate, Ref.: 15 ... 30 VDC	
Input current (typ.)			Latch 5 mA; Gate 7 mA; Ref. 7 mA	
Current consumption – system supply (5 V)	50 mA		110 mA	
Data width (internal)	2-byte output; 5-byte input 2x 8-bit control/status (optional) 3 additional output bytes (reserved)		1 x 32-bit data; 2 x 8-bit control/status	
Isolation	500 V (system/field)		500 V (system/field)	
Surrounding air temperature (operation)	0 ... +55 °C		0 ... +55 °C	
Dimensions W x H x D	24 x 69.8 x 100 mm		24 x 69.8 x 100 mm	
Approvals	CE; IEC; OrdLoc/HazLoc		CE; IEC; Marine; OrdLoc/HazLoc; ATEX/IECEX	
Data sheet and further information, see:	wago.com/750-631/000-004		wago.com/750-637	

„ Mini-WSB marker card and mounting accessories, see Section "Accessories and Tools"  
 „ Approvals and corresponding ratings, see page 522 or www.wago.com



**Incremental Encoder Interface; 24 VDC; Differential input; 32 bits**  
**Standard**  
 750-637/000-001  
 Inc. Encoder; 24 VDC; Diff; 32bits



**Incremental Encoder Interface; 24 VDC; Single-ended; 32 bits**  
**Standard**  
 750-637/000-002  
 Inc. Encoder; 24 VDC; SE; 32bits

Cam output
750-637/000-004
Inc. Encoder; 24 VDC; SE; 32bits; Cam

A; /A; B; /B; C; /C (differential inputs)
32 bits (binary)
250 kHz
4x evaluation
32 bits
Reading; setting; activating
35 mA; without encoder
24 VDC
300 mA
24 VDC
0.5 A; short-circuit-protected
(U <sub>ABC</sub> - U <sub>ABC/</sub> ): -30 ... +15 VDC; Latch, Gate, Ref.: -3 ... +5 VDC
(U <sub>ABC</sub> - U <sub>ABC</sub> ): 15 ... 30 VDC; Latch, Gate, Ref.: 15 ... 30 VDC
Latch 5 mA; Gate 7 mA; Ref. 7 mA
110 mA
1 x 32-bit data; 2 x 8-bit control/status
500 V (system/field)
0 ... +55 °C
24 x 69.8 x 100 mm
CE; Marine; OrdLoc/HazLoc; ATEX/IECEX
wago.com/750-637

A; B; C (single-ended inputs)
32 bits (binary)
250 kHz
4x evaluation
32 bits
Reading; setting; activating
35 mA; without encoder
24 VDC
300 mA
24 VDC
0.5 A; short-circuit-protected
-3 ... +5 VDC
15 ... 30 VDC
Latch 5 mA; Gate 7 mA; Ref. 7 mA
110 mA
1 x 32-bit data; 2 x 8-bit control/status
500 V (system/field)
0 ... +55 °C
24 x 69.8 x 100 mm
CE; Marine; OrdLoc/HazLoc; ATEX/IECEX
wago.com/750-637

## Digital Impulse Interface



Figure: 750-635

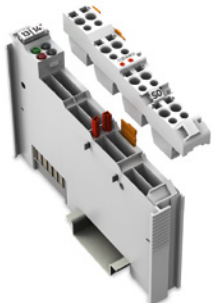
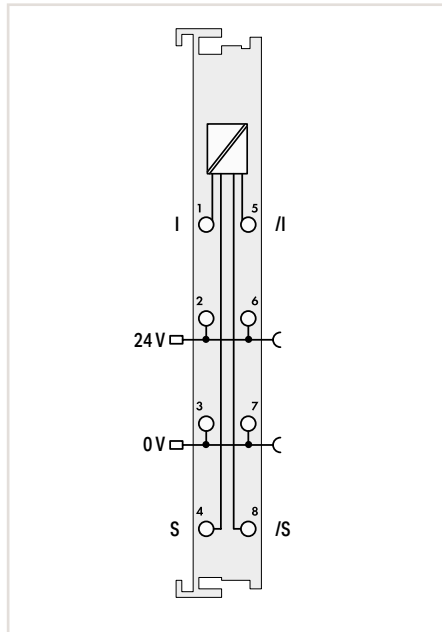


Figure: 753-635



5.6

Item Description
Version
Item No.
Order Text

Digital Impulse Interface	
Standard	Pluggable (delivery without connector)
750-635	753-635
Digital impulse interface	Digital impulse interface

Technical Data	
Pluggable connector	
Encoder connection	
Number of inputs	
Data transmission	
Signal output	
Signal input	
Resolution	
Update time	
Position sensor length	
Line length (max.)	
Supply voltage (field)	
Current consumption – system supply (5 V)	
Data width (internal)	
Isolation	
Surrounding air temperature (operation)	
Dimensions W x H x D	
Approvals	
Data sheet and further information, see:	

	•
Start/stop; Initialization; U <sub>i</sub> ; Ground; Shield connection via encoder housing	
1	
RS-422	
Differential signal (RS-422)	
Differential signal (RS-422)	
1 µm	
2 ms	
≤ 4 m	
500 m	
24 VDC (-15 % ... +20 %); via power jumper contacts (power supply via blade contact; transmission via spring contact)	
45 mA	
1 x 24-bit data; 1 x 8-bit control/status	
500 V (system/field)	
0 ... +55 °C	
12 x 69.8 x 100 mm	
CE; ;  OrdLoc/HazLoc;  ATEX/IECEX	
<a href="http://wago.com/750-635">wago.com/750-635</a>	<a href="http://wago.com/753-635">wago.com/753-635</a>

This digital impulse interface connects position sensors equipped with a start/stop interface. After receiving a read pulse, these sensors deliver a time-delayed reply impulse. The time delay is proportional to the sensor distance. Each sensor may have up to four position transmitters (permanent magnets). Their position data can be accessed serially by the control and are stored in the process image of the fieldbus coupler as a 24-bit value. Position sensors, from manufacturers such as Balluff, with the following features can be used:

- Start/stop interface with RS-422 differential signals
- 24 V sensor supply

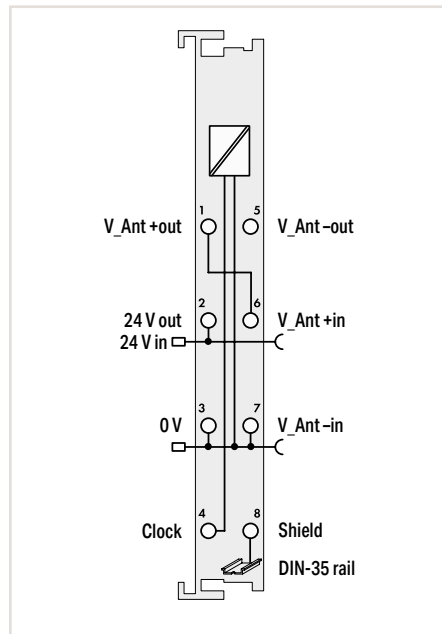
Accessories	
Pluggable connector	
Coding keys	

Item No.
753-110
753-150

„ Mini-WSB marker card and mounting accessories, see Section "Accessories and Tools"

„ Approvals and corresponding ratings, see page 522 or [www.wago.com](http://www.wago.com)

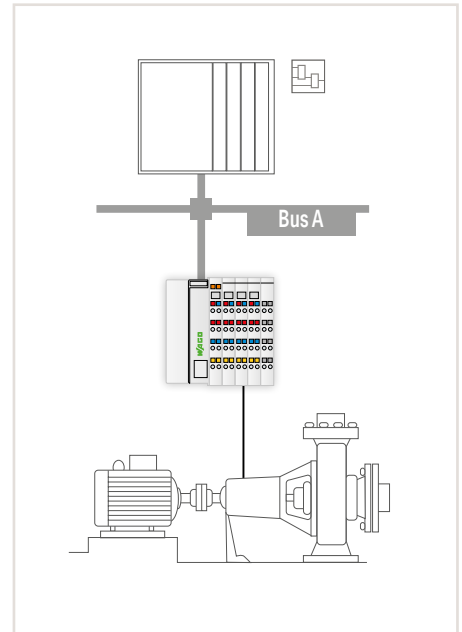
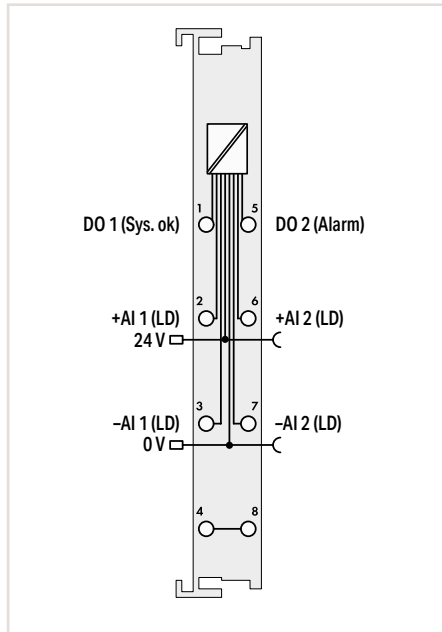
## Real-Time Clock Module



<b>Item Description</b>	Real-Time Clock Module
<b>Version</b>	Standard
<b>Item No.</b>	750-640
<b>Order Text</b>	RTC Module
<b>Technical Data</b>	
Drift (clock)	< 2 min./year
Buffer length	> 6 days
Timer	32 channels and switch points (32 x on/off)
Voltage range for signal (0)	-24 ... +1 V
Voltage range for signal (1)	3 ... 24 V
Input filter	10 ms
Supply voltage (field)	5 ... 14 VDC (-15 ... +20 %); via power jumper contacts (power supply via blade contact; transmission via spring contact)
Current consumption – system supply (5 V)	20 mA
Data width (internal)	1 x 40-bit data (input/output); (5-byte user data); 1 x 8-bit control/status (optional)
Isolation	500 V (system/field)
Surrounding air temperature (operation)	0 ... +55 °C
Dimensions W x H x D	12 x 69.8 x 100 mm
<b>Approvals</b>	CE, UL, OrdLoc/HazLoc, ATEX/IECEX
<b>Data sheet and further information, see:</b>	<a href="http://wago.com/750-640">wago.com/750-640</a>

This RTC module provides higher-level control systems with the actual time. The time is buffered and continues to run in the event of a power failure. When an external receiver is connected, the clock can be set using the time signal from DCF77, WWVB, or MSF. By default, the module is set to receive DCF77 signals. The receiver can be supplied directly via the module. Connecting an external receiver to operate the RTC module is not absolutely necessary.

## 2-Channel Vibration Velocity/Bearing Condition Monitoring VIB I/O Module



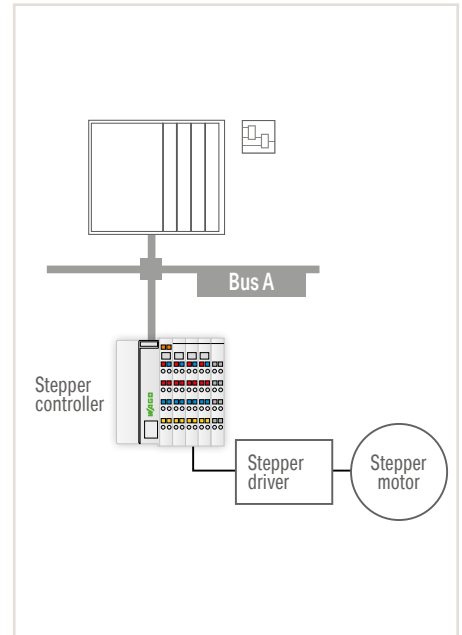
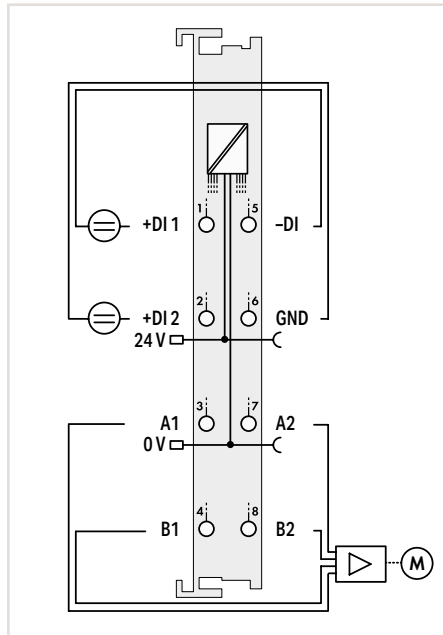
5.6

<b>Item Description</b>	<b>2-Channel Vibration Velocity/Bearing Condition Monitoring VIB I/O Module</b>
<b>Version</b>	<b>Standard</b>
<b>Item No.</b>	<b>750-645</b>
<b>Order Text</b>	<b>2VIB VRMS/SPM Multi</b>
<b>Technical Data</b>	
Encoder inputs	+AI1; -AI1; +AI2; -AI2
Number of inputs	2
Oscillating velocity (RMS)	0 ... 100 mm/s
Shock impulse (SPM)	-10 ... +80 dbSV
Number of outputs	2 (alarm and system OK)
Configuration	Both alarm and warning threshold can be set via process image and engineering software.
Outputs	24 VDC; 0.5 A; short-circuit protected
Supply voltage (field)	24 VDC (-15 % ... +20 %); via power jumper contacts (power supply via blade contact; transmission via spring contact)
Current consumption – system supply (5 V)	30 mA
Isolation	500 V (system/field)
Surrounding air temperature (operation)	0 ... +55 °C
Dimensions W x H x D	12 x 67.8 x 100 mm
<b>Approvals</b>	CE; UL; OrdLoc/HazLoc; ATEX/IECEX
<b>Data sheet and further information, see:</b>	<a href="http://wago.com/750-645">wago.com/750-645</a>
<b>Accessories</b>	<b>Item No.</b>
Tandem-piezo acceleration sensor	750-925

This module is used for online monitoring of machine vibration levels. It records the two key parameters required for condition monitoring: vibration velocity and bearing condition. Vibration velocity is a measurement for machines' energy and therefore, a suitable indicator for the vibration forces acting on the machine. Bearing condition is evaluated on the basis of high-frequency shock impulse signals. Shock impulses are momentary impulses arising from mechanical damage to roller bearings or the bearing surfaces. By recording the measurement results and evaluation in a trend curve, bearing damage can be detected at an early stage. A special Tandem-Piezo® acceleration sensor serves as encoder to facilitate simultaneous measurement of machine vibrations and high-frequency shock impulse signals.

„ Mini-WSB marker card and mounting accessories, see Section "Accessories and Tools"  
 „ Approvals and corresponding ratings, see page 522 or [www.wago.com](http://www.wago.com)

## Stepper Controller



<b>Item Description</b>	<b>Stepper Controller; RS-422/24 VDC; 20 mA</b>
<b>Version</b>	<b>Standard</b>
<b>Item No.</b>	<b>750-670</b>
<b>Order Text</b>	Stepper Controller; RS422/24 VDC; 20mA
<b>Technical Data</b>	
Number of outputs	1 channel (2 differential outputs A1; A2; B1; B2)
Signal voltage	5 VDC (internal); 5 ... 24 VDC (external)
Load type	RS-422; TTL; Optocoupler
Output current (max.)	30 mA; short-circuit-protected
Output frequency	200 µHz ... 500 kHz
Number of inputs	2 x 24 VDC
Voltage range for signal (0)	-3 ... +5 VDC
Voltage range for signal (1)	15 ... 30 VDC
Input filter	100 µs; software filter can be connected
Resolution	Path: 23 bits + sign bit; Speed: 15 bits + 16-bit prescaler; Acceleration: 15 bits + 16-bit- prescaler
Supply voltage (field)	24 VDC (-25 ... +30 %); via power jumper contacts (power supply via blade contact; transmission via spring contact)
Current consumption – system supply (5 V)	98 mA
Data width (internal)	12-byte input/output
Isolation	500 V (system/field)
Surrounding air temperature (operation)	0 ... +55 °C
Dimensions W x H x D	12 x 67.8 x 100 mm
<b>Approvals</b>	CE;  OrdLoc/HazLoc;  ATEX/IECEX
<b>Data sheet and further information, see:</b>	<a href="http://wago.com/750-670">wago.com/750-670</a>

This stepper controller is used to control different drive power sections with pulse/direction interface or incremental encoder input.

The 64-fold microstepping prevents step losses due to resonance in the acceleration phases and reduces wear on the mechanical parts. Adjustable current limits for stop, acceleration and constant speed help minimize motor power dissipation. Two configurable inputs for Start/Stop, limit switches, reference cams, Jog/Tip, etc., are evaluated directly and without any further delay by the internal software.

Versatile functions, such as positioning with different acceleration slopes, command tables, camshaft controller, auto referencing and other event-dependent properties provide this controller with a wide spectrum of possible uses.

Operating modes:

- Step positioning
- Reference motion
- Jog
- Tip
- Command table
- Cam switch

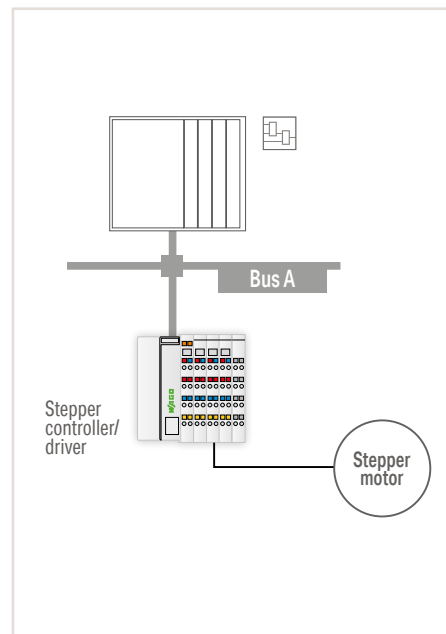
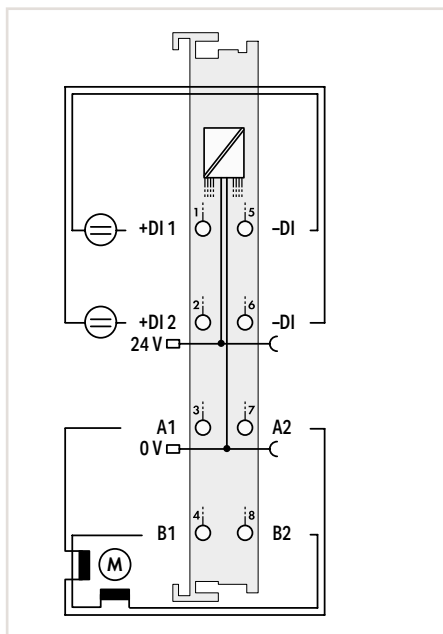
Functions include:

- Absolute/relative positioning
- Setpoint change on the fly
- Rotary axis

Additional operating modes:

- Pulse width modulation
- Frequency generator
- Single-shot mode

## Stepper Controller



### Item Description

### Version

### Item No.

### Order Text

### Technical Data

#### Number of outputs

Output current (max.)

Output frequency

Number of inputs

Voltage range for signal (0)

Voltage range for signal (1)

Input filter

Resolution

Supply voltage (field)

Current consumption – system supply (5 V)

Data width (internal)

Isolation

Surrounding air temperature (operation)

Dimensions W x H x D

### Approvals

Data sheet and further information, see:

Stepper Controller; 24 VDC; 1.5 A

Standard

750-671

Stepper Controller; 24 VDC; 1.5A

1 stepper motor (2-phase/bipolar)

Up to 2 x 1.5 A peak value; 1 A rms

7812 Hz

2 x 24 VDC

-3 ... +5 VDC

15 ... 30 VDC

100 µs; software filter can be connected

Path: 23 bits + sign bit; Speed: 15 bits + 16-bit prescaler; Acceleration: 15 bits + 16-bit-prescaler  
24 VDC (-25 ... +30 %); via power jumper contacts (power supply via blade contact; transmission via spring contact)

85 mA

12-byte input/output

500 V (system/field)

0 ... +55 °C

12 x 67.8 x 100 mm

CE, ATEX/IECEX

[wago.com/750-671](http://wago.com/750-671)

This stepper controller has an on-board power driver designed to control 2-phase stepper motors up to 24 V/1.5 A.

The 64-fold microstepping prevents step losses due to resonance in the acceleration phases and reduces wear on the mechanical parts. Adjustable current limits for stop, acceleration and constant speed help minimize motor power dissipation. Two configurable inputs for Start/Stop, limit switches, reference cams, Jog/Tip, etc., are evaluated directly and without any further delay by the internal software.

Versatile functions, such as positioning with different acceleration slopes, command tables, camshaft controller, auto referencing and other event-dependent properties provide this controller with a wide spectrum of possible uses.

Operating modes:

- Step positioning
- Reference motion
- Jog
- Tip
- Command table
- Cam switch

Functions include:

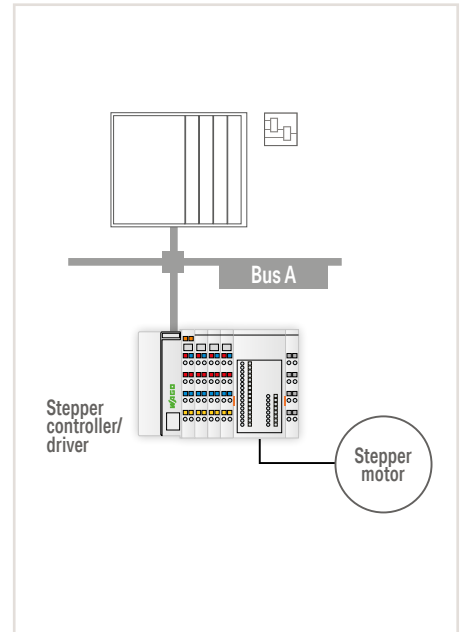
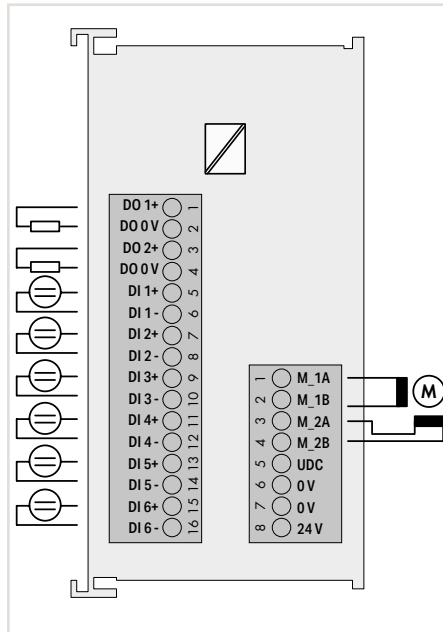
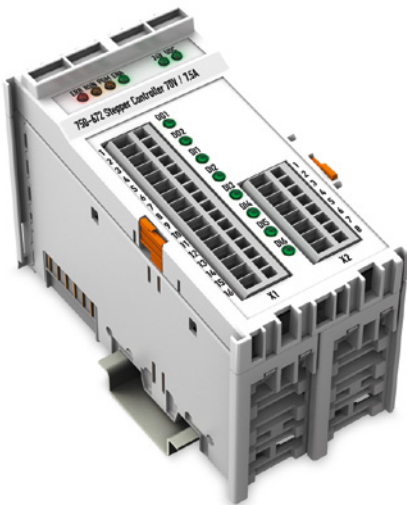
- Absolute/relative positioning
- Setpoint change on the fly
- Rotary axis

„ Mini-WSB marker card and mounting accessories, see Section "Accessories and Tools"

„ Approvals and corresponding ratings, see page 522 or [www.wago.com](http://www.wago.com)



## Stepper Controller



Item Description	Stepper Controller; 70 VDC; 7.5 A
Item No.	750-672
Order Text	Stepper Controller; 70 VDC; 7.5A
<b>Technical Data</b>	
Number of motor outputs	1 stepper motor (2 phases)
Supply voltage (motor)	55 VDC; Absolute upper limit: 71.5 V; Absolute lower limit: 18 V
Max. output current (motor)	2 x 5.0 A (2 x 7.5 A transient)
Stepper frequency	7812 Hz
Resolution	Path: 23 bits + sign bit; Speed: 15 bits + 16-bit prescaler; Acceleration: 15 bits + 16 bit- prescaler
Number of digital outputs	2
Control voltage	24 VDC (-25 ... +30 %)
Max. output current (digital outputs)	0.5 A; short-circuit-protected
Output frequency	5 Hz
Number of digital inputs	2 x 24 VDC
Input filter	100 µs; software filter can be connected
Current consumption – system supply (5 V)	70 mA
Data width (internal)	12-byte input/output
Isolation	500 V (system/field)
Surrounding air temperature (operation)	0 ... +55 °C
Dimensions W x H x D	48 x 69.8 x 100 mm
Approvals	CE,
Data sheet and further information, see:	<a href="http://wago.com/750-672">wago.com/750-672</a>

This stepper controller has an on-board power driver designed to control 2-phase stepper motors.

The 64-fold microstepping prevents step losses due to resonance in the acceleration phases and reduces wear on the mechanical parts. Adjustable current limits for stop, acceleration and constant speed help minimize motor power dissipation.

Six configurable inputs are directly processed by the internal software without delay. Two outputs can be linked with internal functions or freely allocated. Versatile functions enable a wide application range.

Inputs:

- Start/stop
- Limit switch (positive and negative direction)
- Reference cam
- Jog/tip (positive and negative direction)

Outputs (default setting):

- Target reached
- Error

Operating modes:

- Single positioning with different acceleration ramps
- Reference motion
- Jog
- Tip
- Command table
- Cam switch

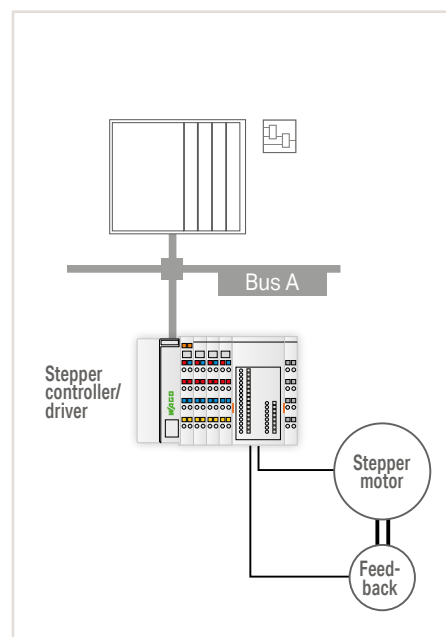
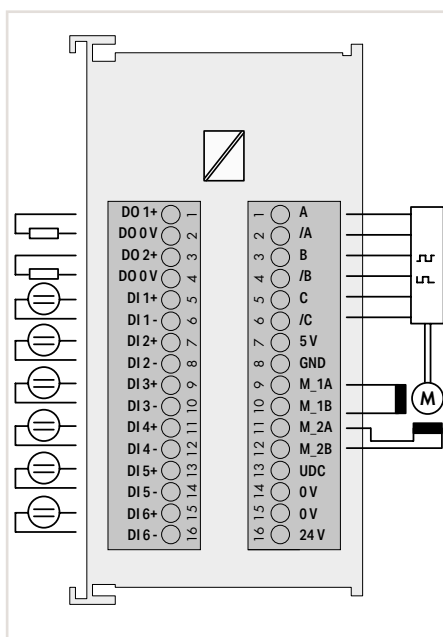
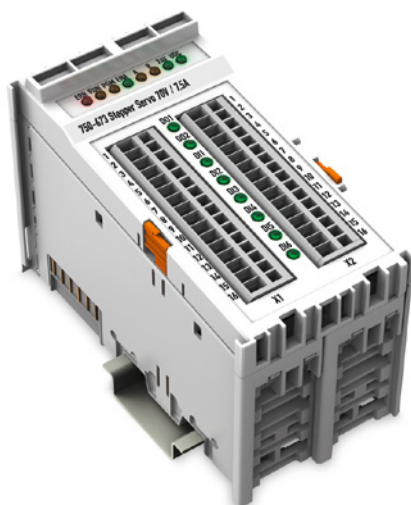
Functions include:

- Absolute/relative positioning
- Setpoint change on the fly
- Rotary axis

Protection:

- Short circuit monitoring of motor connections: Winding short circuit and short circuit to 0 V and 24 V
- 24 V supply: Reverse voltage protection
- Motor supply: Reverse voltage protection via external fuse

## Servo Stepper Controller



### Item Description

### Item No.

### Order Text

### Technical Data

#### Number of motor outputs

Supply voltage (motor)

#### Max. output current (motor)

#### Stepper frequency

#### Resolution

#### Number of digital outputs

#### Control voltage

#### Max. output current (digital outputs)

#### Output frequency

#### Number of digital inputs

#### Input filter

#### Signal voltage (encoder)

#### Encoder frequency

#### Sensor supply

#### Quadrature decoder

#### Counter Modules

#### Current consumption – system supply (5 V)

#### Data width (internal)

#### Isolation

#### Surrounding air temperature (operation)

#### Dimensions W x H x D

### Approvals

### Data sheet and further information, see:

### Servo Stepper Controller; 55 VDC; 7.5 A

### 750-673

### Servo Stepper Controller; 55 VDC; 7.5 A

1 stepper motor (2 phases)

55 VDC; Absolute upper limit: 71.5 V; Absolute lower limit: 18 V

2 x 5.0 A (2 x 7.5 A transient)

7812 Hz

Path: 23 bits + sign bit; Speed: 15 bits + 16-bit prescaler; Acceleration: 15 bits + 16-bit-prescaler

2

24 VDC (–25 ... +30 %)

0.5 A; short-circuit-protected

5 Hz

2 x 24 VDC

100 µs; software filter can be connected

RS-485/422 compatible

1 MHz

5 VDC; 300 mA; short-circuit-protected

4x evaluation

32 bits; binary

70 mA

12-byte input/output

500 V (system/field)

0 ... +55 °C

48 x 69.8 x 100 mm

CE;

[wago.com/750-673](http://wago.com/750-673)

This servo stepper controller has an on-board power driver and an incremental encoder evaluation for controlling 2-phase stepper motors.

The 64-fold microstepping prevents step losses due to resonance in the acceleration phases and reduces wear on the mechanical parts. Together with the incremental encoder, the integrated vector control contributes to efficient, dynamic rotation speed characteristics.

Six configurable inputs are directly processed by the internal software without delay. Two outputs can be linked with internal functions or freely allocated. Versatile functions enable a wide application range.

#### Inputs:

- Start/stop
- Limit switch (positive and negative direction)
- Reference cam
- Jog/tip (positive and negative direction)

#### Outputs (default setting):

- Target reached
- Error

#### Operating modes:

- Single positioning with different acceleration ramps
- Reference motion
- Jog
- Tip
- Command table
- Cam switch

#### Functions include:

- Absolute/relative positioning
- Setpoint change on the fly
- Rotary axis

#### Protection:

- Short circuit monitoring of motor connections: Winding short circuit and short circuit to 0 V and 24 V
- 24 V supply: Reverse voltage protection
- Motor supply: Reverse voltage protection via external fuse

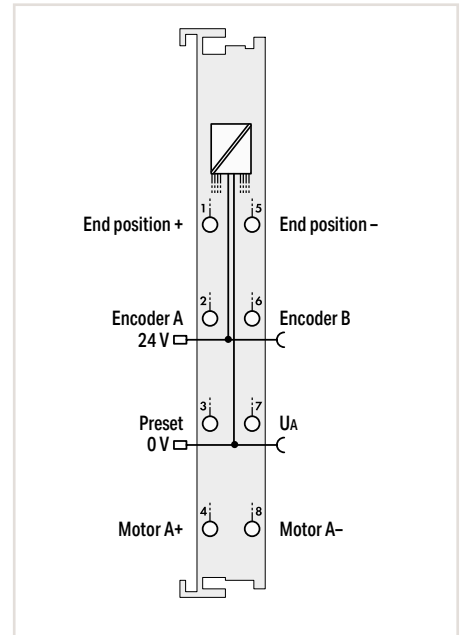
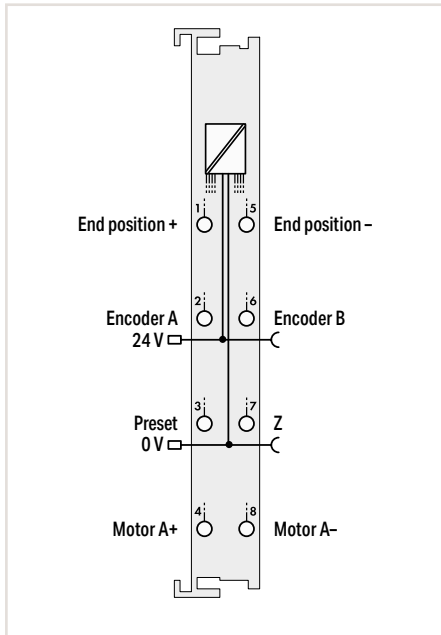
„ Mini-WSB marker card and mounting accessories, see Section “Accessories and Tools”

„ Approvals and corresponding ratings, see page 522 or [www.wago.com](http://www.wago.com)

# DC Drive Controller



Figure: 750-636



Item Description
Version
Item No.
Order Text

DC Drive Controller; 24 VDC; 5 A	
Standard	Extended temperature
750-636	750-636/025-000
DC-Drive Controller; 24 VDC; 5A	DC-Drive Controller; 24 VDC; 5A; T

DC Drive Controller; 24 VDC; 5 A	
Separate motor power supply	Interference-free
750-636/000-700	750-636/000-800
DC-Drive Controller; 24 VDC; 5A; UA	DC-Drive Controller; 24 VDC; 5A; IF

Technical Data	
Interference-free	
Number of outputs	1 (A+; A-; H-bridge output)
Motor voltage	24 VDC (-20 ... +15 %)
Separate motor voltage	
Output current (max.)	5 A (15 A/500 ms); short-circuit-protected
PWM frequency (typ.)	20 kHz
Number of digital inputs	3; Type 1; high-side switching
Signal voltage (0)	-3 ... +1.5 VDC
Signal voltage (1)	2.4 ... 30 VDC
Encoder connection	A; B; Zero low-side switching
Signal voltage	5 ... 24 VDC; Open collector
Limit frequency	50 kHz
Quadrature decoder	1x, 2x, 4x evaluation
Supply voltage (field)	5 ... 14 VDC (-15 ... +20 %); via power jumper contacts (power supply via blade contact; transmission via spring contact)
Current consumption – system supply (5 V)	55 mA
Data width (internal)	32-bit set/actual value; 16-bit control or status
Isolation	500 V (system/field)
Surrounding air temperature (operation)	0 ... +55 °C      -20 ... +60 °C
Dimensions W x H x D	12 x 67.8 x 100 mm
Approvals	CE,
Data sheet and further information, see:	<a href="http://wago.com/750-636">wago.com/750-636</a>

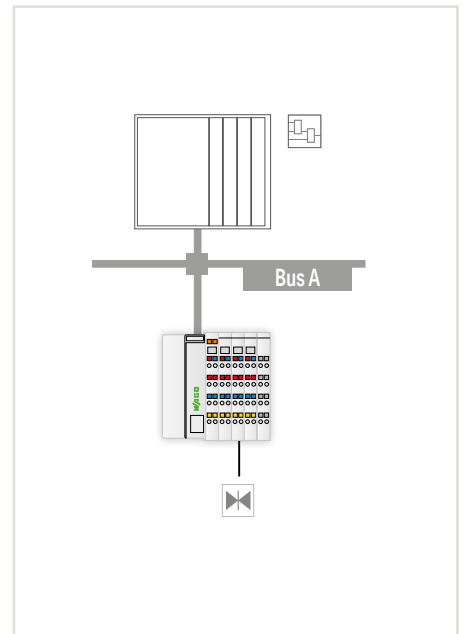
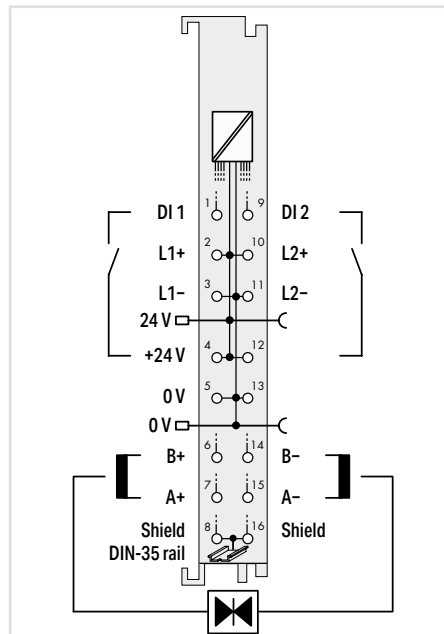
	●
	1 (A+; A-; H-bridge output)
	24 VDC (-20 ... +15 %)
	24 VDC (-20 ... +30 %)
	5 A (15 A/500 ms); short-circuit-protected
	20 kHz
	3; Type 1; high-side switching
	-3 ... +1.5 VDC
	2.4 ... 30 VDC
	A; B; Zero low-side switching
	5 ... 24 VDC; Open collector
	50 kHz
	1x, 2x, 4x evaluation
	5 ... 14 VDC (-15 ... +20 %); via power jumper contacts (power supply via blade contact; transmission via spring contact)
	55 mA
	32-bit set/actual value; 16-bit control or status
	500 V (system/field)
	0 ... +55 °C      -20 ... +60 °C
	12 x 67.8 x 100 mm
	CE,
	<a href="http://wago.com/750-636">wago.com/750-636</a>

	●
	1 (A+; A-; H-bridge output)
	24 VDC (-20 ... +15 %)
	24 VDC (-20 ... +30 %)
	5 A (15 A/500 ms); short-circuit-protected
	20 kHz
	3; Type 1; high-side switching
	-3 ... +1.5 VDC
	2.4 ... 30 VDC
	A; B; Zero low-side switching
	5 ... 24 VDC; Open collector
	50 kHz
	1x, 2x, 4x evaluation
	5 ... 14 VDC (-15 ... +20 %); via power jumper contacts (power supply via blade contact; transmission via spring contact)
	55 mA
	32-bit set/actual value; 16-bit control or status
	500 V (system/field)
	0 ... +55 °C
	12 x 67.8 x 100 mm
	CE,
	<a href="http://wago.com/750-636">wago.com/750-636</a>

This DC drive controller is a single-channel, intelligent positioning controller for 24 VDC motors up to 5 A with incremental position feedback. Three 24 V inputs record the limit switches and a preset signal. An incremental encoder interface evaluates signals from the position sensor and determines actual value. Current reduction is possible via pulse width modulation (PWM).

As an option, the motor voltage can be supplied separately.

## Proportional Valve Module



Item Description	Proportional valve controller
Version	Standard with 16 connectors
Item No.	750-632
Order Text	Proportional Valve Module
<b>Technical Data</b>	
Number of outputs	2 bipolar outputs (A+; A- and B+; B-)
Output current (max.)	1-channel operation: 2 A; 2-channel operation: 1.6 A per channel
Output type	H-bridge output with current-regulated PWM output (short-circuit-proof and thermal over-load-proof for each channel)
Dither frequency	250 Hz; 125 Hz; 62.5 ... 1 Hz (parameterizable)
PWM frequency (typ.)	50 kHz
Nominal output voltage	24 VDC (-25 ... +30 %)
Load type	Operating range: inductive (1 mH ... 600 mH); Internal load resistance (> 8 Ohm)
Number of digital inputs	2; Type 1; high-side switching
Supply voltage (field)	24 VDC (-25 % ... +30 %); via power jumper contacts (power supply via blade contact; transmission via spring contact)
Current consumption – system supply (5 V)	125 mA
Data width (internal)	6 bytes (single-channel operating mode), 12 bytes (dual-channel operating mode)
Isolation	500 V (system/field)
Surrounding air temperature (operation)	0 ... +55 °C
Dimensions W x H x D	12 x 69 x 100 mm
Approvals	CE; Marine; OrdLoc/HazLoc; ATEX/IECEx
Data sheet and further information, see:	<a href="http://wago.com/750-632">wago.com/750-632</a>

This proportional valve module controls two single-coil valves or one valve. The module features two current-controlled PWM outputs with adjustable dither. Both unipolar and bipolar valve control are possible. Additionally, operation of a valve with two unipolar coils is also provided. The module is single-channel in this operating mode! Characteristic curve adaptations, such as zero offset, dual gain compensation or range limitations, can be adjusted via parameters. The module functions can be internally triggered via digital outputs without any detours.

„ Mini-WSB marker card and mounting accessories, see Section "Accessories and Tools"

„ Approvals and corresponding ratings, see page 522 or [www.wago.com](http://www.wago.com)

5.6

# Communication Modules

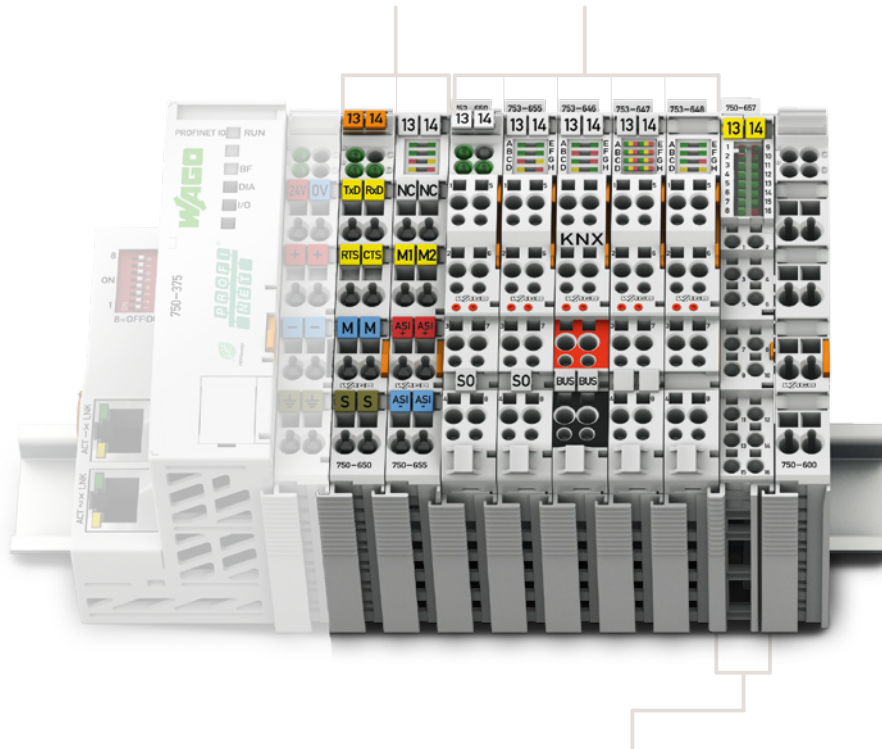


## Housing design (750 Series)

Dimensions W x H x D	Housing with 4 LEDs: 12 x 69.8 x 100 mm Housing with 8 LEDs: 12 x 67.8 x 100 mm
Height from upper-edge of DIN-rail	Housing with 4 LEDs: 62.6 mm Housing with 8 LEDs: 60.6 mm
Connection technology	CAGE CLAMP®
Conductor cross section	0.08 ... 2.5 mm <sup>2</sup> / 28 ... 14 AWG
Strip length	8 ... 9 mm / 0.33 inch

## Housing design (753 Series)

Dimensions W x H x D	Housing with 4 LEDs: 12 x 69.8 x 100 mm Housing with 8 LEDs: 12 x 69 x 100 mm
Height from upper-edge of DIN-rail	Housing with 4 LEDs: 62.6 mm Housing with 8 LEDs: 61.8 mm
Connection technology	CAGE CLAMP®
Conductor cross section	0.08 ... 2.5 mm <sup>2</sup> / 28 ... 14 AWG
Strip length	9 ... 10 mm / 0.37 inch



## Housing design (750 Series), with Push-in CAGE CLAMP® connections (up to 16 connection points)

Dimensions W x H x D	12 x 69 x 100 mm
Height from upper-edge of DIN-rail	61.8 mm
Connection technology	Push-in CAGE CLAMP®
Conductor cross section	Solid: 0.08 ... 1.5 mm <sup>2</sup> / 28 ... 16 AWG Fine-stranded: 0.25 ... 1.5 mm <sup>2</sup> / 22 ... 16 AWG
Strip length	8 ... 9 mm / 0.33 inch



I/O System –  
750 XTR Series

## I/O-System – 750 and 753 Series, Communication Modules

### Contents

Function	Description	Item Number			Page
		Standard	Extended Temperature	Pluggable	
Serial Interfaces	Serial Interface RS-232 C; 9600 baud	750-650		753-650	278
	Serial Interface RS-232 C; 9600 baud; 5 bytes	750-650/000-001			278
	Serial Interface RS-232 C; 9600 baud; Even; 7/2 bits	750-650/000-002			278
	Serial Interface RS-232 C; 9600 baud; Even; 8/1 bits	750-650/000-006			278
	Serial Interface RS-232 C; 19200 baud; None; 8/1 bits	750-650/000-010			279
	Serial Interface RS-232 C; 19200 baud; Even; 8/1 bits	750-650/000-011			279
	Serial Interface RS-232 C; 2400 baud; None; 8/1 bits	750-650/000-012			279
	Serial Interface RS-232 C; 4800 baud; Even; 8/1 bits; 5 bytes	750-650/000-015			279
	Serial Interface RS-232 C; Adjustable	750-650/003-000		753-650/003-000	279
	Serial Interface RS-485	750-653	750-653/025-018	753-653	280
	Serial Interface RS-485; 9600 baud; Even; 7/2 bits	750-653/000-001			280
	Serial Interface RS-485; 9600 baud; Even; 8/1 bits	750-653/000-002			280
	Serial Interface RS-485; 19200 baud; None; 8/1 bits; 5 bytes	750-653/000-006			281
	Serial Interface RS-485; 2400 baud; None; 8/1 bits	750-653/000-007			281
	Serial Interface RS-485; Adjustable	750-653/003-000	750-653/025-000	753-653/003-000	281
	Serial Interface RS-232/485	750-652*	750-652/025-000	753-652	282
	Serial TTY Interface; 9600 baud; None; 8/1 bits	750-651			283
	Serial TTY Interface; 9600 baud; Even; 8/1 bits	750-651/000-002			283
EnOcean	Radio Receiver EnOcean	750-642			284
KNX	KNX/EIB/TP1 Interface			753-646	285
DALI	DALI Multi-Master			753-647	286
LON®	LON® FTT Interface			753-648	287
MP-Bus	MP-Bus Master	750-643			288
M-Bus	M-Bus Master			753-649	289
SMI	SMI Master Module; for drives with 230 VAC			753-1630	290
	SMI Master Module; Low voltage			753-1631	290
AS-Interface Master	AS-Interface Master	750-655		753-655	291
IO-Link Master	IO-Link Master	750-657			292
CAN Gateway	CAN Gateway	750-658*			293
Data Exchange	Serial Data Exchange Interface	750-654			294
*This module is also available as a 750 XTR Series variant.					See Section 6

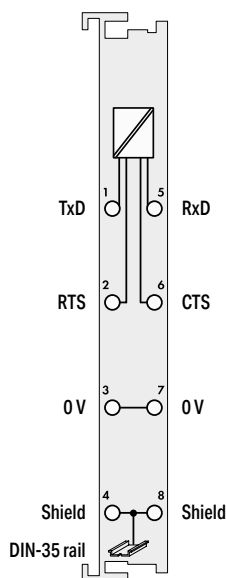
## Serial Interface RS-232 C



Figure: 750-650



Figure: 753-650



5.7

Item Description	Serial Interface RS-232 C				
Version	9600 baud	9600 baud; Pluggable (delivery without connector)	9600 baud; 5 bytes	9600 baud; Even; 7/2 bits	9600 baud; Even; 8/1 bits
Item No.	750-650	753-650	750-650/000-001	750-650/000-002	750-650/000-006
Order Text	RS232 C Interface; 9600Bd	RS232 C Interface; 9600Bd	RS232 C Interface; 9600Bd; 5byte	RS232 C Interface; 9600Bd; E; 7/2	RS232 C Interface; 9600Bd; E; 8/1

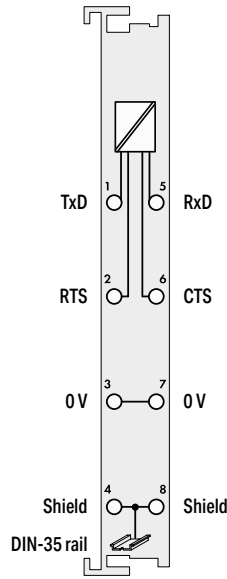
Technical Data				
Pluggable connector	●			
Signal type	RS-232			
Transmission channels	1 TxD / 1 RxD; full-duplex			
Baud rate	9600 Bd			
Parity	None		Even	
Number of data bits	8		7	8
Number of stop bits	1		2	1
Buffer	120-byte input / 16-byte output			
Supply voltage (system)	5 VDC; via data contacts			
Current consumption – system supply (5 V)	55 mA			
Data width (internal)	1 x 24-bit input/output (3-byte user data); 1 x 8-bit control/status	1 x 24-bit input/ output (5-byte user data); 1 x 8-bit control/ status	1 x 24-bit input/output (3-byte user data); 1 x 8-bit control/status	
Isolation	500 V (system/field)			
Surrounding air temperature (operation)	0 ... +55 °C			
Dimensions W x H x D	12 x 69.8 x 100 mm			
Approvals	CE; Marine; OrdLoc/HazLoc; ATEX/IECEX			
Data sheet and further information, see:	<a href="http://wago.com/750-650">wago.com/750-650</a>	<a href="http://wago.com/753-650">wago.com/753-650</a>	<a href="http://wago.com/750-650">wago.com/750-650</a>	

Accessories	Item No.
Pluggable connector	753-110
Coding keys	753-150

„ Mini-WSB marker card and mounting accessories, see Section "Accessories and Tools"

„ Approvals and corresponding ratings, see page 522 or [www.wago.com](http://www.wago.com)





**Serial Interface RS-232 C**

4800 baud; Even; 8/1 bits; 5 bytes	2400 baud; None; 8/1 bits	19,200 baud; None; 8/1 bits	19,200 baud; Even; 8/1 bits	Adjustable	Adjustable; Pluggable (delivery without connector);
750-650/000-015	750-650/000-012	750-650/000-010	750-650/000-011	750-650/003-000	753-650/003-000
RS232 C Interface; 4800Bd; E; 8/1	RS232 C Interface; 2400Bd; N; 8/1	RS232 C Interface; 19200Bd; N; 8/1	RS232 C Interface; 19200Bd; E; 8/1	RS232 C Interface; adjust	RS232 C Interface; adjust

RS-232			
1 TxD / 1 RxD; full-duplex			
4800 Bd	2400 Bd	19,200 Bd	1200 ... 57,600 Bd
Even	None		None/even; adjustable
	8		7/8; adjustable
	1		1/2; adjustable
120-byte input / 16-byte output			
5 VDC; via data contacts			
55 mA			
1 x 24-bit input/output (5-byte user data); 1 x 8-bit control/status	1 x 24-bit input/output (3-byte user data); 1 x 8-bit control/status		1 x 24-bit input/output (3-byte user data); 1 x 40-bit input/output (5-byte user data); 1 x 8-bit control/status
500 V (system/field)			
0 ... +55 °C			
12 x 69.8 x 100 mm			
CE; Marine; OrdLoc/HazLoc; ATEX/IECEX			
<a href="http://wago.com/750-650">wago.com/750-650</a>			<a href="http://wago.com/750-650/003-000">wago.com/ 750-650/003-000</a>
			<a href="http://wago.com/753-650/003-000">wago.com/ 753-650/003-000</a>

<b>Item No.</b>
753-110
753-150

## Serial Interface RS-485



Figure: 750-653

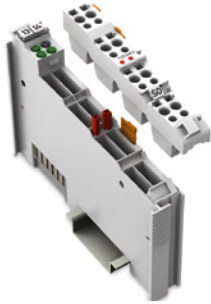
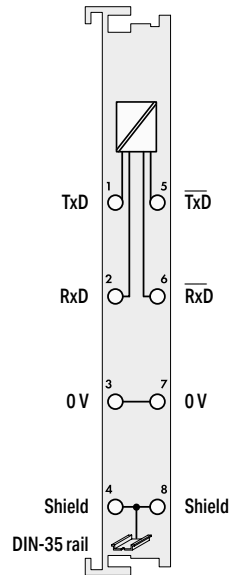


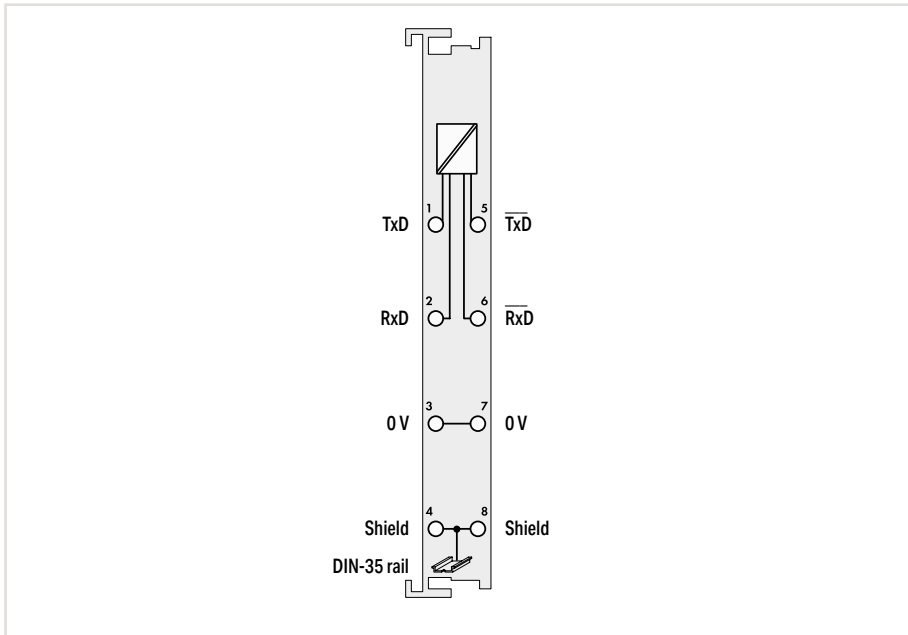
Figure: 753-653



5.7

Item Description		Serial Interface RS-485				
Version		Standard	Pluggable (delivery without connector)	9600 baud; Even; 7/2 bits	9600 baud; Even; 8/1 bits	9600 baud; None; 8/1 bits; Extended temperature
Item No.	750-653	753-653	750-653/000-001	750-653/000-002	750-653/025-018	
Order Text	RS485 Interface	RS485 Interface	RS485 Interface; 9600Bd; E; 7/2	RS485 Interface; 9600Bd; E; 8/1	RS485 Interface; 9600Bd; N; 8/1	
<b>Technical Data</b>						
Pluggable connector		•				
Signal type		RS-422/-485				
Transmission channels		1 TxD / 1 RxD; full-duplex				
Baud rate		9600 Bd				
Parity		None	Even		None	
Number of data bits		8	7	8		
Number of stop bits		1	2		1	
Buffer		120-byte input / 16-byte output				
Supply voltage (system)		5 VDC; via data contacts				
Current consumption – system supply (5 V)		65 mA				
Data width (internal)		1 x 24-bit input/output (3-byte user data); 1 x 8-bit control/status			1 x 40-bit input/output (5-byte user data); 1 x 8-bit control/status	
Isolation		500 V (system/field)				
Surrounding air temperature (operation)		0 ... +55 °C			-20 ... +60 °C	
Dimensions W x H x D		12 x 69.8 x 100 mm				
Approvals		CE; Marine; OrdLoc/HazLoc; ATEX/IECEX				
Data sheet and further information, see:		<a href="http://wago.com/750-653">wago.com/750-653</a>	<a href="http://wago.com/753-653">wago.com/753-653</a>	<a href="http://wago.com/750-653">wago.com/750-653</a>		
<b>Accessories</b>						
Pluggable connector		Item No. 753-110				
Coding keys		753-150				

„ Mini-WSB marker card and mounting accessories, see Section "Accessories and Tools"  
 „ Approvals and corresponding ratings, see page 522 or www.wago.com



Serial Interface RS-485				
19,200 baud; None; 8/1 bits	2400 baud; None; 8/1 bits	Adjustable	Adjustable; Extended temperature	Adjustable; Pluggable (delivery without connector)
750-653/000-006	750-653/000-007	750-653/003-000	750-653/025-000	753-653/003-000
RS485 Interface; 19200Bd; N; 8/1	RS485 Interface; 2400Bd; N; 8/1	RS485 Interface; adjust	RS485 Interface; adjust; T	RS485 Interface; adjust

RS-422/-485				
1 TxD / 1 RxD; full-duplex				
19,200 Bd	2400 Bd	1200 ... 19,200 Bd		
None		None/even; adjustable		
8		7/8; adjustable		
1		1/2; adjustable		
120-byte input / 16-byte output				
5 VDC; via data contacts				
65 mA				
1 x 40-bit input/ output (5-byte user data); 1 x 8-bit control/ status	1 x 24-bit input/ output (3-byte user data); 1 x 8-bit control/ status	1 x 40-bit input/output (3/5-byte user data); 1 x 8-bit control/status		
500 V (system/field)				
0 ... +55 °C		-20 ... +60 °C	0 ... +55 °C	
12 x 69.8 x 100 mm				
CE; Marine; OrdLoc/HazLoc; ATEX/IECEx				
wago.com/750-653			wago.com/ 753-653	

Item No.
753-110
753-150

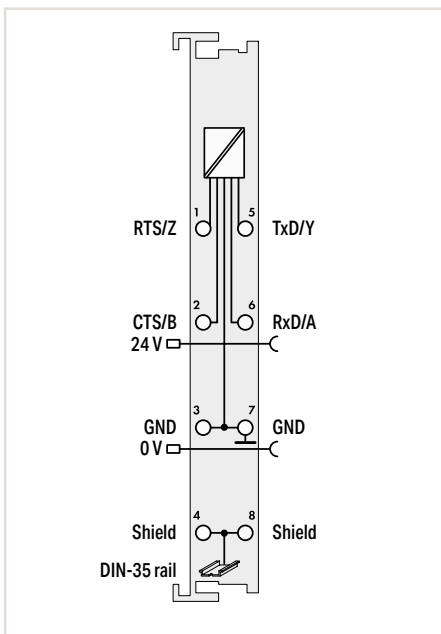
## Serial Interface RS-232/485



Figure: 750-652



Figure: 753-652



5.7

Item Description		Serial Interface RS-232/485	
Version		Standard	Extended temperature
Item No.		750-652	750-652/025-000
Order Text		RS232/485 Interface	RS232/485 Interface; T
			Pluggable (delivery without connector)
			753-652
			RS232/485 Interface
<b>Technical Data</b>			
Pluggable connector			•
Signal type		RS-232 / RS-422 / RS-485	
Transmission channels		1 TxD / 1 RxD; full-duplex; half-duplex	
Baud rate		9600 Bd (default setting); 300 ... 11,5200 Bd	
Parity		None/Odd/Even	
Number of data bits		7/8; adjustable	
Number of stop bits		1/2; adjustable	
Buffer		2560 bytes for reception / 512 bytes for transmission	
Supply voltage (field)		24 VDC; via power jumper contacts (power supply via blade contact; transmission via spring contact)	
Supply voltage (system)		5 VDC; via data contacts	
Current consumption – system supply (5 V)		85 mA	
Data width (internal)		8, 24 or 48 bytes (parameterizable)	
Isolation		500 V (system/field)	
Surrounding air temperature (operation)		0 ... +55 °C	
Dimensions W x H x D		12 x 67.8 x 100 mm	12 x 69 x 100 mm
Approvals		CE; Marine; OrdLoc/HazLoc; ATEX/IECEX	
Data sheet and further information, see:		<a href="http://wago.com/750-652">wago.com/750-652</a>	<a href="http://wago.com/753-652">wago.com/753-652</a>
<b>Accessories</b>		<b>Item No.</b>	
Pluggable connector		753-110	
Coding keys		753-150	

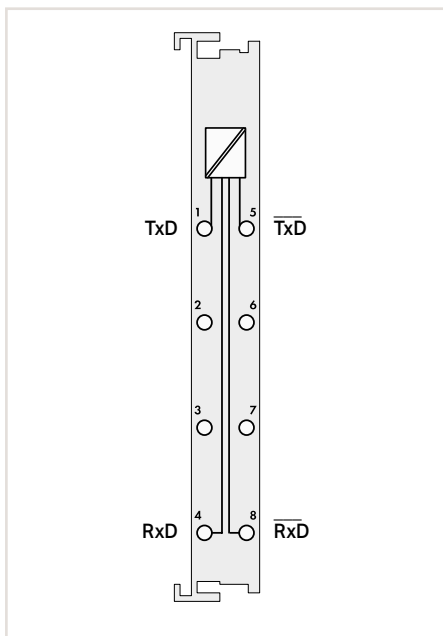
„ Mini-WSB marker card and mounting accessories, see Section "Accessories and Tools"

„ Approvals and corresponding ratings, see page 522 or [www.wago.com](http://www.wago.com)

# Serial TTY Interface



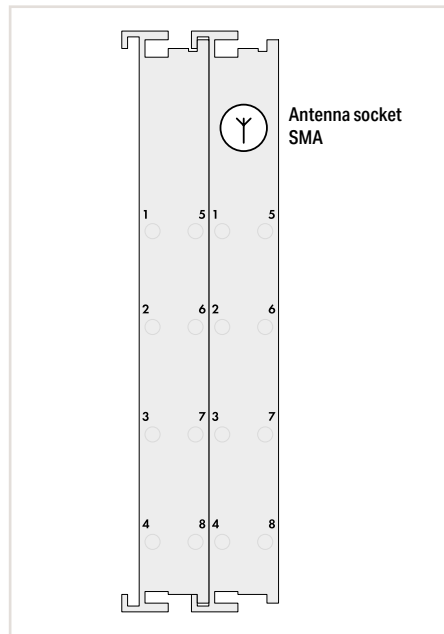
Figure: 750-651



5.7

Item Description		Serial TTY Interface	
Version		9600 baud; None; 8/1 bits	9600 baud; Even; 8/1 bits
Item No.		750-651	750-651/000-002
Order Text		TTY Interface; 9600Bd; N; 8/1	TTY Interface; 9600Bd; E; 8/1
<b>Technical Data</b>			
Signal type		TTY; 20 mA	
Transmission channels		1 Tx̄D / 1 Rx̄D; full-duplex	
Baud rate		9600 Bd	
Load impedance		< 500 Ω	
Parity		None	Even
Number of data bits		8	
Number of stop bits		1	
Buffer		128-byte input / 16-byte output	
Supply voltage (system)		5 VDC; via data contacts	
Current consumption – system supply (5 V)		55 mA	
Data width (internal)		1 x 24-bit input/output (3-byte user data); 1 x 8-bit control/status	
Isolation		500 V (system/field)	
Surrounding air temperature (operation)		0 ... +55 °C	
Dimensions W x H x D		12 x 69.8 x 100 mm	
Approvals		Marine;  OrdLoc/HazLoc	
Data sheet and further information, see:		<a href="http://wago.com/750-651">wago.com/750-651</a>	

## Radio Receiver EnOcean



5.7

<b>Item Description</b>	<b>Radio Receiver EnOcean</b>				
<b>Version</b>	<b>Standard</b>				
<b>Item No.</b>	<b>750-642</b>				
<b>Order Text</b>	Radio Receiver EnOcean				
<b>Technical Data</b>					
Antenna	External via SMA socket				
Frequency band	868.3 MHz				
Transmission range	Up to 300 m in open field (30 m typical in buildings, see manual)*				
Transmission protocol (radio telegram)	EnOcean				
Supply voltage (system)	5 VDC; via data contacts				
Current consumption – system supply (5 V)	80 mA				
Data width (internal)	1 x 24-bit input/output (3-byte user data); 1 x 8-bit control/status				
Surrounding air temperature (operation)	0 ... +55 °C				
Dimensions W x H x D	24 x 72 x 100 mm				
<b>Approvals</b>	CE, RoHS, OrdLoc/HazLoc, ATEX/IECEX				
<b>Data sheet and further information, see:</b>	<a href="http://wago.com/750-642">wago.com/750-642</a>				
<b>Accessories</b>					
External antenna	<table border="1"> <thead> <tr> <th>Item No.</th> <th>Page</th> </tr> </thead> <tbody> <tr> <td>758-910</td> <td>424</td> </tr> </tbody> </table>	Item No.	Page	758-910	424
Item No.	Page				
758-910	424				

This radio receiver obtains radio telegrams from maintenance-free, self-powered and wireless switches/sensors based on EnOcean radio technology.

The energy required for switch or sensor operation is produced by converting one type of energy (heat, solar or mechanical energy) into usable electrical energy.

The LED (RSSI) indicates a sufficient input level.

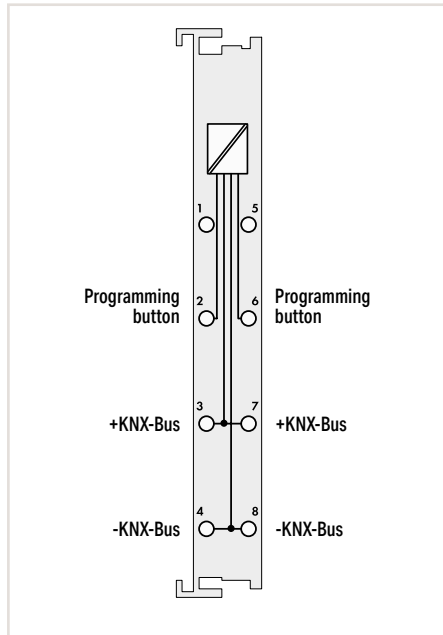
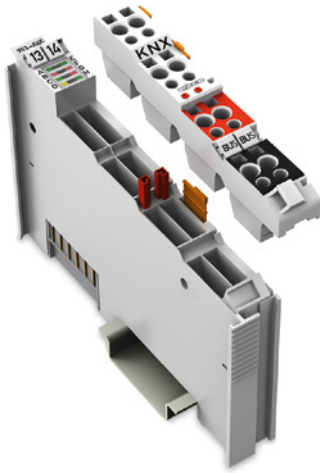
Preprogrammed function blocks for WAGO Controllers make integration easy.

\*The maximum range in the field decreases with use in buildings and changes depending on the building materials used and the spatial geometry. Therefore, range specifications within buildings can only represent typical values which can normally be achieved. More detailed information is available in the manual.

„ Mini-WSB marker card and mounting accessories, see Section "Accessories and Tools"

„ Approvals and corresponding ratings, see page 522 or [www.wago.com](http://www.wago.com)

## KNX/EIB/TP1 Interface



<b>Item Description</b>	<b>KNX/EIB/TP1 Interface</b>
<b>Version</b>	<b>Pluggable</b>
<b>Item No.</b>	<b>753-646</b>
<b>Order Text</b>	KNX/EIB/TP1 Interface
<b>Technical Data</b>	
Pluggable connector	•
Specification	KNX/TP1 bus: 1.0
Number of communication objects	253
Number of group addresses	254
Number of associations	254
Baud rate	9.6 kBd
Additional connections	Programming button
Applicability	On controllers
Current consumption – system supply (5 V)	25 mA
Data width (internal)	24 bytes
Isolation	2500 V rms
Surrounding air temperature (operation)	0 ... +55 °C
Dimensions W x H x D	12 x 69 x 100 mm
<b>Approvals</b>	CE; Marine; OrdLoc
<b>Data sheet and further information, see:</b>	<a href="http://wago.com/753-646">wago.com/753-646</a>
<b>Accessories</b>	<b>Item No.</b>
Pluggable connector	Included
Coding keys	Included

The KNX/EIB/TP1 Module connects to a KNX/EIB/TP1 network. This module supports two different functions:

### 1. Device mode:

With this module, all programmable fieldbus controllers relevant for building automation can be connected to a KNX/TP1 network. The module is a standard KNX device and is linked via ETS3/4 Professional Commissioning Tool.

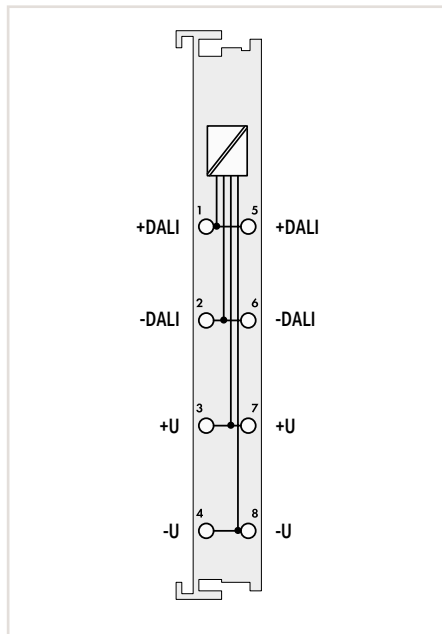
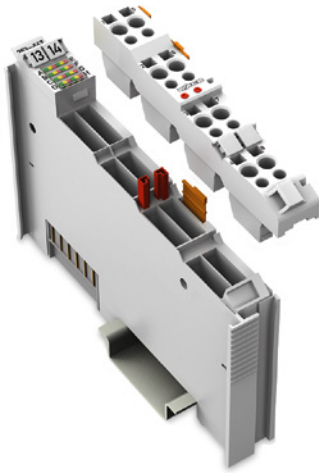
An ETS3/4 plug-in is required so that data from the application program can be allocated to group addresses for the programming software.

### 2. Router mode:

When connected to a KNX/IP Controller (e.g., 750-889), the combination becomes a KNXnet/IP router. The module is switched to the router mode automatically. An application program is not required for operation in router mode. Additional modules that are connected to a KNX IP Controller are addressed in device mode by the application.

The bus connections are internally bridged inside the plug, so the bus is not interrupted when the plug is pulled from the module. The plug is included with delivery.

## DALI Multi-Master



<b>Item Description</b>	<b>DALI Multi-Master</b>
<b>Version</b>	<b>Pluggable</b>
<b>Item No.</b>	<b>753-647</b>
<b>Order Text</b>	DALI Multi-Master

### Technical Data

Pluggable connector	•
Number of participants	64 control gears (EVG) + 16 multi-sensors (max. 64 addresses for control devices (sensors))
Baud rate	1200 bit/s
Bus length (max.)	300 m
Bus topology	Star/line/combination
Supply voltage (DALI)	18 V (external)
Number of groups	16 (+ 16 virtual groups)
Number of scenes	16
Applicability	On programmable fieldbus controllers
Current consumption – system supply (5 V)	85 mA
Data width (internal)	24 bytes
Isolation	1500 V DALI bus/local bus
Surrounding air temperature (operation)	0 ... +55 °C
Dimensions W x H x D	12 x 69 x 100 mm
<b>Approvals</b>	CE; Marine; OrdLoc
<b>Data sheet and further information, see:</b>	<a href="http://wago.com/753-647">wago.com/753-647</a>

### Accessories

	<b>Item No.</b>	<b>Page</b>
DALI Multi-Master DC/DC Converter (for supplying a single module)	753-620	330
Switched-Mode Power Supply; for DALI Multi-Master (753-647); 1-phase; Output voltage: 18 VDC; Output current: 1.1 A	787-1007	493
Pluggable connector	Included	
Coding keys	Included	

This manufacturer-independent DALI standard ensures interoperability of DALI devices in lighting applications. This standard is substitute for the 1–10 V dimmer interface.

In addition to 64 DALI actuators (ECGs), a DALI Multi-Master Module supports up to 16 multi-sensors (max. 64 sensor addresses). Each DALI ECG can be assigned to 16 groups and 16 scenes. The DALI Multi-Master Module also offers 16 additional virtual groups on the DALI bus.

DALI control devices can be seamlessly integrated with all other building systems. Several DALI masters can be connected to a single fieldbus node. The maximum number of modules that can be connected to a controller depends on the memory required by the application. Function blocks prepared for DALI are available for programming fieldbus nodes.

Alternatively, an "EASY Mode" allows lighting functions to be readily controlled without any PLC programming.

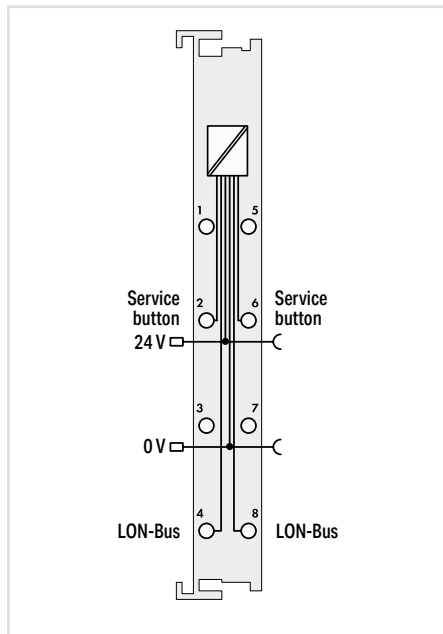
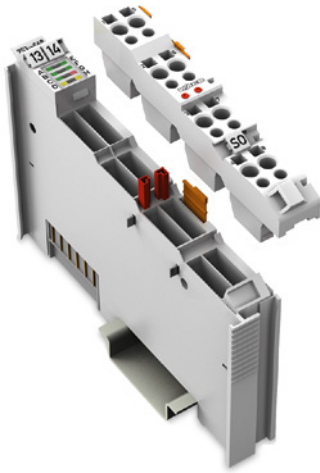
The DALI Configurator (Section "Software"/ Page 39) simplifies commissioning of the DALI network. It provides the following functions: easy commissioning, configuration, service, support and maintenance of the DALI network.

„ Mini-WSB marker card and mounting accessories, see Section "Accessories and Tools"

„ Approvals and corresponding ratings, see page 522 or [www.wago.com](http://www.wago.com)



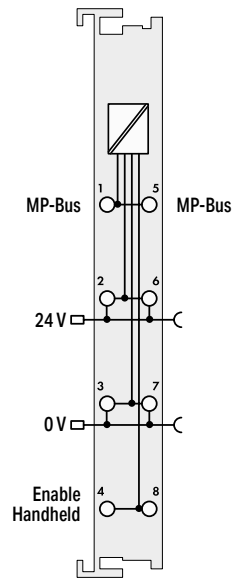
## LON® FTT Interface



<b>Item Description</b>	<b>LON® FTT Interface</b>
<b>Version</b>	<b>Pluggable</b>
<b>Item No.</b>	<b>753-648</b>
<b>Order Text</b>	LON FTT Interface
<b>Technical Data</b>	
Pluggable connector	●
Number of network variables	249
Number of aliases	127
Baud rate	78 kbit/s
Bus length (max.)	500 m (free topology) / 2700 m (bus)
Transmission medium	Twisted Pair – FTT
Additional connections	Service button
Applicability	On controllers; max. 2 per controller
Supply voltage (field)	24 VDC; via power jumper contacts (power supply via blade contact; transmission via spring contact)
Current consumption – system supply (5 V)	30 mA
Data width (internal)	24 bytes
Isolation	500 V (system/field)
Surrounding air temperature (operation)	0 ... +55 °C
Dimensions W x H x D	12 x 69.8 x 100 mm
<b>Approvals</b>	CE; UL; OrdLoc/HazLoc
<b>Data sheet and further information, see:</b>	<a href="http://wago.com/753-648">wago.com/753-648</a>
<b>Accessories</b>	
Pluggable connector	Included
Coding keys	Included

The LON® FTT Interface is a full-fledged and flexible LON® device within LonWorks® FT or LP network. The module's network variable interface defines 249 network variables of any type and supports both LonMark® objects and configuration properties.

## MP-Bus Master



<b>Item Description</b>	<b>MP-Bus Master</b>
<b>Version</b>	<b>Standard</b>
<b>Item No.</b>	750-643
<b>Order Text</b>	MP-Bus Master
<b>Technical Data</b>	
Number of participants	Max. 8 slaves
Supply voltage (MP-Bus)	24 VDC; via power jumper contacts
Bus length (max.)	800 m
Applicability	On controllers
Supply voltage (field)	24 VDC; via power jumper contacts (power supply via blade contact; transmission via spring contact)
Current consumption – system supply (5 V)	15 mA
Data width (internal)	8 bytes
Isolation	500 V (system/field)
Surrounding air temperature (operation)	0 ... +55 °C
Dimensions W x H x D	12 x 69.8 x 100 mm
<b>Approvals</b>	CE;  OrdLoc/HazLoc;  ATEX/IECEX
<b>Data sheet and further information, see:</b>	<a href="http://wago.com/750-643">wago.com/750-643</a>

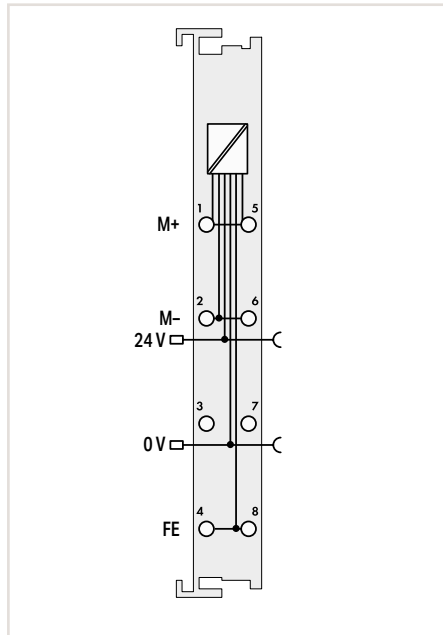
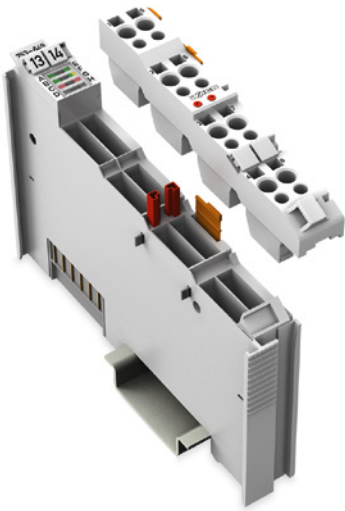
This module acts as a master for the MP bus (Multi-Point bus from Belimo/Switzerland) and allows the bus to be integrated into a higher level bus network. The MP-Bus controls HVAC actuators for dampers, regulator valves or VAV air volume controls.

The actuators have connections for active and passive sensors (temperature, humidity, ON/OFF switch), which may also be accessed via MP-Bus. An MP-Bus master can manage up to 8 slaves (actuators) + 8 sensors (1 sensor per slave) via a common bus line, which considerably reduces actuator and sensor wiring.

„ Mini-WSB marker card and mounting accessories, see Section “Accessories and Tools”

„ Approvals and corresponding ratings, see page 522 or [www.wago.com](http://www.wago.com)

## M-Bus Master



<b>Item Description</b>	M-Bus Master
<b>Version</b>	Pluggable
<b>Item No.</b>	753-649
<b>Order Text</b>	M-Bus Master
<b>Technical Data</b>	
Pluggable connector	●
Transmission channels	1; bidirectional
Baud rate	up to 1000 m at 9600 baud; up to 2000 m at 2400 baud; up to 6000 m at 300 baud
M-Bus loads (max.)	40 (1.5 mA each)
Topology	Star, tree and line topology
Supply voltage (field)	24 VDC (-2.5 ... +5 %); via power jumper contacts (power supply via blade contact; transmission via spring contact)
Current consumption, field supply (module with no external load)	130 mA
Supply voltage (system)	5 VDC; via data contacts
Current consumption – system supply (5 V)	29 mA
Isolation	500 V (system/field)
Cable type	2-line; shielded or unshielded
Data width	24 bytes (mailbox 2.0 with 22-byte length)
Startup and configuration	WAGO-I/O-PRO V2.3; e!COCKPIT
<b>Approvals</b>	CE,
<b>Data sheet and further information, see:</b>	<a href="http://wago.com/753-649">wago.com/753-649</a>
<b>Accessories</b>	<b>Item No.</b>
Pluggable connector	Included
Coding keys	Included

# SMI Master Module

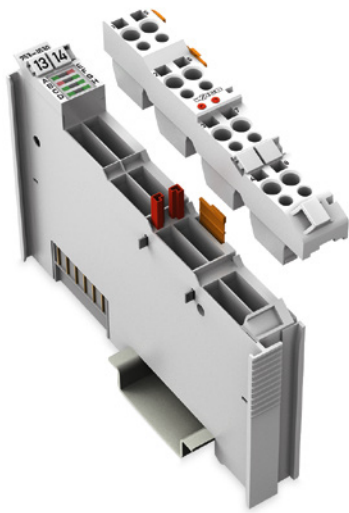
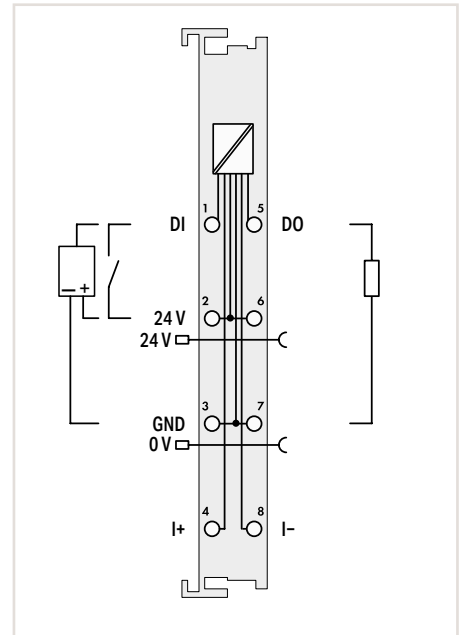
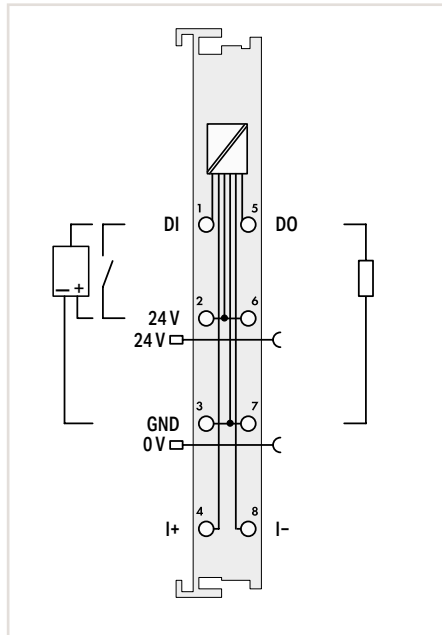


Figure: 753-1630



5.7

<b>Item Description</b>
<b>Version</b>
<b>Item No.</b>
<b>Order Text</b>

<b>SMI Master; 230 VAC</b>
<b>Pluggable</b>
<b>753-1630</b>
<b>SMI Master; 230 VAC</b>

<b>SMI Master LoVo; 24 VDC</b>
<b>Pluggable</b>
<b>753-1631</b>
<b>SMI Master LoVo; 24 VDC</b>

<b>Technical Data</b>
Number of channels
Interface specification
Number of digital inputs
Input characteristic
Input voltage (max.)
Number of digital outputs
Output current per channel
Supply voltage (field)
Current consumption, field supply (module with no external load)
Supply voltage (system)
Current consumption – system supply (5 V)
Isolation
Cable type
Cable length
Data width
Startup and configuration
<b>Approvals</b>
<b>Data sheet and further information, see:</b>

1 x SMI (1 ... 16 SMI slaves per channel)
SMI Master interface per SMI specification
1
Type 1
31.2 VDC
1
0.5 ADC; short-circuit protected
24 VDC (–25 ... +30 %); via power jumper contacts (power supply via blade contact; transmission via spring contact)
11.8 mA
5 VDC; via data contacts
33 ... 42 mA
3 kVAC RMS; 4 kV surge (system/SMI); 1.5 kVAC RMS; 2.5 kV surge (system/field)
2-line; unshielded
350 m
12-byte data
Via WAGO SMI Configurator or IEC libraries
CE,
<a href="http://wago.com/753-1630">wago.com/753-1630</a>

1 x SMI (1 ... 16 SMI slaves per channel)
SMI Master interface per SMI specification
1
Type 1
31.2 VDC
1
0.5 ADC; short-circuit protected
24 VDC (–25 ... +30 %); via power jumper contacts (power supply via blade contact; transmission via spring contact)
11.8 mA
5 VDC; via data contacts
33 ... 42 mA
3 kVAC RMS; 4 kV surge (system/SMI); 1.5 kVAC RMS; 2.5 kV surge (system/field)
2-line; unshielded
350 m
12-byte data
Via WAGO SMI Configurator or IEC libraries
CE,
<a href="http://wago.com/753-1631">wago.com/753-1631</a>

<b>Accessories</b>
Pluggable connector
Coding keys

<b>Item No.</b>
Included
Included

<b>Item No.</b>
Included
Included

„ Mini-WSB marker card and mounting accessories, see Section "Accessories and Tools"  
 „ Approvals and corresponding ratings, see page 522 or [www.wago.com](http://www.wago.com)

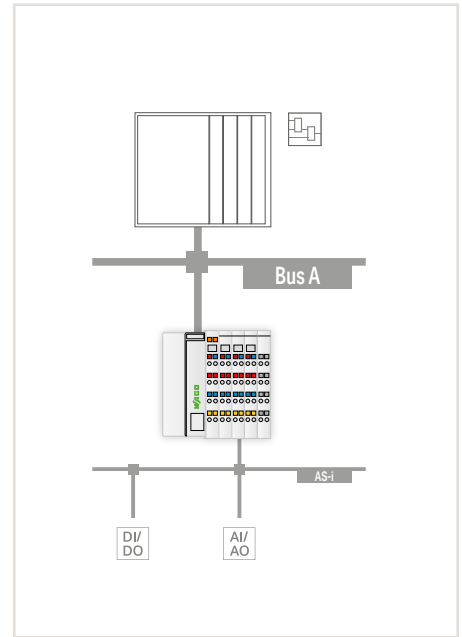
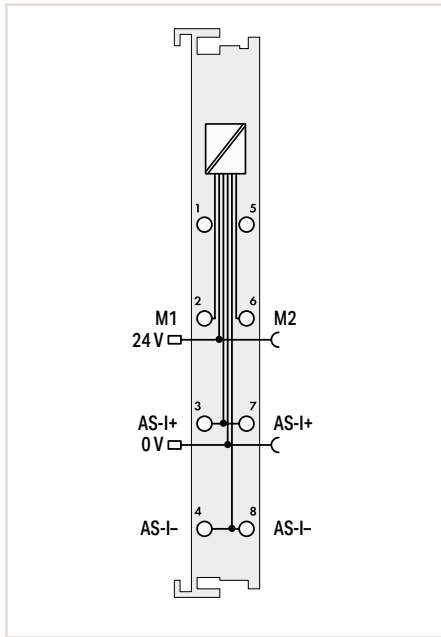
# AS-Interface Master



Figure: 750-655



Figure: 753-655



Item Description
Version
Item No.
Order Text

AS-Interface Master	
Standard	Pluggable (delivery without connector)
750-655	753-655
AS-Interface Master	AS-Interface Master

The AS-Interface Master Module connects AS-Interface devices to a higher-level fieldbus. It acts as a master for the AS-Interface and via the fieldbus coupler, as a slave for the fieldbus. The AS-i functions are provided both cyclically and acyclically via the fieldbus.

Technical Data	
Pluggable connector	
AS-i master class	M4
Number of slaves	62
Slave profiles	V3.0 with transaction types 1 ... 5
Cable length	100 m (with repeater 300 m)
AS-i cycle time	0.3 ... 10 ms
Supply voltage (AS-i)	26.5 ... 31.6 V
Supply voltage (field)	24 VDC (-15 ... +20 %); via power jumper contacts (power supply via blade contact; transmission via spring contact)
Current consumption – system supply (5 V)	55 mA
Data width (internal)	12 ... 48 bytes (max.); Configurable, including 1 byte control/status
Isolation	500 V (system/field)
Surrounding air temperature (operation)	0 ... +55 °C
Dimensions W x H x D	12 x 67.8 x 100 mm   12 x 69 x 100 mm

	●
	M4
	62
	V3.0 with transaction types 1 ... 5
	100 m (with repeater 300 m)
	0.3 ... 10 ms
	26.5 ... 31.6 V
	24 VDC (-15 ... +20 %); via power jumper contacts (power supply via blade contact; transmission via spring contact)
	55 mA
	12 ... 48 bytes (max.); Configurable, including 1 byte control/status
	500 V (system/field)
	0 ... +55 °C
	12 x 67.8 x 100 mm   12 x 69 x 100 mm

Diagnostics, which go far beyond the AS-i specifications, simplify detection of both sporadic configuration errors and AS-i communication interference sources. An auto-installation mode allows an AS-Interface network to be created via sequential slave installation, with no addressing tool required.

Approvals
CE;  Marine;  OrdLoc/HazLoc;  ATEX/IECEX
Data sheet and further information, see:
<a href="http://wago.com/750-655">wago.com/750-655</a>   <a href="http://wago.com/753-655">wago.com/753-655</a>

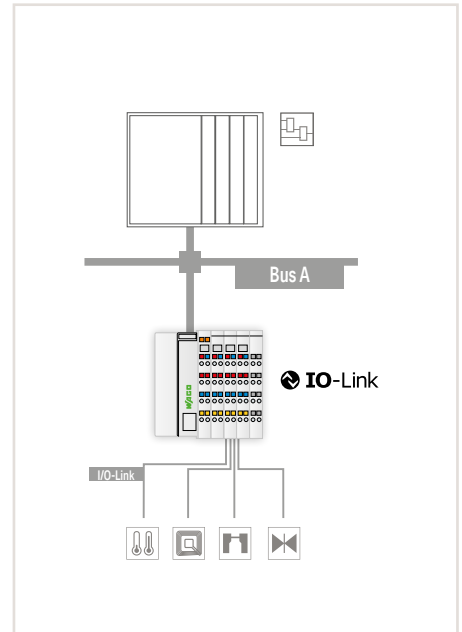
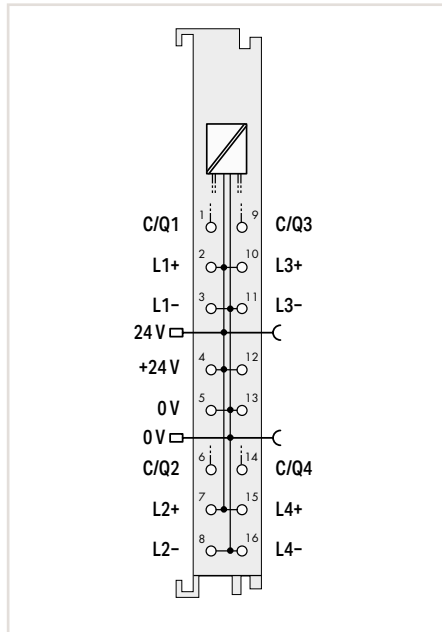
CE;  Marine;  OrdLoc/HazLoc;  ATEX/IECEX
<a href="http://wago.com/750-655">wago.com/750-655</a>   <a href="http://wago.com/753-655">wago.com/753-655</a>

Both signal transmission and operating status, as well as trouble-free local bus communication, are indicated via LEDs.

Accessories	
Pluggable connector	753-110
Coding keys	753-150

Item No.
753-110
753-150

# IO-Link Master



5.7

<b>Item Description</b>
<b>Version</b>
<b>Item No.</b>
<b>Order Text</b>

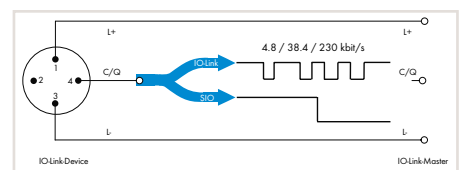
<b>IO-Link Master</b>
<b>Standard with 16 connectors</b>
<b>750-657</b>
IO-Link Master

<b>Technical Data</b>	
Number of I/O-Link ports	4
Baud rate	4.8 Kbit/s; 38.4 Kbit/s; 230.4 Kbit/s
Cable length	20 m
Supply voltage (field)	24 VDC (-15 ... +20 %); via power jumper contacts (power supply via blade contact; transmission via spring contact)
Current consumption – system supply (5 V)	40 mA
Data width (internal)	4 ... 24 bytes
Isolation	500 V (system/field)
Surrounding air temperature (operation)	0 ... +55 °C
Dimensions W x H x D	12 x 69 x 100 mm
<b>Approvals</b>	CE; OrdLoc/HazLoc; ATEX/IECEX
<b>Data sheet and further information, see:</b>	<a href="http://wago.com/750-657">wago.com/750-657</a>

<b>Technical Data</b>	
Number of I/O-Link ports	4
Baud rate	4.8 Kbit/s; 38.4 Kbit/s; 230.4 Kbit/s
Cable length	20 m
Supply voltage (field)	24 VDC (-15 ... +20 %); via power jumper contacts (power supply via blade contact; transmission via spring contact)
Current consumption – system supply (5 V)	40 mA
Data width (internal)	4 ... 24 bytes
Isolation	500 V (system/field)
Surrounding air temperature (operation)	0 ... +55 °C
Dimensions W x H x D	12 x 69 x 100 mm
<b>Approvals</b>	CE; OrdLoc/HazLoc; ATEX/IECEX
<b>Data sheet and further information, see:</b>	<a href="http://wago.com/750-657">wago.com/750-657</a>

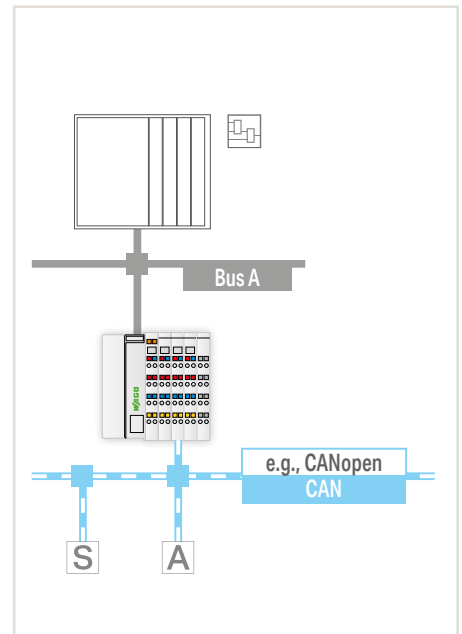
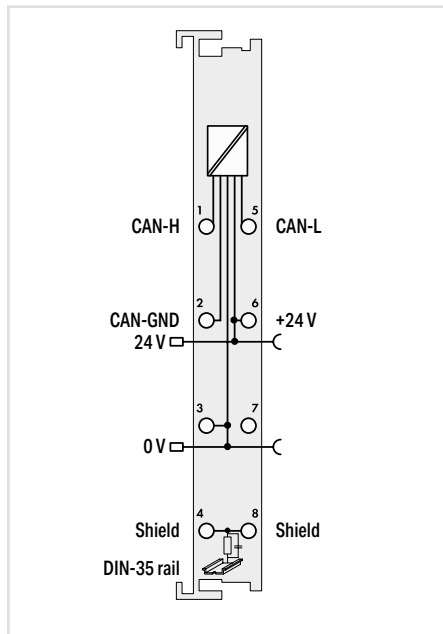
Four different IO-Link devices or standard digital sensors/actuators can simultaneously connect to the IO-Link Master. Process data, as well as acyclic data for identification, configuration, parameterization and diagnostics can be communicated to the respective device via a 3-wire connection.

The functions and performance data are defined in device description files for master and devices; these are easy to customize via engineering tool. If a device must be replaced, the IO-Link devices' configuration and parameterization can be automatically restored without maintenance personnel. Project design, installation and operation are simplified!



„ Mini-WSB marker card and mounting accessories, see Section "Accessories and Tools"  
 „ Approvals and corresponding ratings, see page 522 or [www.wago.com](http://www.wago.com)

## CAN Gateway



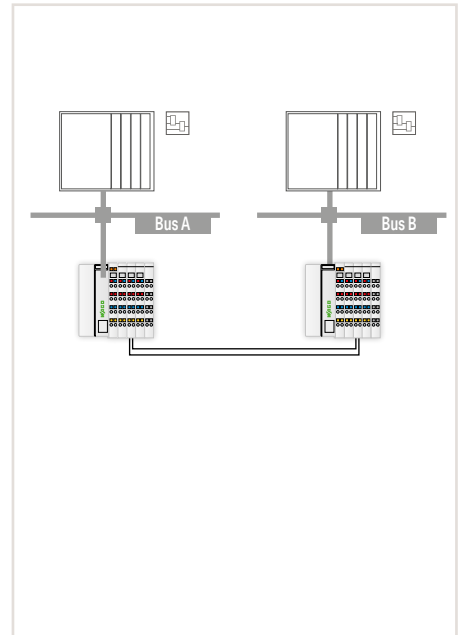
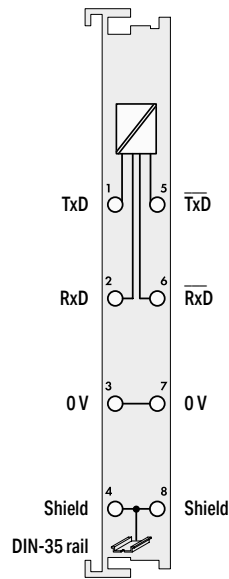
<b>Item Description</b>	<b>CAN Gateway</b>
<b>Version</b>	<b>Standard</b>
<b>Item No.</b>	<b>750-658</b>
<b>Order Text</b>	CAN Gateway
<b>Technical Data</b>	
Number of CAN interfaces	1
Baud rate	10 kbit/s; 20 kbit/s; 50 kbit/s; 125 kbit/s; 250 kbit/s; 500 kbit/s; 800 kbit/s (automatic baud rate)
Data formats	Per 2.0 A standard (11-bit ID); Per 2.0 B extended (29-bit ID)
Supply voltage (field)	24 VDC; via power jumper contacts (power supply via blade contact; transmission via spring contact)
Current consumption – system supply (5 V)	50 mA
Data transfer time	5 ms (at 32-bit I/O)
Data width (internal)	4 ... 24 bytes
Isolation	500 V (system/field)
Surrounding air temperature (operation)	0 ... +55 °C
Dimensions W x H x D	12 x 67.8 x 100 mm
<b>Approvals</b>	CE;  Marine;  OrdLoc/HazLoc; ATEX/IECEX
<b>Data sheet and further information, see:</b>	<a href="http://wago.com/750-658">wago.com/750-658</a>

The CAN Gateway allows a CAN bus to be installed as a sub-bus beneath a fieldbus coupler or controller. It enables special sensors/actuators that are only available with the widely used CAN bus to also be integrated under other bus systems. Function blocks allow the gateway to read and write higher-protocol telegrams (e.g., CANopen).

The module offers three different operating modes:

- Sniffer mode: Detailed analysis of the CAN bus through passive "snooping"
- Transparent mode: Active CAN subscriber that can send and receive any type of CAN telegram
- Mapped mode: Enables direct generation of CAN telegrams from the process image, or selective copying of process values from received CAN telegrams into the input process image (cyclic or event-based)

## Serial Data Exchange Interface



### Item Description

Version

Item No.

Order Text

### Technical Data

Transmission channels

Baud rate

Bit transfer

Line impedance

Line length (max.)

Current consumption – system supply (5 V)

Data width (internal)

Isolation

Surrounding air temperature (operation)

Dimensions W x H x D

### Approvals

Data sheet and further information, see:

### Serial Data Exchange Interface

Standard

750-654

Data Exchange Interface

1 TxD / 1 RxD; full-duplex

62500 Bd (8 N 1)

Via 2 twisted pairs with differential signals

120 Ω

1000 m

65 mA

1 x 32-bit input/output; 1 x 8-bit control/status

500 V (system/field)

0 ... +55 °C

12 x 69.8 x 100 mm

CE; Marine; OrdLoc

[wago.com/750-654](http://wago.com/750-654)

This data exchange interface allows the exchange of data between different fieldbus systems. Two modules form a communication pair that is installed in fieldbus nodes and connected by two twisted wire pairs. The data exchange is done in full duplex operation, independent of the fieldbus system used. The data at the output of the fieldbus coupler is transmitted to the communication partner. This module then transmits the data to the input process image of its fieldbus coupler and vice versa. The "function" LED indicates a data exchange with the coupler. The status of the data transmission is indicated by the TxD and RxD LEDs.

„ Mini-WSB marker card and mounting accessories, see Section "Accessories and Tools"

„ Approvals and corresponding ratings, see page 522 or [www.wago.com](http://www.wago.com)



5.7

# Functional Safety

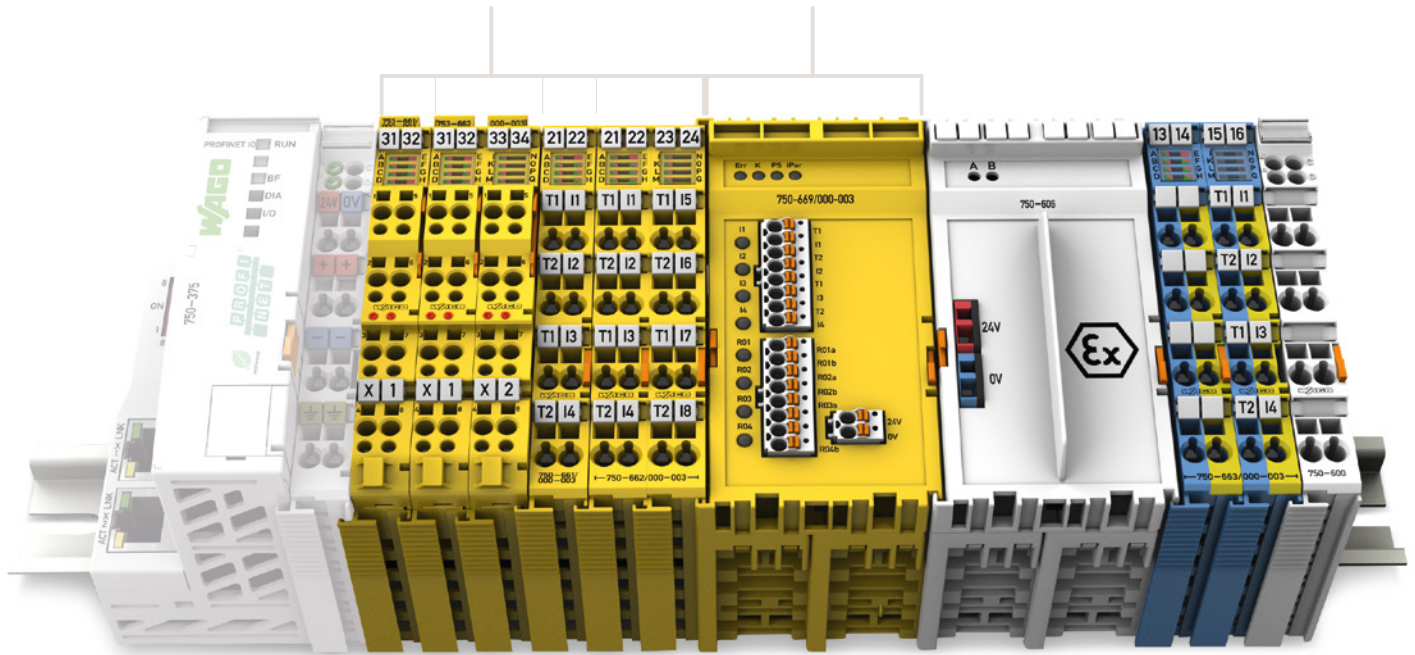


## Housing design (750/753 Series)

Dimensions W x H x D	750 Series: 12 or 24 x 67.8 x 100 mm 753 Series: 12 or 24 x 69 x 100 mm
Height from upper-edge of DIN-rail	750 Series: 60.6 mm; 753 Series: 61.8 mm
Connection technology	CAGE CLAMP®
Conductor cross section	0.08 ... 2.5 mm <sup>2</sup> / 28 ... 14 AWG
Strip length	750 Series: 8 ... 9 mm / 0.33 inch 753 Series: 9 ... 10 mm / 0.37 inch

## Specialty housing

Dimensions W x H x D	48 x 69.8 x 100
Height from upper-edge of DIN-rail	62.6 mm
Connection technology	Push-in CAGE CLAMP®
Conductor cross section	0.05 ... 1.5 mm <sup>2</sup> / 20 ... 14 AWG
Strip length	8 ... 9 mm / 0.33 inch

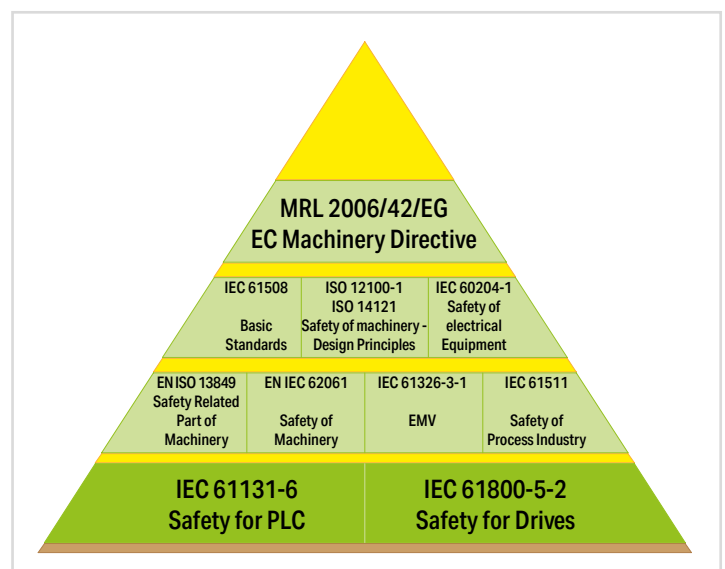


## Functional Safety

In the European Union, the machinery directive defines the requirements for machine and system safety. This ensures a uniform standard for the protection of "life and limb" for people within a machine's operating area.



The required risk assessment is based on harmonized standards (e.g., EN 13849) and identifies existing risks and required risk reduction (SIL or PL quality). Based on the risk assessment, safety functionality can be implemented, e.g., by presence detection or protection zone violations using secure switches or light arrays to immediately shut down the "risk." For this purpose, the safety signals are detected by the "yellow" safety modules and transmitted via "PROFIsafe" to the fail-safe PLC for further processing. The result is then executed via safe actuator (e.g., output module or controller).

The unique characteristic safety values of the WAGO modules facilitate calculation of the final safety function up to Cat. 4/PLe according to EN 13849, or SIL3 according to EN 62061 or IEC 61511.



## I/O System – 750 and 753 Series, Functional Safety

### Contents

Function	Description	Item Number		Page
		Standard	Pluggable	
Fail-Safe Digital Inputs PROFIsafe	Fail-Safe Digital Input, 8 Channels; 24 VDC; PROFIsafe	750-660/000-001		302
	Fail-Safe Digital Input, 4 Channels; 24 VDC; PROFIsafe V 2.0 iPar	750-661/000-003	753-661/000-003	303
	Fail-Safe Digital Input, 8 Channels; 24 VDC; PROFIsafe V 2.0 iPar	750-662/000-003	753-662/000-003	303
Fail-Safe Digital Inputs/Outputs PROFIsafe	Fail-Safe Digital Input/Output, 4/4 Channels; 24 VDC; 0.5 A; PROFIsafe	750-665/000-001		302
	Fail-Safe Digital Input/Output, 4/2 Channels; 24 VDC; 10 A; PROFIsafe V 2.0 iPar	750-666/000-003	753-666/000-003	304
	Fail-Safe Digital Input/Output, 4/4 Channels; 24 VDC; 2 A; PROFIsafe V 2.0 iPar	750-667/000-003	753-667/000-003	304
	Fail-Safe Digital Input/Relay Output, 4/4 Channels; 48 VAC/60 VDC; 6 A; PROFIsafe V 2.0 iPar	750-669/000-003		306
Intrinsically Safe Digital Input for Functional Safety	Intrinsically Safe 4-Channel Digital Input; 24 VDC; PROFIsafe V 2.0 iPar	750-663/000-003		307
	Classification of binary 24 V interfaces with testing in the field of functional safety according to position paper CB241 of ZVEI (German Electrical and Electronic Manufacturer's Association)			298
<b>Supply Modules Ex i</b> 	The intrinsically safe I/O module with inputs for functional safety (750-663/000-003) must only be operated using an Ex i 24 VDC power supply (e.g., 750-606, 750-625/000-001)! General information (e.g., installation regulations) on explosion protection is available in the WAGO-I/O-SYSTEM 750 manuals!			
	Supply Module; 24 VDC; Diagnostics; Intrinsically safe	750-606		310
	Power Supply; 24 VDC; Intrinsically safe	750-625/000-001		310
<b>Filter Modules</b> 	The mixed operation of safe and conventional I/O modules streamlines system configuration. For increased electromagnetic immunity (EMC standard), WAGO offers compact power supply filter modules (see Section 4.10). Specific power supply features must be considered, which are described in the corresponding manuals.			
	Field Supply Filter (Surge); 24 VDC; Higher isolation	750-624/020-000		334
	Supply Filter; 24 VDC; Higher isolation	750-626/020-000		336

# Position Paper CB24I of the German Electrical and Electronic Manufacturer's Association (ZVEI)

Fail-safe digital interfaces differ from conventional digital interfaces through higher safety testing for both inputs and outputs. They include dynamic digital interfaces of different characteristics and functions. At first glance, the combination of inputs to outputs results in a variety of possible variants due to the different applications.

For this reason, ZVEI has issued the Position Paper CB24i in order to increase functional safety and simplify engineering processes.

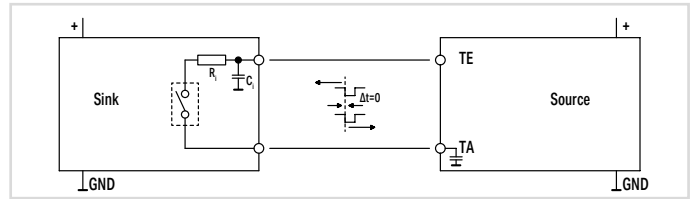
The purpose of this paper is to:

- describe terms
- define characteristics of interface types
- specify product information (technical data) per interface type to be supplied by the manufacturer.

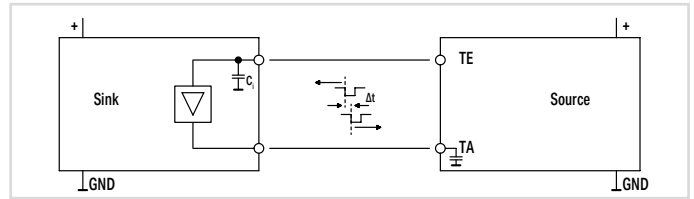
This paper provides a technical description for all interface types. No safety-related assessment is made.

The variety of possible combinations was divided into just four interface types:

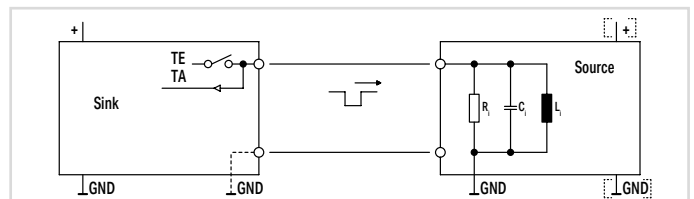
For both interface types C and D, four "performance" classes are also available to match the time requirements of the test pulses.



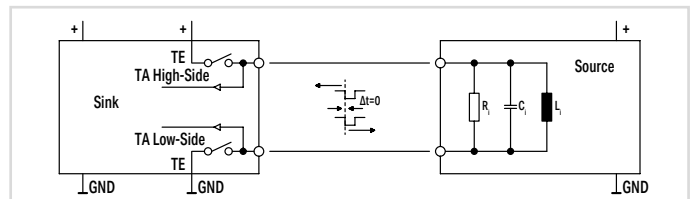
Interface type A



Interface type B



Interface type C



Interface type D

The identifying key has the following structure:

Source/Sink	Interface type (and class)	Additional measures "M"	Sink/Source	Suitable interface type (and class)	Suitable interface type (and class)	Suitable interface type (and class)
-------------	----------------------------	-------------------------	-------------	-------------------------------------	-------------------------------------	-------------------------------------

The first position describes the interface type and, if necessary, the class of the product. The second position indicates if additional measures are necessary. Next, the interface type suitable for this product is specified. Up to three interface types can be indicated. A row can only contain interface types of the same kind. Depending on the product, several identifying keys may also be used.

### Examples:

a) Manufacturer information for a source of interface type C/class 2 (e.g., sensor):

Source	C2		Sink	C1	C2	
--------	----	--	------	----	----	--

Explanation: In this case, a source of type C2 is compatible with a sink of type C1 and also with a sink of type C2.

b) Manufacturer information for a sink of interface type C/class 2 (e.g., safety PLC):

Sink	C2		Source		C2	C3
------	----	--	--------	--	----	----

Explanation: In this case, a sink of type C2 is compatible with a source of type C2 and also with a sink of type C3.

c) Manufacturer information for a sink of interface type A (e.g., safety evaluation unit):

Sink	A	M	Source	A		
------	---	---	--------	---	--	--

Explanation: In this case, a sink of type A is compatible with a source of type A subject to "M" additional measures.

Complete information can be found in the ZVEI Position Paper CB24i. This position paper is available for download in German and English via the ZVEI website.

# Classification of Binary 24 V Interfaces with Testing in the Field of Functional Safety per ZVEI Position Paper CB24I

WAGO – Functional Safety		Identifying Key per ZVEI Position Paper CB24I										
Description	Item No.	Source/Sink	Interface type	Additional measures "M"	Measures			Sink/Source	Suitable interface type	Suitable interface type	Suitable interface type	Suitable interface type
					Parameterize filter time, short circuit test	Parameterize/switch off test pulse duration	Protected wiring					
<b>Inputs</b>												
Fail-Safe Digital Input, 8 Channels; 24 VDC; PROFIsafe	750-660/000-001	Sink	A	-				Source	A	-	-	-
		Sink	C0	M	x			Source	C0	C1	C2	C3
Fail-Safe Digital Input, 4 Channels; 24 VDC; PROFIsafe V 2.0 iPar	750-661/000-003	Sink	A	-				Source	A	-	-	-
		Sink	C0	M	x			Source	C0	C1	C2	C3
Fail-Safe Digital Input, 4 Channels; 24 VDC; PROFIsafe V 2.0 iPar	753-661/000-003	Sink	A	-				Source	A	-	-	-
		Sink	C0	M	x			Source	C0	C1	C2	C3
Fail-Safe Digital Input, 8 Channels; 24 VDC; PROFIsafe V 2.0 iPar	750-662/000-003	Sink	A	-				Source	A	-	-	-
		Sink	C0	M	x			Source	C0	C1	C2	C3
Fail-Safe Digital Input, 8 Channels; 24 VDC; PROFIsafe V 2.0 iPar	753-662/000-003	Sink	A	-				Source	A	-	-	-
		Sink	C0	M	x			Source	C0	C1	C2	C3
<b>Inputs/Outputs</b>												
Fail-Safe Digital Input/Output, 4/4 Channels; 24 VDC; 0.5 A; PROFIsafe	750-665/000-001	Sink	A	M				Source	A	-	-	-
		Source	C0	M				Sink	C0	-	-	-
Fail-Safe Digital Input/Output, 4/2 Channels; 24 VDC; 10 A; PROFIsafe V 2.0 iPar	750-666/000-003	Sink	A	-				Source	A	-	-	-
		Sink	C0	M	x			Source	C0	C1	C2	C3
		Source	C0	M		x		Sink	C0	C1	C2	C3
		Source	D0	M		x		Sink	D0	D1	D2	D3
Fail-Safe Digital Input/Output, 4/2 Channels; 24 VDC; 10 A; PROFIsafe V 2.0 iPar	753-666/000-003	Sink	A	-				Source	A	-	-	-
		Sink	C0	M	x			Source	C0	C1	C2	C3
		Source	C0	M		x		Sink	C0	C1	C2	C3
		Source	D0	M		x		Sink	D0	D1	D2	D3
Fail-Safe Digital Input/Output, 4/4 Channels; 24 VDC; 2 A; PROFIsafe V 2.0 iPar	750-667/000-003	Sink	A	-				Source	A	-	-	-
		Sink	C0	M	x			Source	C0	C1	C2	C3
		Source	C0	M		x		Sink	C0	C1	C2	C3
		Source	D0	M		x		Sink	D0	D1	D2	D3
Fail-Safe Digital Input/Output, 4/4 Channels; 24 VDC; 2 A; PROFIsafe V 2.0 iPar	753-667/000-003	Sink	A	-				Source	A	-	-	-
		Sink	C0	M	x			Source	C0	C1	C2	C3
		Source	C0	M		x		Sink	C0	C1	C2	C3
		Source	D0	M		x		Sink	D0	D1	D2	D3
Fail-Safe Digital Input/Relay Output, 4/4 Channels; 48 VAC/60 VDC; 6 A; PROFIsafe V 2.0 iPar	750-669/000-003	Sink	A	-				Source	A	-	-	-
		Sink	C0	M	x			Source	C0	C1	C2	C3
		Source	A	-				Sink	A	-	-	-
		Source	C0	M			x	Sink	C0	C1	C2	C3
<b>Intrinsically Safe Input</b>												
Intrinsically Safe 4-Channel Digital Input; 24 VDC; PROFIsafe V 2.0 iPar	750-663/000-003	Sink	A	-				Source	A	-	-	-
		Sink	C0	M	x			Source	C0	C1	C2	C3

5.8

## Classification of Binary 24 V Interfaces with Testing in the Field of Functional Safety per ZVEI Position Paper CB241

Interface Type A – Sink		Item: 75x-661/000-003; 75x-662/000-003; 75x-666/000-003; 75x-667/000-003; 750-669/000-003			Item: 75x-663/000-003	
Parameter	Min.	Typ. (24 V)	Max.	Min.	Typ. (24 V)	Max.
Input current $I_i$ (in the ON state)	>2 mA	-	<9 mA	>2 mA	3 mA	<9 mA
Output voltage $U_i$	Field power supply -0.2 V	-	-	Field power supply -0.2 V	-	-
Input capacitance $C_i$	-	-	12 nF	-	-	12 nF
Additional measure "M"	• Parameterize filter time; activate short circuit test			• Parameterize filter time; activate short circuit test		

Interface Type C – Sink, Class C0		Item: 75x-661/000-003; 75x-662/000-003; 75x-666/000-003; 75x-667/000-003; 750-669/000-003			Item: 75x-663/000-003	
Parameter	Min.	Typ. (24 V)	Max.	Min.	Typ. (24 V)	Max.
Test pulse duration $t_i$	0.5 ms	-	200 ms	0.5 ms	-	200 ms
Test pulse interval T	18 ms	42 ms	1230 ms	18 ms	42 ms	1230 ms
Input resistance R	-	3.6 k $\Omega$	8.5 k $\Omega$	-	2.4 k $\Omega$	8.5 k $\Omega$
Input capacitance $C_L$	-	-	12 nF	-	-	12 nF
Inductance $L_L$	-	-	-	-	-	-
Additional measure "M"	• Parameterize filter time • Deactivate short circuit test			• Parameterize filter time • Deactivate short circuit test		

Interface Type C – Sink, Class C1		Item: 75x-661/000-003; 75x-662/000-003; 75x-666/000-003; 75x-667/000-003; 750-669/000-003			Item: 75x-663/000-003	
Parameter	Min.	Typ. (24 V)	Max.	Min.	Typ. (24 V)	Max.
Test pulse duration $t_i$	2 ms	-	200 ms	2 ms	-	200 ms
Test pulse interval T	18 ms	42 ms	1230 ms	18 ms	42 ms	1230 ms
Input resistance R	-	3.6 k $\Omega$	8.5 k $\Omega$	-	2.4 k $\Omega$	8.5 k $\Omega$
Input capacitance $C_L$	-	-	12 nF	-	-	12 nF
Inductance $L_L$	-	-	-	-	-	-
Additional measure "M"	• Parameterize filter time to at least 2 ms • Deactivate short circuit test			• Parameterize filter time to at least 2 ms • Deactivate short circuit test		

Interface Type C – Sink, Class C2		Item: 75x-661/000-003; 75x-662/000-003; 75x-666/000-003; 75x-667/000-003; 750-669/000-003			Item: 75x-663/000-003	
Parameter	Min.	Typ. (24 V)	Max.	Min.	Typ. (24 V)	Max.
Test pulse duration $t_i$	1 ms	-	200 ms	1 ms	-	200 ms
Test pulse interval T	18 ms	42 ms	1230 ms	18 ms	42 ms	1230 ms
Input resistance R	-	3.6 k $\Omega$	8.5 k $\Omega$	-	2.4 k $\Omega$	8.5 k $\Omega$
Input capacitance $C_L$	-	-	12 nF	-	-	12 nF
Inductance $L_L$	-	-	-	-	-	-
Additional measure "M"	• Parameterize filter time to at least 1 ms • Deactivate short circuit test			• Parameterize filter time to at least 1 ms • Deactivate short circuit test		

Interface Type C – Sink, Class C3		Item: 75x-661/000-003; 75x-662/000-003; 75x-666/000-003; 75x-667/000-003; 750-669/000-003			Item: 75x-663/000-003	
Parameter	Min.	Typ. (24 V)	Max.	Min.	Typ. (24 V)	Max.
Test pulse duration $t_i$	0.5 ms	-	200 ms	0.5 ms	-	200 ms
Test pulse interval T	18 ms	42 ms	1230 ms	18 ms	42 ms	1230 ms
Input resistance R	-	3.6 k $\Omega$	8.5 k $\Omega$	-	2.4 k $\Omega$	8.5 k $\Omega$
Input capacitance $C_L$	-	-	12 nF	-	-	12 nF
Inductance $L_L$	-	-	-	-	-	-
Additional measure "M"	• Parameterize filter time to at least 0.5 ms • Deactivate short circuit test			• Parameterize filter time to at least 0.5 ms • Deactivate short circuit test		

## Classification of Binary 24 V Interfaces with Testing in the Field of Functional Safety per ZVEI Position Paper CB24I

Interface Type A – Source		Item: 750-669/000-003		
Parameter	Min.	Typ.	Max.	
Switching current $I_i$	3 mA	-	6 A per contact	
Switching voltage $U_i$	10 V	-	60 VDC / 48 VAC	
Internal resistance $R_i$ (in the switched state)	-	-	100 mΩ	
Load capacitance $C_L$	-	-	-	
Load inductance $L_L$	-	-	1.2 H	
Potential-free	Yes			

Interface Type C – Source, Class C0		Item: 75x-666/000-003			Item: 75x-667/000-003		
Parameter	Min.	Typ.	Max.	Min.	Typ.	Max.	
Test pulse duration $t_i$	2 ms	-	500 ms	1 ms	-	500 ms	
Leakage current $I_{Leakage}$ of the output in the OFF state	-	-	<1 mA	-	-	1.2 mA	
Nominal current $I_N$ of the output in the ON state	-	-	10 A	20 mA	2 A	2.4 A	
Capacitive load $C_L$	-	-	10,000 μF	-	-	2.2 μF	
Inductive load $L_L$	-	-	1.2 H	-	-	1.2 H	
Additional measure "M"	<ul style="list-style-type: none"> <li>Parameterize test pulse duration</li> <li>Parameterize output tolerance time</li> </ul>			<ul style="list-style-type: none"> <li>Parameterize test pulse duration</li> </ul>			

Interface Type D – Source, Class D0		Item: 75x-666/000-003			Item: 75x-667/000-003		
Parameter	Min.	Typ.	Max.	Min.	Typ.	Max.	
Test pulse duration $t_i$	2 ms	-	500 ms	1 ms	-	500 ms	
Leakage current $I_{Leakage}$ of the output in the OFF state	-	-	<1 mA	-	-	1.2 mA	
Nominal current $I_N$ of the output in the ON state	-	-	10 A	20 mA	2 A	2.4 A	
Capacitive load $C_L$	-	-	10,000 μF	-	-	2.2 μF	
Inductive load $L_L$	-	-	1.2 H	-	-	1.2 H	
Additional measure "M"	<ul style="list-style-type: none"> <li>Parameterize test pulse duration</li> <li>Parameterize output tolerance time</li> </ul>			<ul style="list-style-type: none"> <li>Parameterize test pulse duration</li> </ul>			

Interface Type D – Source, Class D1		Item: 75x-667/000-003		
Parameter	Min.	Typ.	Max.	
Test pulse duration $t_i$	-	-	1 ms	
Leakage current $I_{Leakage}$ of the output in the OFF state	-	-	1.2 mA	
Nominal current $I_N$ of the output in the ON state	20 mA	2 A	2.4 A	
Capacitive load $C_L$	-	-	2.2 μF	
Inductive load $L_L$	-	-	1.2 H	
Additional measure "M"	<ul style="list-style-type: none"> <li>Parameterize test pulse duration to 1 ms</li> </ul>			

Interface Type D – Source, Class D1, D2, D3		Item: 75x-666/000-003			Item: 75x-667/000-003		
Parameter	Min.	Typ.	Max.	Min.	Typ.	Max.	
Test pulse duration $t_i$	-	-	-	-	-	-	
Leakage current $I_{Leakage}$ of the output in the OFF state	-	-	<1 mA	-	-	1.2 mA	
Nominal current $I_N$ of the output in the ON state	20 mA	2 A	10 A	20 mA	2 A	2.4 A	
Capacitive load $C_L$	-	-	10,000 μF	-	-	2.2 μF	
Inductive load $L_L$	-	-	1.2 H	-	-	1.2 H	
Additional measure "M"	<ul style="list-style-type: none"> <li>Parameterize test pulse duration to 0 ms (off)</li> <li>Parameterize output tolerance time</li> <li>Program safety application for automatic test: Switch off the output once every 8 h</li> <li>Parameterize output configuration</li> </ul>			<ul style="list-style-type: none"> <li>Parameterize test pulse duration to 0 ms (off)</li> <li>Program safety application for automatic test: Switch off the output once every 8 h</li> </ul>			

## Fail-Safe Digital Input or Digital Input/Output; 24 VDC; PROFIsafe

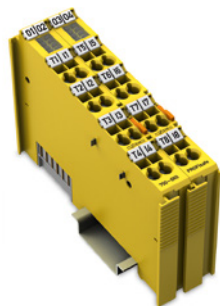
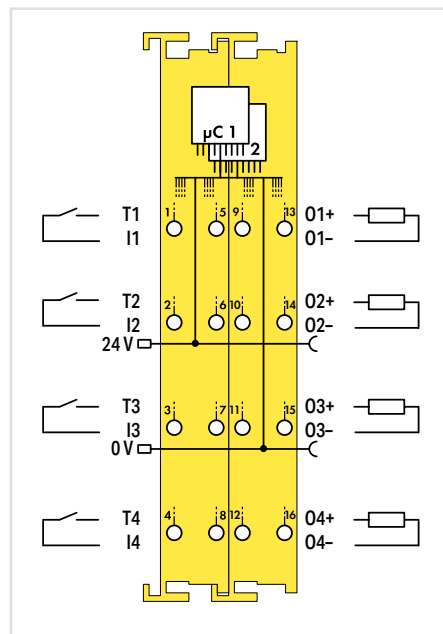
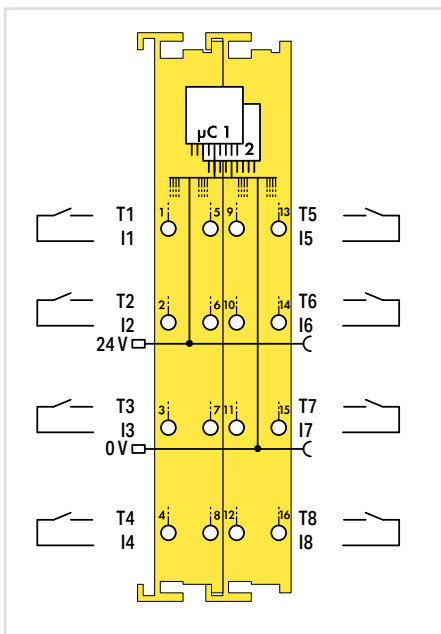


Figure: 750-660/000-001



Figure: 750-665/000-001



5.8

Item Description	Fail-Safe Digital Input, 8 Channels; 24 VDC; PROFIsafe	Fail-Safe Digital Input/Output, 4/4 Channels; 24 VDC; 0.5 A; PROFIsafe
Version	Standard	Standard
Item No.	750-660/000-001	750-665/000-001
Order Text	8FDI; 24 VDC; PROFIsafe	4FDI/4FDO; 24 VDC; 0.5A; PROFIsafe
<b>Technical Data</b>		
Number of digital inputs	8	4
Achievable safety classes	8 x Cat. 2/SIL 2 or 4 x Cat. 4/SIL 3	4 x Cat. 2/SIL 2 or 2 x Cat. 4/SIL 3
Protocol	PROFIsafe V1.3	PROFIsafe V1.3
Configuration options	PROFIsafe address adjustable via DIP switch or engineering software	PROFIsafe address adjustable via DIP switch or engineering software
Sensor connection	Fail-safe input with test pulse	Fail-safe input with test pulse
Input characteristic	Clock sensitive	Clock sensitive
Input current per channel for signal (1) typ.	2.2 mA	2.2 mA
Number of digital outputs		4
Output circuit design		Power outputs
Actuator connection		Fail-safe output with test pulse
Switching frequency (max.) with load type		5 Hz, ohmic load; 0.1 Hz, inductive load per IEC 947-5-1, DC 13; 5 Hz, inductive load per IEC 947-5-1, DC 13, with recovery diodes
Supply voltage (field)	24 VDC (-15 ... +20 %); via power jumper contacts (power supply via blade contact; transmission via spring contact)	24 VDC (-15 ... +20 %); via power jumper contacts (power supply via blade contact; transmission via spring contact)
Proof test interval	10 years	10 years
Supply voltage (system)	5 VDC; via data contacts	5 VDC; via data contacts
Current consumption – system supply (5 V)	40 mA	55 mA
Surrounding air temperature (operation)	0 ... +55 °C	0 ... +55 °C
Dimensions W x H x D	24 x 70.9 x 100 mm	24 x 70.9 x 100 mm
<b>Safety Standards</b>	IEC 61508, parts 1-7, 1998 and 2000; EN 954-1 Cat. 4	IEC 61508, parts 1-7, 1998 and 2000; EN 954-1 Cat. 4
<b>Approvals</b>	CE; UL; OrdLoc/HazLoc; ATEX/IECEx	CE; UL; OrdLoc/HazLoc; ATEX/IECEx
Data sheet and further information, see:	wago.com/750-660/000-001	wago.com/750-665/000-001

„ Mini-WSB marker card and mounting accessories, see Section "Accessories and Tools"

„ Approvals and corresponding ratings, see page 522 or www.wago.com

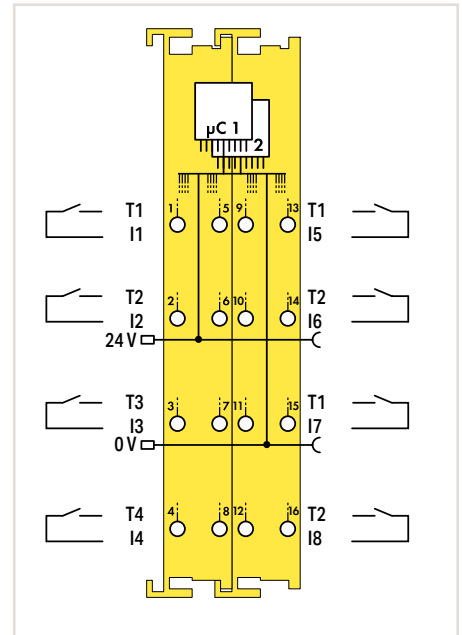
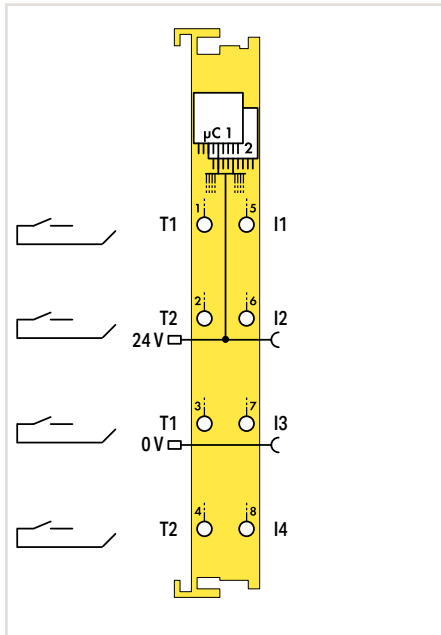


### Fail-Safe Digital Input; 24 VDC; PROFIsafe V 2.0 iPar



Figure: 750-661/000-003

Figure: 750-662/000-003



Item Description	Fail-Safe Digital Input, 4 Channels; 24 VDC; PROFIsafe V 2.0 iPar		Fail-Safe Digital Input, 8 Channels; 24 VDC; PROFIsafe V 2.0 iPar	
Version	Standard	Pluggable (delivery without connector)	Standard	Pluggable (delivery without connector)
Item No.	750-661/000-003	753-661/000-003	750-662/000-003	753-662/000-003
Order Text	4FDI; 24 VDC; PROFIsafe V2 iPar		8FDI; 24 VDC; PROFIsafe V2 iPar	
<b>Technical Data</b>				
Pluggable connector	•		•	
Number of digital inputs	4		8	
Achievable safety classes	SIL 3; Cat. 4, PL e		SIL 3; Cat. 4, PL e	
Protocol	PROFIsafe V2		PROFIsafe V2	
Configuration options	PROFIsafe address adjustable via DIP switch or engineering software		PROFIsafe address adjustable via DIP switch or engineering software	
Sensor connection	Fail-safe input with test pulse		Fail-safe input with test pulse	
Input characteristic	Clock sensitive		Clock sensitive	
Input current per channel for signal (1) typ.	2.2 mA		2.2 mA	
Input characteristic	Type 1		Type 1	
Signal frequency (max.)	50 Hz		50 Hz	
Supply voltage (field)	24 VDC (-15 ... +20 %); via power jumper contacts (power supply via blade contact; transmission via spring contact)		24 VDC (-15 ... +20 %); via power jumper contacts (power supply via blade contact; transmission via spring contact)	
Supply voltage (system)	5 VDC; via data contacts		5 VDC; via data contacts	
Current consumption – system supply (5 V)	145 mA		148 mA	
Surrounding air temperature (operation)	0 ... +55 °C		0 ... +55 °C	
Dimensions W x H x D	24 x 70.9 x 100 mm		24 x 70.9 x 100 mm	
<b>Safety Standards</b>	IEC 61508, Parts 1-7, Edition 2: 2010; EN ISO 13849-1: 2008 + AC: 2009; EN 62061		IEC 61508, Parts 1-7, Edition 2: 2010; EN ISO 13849-1: 2008 + AC: 2009; EN 62061	
<b>Approvals</b>	CE;  Marine;  OrdLoc/HazLoc;  ATEX/IECEX		CE;  Marine;  OrdLoc/HazLoc;  ATEX/IECEX	
Data sheet and further information, see:	<a href="http://wago.com/750-661/000-003">wago.com/ 750-661/000-003</a>	<a href="http://wago.com/753-661/000-003">wago.com/ 753-661/000-003</a>	<a href="http://wago.com/750-662/000-003">wago.com/ 750-662/000-003</a>	<a href="http://wago.com/753-662/000-003">wago.com/ 753-662/000-003</a>
<b>Accessories</b>				
Pluggable connector, safety	Item No. 753-120		Item No. 753-120	
Coding keys	753-150		753-150	

Support for iPar servers allows automatic parameter restoration when replacing an I/O module.

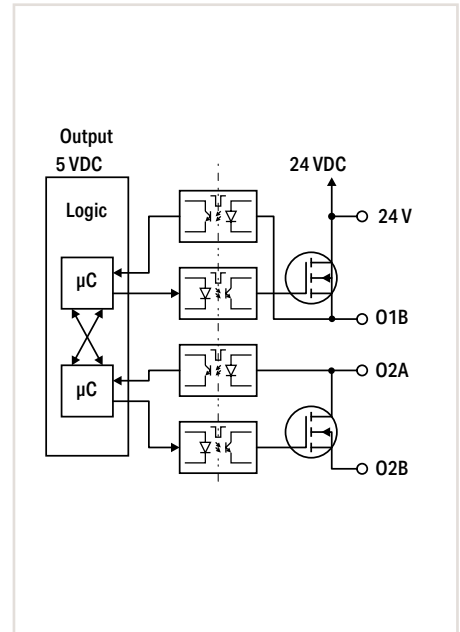
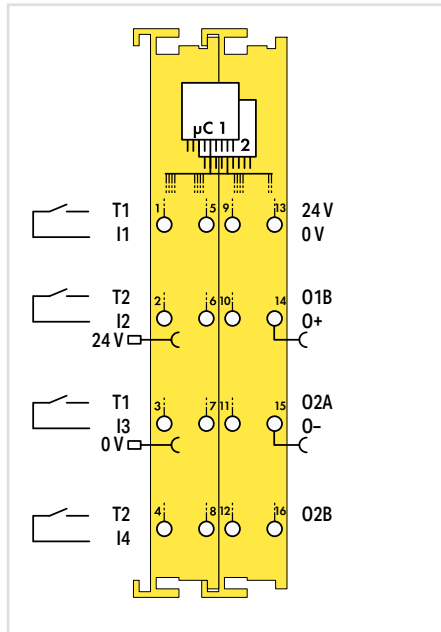
## Fail-Safe Digital Input/Output, 4/2 Channels; 24 VDC; 10 A; PROFIsafe V 2.0 iPar



Figure: 750-666/000-003



Figure: 753-666/000-003



5.8

Item Description	Fail-Safe Digital Input/Output, 4/2 Channels; 24 VDC; 10 A; PROFIsafe V 2.0 iPar	
Version	Standard	Pluggable (delivery without connector)
Item No.	750-666/000-003	753-666/000-003
Order Text	4FDI/2FDO; 24 VDC; 10A; PROFIsafe V2 iPar	4FDI/2FDO; 24 VDC; 10A; PROFIsafe V2 iPar
<b>Technical Data</b>		
Pluggable connector	●	
Number of digital inputs	4	
Achievable safety classes	SIL 3; Cat. 4, PL e	
Protocol	PROFIsafe V2	
Configuration options	PROFIsafe address adjustable via DIP switch or engineering software	
Sensor connection	Fail-safe input with test pulse	
Input characteristic	Clock sensitive	
Input current per channel for signal (1) typ.	2.2 mA	
Signal frequency (max.)	50 Hz	
Number of digital outputs	2	
Output circuit design	Power outputs	
Actuator connection	2 x (fail-safe output with test pulse)	
Output current per channel	10 A	
Output current (module) max.	20 A (single operation)	
Protection against incorrect wiring	Short-circuit-protected	
Switching frequency (max.) with load type	50 Hz, ohmic load; 0.1 Hz, inductive load	
Supply voltage (field)	24 VDC (-15 ... +20 %); via power jumper contacts (power supply via blade contact; transmission via spring contact)	
Supply voltage (system)	5 VDC; via data contacts	
Current consumption – system supply (5 V)	190 mA	
Surrounding air temperature (operation)	0 ... +55 °C	
Dimensions W x H x D	24 x 70.9 x 100 mm	
<b>Safety Standards</b>	IEC 61508, Parts 1-7, Edition 2: 2010; EN ISO 13849-1: 2008 + AC: 2009; EN 62061	
<b>Approvals</b>	CE,  Marine,  OrdLoc/HazLoc;  ATEX/IECEx	
<b>Data sheet and further information, see:</b>	<a href="http://wago.com/750-666/000-003">wago.com/750-666/000-003</a>	<a href="http://wago.com/753-666/000-003">wago.com/753-666/000-003</a>
<b>Accessories</b>		
Pluggable connector, safety	Item No. 753-120	
Coding keys	753-150	
„ Approvals and corresponding ratings, see page 522 or <a href="http://www.wago.com">www.wago.com</a>		

This module enables a fail-safe 2-channel switch-off (single failure protection) when the power outputs are used in a bipolar configuration. If a fail-safe 1-channel switch-off is adequate, two independent switching channels are available. The module is capable of safely shutting off the supply voltage of entire actuator groups which are connected to the standard modules arranged to the right. The 2-channel circuit types P-M and P-P as well as the 1-channel circuit types P, P or P, M are available.

Support for iPar servers allows automatic parameter restoration when replacing an I/O module.

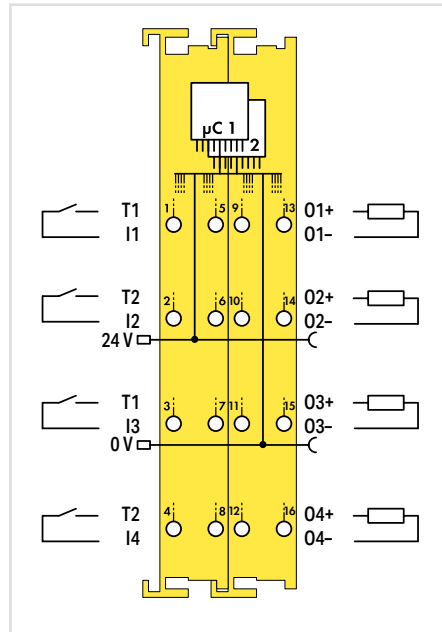
## Fail-Safe Digital Input/Output, 4/4 Channels; 24 VDC; 2 A; PROFIsafe V 2.0 iPar



Figure: 750-667/000-003



Figure: 753-667/000-003



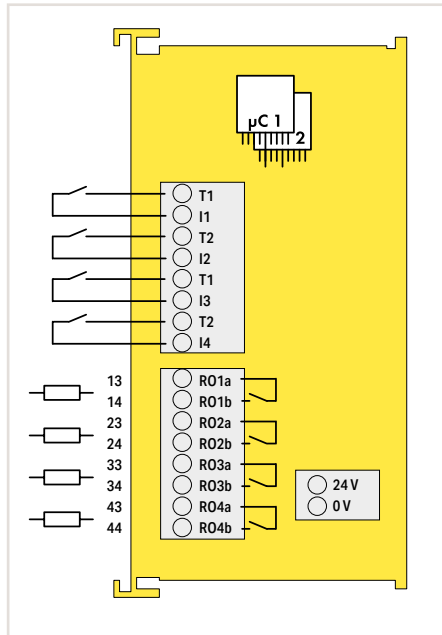
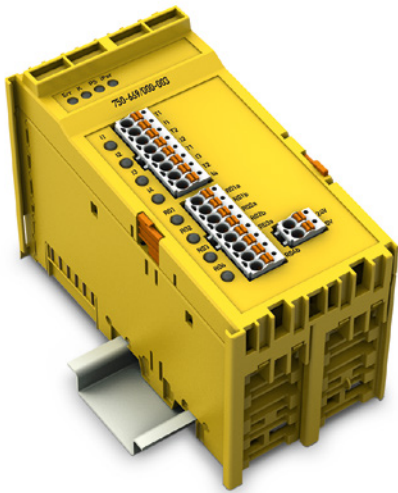
Item Description	Fail-Safe Digital Input/Output, 4/4 Channels; 24 VDC; 2 A; PROFIsafe V 2.0 iPar	
Version	Standard	Pluggable (delivery without connector)
Item No.	750-667/000-003	753-667/000-003
Order Text	4FDI/4FDO; 24 VDC; 2A; PROFIsafe V2 iPar	4FDI/4FDO; 24 VDC; 2A; PROFIsafe V2 iPar
<b>Technical Data</b>		
Pluggable connector	●	
Number of digital inputs	4	
Achievable safety classes	SIL 3; Cat. 4, PL e	
Protocol	PROFIsafe V2	
Configuration options	PROFIsafe address adjustable via DIP switch or engineering software	
Sensor connection	Fail-safe input with test pulse	
Input characteristic	Clock sensitive	
Input current per channel for signal (1) typ.	2.2 mA	
Signal frequency (max.)	50 Hz	
Number of digital outputs	4	
Output circuit design	Power outputs	
Actuator connection	4 x (fail-safe output with test pulse)	
Output current per channel	2 A	
Output current (module) max.	8 A	
Protection against incorrect wiring	Short-circuit-protected	
Switching frequency (max.) with load type	50 Hz, ohmic load; 0.1 Hz, inductive load	
Supply voltage (field)	24 VDC (-15 ... +20 %); via power jumper contacts (power supply via blade contact; transmission via spring contact)	
Supply voltage (system)	5 VDC; via data contacts	
Current consumption – system supply (5 V)	180 mA	
Surrounding air temperature (operation)	0 ... +55 °C	
Dimensions W x H x D	24 x 70.9 x 100 mm	
<b>Safety Standards</b>	IEC 61508, Parts 1-7, Edition 2: 2010; EN ISO 13849-1: 2008 + AC: 2009; EN 62061	
<b>Approvals</b>	CE;  Marine;  OrdLoc/HazLoc;  ATEX/IECEx	
Data sheet and further information, see:	<a href="http://wago.com/750-667/000-003">wago.com/ 750-667/000-003</a>	<a href="http://wago.com/753-667/000-003">wago.com/ 753-667/000-003</a>
<b>Accessories</b>		
Pluggable connector, safety	Item No. 753-120	
Coding keys	753-150	

The 2-channel circuit types P-M and P-P as well as the 1-channel circuit types P, P or P, M are available at each output. When two 1-channel P circuits are used, Categories 4/PL e or SIL3 are possible.

Support for iPar servers allows automatic parameter restoration when replacing an I/O module.

5.8

# Fail-Safe Digital Input/Relay Output, 4/4 Channels; 48 VAC/60 VDC; 6 A; PROFIsafe V 2.0 iPar



Support for iPar servers allows automatic parameter restoration when replacing an I/O module.

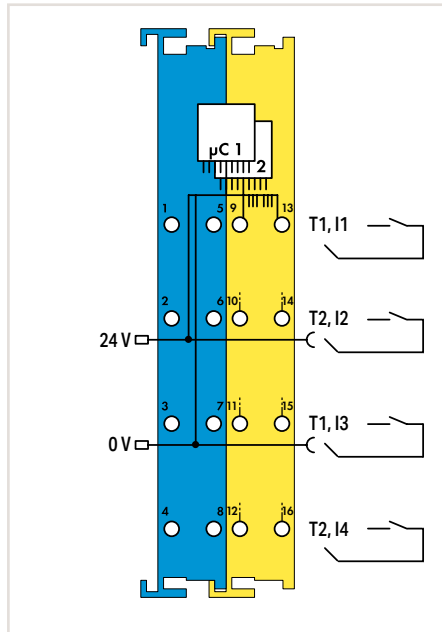
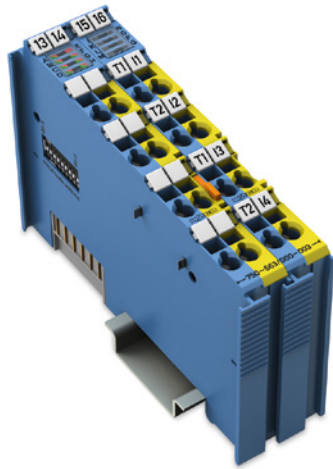
5.8

<b>Item Description</b>	<b>Fail-Safe Digital Input/Relay Output, 4/4 Channels; 48 VAC/60 VDC; 6 A; PROFIsafe V 2.0 iPar</b>
<b>Item No.</b>	<b>750-669/000-003</b>
<b>Order Text</b>	4FDI/4FRO; 48VAC/ 60VDC; 6A; PROFIsafe V2 iPar

Technical Data	
Number of digital inputs	4
Achievable safety classes	SIL 3; Cat. 4, PL e
Protocol	PROFIsafe V2
Configuration options	PROFIsafe address adjustable via DIP switch or engineering software
Sensor connection	4 x (fail-safe input with test pulse)
Input characteristic	Clock sensitive
Input current per channel for signal (1) typ.	2.2 mA
Input characteristic	Type 1
Signal frequency (max.)	50 Hz
Number of digital outputs	4
Output circuit design	Relay outputs
Actuator connection	4 x (fail-safe output with test pulse)
Load switching voltage range	5 ... 60 VDC (SELV/PELV); 5 ... 48 VAC
Isolation voltage	Relay outputs: 48 VAC; 60 VDC
Switching current (min.)	3 mA
Output current per channel	6 A
Output current (module) max.	24 A
Switching delay	50 ms
Supply voltage (field)	24 VDC via wiring level (push-in CAGE CLAMP® connector)
Supply voltage (system)	5 VDC; via data contacts
Current consumption – system supply (5 V)	120 mA
Surrounding air temperature (operation)	0 ... +55 °C
Dimensions W x H x D	24 x 70.9 x 100 mm
<b>Safety Standards</b>	IEC 61508, Parts 1-7, Edition 2: 2010; EN ISO 13849-1: 2008 + AC: 2009; EN 62061
<b>Approvals</b>	CE, TÜV
<b>Data sheet and further information, see:</b>	<a href="http://wago.com/750-669/000-003">wago.com/750-669/000-003</a>

„ Mini-WSB marker card and mounting accessories, see Section "Accessories and Tools"  
 „ Approvals and corresponding ratings, see page 522 or [www.wago.com](http://www.wago.com)

# Intrinsically Safe 4-Channel Digital Input; 24 VDC; PROFIsafe V 2.0 iPar



<b>Item Description</b>
<b>Item No.</b>
<b>Order Text</b>
<b>Technical Data</b>
Protocol
Configuration options
Sensor inputs
Input current (typ.)
Input frequency (max.)
Input filter (digital)
Clock outputs
Supply voltage (field)
Current consumption, field supply (module with no external load)
Current consumption – system supply (5 V)
Isolation
Surrounding air temperature (operation)
Dimensions W x H x D
<b>Functional Safety</b>
Achievable risk reduction
Safety standards
<b>Explosion Protection</b>
Safety-relevant data (circuit)
Reactances Ex ia IIC
Reactances Ex ia IIB
Reactances Ex ia IIA
Reactances Ex ia I
<b>Ex guideline</b>
<b>Approvals</b>
<b>Marking</b>
<b>Data sheet and further information, see:</b>

<b>Intrinsically Safe 4-Channel Digital Input; 24 VDC; PROFIsafe V 2.0 iPar</b>
<b>750-663/000-003</b>
4F-Ex i DI; 24 VDC; PROFIsafe V2 iPar
PROFIsafe V2
PROFIsafe address adjustable via DIP switch or engineering software
I4; clock sensitive to T1 ... T2
3 mA
50 Hz
0 ... 200 ms, parameterizable in steps
2
24 VDC (Ex i power supply: $U_o = \text{max. } 27.3 \text{ V}$ ); via power jumper contacts (power supply via blade contact; transmission via spring contact)
20 mA
145 mA
$U_m = 375 \text{ V}$ system/supply
0 ... +55 °C
24 x 67.8 x 100 mm
SIL 3 per IEC 61508:2010; SIL 3 per IEC 61511:2005; SIL 3 per IEC 62061:2005; Cat. 4, PL e per EN ISO 13849:2008
IEC 61508; IEC 62061; EN ISO 13849; IEC 61511
$U_o = 27.3 \text{ V}$ ; $I_o = 23 \text{ mA}$ ; $P_o = 157 \text{ mW}$ ; Linear characteristic curve
$L_o = 61 \text{ mH}$ ; $C_o = 64 \text{ nF}$
$L_o = 100 \text{ mH}$ ; $C_o = 552 \text{ nF}$
$L_o = 100 \text{ mH}$ ; $C_o = 2.28 \text{ }\mu\text{F}$
$L_o = 100 \text{ mH}$ ; $C_o = 2.95 \text{ }\mu\text{F}$
EN IEC 60079-0, -7, -11
CE;  Marine;  OrdLoc/HazLoc/AEx; ATEX/IECEx; INMETRO
ATEX/IECEx: II 3 (1) G Ex ec [ia Ga] IIC T4 Gc II (1) D [Ex ia Da] IIC I (M1) [Ex ia Ma] I
<a href="http://wago.com/750-663/000-003">wago.com/750-663/000-003</a>

This module combines intrinsic safety with functional safety and was specifically developed for reliable acquisition from potential-free, contact-based emergency stop switches, safety interlock switches, mode selectors and safety sensors that are located in hazardous environments. Thus, safety functions with fail-safe sensors from Ex Zones 0 and 1 can be implemented. Support for iPar servers allows automatic parameter restoration when replacing an I/O module.

Reactances without accounting for the concurrence of capacitance ( $C_o$ ) and inductance ( $L_o$ )

# Intrinsically Safe Modules Ex i

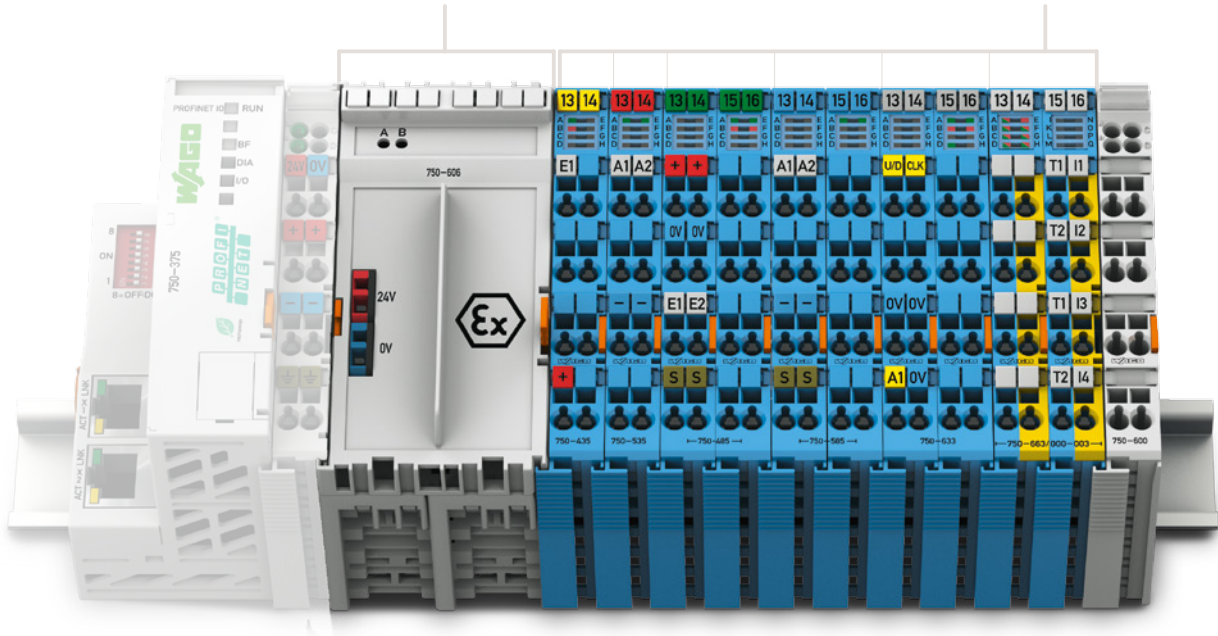


## Specialty Housing

Dimensions W x H x D	48 x 70.9 x 100
Height from upper-edge of DIN-rail	63.7 mm
Connection technology	CAGE CLAMP®
Conductor cross section	0.08 ... 1.5 mm <sup>2</sup> / 28 ... 16 AWG
Strip length	5 ... 6 mm / 0.22 inch

## Housing Design (750 Series)

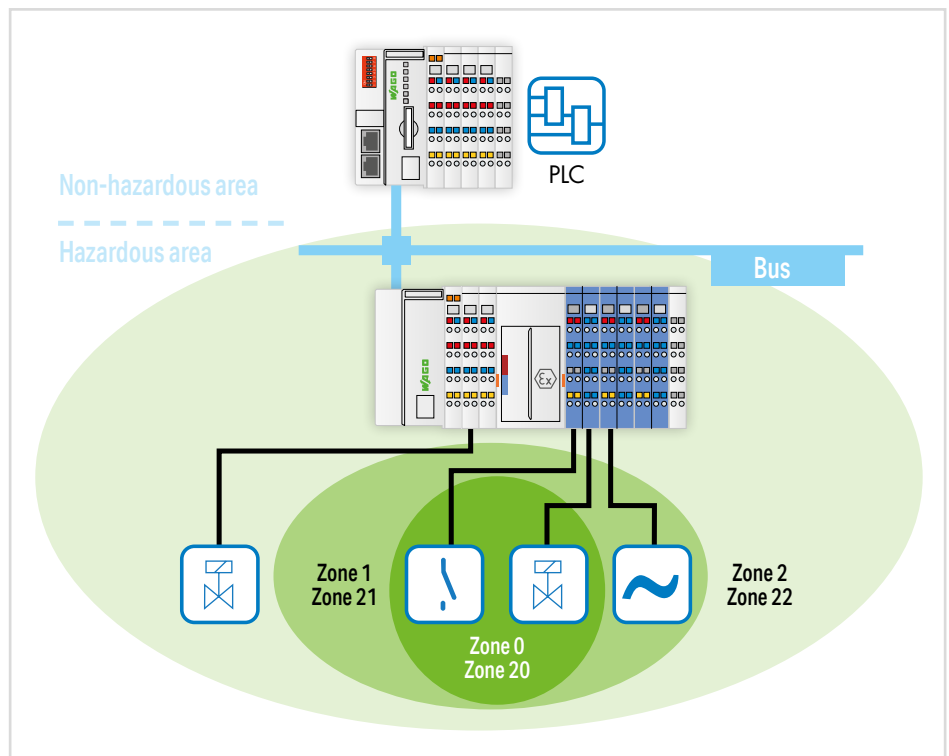
Dimensions W x H x D	12 or 24 x 67.8 x 100 mm
Height from upper-edge of DIN-rail	60.6 mm
Connection technology	CAGE CLAMP®
Conductor cross section	0.08 ... 2.5 mm <sup>2</sup> / 28 ... 14 AWG
Strip length	8 ... 9 mm / 0.33 inch



## Use in Hazardous Areas

In many plants across the chemical and petrochemical industries, as well as in the production and process automation sectors, installations are operated that process explosive gas- or dust-air mixtures. This is why electrical equipment must be explosion-proof in order to avoid injuries to personnel and damage to equipment.

The modules within the WAGO-I/O-SYSTEM 750 are designed for use in both non-hazardous and hazardous areas. The direct application of fieldbus technology in potentially explosive areas is typically resource-intensive. When used in hazardous areas of Zone 2/22, the WAGO-I/O-SYSTEM 750 offers a safe, easy and economical connection to the sensors and actuators of Zones 0/20 and 1/21. The "blue" Ex i I/O modules were specially developed for this purpose. They form an intrinsically safe section that can be integrated into a standard fieldbus node, offering all the advantages of state-of-the-art fieldbus technology. The WAGO-I/O-SYSTEM 750 is also approved for mining applications.

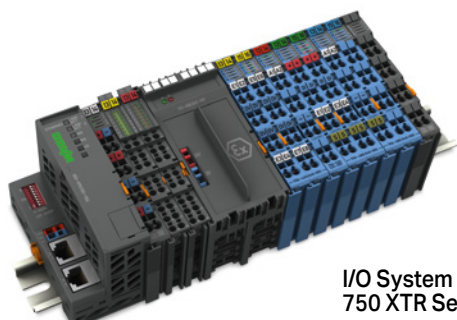


## I/O System – 750 and 753 Series; Intrinsically Safe Modules Ex i

### Contents

Function	Description	Item Number	Page
Power Supplies Ex i	Power Supply; 24 VDC; Diagnostics; Intrinsically safe	750-606*	310
	Power Supply; 24 VDC; Intrinsically safe	750-625/000-001	310
Digital Inputs Ex i for Proximity Sensors per EN 60947-5-6	1-Channel Digital Input; NAMUR; Intrinsically safe	750-435	311
	2-Channel Digital Input; NAMUR; Intrinsically safe	750-438	311
	Intrinsically Safe 4-Channel Digital Input; 24 VDC; PROFIsafe V 2.0 iPar	750-663/000-003	312
	8-Channel Digital Input; NAMUR; Intrinsically safe	750-439*	313
Digital Outputs Ex i	2-Channel Digital Output; 24 VDC; Intrinsically safe	750-535*	314
	4-Channel Digital Output; 24 VDC; Valve; Intrinsically safe	750-539	314
	2-Channel Relay Output; Changeover contact; Potential-free; Intrinsically safe	750-538	315
Analog Inputs Ex i	2-Channel Analog Input; 4 ... 20 mA; Intrinsically safe	750-485	316
	4-Channel Analog Input; 0/4 ... 20 mA; NAMUR NE43; Intrinsically safe	750-486*	316
	2-Channel Analog Input; 4 ... 20 mA HART; Intrinsically safe	750-484*	317
	2-Channel Analog Input; 4 ... 20 mA HART; NAMUR NE43; Intrinsically safe	750-484/000-001	317
	2-Channel Analog Input; RTD; Intrinsically safe	750-481/003-000*	318
	2-Channel Analog Input; TC; Intrinsically safe	750-487/003-000	318
Analog Outputs Ex i	2-Channel Analog Output; 0 ... 20 mA; Intrinsically safe	750-585*	319
	2-Channel Analog Output; 4 ... 20 mA; Intrinsically safe	750-586	319
Function Module Ex i	Up/Down Counter; Intrinsically safe	750-633*	320
*This module is also available as a variant of the 750 XTR Series.		See Section 6	

5.9  
Ex i



I/O System –  
750 XTR Series

## Power Supply; Ex i

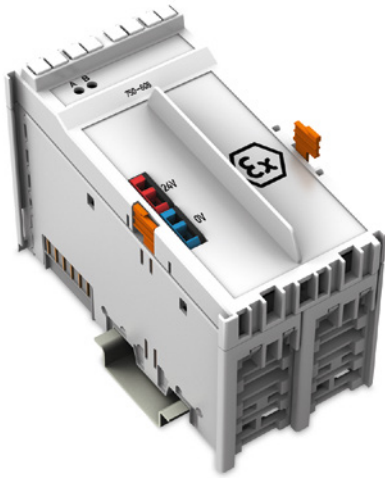
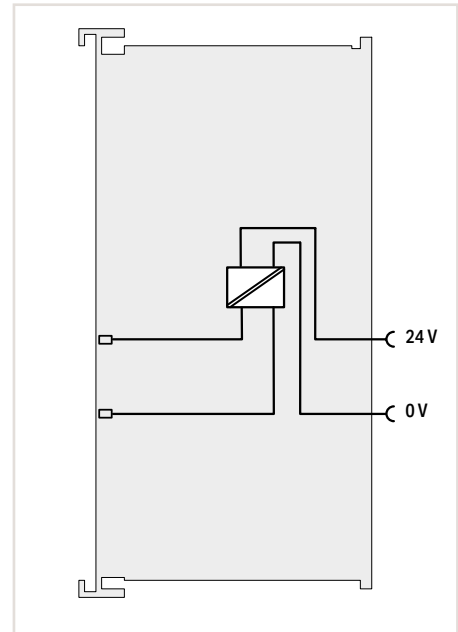
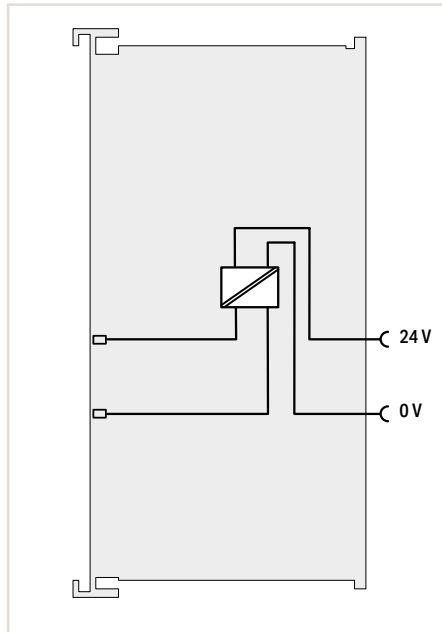


Figure: 750-606



Item Description	Power Supply; 24 VDC; Diagnostics; Intrinsically safe	Power Supply; 24 VDC; Intrinsically safe
Item No.	750-606	750-625/000-001
Order Text	Power Supply; 24 VDC; Diagn; Ex i	Power Supply; 24 VDC; Ex i
<b>Technical Data</b>		
Current consumption – system supply (5 V)	7.5 mA	7.5 mA
Input voltage	24 VDC (-25 ... +30 %)	24 VDC (-25 ... +30 %)
Supply voltage (field)	24 VDC (adjacent Ex i modules are supplied with $U_o = \text{max. } 27.3 \text{ V}$ ); via power jumper contacts (power supply via CAGE CLAMP® connection; transmission via spring contact)	24 VDC (adjacent Ex i modules are supplied with $U_o = \text{max. } 27.3 \text{ V}$ ); via power jumper contacts (power supply via CAGE CLAMP® connection; transmission via spring contact)
Current carrying capacity (power jumper contacts)	1 ADC	1 ADC
Fuse	Electronic	Electronic
Data width	2 bits (input voltage failure, fuse triggered)	
Surrounding air temperature (operation)	0 ... +55 °C	0 ... +55 °C
Dimensions W x H x D	24 x 70.9 x 100 mm	24 x 70.9 x 100 mm
<b>Explosion Protection</b>		
Power supply (input)	$U_n = 24 \text{ VDC}$ ; $P_{\text{max}} = 29 \text{ W}$ ; $U_m = 253 \text{ V}$	$U_n = 24 \text{ VDC}$ ; $P_{\text{max}} = 29 \text{ W}$ ; $U_m = 253 \text{ V}$
Power supply (output)	$U_o = 27.3 \text{ V}$ (intrinsically safe output voltage per protection level ia); $I_n = 1 \text{ A}$	$U_o = 27.3 \text{ V}$ (intrinsically safe output voltage per protection level ia); $I_n = 1 \text{ A}$
<b>Ex guideline</b>	EN IEC 60079-0, -7, -11	EN IEC 60079-0, -7, -11
<b>Approvals</b>	CE;  Marine;  OrdLoc/HazLoc/AEx;  ATEX/IECEX; INMETRO	CE;  Marine;  OrdLoc/HazLoc/AEx;  ATEX/IECEX; INMETRO
<b>Marking</b>	ATEX/IECEX: II 3G Ex ec IIC T4 Gc	ATEX/IECEX: II 3G Ex ec IIC T4 Gc
<b>Data sheet and further information, see:</b>	<a href="http://wago.com/750-606">wago.com/750-606</a>	<a href="http://wago.com/750-625/000-001">wago.com/750-625/000-001</a>

The supply modules monitor the voltage supply of the downstream intrinsically safe segment and separate the intrinsically safe from the non-intrinsically safe section of the I/O system. The input and output sides are electrically isolated from each other.

Note: If, due to load conditions, more than one supply module is required per station, four spacer modules (750-616) must be placed between the intrinsically safe sections.

General information (e.g., installation regulations) on explosion protection is available in the WAGO-I/O-SYSTEM 750 manuals!

„ Mini-WSB marker card and mounting accessories, see Section "Accessories and Tools"

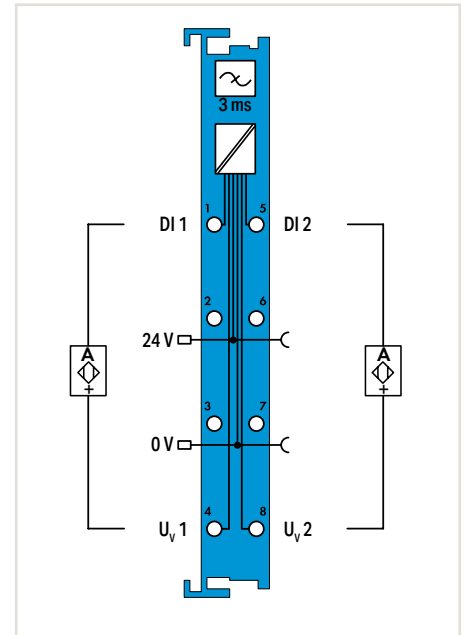
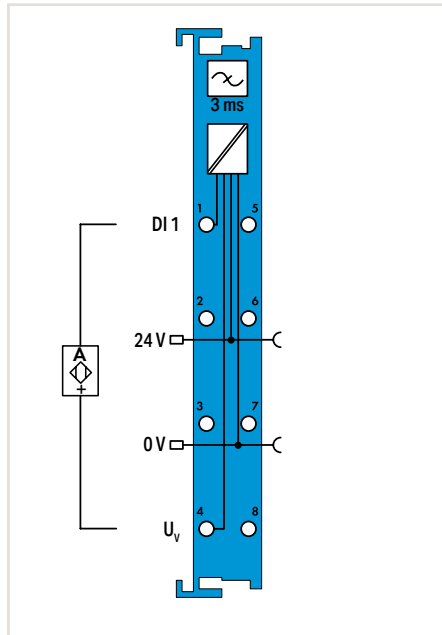
„ Approvals and corresponding ratings, see page 523, 518 or [www.wago.com](http://www.wago.com)



# Digital Input; NAMUR; Ex i

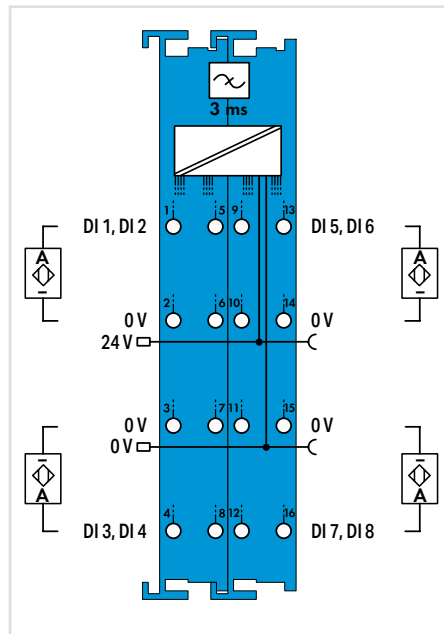


Figure: 750-435



Item Description	1-Channel Digital Input; NAMUR; Intrinsically safe	2-Channel Digital Input; NAMUR; Intrinsically safe
Item No.	750-435	750-438
Order Text	1DI; NAMUR; Ex i	2DI; NAMUR; Ex i
<b>Technical Data</b>		
Number of digital inputs	1	2
Signal type	NAMUR	NAMUR
Sensor connection	2-wire	2-wire
Input characteristic	High-side switching	High-side switching
Input filter (digital)	3 ms	3 ms
Open-circuit voltage	8.2 VDC	8.2 VDC
Diagnostics	Short circuit; wire break	-/-
Supply voltage (sensor)	8.2 VDC; short-circuit-protected; isolated channels	8.2 VDC; short-circuit-protected; isolated channels
Supply voltage (field)	24 VDC (Ex i power supply: $U_o = \text{max. } 27.3 \text{ V}$ ); via power jumper contacts (power supply via blade contact; transmission via spring contact)	24 VDC (Ex i power supply: $U_o = \text{max. } 27.3 \text{ V}$ ); via power jumper contacts (power supply via blade contact; transmission via spring contact)
Current consumption, field supply (module with no external load)	13 mA	16 mA
Current consumption – system supply (5 V)	2.5 mA	2.5 mA
Data width (internal)	2 bits	2 bits
Isolation	$U_m = 375 \text{ V system/supply}$	$U_m = 375 \text{ V system/supply}$
Surrounding air temperature (operation)	0 ... +55 °C	0 ... +55 °C
Dimensions W x H x D	12 x 67.8 x 100 mm	12 x 67.8 x 100 mm
<b>Explosion Protection</b>		
Safety-relevant data (circuit)	$U_o = 12 \text{ V}; I_o = 16 \text{ mA}; P_o = 48 \text{ mW};$ Linear characteristic curve	$U_o = 12 \text{ V}; I_o = 13.5 \text{ mA}; P_o = 40.5 \text{ mW};$ Linear characteristic curve
Reactances Ex ia IIC	$L_o = 180 \text{ mH}; C_o = 1.4 \mu\text{F}$	$L_o = 190 \text{ mH}; C_o = 1.4 \mu\text{F}$
Reactances Ex ia IIB	$L_o = 560 \text{ mH}; C_o = 9 \mu\text{F}$	$L_o = 600 \text{ mH}; C_o = 9 \mu\text{F}$
Reactances Ex ia IIA	$L_o = 900 \text{ mH}; C_o = 36 \mu\text{F}$	$L_o = 1 \text{ H}; C_o = 36 \mu\text{F}$
Reactances Ex ia I	$L_o = 1 \text{ H}; C_o = 38 \mu\text{F}$	$L_o = 1 \text{ H}; C_o = 38 \mu\text{F}$
Reactances	Reactances without accounting for the concurrence of capacitance ( $C_o$ ) and inductance ( $L_o$ ) EN IEC 60079-0, -7, -11	Reactances without accounting for the concurrence of capacitance ( $C_o$ ) and inductance ( $L_o$ ) EN IEC 60079-0, -7, -11
<b>Ex guideline</b>		
Approvals	CE; Marine; OrdLoc/HazLoc/AEx; ATEX/IECEX; INMETRO	CE; Marine; OrdLoc/HazLoc/AEx; ATEX/IECEX; INMETRO
<b>Marking</b>	ATEX/IECEX: II 3 (1) G Ex ec [ia Ga] IIC T4 Gc II (1) D [Ex ia Da] IIIC I (M1) [Ex ia Ma] I	ATEX/IECEX: II 3 (1) G Ex ec [ia Ga] IIC T4 Gc II (1) D [Ex ia Da] IIIC I (M1) [Ex ia Ma] I
Data sheet and further information, see:	wago.com/750-435	wago.com/750-438

## Digital Input; NAMUR; Ex i



### Item Description

8-Channel Digital Input; NAMUR;  
Intrinsically safe

### Item No.

750-439

### Order Text

8DI; NAMUR; Ex i

### Technical Data

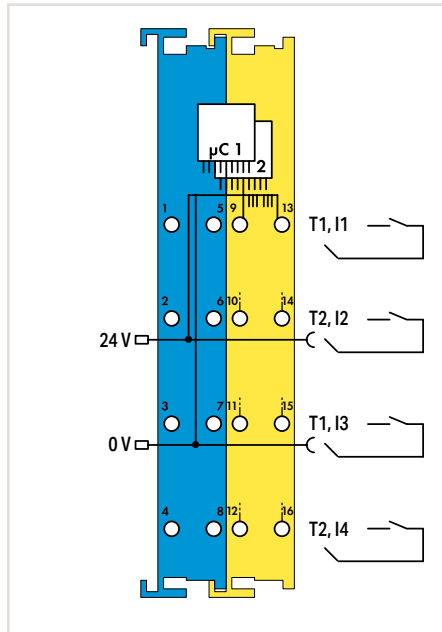
Number of digital inputs	8
Signal type	NAMUR
Sensor connection	2-wire
Input characteristic	High-side switching
Input filter (digital)	3 ms
Open-circuit voltage	8.2 VDC
Diagnostics	Short circuit; wire break (can be switched off)
Supply voltage (sensor)	8.2 VDC; short-circuit-protected; isolated channels
Supply voltage (field)	24 VDC (Ex i power supply: $U_o = \text{max. } 27.3 \text{ V}$ ); via power jumper contacts (power supply via blade contact; transmission via spring contact)
Current consumption, field supply (module with no external load)	11 mA
Current consumption – system supply (5 V)	56 mA
Data width (internal)	16 bits
Isolation	$U_m = 375 \text{ V system/supply}$
Surrounding air temperature (operation)	0 ... +55 °C
Dimensions W x H x D	24 x 67.8 x 100 mm
<b>Explosion Protection</b>	
Safety-relevant data (circuit)	$U_o = 11.76 \text{ V}$ ; $I_o = 12.4 \text{ mA}$ ; $P_o = 36.67 \text{ mW}$ ; Linear characteristic curve
Reactances Ex ia IIC	$L_o = 100 \text{ mH}$ ; $C_o = 1 \mu\text{F}$
Reactances Ex ia IIB	$L_o = 100 \text{ mH}$ ; $C_o = 9.9 \mu\text{F}$
Reactances Ex ia IIA	$L_o = 100 \text{ mH}$ ; $C_o = 39 \mu\text{F}$
Reactances Ex ia I	$L_o = 100 \text{ mH}$ ; $C_o = 30 \mu\text{F}$
Ex guideline	EN IEC 60079-0, -7, -11
Approvals	CE;  Marine;  OrdLoc/HazLoc/AEx; ATEX/IECEX; INMETRO
Marking	ATEX/IECEX: II 3 (1) G Ex ec [ia Ga] IIC T4 Gc II (1) D [Ex ia Da] IIC I (M1) [Ex ia Ma] I
Data sheet and further information, see:	<a href="http://wago.com/750-439">wago.com/750-439</a>

Reactances without accounting for the concurrence of capacitance ( $C_o$ ) and inductance ( $L_o$ )

„ Mini-WSB marker card and mounting accessories, see Section "Accessories and Tools"

„ Approvals and corresponding ratings, see page 518, 522 or [www.wago.com](http://www.wago.com)

# Intrinsically Safe 4-Channel Digital Input; 24 VDC; PROFIsafe V 2.0 iPar



<b>Item Description</b>	<b>Intrinsically Safe 4-Channel Digital Input; 24 VDC; PROFIsafe V 2.0 iPar</b>
<b>Item No.</b>	<b>750-663/000-003</b>
<b>Order Text</b>	4F-Ex i DI; 24 VDC; PROFIsafe V2 iPar
<b>Technical Data</b>	
Protocol	PROFIsafe V2
Configuration options	PROFIsafe address adjustable via DIP switch or engineering software
Sensor inputs	4; clock sensitive to T1 ... T2
Input current (typ.)	3 mA
Input frequency (max.)	50 Hz
Input filter (digital)	0 ... 200 ms (configurable in steps)
Clock outputs	2
Supply voltage (field)	24 VDC (Ex i power supply: $U_o = \text{max. } 27.3 \text{ V}$ ); via power jumper contacts (power supply via blade contact; transmission via spring contact)
Current consumption, field supply (module with no external load)	20 mA
Current consumption – system supply (5 V)	145 mA
Isolation	$U_m = 375 \text{ V}$ system/supply
Surrounding air temperature (operation)	0 ... +55 °C
Dimensions W x H x D	24 x 67.8 x 100 mm
<b>Functional Safety</b>	
Achievable risk reduction	SIL 3 per IEC 61508:2010; SIL 3 per IEC 61511:2005; SIL 3 per IEC 62061:2005; Cat. 4, PL e per EN ISO 13849:2008
Safety standards	IEC 61508; IEC 62061; EN ISO 13849; IEC 61511
<b>Explosion Protection</b>	
Safety-relevant data (circuit)	$U_o = 27.3 \text{ V}$ ; $I_o = 23 \text{ mA}$ ; $P_o = 157 \text{ mW}$ ; Linear characteristic curve
Reactances Ex ia IIC	$L_o = 61 \text{ mH}$ ; $C_o = 64 \text{ nF}$
Reactances Ex ia IIB	$L_o = 100 \text{ mH}$ ; $C_o = 552 \text{ nF}$
Reactances Ex ia IIA	$L_o = 100 \text{ mH}$ ; $C_o = 2.28 \text{ }\mu\text{F}$
Reactances Ex ia I	$L_o = 100 \text{ mH}$ ; $C_o = 2.95 \text{ }\mu\text{F}$
<b>Ex guideline</b>	EN IEC 60079-0, -7, -11
<b>Approvals</b>	CE;  Marine;  OrdLoc/HazLoc/AEx; ATEX/IECEx; INMETRO
<b>Marking</b>	ATEX/IECEx: II 3 (1) G Ex ec [ia Ga] IIC T4 Gc II (1) D [Ex ia Da] IIIC I (M1) [Ex ia Ma] I
<b>Data sheet and further information, see:</b>	<a href="http://wago.com/750-663/000-003">wago.com/750-663/000-003</a>

<b>Item Description</b>	<b>Intrinsically Safe 4-Channel Digital Input; 24 VDC; PROFIsafe V 2.0 iPar</b>
<b>Item No.</b>	<b>750-663/000-003</b>
<b>Order Text</b>	4F-Ex i DI; 24 VDC; PROFIsafe V2 iPar
<b>Technical Data</b>	
Protocol	PROFIsafe V2
Configuration options	PROFIsafe address adjustable via DIP switch or engineering software
Sensor inputs	4; clock sensitive to T1 ... T2
Input current (typ.)	3 mA
Input frequency (max.)	50 Hz
Input filter (digital)	0 ... 200 ms (configurable in steps)
Clock outputs	2
Supply voltage (field)	24 VDC (Ex i power supply: $U_o = \text{max. } 27.3 \text{ V}$ ); via power jumper contacts (power supply via blade contact; transmission via spring contact)
Current consumption, field supply (module with no external load)	20 mA
Current consumption – system supply (5 V)	145 mA
Isolation	$U_m = 375 \text{ V}$ system/supply
Surrounding air temperature (operation)	0 ... +55 °C
Dimensions W x H x D	24 x 67.8 x 100 mm
<b>Functional Safety</b>	
Achievable risk reduction	SIL 3 per IEC 61508:2010; SIL 3 per IEC 61511:2005; SIL 3 per IEC 62061:2005; Cat. 4, PL e per EN ISO 13849:2008
Safety standards	IEC 61508; IEC 62061; EN ISO 13849; IEC 61511
<b>Explosion Protection</b>	
Safety-relevant data (circuit)	$U_o = 27.3 \text{ V}$ ; $I_o = 23 \text{ mA}$ ; $P_o = 157 \text{ mW}$ ; Linear characteristic curve
Reactances Ex ia IIC	$L_o = 61 \text{ mH}$ ; $C_o = 64 \text{ nF}$
Reactances Ex ia IIB	$L_o = 100 \text{ mH}$ ; $C_o = 552 \text{ nF}$
Reactances Ex ia IIA	$L_o = 100 \text{ mH}$ ; $C_o = 2.28 \text{ }\mu\text{F}$
Reactances Ex ia I	$L_o = 100 \text{ mH}$ ; $C_o = 2.95 \text{ }\mu\text{F}$
<b>Ex guideline</b>	EN IEC 60079-0, -7, -11
<b>Approvals</b>	CE;  Marine;  OrdLoc/HazLoc/AEx; ATEX/IECEx; INMETRO
<b>Marking</b>	ATEX/IECEx: II 3 (1) G Ex ec [ia Ga] IIC T4 Gc II (1) D [Ex ia Da] IIIC I (M1) [Ex ia Ma] I
<b>Data sheet and further information, see:</b>	<a href="http://wago.com/750-663/000-003">wago.com/750-663/000-003</a>

This module combines intrinsic safety with functional safety and was specifically developed for reliable acquisition from potential-free, contact-based emergency stop switches, safety interlock switches, mode selectors and safety sensors that are located in hazardous environments. Thus, safety functions with fail-safe sensors from Ex Zones 0 and 1 can be implemented. Support for iPar servers allows automatic parameter restoration when replacing an I/O module.

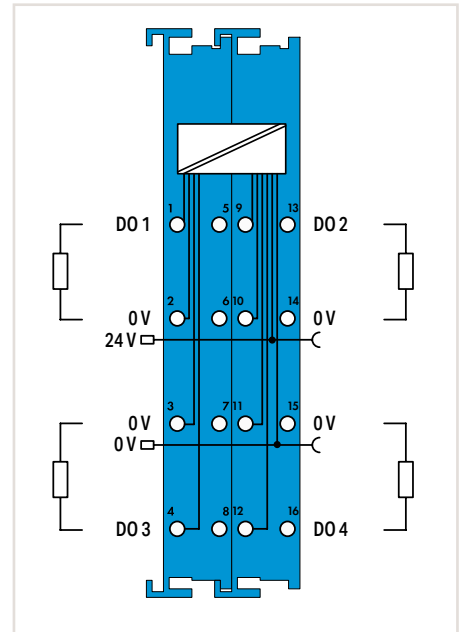
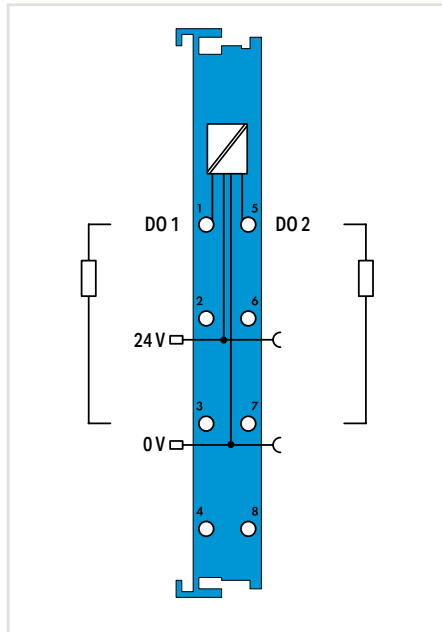
Reactances without accounting for the concurrence of capacitance ( $C_o$ ) and inductance ( $L_o$ )

## Digital Output; 24 VDC; Ex i



Figure: 750-535

Figure: 750-539

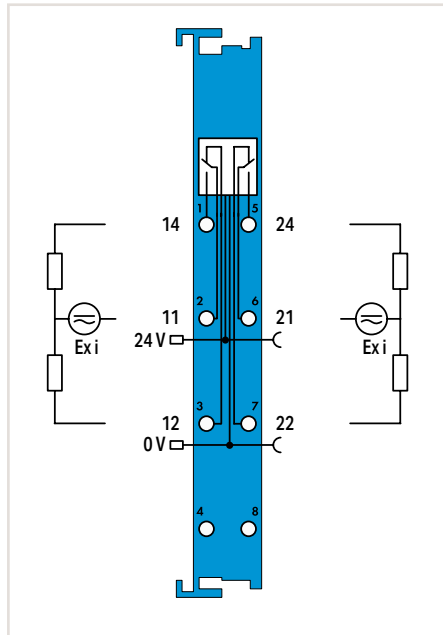


Item Description	2-Channel Digital Output; 24 VDC; Intrinsically safe	4-Channel Digital Output; 24 VDC; Valve; Intrinsically safe
Item No.	750-535	750-539
Order Text	2DO; 24 VDC; Ex i	4DO; 24 VDC; Valve; Ex i
<b>Technical Data</b>		
Number of digital outputs	2	4
Signal type	24 VDC	24 VDC
Output characteristic	High-side switching	High-side switching
Load type	Resistive; inductive; lamp load	Resistive; inductive; lamp load
Actuator connection	2-wire	2-wire
Switching frequency (max.)	1 kHz	100 Hz
Supply voltage (field)	24 VDC (Ex i power supply: $U_o = \text{max. } 27.3 \text{ V}$ ); via power jumper contacts (power supply via blade contact; transmission via spring contact)	24 VDC (Ex i power supply: $U_o = \text{max. } 27.3 \text{ V}$ ); via power jumper contacts (power supply via blade contact; transmission via spring contact)
Current consumption, field supply (module with no external load)	8.5 mA	10 mA
Current consumption – system supply (5 V)	7 mA	20 mA
Data width (internal)	2 bits	4-bit output; 4-bit input (diagnostics)
Isolation	$U_m = 375 \text{ V system/supply}$	$U_m = 375 \text{ V system/supply}$
Surrounding air temperature (operation)	0 ... +55 °C	0 ... +55 °C
Dimensions W x H x D	12 x 67.8 x 100 mm	24 x 67.8 x 100 mm
<b>Explosion Protection</b>		
Safety-relevant data (circuit)	$U_o = 27.3 \text{ V}; I_o = 106 \text{ mA}; P_o = 723 \text{ mW};$ Linear characteristic curve	$U_o = 27.3 \text{ V}; I_o = 117.5 \text{ mA}; P_o = 800.1 \text{ mW};$ Linear characteristic curve
Reactances Ex ia IIC	$L_o = 3 \text{ mH}; C_o = 88 \text{ nF}$	$L_o = 13 \text{ } \mu\text{H}; C_o = 88 \text{ nF}$
Reactances Ex ia IIB	$L_o = 12 \text{ mH}; C_o = 680 \text{ nF}$	$L_o = 8.1 \text{ mH}; C_o = 683 \text{ nF}$
Reactances Ex ia IIA	$L_o = 18 \text{ mH}; C_o = 2.2 \text{ } \mu\text{F}$	$L_o = 14 \text{ mH}; C_o = 2.28 \text{ } \mu\text{F}$
Reactances Ex ia I	$L_o = 20 \text{ mH}; C_o = 3.6 \text{ } \mu\text{F}$	$L_o = 21 \text{ mH}; C_o = 3.6 \text{ } \mu\text{F}$
Reactances	Reactances without accounting for the concurrence of capacitance ( $C_o$ ) and inductance ( $L_o$ )	Reactances without accounting for the concurrence of capacitance ( $C_o$ ) and inductance ( $L_o$ )
Ex guideline	EN IEC 60079-0, -7, -11	EN IEC 60079-0, -7, -11
Approvals	CE; Marine; OrdLoc/HazLoc/AEx; ATEX/IECEX; INMETRO	CE; Marine; ATEX/IECEX
Marking	Ⓜ ATEX/IECEX: II 3 (1) G Ex ec [ia Ga] IIC T4 Gc II (1) D [Ex ia Da] IIIC I (M1) [Ex ia Ma] I	Ⓜ ATEX/IECEX: II 3 (1) G Ex ec [ia Ga] IIC T4 Gc II (1) D [Ex ia Da] IIIC I (M1) [Ex ia Ma] I
Data sheet and further information, see:	<a href="http://wago.com/750-535">wago.com/750-535</a>	<a href="http://wago.com/750-539">wago.com/750-539</a>

5.9

„ Mini-WSB marker card and mounting accessories, see Section "Accessories and Tools"  
 „ Approvals and corresponding ratings, see page 519 or [www.wago.com](http://www.wago.com)

## Relay Output; Ex i



Item Description	<b>2-Channel Relay Output; Changeover contact; Potential-free; Intrinsically safe</b>
Item No.	750-538
Order Text	2RO; Changeover contacts; Pot-free; Ex i
<b>Technical Data</b>	
Number of digital outputs	2
Signal type	100 VAC; 30 VDC*
Output circuit design	Relay with 2 changeover contacts
Output characteristic	Potential-free
Output current per channel	0.5 AAC; 1 ADC*
Actuator connection	2-wire
Switching frequency (max.)	0.33 Hz
Supply voltage (field)	24 VDC (Ex i power supply: $U_0 = \text{max. } 27.3 \text{ V}$ ); via power jumper contacts (power supply via blade contact; transmission via spring contact)
Current consumption, field supply (module with no external load)	24 mA
Current consumption – system supply (5 V)	26 mA
Data width (internal)	2 bits
Isolation	$U_m = 375 \text{ V system/supply}$
Surrounding air temperature (operation)	0 ... +55 °C
Dimensions W x H x D	12 x 67.8 x 100 mm
<b>Explosion Protection</b>	
Safety-relevant data (circuit)	Relay output: $U_i = \text{DC } 30 \text{ V}; I_i = 1 \text{ A}; P_i = 30 \text{ W};$ $U_i = \text{AC } 100 \text{ V}; I_i = 0.5 \text{ A}; P_i = 50 \text{ VA};$ $L_i = \text{negligible};$ $C_i = \text{negligible}$
Ex guideline	EN IEC 60079-0, -7, -11
Approvals	CE; Marine; OrdLoc/HazLoc/AEx; ATEX/IECEX; INMETRO
Marking	⊕ ATEX/IECEX: II 3 (1) G Ex ec [ia Ga] IIC T4 Gc II (1) D [Ex ia Da] IIIC I (M1) [Ex ia Ma] I
Data sheet and further information, see:	<a href="http://wago.com/750-538">wago.com/750-538</a>

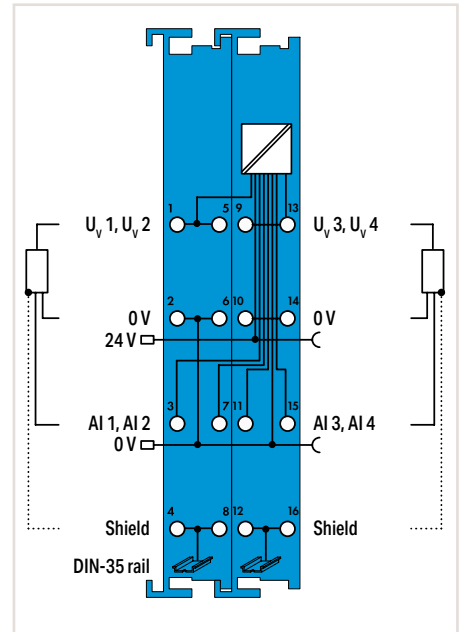
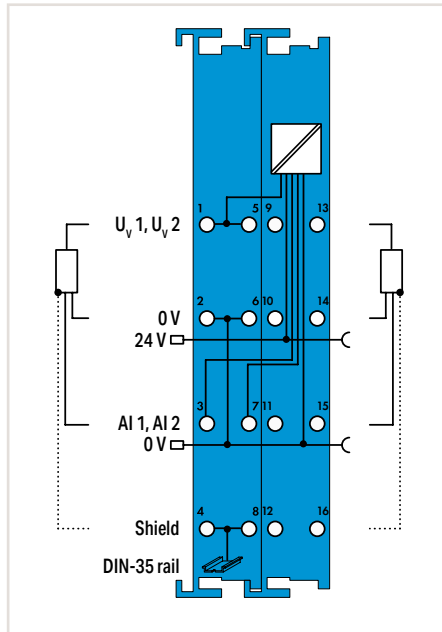
\*Details on relay!

Both maximum switching current and voltage must comply with EN 60079-11.

## Analog Input; 4 ... 20 mA or 0/4 ... 20 mA; Ex i



Figure: 750-486



Item Description	2-Channel Analog Input; 4 ... 20 mA; Intrinsically safe	4-Channel Analog Input; 0/4 ... 20 mA; NAMUR NE43; Intrinsically safe
Item No.	750-485	750-486
Order Text	4AI; 4-20mA; Ex i	4AI; 0/4-20mA; NE43; Ex i
<b>Technical Data</b>		
Number of analog inputs	2	4
Signal type	4 ... 20 mA	0 ... 20 mA; 4 ... 20 mA; 3.6 ... 21 mA
Signal characteristic	Single-ended	Single-ended
Input resistance	< 100 Ω	< 200 Ω
Resolution	12 bits	12 bits + sign bit
Conversion time	< 2 ms	< 10 ms
Measuring error (max.) at 25 °C	±0.2 % of the upper-range value	±0.1 % of the upper-range value
Temperature error (max.)	±0.01 %/K of the upper-range value	±0.01 %/K of the upper-range value
Supply voltage (field)	24 VDC (Ex i power supply: U <sub>O</sub> = max. 27.3 V); via power jumper contacts (power supply via blade contact; transmission via spring contact)	24 VDC (Ex i power supply: U <sub>O</sub> = max. 27.3 V); via power jumper contacts (power supply via blade contact; transmission via spring contact)
Current consumption, field supply (module with no external load)	11 mA	19 mA
Current consumption – system supply (5 V)	31 mA	45 mA
Transmitter supply	U <sub>V</sub> = 16 V at 20 mA	U <sub>V</sub> = 15 V at 20 mA
Data width	2 x 16-bit data; 2 x 8-bit control/status (optional)	4 x 16-bit data; 4 x 8-bit control/status (optional)
Isolation	U <sub>m</sub> = 375 V system/supply	U <sub>m</sub> = 375 V system/supply
Surrounding air temperature (operation)	0 ... +55 °C	0 ... +55 °C
Dimensions W x H x D	24 x 67.8 x 100 mm	24 x 67.8 x 100 mm
<b>Explosion Protection</b>		
Safety-relevant data (circuit)	U <sub>O</sub> = 27.3 V; I <sub>O</sub> = 90 mA; P <sub>O</sub> = 0.61 mW; Linear characteristic curve	U <sub>O</sub> = 27.3 V; I <sub>O</sub> = 98.4 mA; P <sub>O</sub> = 0.672 mW; Linear characteristic curve
Reactances Ex ia IIC	L <sub>O</sub> = 5 mH; C <sub>O</sub> = 88 nF	L <sub>O</sub> = 970 μH; C <sub>O</sub> = 88 nF
Reactances Ex ia IIB	L <sub>O</sub> = 18 mH; C <sub>O</sub> = 680 nF	L <sub>O</sub> = 13 mH; C <sub>O</sub> = 683 nF
Reactances Ex ia IIA	L <sub>O</sub> = 40 mH; C <sub>O</sub> = 2.2 μF	L <sub>O</sub> = 22 mH; C <sub>O</sub> = 2.28 μF
Reactances Ex ia I	L <sub>O</sub> = 100 mH; C <sub>O</sub> = 3.5 μF	L <sub>O</sub> = 31 mH; C <sub>O</sub> = 3.6 μF
Reactances	Reactances without accounting for the concurrence of capacitance (C <sub>O</sub> ) and inductance (L <sub>O</sub> )	Reactances without accounting for the concurrence of capacitance (C <sub>O</sub> ) and inductance (L <sub>O</sub> )
Ex guideline	EN IEC 60079-0, -7, -11	EN IEC 60079-0, -7, -11
Approvals	CE; Marine; OrdLoc/HazLoc/AEx; ATEX/IECEX; INMETRO	CE; Marine; ATEX/IECEX
Marking	Ⓢ ATEX/IECEX: II 3 (1) G Ex ec [ia Ga] IIC T4 Gc II (1) D [Ex ia Da] IIIC I (M1) [Ex ia Ma] I	Ⓢ ATEX/IECEX: II 3 (1) G Ex ec [ia Ga] IIC T4 Gc II (1) D [Ex ia Da] IIIC I (M1) [Ex ia Ma] I
Data sheet and further information, see:	wago.com/750-485	wago.com/750-486

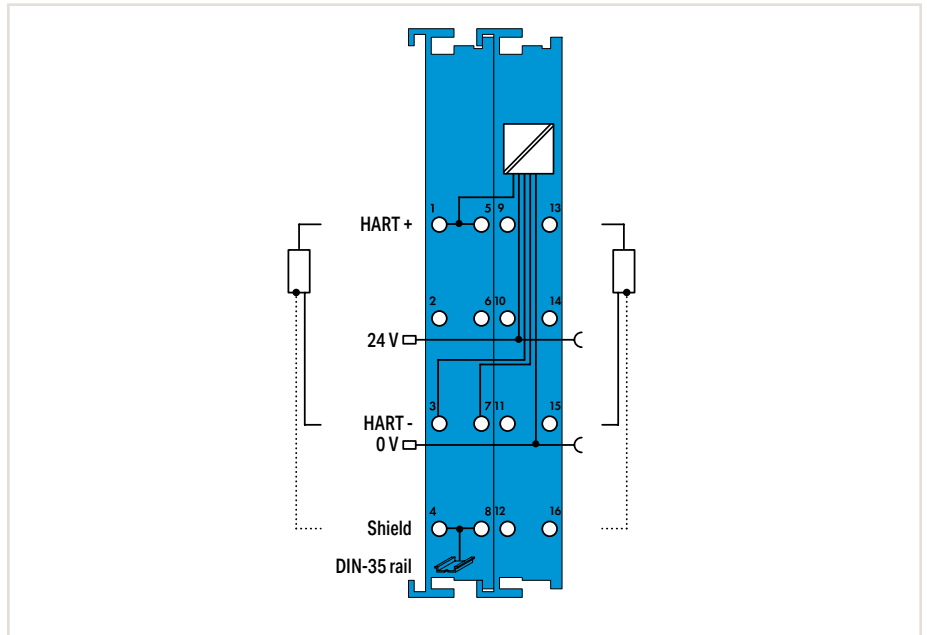
„ Mini-WSB marker card and mounting accessories, see Section "Accessories and Tools"

„ Approvals and corresponding ratings, see page 520 or www.wago.com

## Analog Input; 4 ... 20 mA HART; Ex i



Figure: 750-484



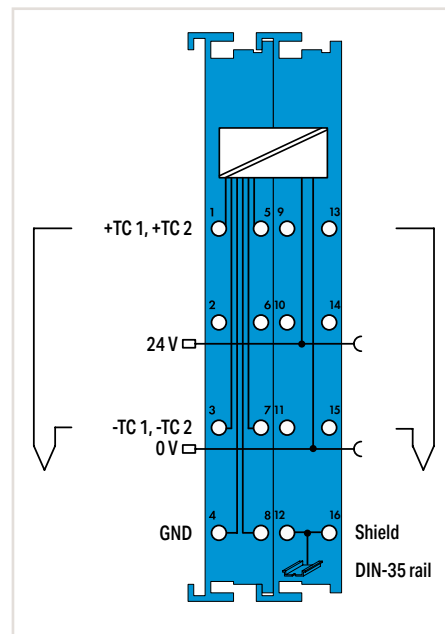
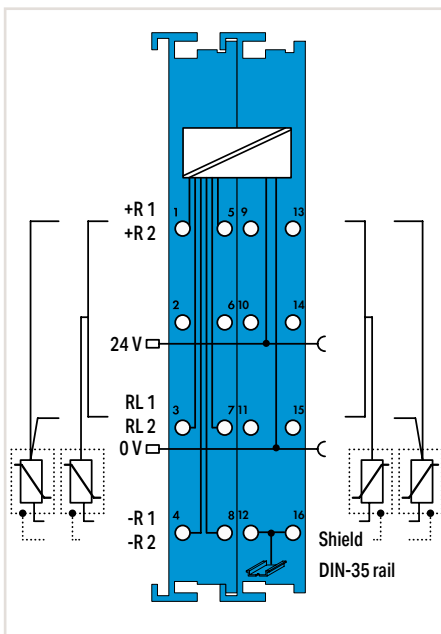
Item Description	2-Channel Analog Input; 4 ... 20 mA HART; Intrinsically safe	2-Channel Analog Input; 4 ... 20 mA HART; NAMUR NE43; Intrinsically safe
Item No.	750-484	750-484/000-001
Order Text	2AI; 4–20mA HART; Ex i	2AI 4–20 mA HART NAMUR NE43 Ex i
<b>Technical Data</b>		
Number of analog inputs	2	
Signal type	4 ... 20 mA	
Signal characteristic	Single-ended	
Resolution	12 bits	
Conversion time	10 ms	
Measuring error (max.) at 25 °C	0.2 % of the upper-range value	
Temperature error (max.)	±0.01 %/K of the upper-range value	
Supply voltage (field)	24 VDC (Ex i power supply: $U_0 = \text{max. } 27.3 \text{ V}$ ); via power jumper contacts (power supply via blade contact; transmission via spring contact)	
Current consumption, field supply (module with no external load)	26 mA	
Current consumption – system supply (5 V)	25 mA	
Transmitter supply	$U_V = 16.5 \text{ V}$ at 20 mA	
Data width	2 x 2-byte data; 2 x 2-byte data + 2n x 4-byte data (n = number of dynamic variables); 2 x 2-byte data + 6-byte mailbox	
Isolation	$U_m = 375 \text{ V}$ system/supply	
Surrounding air temperature (operation)	0 ... +55 °C	
Dimensions W x H x D	24 x 67.8 x 100 mm	
<b>Explosion Protection</b>		
Safety-relevant data (circuit)	$U_0 = 27.3 \text{ V}$ ; $I_0 = 92.7 \text{ mA}$ ; $P_0 = 630 \text{ mW}$ ; Linear characteristic curve	
Reactances Ex ia IIC	$L_0 = 1.5 \text{ mH}$ ; $C_0 = 87 \text{ nF}$	
Reactances Ex ia IIB	$L_0 = 15 \text{ mH}$ ; $C_0 = 670 \text{ nF}$	
Reactances Ex ia IIA	$L_0 = 38 \text{ mH}$ ; $C_0 = 2.2 \mu\text{F}$	
Reactances Ex ia I	$L_0 = 36 \text{ mH}$ ; $C_0 = 3.49 \mu\text{F}$	
Reactances	Reactances without accounting for the concurrence of capacitance ( $C_0$ ) and inductance ( $L_0$ )	
Ex guideline	EN IEC 60079-0, -7, -11	
Approvals	CE; Marine; OrdLoc/HazLoc/AEx; ATEX/IECEX; INMETRO	CE; OrdLoc/HazLoc; ATEX/IECEX
Marking	ATEX/IECEX: II 3 (1) G II (1) D I (M1)	Ex ec [ja Ga] IIC T4 Gc [Ex ia Da] IIIC [Ex ia Ma] I
Data sheet and further information, see:	<a href="http://wago.com/750-484">wago.com/750-484</a>	<a href="http://wago.com/750-484/000-001">wago.com/750-484/000-001</a>

In addition to analog signal processing, this module offers optional HART communication for parameterizing or recording dynamic variables.

## Analog Input; for Resistance Sensors or Thermocouples; Ex i



Figure: 750-481/003-000



**Item Description**

**Item No.**

**Order Text**

**Technical Data**

Number of analog inputs

Signal type

Sensor connection

Temperature range

Resolution

Conversion time

Measuring error (max.) at 25 °C

Temperature error (max.)

Cold junction compensation

Supply voltage (field)

Current consumption, field supply (module with no external load)

Current consumption – system supply (5 V)

Data width

Isolation

Surrounding air temperature (operation)

Dimensions W x H x D

**Explosion Protection**

Safety-relevant data (circuit)

Reactances Ex ia IIC

Reactances Ex ia IIB

Reactances Ex ia IIA

Reactances Ex ia I

Reactances

Ex guideline

Approvals

Marking

Data sheet and further information, see:

**2-Channel Analog Input; Resistance measurement; Intrinsically safe**

750-481/003-000

2AI; RTD; Ex i

2

Resistance thermometers: Pt100; Pt200; Pt500; Pt1000; Ni100; Ni120; Ni1000; Resistors: 1.2 kΩ; 5 kΩ; Potentiometer setting: 0 ... 100 %

2-wire; 3-wire

-200 ... + 850 °C (Pt); -60 ... +250 °C (Ni); -80 ... +320 °C (Ni 120)

0.1 °C; 0.1 Ω; 0.0049 %

150 ... 500 ms (per channel)

±0.2 % of the upper-range value

±0.01 %/K of the upper-range value

24 VDC (Ex i power supply:  $U_o = \text{max. } 27.3 \text{ V}$ ); via power jumper contacts (power supply via blade contact; transmission via spring contact)

12 mA

25 mA

2 x 16-bit data; 2 x 8-bit control/status (optional)

$U_m = 375 \text{ V}$  system/supply

0 ... +55 °C

24 x 67.8 x 100 mm

$U_o = 7.2 \text{ V}$ ;  $I_o = 5.8 \text{ mA}$ ;  $P_o = 10.5 \text{ mW}$ ; Linear characteristic curve

$L_o = 0.9 \text{ H}$ ;  $C_o = 13.5 \mu\text{F}$

$L_o = 1 \text{ H}$ ;  $C_o = 240 \mu\text{F}$

$L_o = 1 \text{ H}$ ;  $C_o = 1000 \mu\text{F}$

$L_o = 1 \text{ H}$ ;  $C_o = 1000 \mu\text{F}$

Reactances without accounting for the concurrence of capacitance ( $C_o$ ) and inductance ( $L_o$ )

EN IEC 60079-0, -7, -11

CE; Marine; OrdLoc/HazLoc/AEx; ATEX/IECEX; INMETRO

ATEX/IECEX: II 3 (1) G Ex ec [ia Ga] IIC T4 Gc II (1) D [Ex ia Da] IIIC I (M1) [Ex ia Ma] I

wago.com/750-481/003-000

**2-Channel Analog Input; Thermocouple; Intrinsically safe**

750-487/003-000

2AI; TC; Ex i

2

Thermocouples: Type B; E; J; K; L; N; R; S; T; U; Voltage encoders: ±30 mV; ±60 mV; ±120 mV

2-wire

-100 ... +1,800 °C

0.1 °C or 0.01 mV for voltage measurement ≤ 320 ms (both channels)

±6 K (type K); Voltage input ±2 K; Cold junction compensation ±4 K

±0.2 K/K of the upper-range value (type K)

Integrated or external

24 VDC (Ex i power supply:  $U_o = \text{max. } 27.3 \text{ V}$ ); via power jumper contacts (power supply via blade contact; transmission via spring contact)

8.5 mA

13.5 mA

2 x 16-bit data; 2 x 8-bit control/status (optional)

$U_m = 375 \text{ V}$  system/supply

0 ... +55 °C

24 x 67.8 x 100 mm

$U_o = 14.4 \text{ V}$ ;  $I_o = 29.1 \text{ mA}$ ;  $P_o = 52.4 \text{ mW}$ ; Linear characteristic curve

$L_o = 52 \text{ mH}$ ;  $C_o = 650 \text{ nF}$

$L_o = 100 \text{ mH}$ ;  $C_o = 4.0 \mu\text{F}$

$L_o = 300 \text{ mH}$ ;  $C_o = 15.8 \mu\text{F}$

$L_o = 400 \text{ mH}$ ;  $C_o = 17.9 \mu\text{F}$

Reactances without accounting for the concurrence of capacitance ( $C_o$ ) and inductance ( $L_o$ )

EN IEC 60079-0, -7, -11

CE; Marine; OrdLoc/HazLoc/AEx; ATEX/IECEX; INMETRO

ATEX/IECEX: II 3 (1) G Ex ec [ia Ga] IIC T4 Gc II (1) D [Ex ia Da] IIIC I (M1) [Ex ia Ma] I

wago.com/750-487/003-000

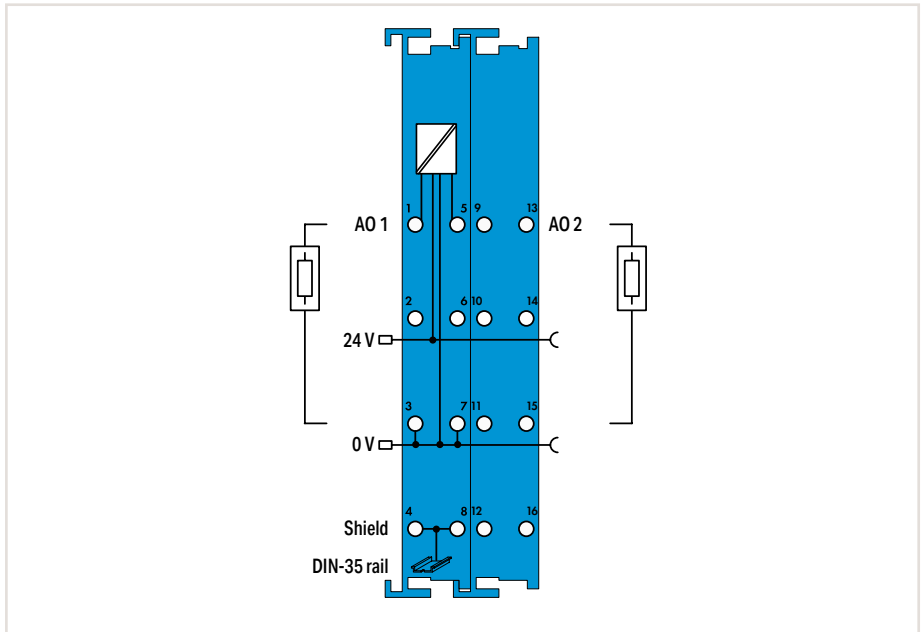
5.9



# Analog Output; 0 ... 20 mA or 4 ... 20 mA; Ex i



Figure: 750-585



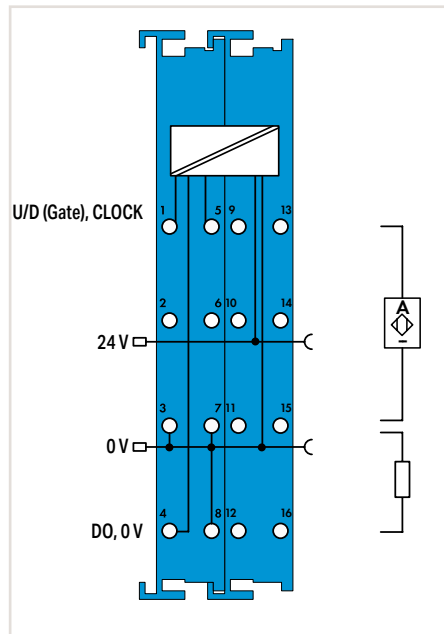
Item Description	2-Channel Analog Output; 0 ... 20 mA; Intrinsically safe	2-Channel Analog Output; 4 ... 20 mA; Intrinsically safe
Item No.	750-585	750-586
Order Text	2AO; 0–20mA; Ex i	2AO; 4–20mA; Ex i
<b>Technical Data</b>		
Number of analog outputs	2	
Signal type	0 ... 20 mA	4 ... 20 mA
Signal characteristic	Single-ended	
Load impedance	< 500 Ω	
Resolution	12 bits	
Conversion time	< 2 ms	
Output error (max.) at 25 °C	±0.2 % of the upper-range value	
Temperature error (max.)	±0.01 %/K of the upper-range value	
Supply voltage (field)	24 VDC (Ex i power supply: U <sub>o</sub> = max. 27.3 V); via power jumper contacts (power supply via blade contact; transmission via spring contact)	
Current consumption, field supply (module with no external load)	19 mA	
Current consumption – system supply (5 V)	21 mA	
Data width	2 x 16-bit data	
Isolation	U <sub>m</sub> = 375 V system/supply	
Surrounding air temperature (operation)	0 ... +55 °C	
Dimensions W x H x D	24 x 67.8 x 100 mm	
<b>Explosion Protection</b>		
Safety-relevant data (circuit)	U <sub>o</sub> = 27.3 V; I <sub>o</sub> = 57.5 mA; P <sub>o</sub> = 392 mW; Linear characteristic curve	
Reactances Ex ia IIC	L <sub>o</sub> = 11 mH; C <sub>o</sub> = 88 nF	
Reactances Ex ia IIB	L <sub>o</sub> = 56 mH; C <sub>o</sub> = 680 nF	
Reactances Ex ia IIA	L <sub>o</sub> = 90 mH; C <sub>o</sub> = 2.2 μF	
Reactances Ex ia I	L <sub>o</sub> = 110 mH; C <sub>o</sub> = 3.5 μF	
Reactances	Reactances without accounting for the concurrence of capacitance (C <sub>o</sub> ) and inductance (L <sub>o</sub> )	
Ex guideline	EN IEC 60079-0, -7, -11	
Approvals	CE; Marine; OrdLoc/HazLoc/AEx; ATEX/IECEX; INMETRO	
Marking	ATEX/IECEX: II 3 (1) G Ex ec [ia Ga] IIC T4 Gc II (1) D [Ex ia Da] IIIC I (M1) [Ex ia Ma] I	
Data sheet and further information, see:	wago.com/750-585	wago.com/750-586

5.9

„ Mini-WSB marker card and mounting accessories, see Section “Accessories and Tools”

„ Approvals and corresponding ratings, see page 520, 521 or www.wago.com

## Up/Down Counter; Ex i



Item Description	Up/Down Counter; Intrinsically safe
Item No.	750-633
Order Text	Up/Down Counter; Ex i
<b>Technical Data</b>	
Number of counters	1
Number of outputs	1
Sensor supply UV	8.2 VDC
Input filter	10 $\mu$ s
Switching frequency	20 Hz ... 50 kHz
Counter depth	32 bits
Output voltage	24 VDC
Supply voltage (field)	24 VDC (Ex i power supply: $U_o = \text{max. } 27.3 \text{ V}$ ); via power jumper contacts (power supply via blade contact; transmission via spring contact)
Current consumption, field supply (module with no external load)	31 mA
Current consumption – system supply (5 V)	25 mA
Data width	1 x 32-bit data, 1 x 8-bit status/diagnostics
Isolation	$U_m = 375 \text{ V system/supply}$
Surrounding air temperature (operation)	0 ... +55 $^{\circ}\text{C}$
Dimensions W x H x D	24 x 67.8 x 100 mm
<b>Explosion Protection</b>	
Safety data – input	$U_o = 12 \text{ V}; I_o = 13.5 \text{ mA}; P_o = 40.5 \text{ mW};$ Linear characteristic curve
Input reactances Ex ia IIC	$L_o = 100 \text{ mH}; C_o = 1.4 \mu\text{F}$
Input reactances Ex ia IIB	$L_o = 100 \text{ mH}; C_o = 9 \mu\text{F}$
Input reactances Ex ia IIA	$L_o = 100 \text{ mH}; C_o = 36 \mu\text{F}$
Input reactances Ex ia I	$L_o = 100 \text{ mH}; C_o = 38 \mu\text{F}$
Safety data – output	$U_o = 27.3 \text{ V}; I_o = 103 \text{ mA}; P_o = 703 \text{ mW};$ Linear characteristic curve
Output reactances Ex ia IIC	$L_o = 0.5 \text{ mH}; C_o = 88 \text{ nF}$
Output reactances Ex ia IIB	$L_o = 10 \text{ mH}; C_o = 683 \text{ nF}$
Output reactances Ex ia IIA	$L_o = 18 \text{ mH}; C_o = 2.2 \mu\text{F}$
Output reactances Ex ia I	$L_o = 26 \text{ mH}; C_o = 3.6 \mu\text{F}$
Ex guideline	EN IEC 60079-0, -7, -11
Approvals	CE;  Marine;  OrdLoc/HazLoc/AEx; ATEX/IECEX; INMETRO
Marking	ATEX/IECEX: II 3 (1) G Ex ec [ia Ga] IIC T4 Gc II (1) D [Ex ia Da] IIIC I (M1) [Ex ia Ma] I
Data sheet and further information, see:	<a href="http://wago.com/750-633">wago.com/750-633</a>

Reactances without accounting for the concurrence of capacitance ( $C_o$ ) and inductance ( $L_o$ )

„ Mini-WSB marker card and mounting accessories,  
see Section “Accessories and Tools”

„ Approvals and corresponding ratings,  
see page 522 or [www.wago.com](http://www.wago.com)

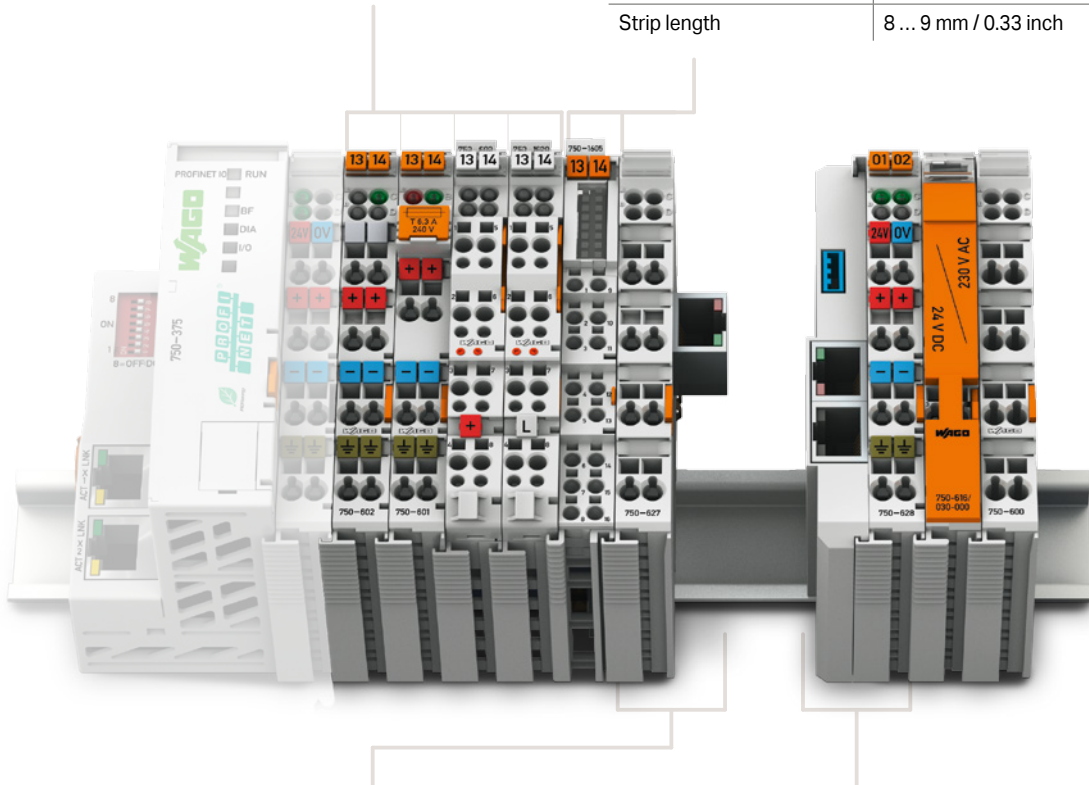
# Supply/Segment Modules

## Housing design (750/753 Series)

Dimensions W x H x D	12 x 69.8 x 100 mm
Height from upper-edge of DIN-rail	62.6 mm
Connection technology	CAGE CLAMP®
Conductor cross section	0.08 ... 2.5 mm <sup>2</sup> / 28 ... 14 AWG
Strip length	750 Series: 8 ... 9 mm / 0.33 inch 753 Series: 9 ... 10 mm / 0.37 inch

## Housing design (750 Series), with Push-in CAGE CLAMP® connections (up to 16 connection points)

Dimensions W x H x D	12 x 69 x 100 mm
Height from upper-edge of DIN-rail	61.8 mm
Connection technology	Push-in CAGE CLAMP®
Conductor cross section	Solid: 0.08 ... 2.5 mm <sup>2</sup> / 28 ... 16 AWG Fine-stranded: 0.25 ... 1.5 mm <sup>2</sup> / 22 ... 16 AWG
Strip length	8 ... 9 mm / 0.33 inch



## Specialty housing (end module for bus extension)

Dimensions W x H x D	24 x 69.8 x 100
Height from upper-edge of DIN-rail	62.6 mm

## Specialty housing (coupler module for bus extension)

Dimensions W x H x D	24 x 69.8 x 100
Height from upper-edge of DIN-rail	62.6 mm



I/O System -  
750 XTR Series



## I/O System – 750 and 753 Series, Supply/Segment Modules

### Contents

Function	Description	Item Number			Page	
		Standard	Extended Temperature	Pluggable		
Power Supply 24 VDC	Power Supply; 24 VDC	750-602*	750-602/025-000	753-602	324	
	Power Supply; 24 VDC/5 ... 15 VDC	750-623			324	
	Power Supply; 24 VDC; Fuse holder	750-601*			325	
	Power Supply; 24 VDC; Fuse holder; Diagnostics	750-610*			325	
	24 VDC with Bus Power Supply	System Power Supply; 24 VDC	750-613*			326
		Power Supply; 0 ... 230 VAC/DC	750-612*		753-612	327
	230 VAC/DC	Power Supply; 24 VAC; Fuse holder	750-617			328
	24 VAC	Power Supply; 120 VAC; Fuse holder	750-615			328
	120 VAC	Power Supply; 230 VAC; Fuse holder	750-609			329
230 VAC	Power Supply; 230 VAC; Fuse holder; Diagnostics	750-611			329	
DALI Multi-Master DC/DC Converter	DALI Multi-Master DC/DC Converter			753-620	330	
Potential Distribution	Potential Distribution	750-614*		753-614	331	
	Potential Distribution; 8x 24 V	750-603		753-603	332	
	Potential Distribution; 8x 0 V	750-604		753-604	332	
	Potential Distribution; 16x 24 V	750-1605*			333	
	Potential Distribution; 16x 0 V	750-1606*			333	
	Potential Distribution; 8x 24 V/8x 0 V	750-1607			333	
Filter Modules	Field Supply Filter (Surge); 24 VDC; Higher isolation	750-624/020-000*			334	
	Field Supply Filter (Surge); 24 VDC; Higher isolation; Without power jumper contacts	750-624/020-001*			334	
	Field Supply Filter (Surge); 24 VDC; Higher isolation; Ground fault diagnostics	750-624/020-002			334	
	Field Supply Filter (Surge); 24 VDC	750-624			335	
	Field Supply Filter (Surge); 24 VDC; Without power jumper contacts	750-624/000-001			335	
	Supply Filter; 24 VDC; Higher isolation	750-626/020-000*	750-626/025-001		336	
	Supply Filter; 24 VDC; Higher isolation; Ground fault diagnostics	750-626/020-002			336	
	Supply Filter; 24 VDC	750-626	750-626/025-000		337	
Local Bus Extension	Bus Extension End Module	750-627			338	
	Bus Extension Coupler Module	750-628			338	
Spacer Modules	Binary Spacer Module	750-622			339	
	Spacer Module; Active			753-1629	340	
	Spacer Module; Active; Without power jumper contacts			753-1629/000-001	340	
	Spacer Module; Passive			753-629/020-000	340	
Distance Modules	Distance Module	750-616*			341	
	Distance Module; 24 VDC/230 VAC	750-616/030-000			341	
	Distance Module	750-621			341	
End Module	End Module	750-600*	750-600/025-000		342	
Ex i		See Section 5.9				
*This module is also available as a variant of the 750 XTR Series.		See Section 6				

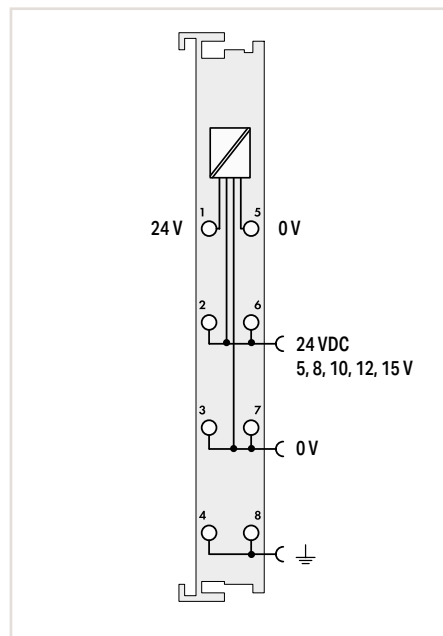
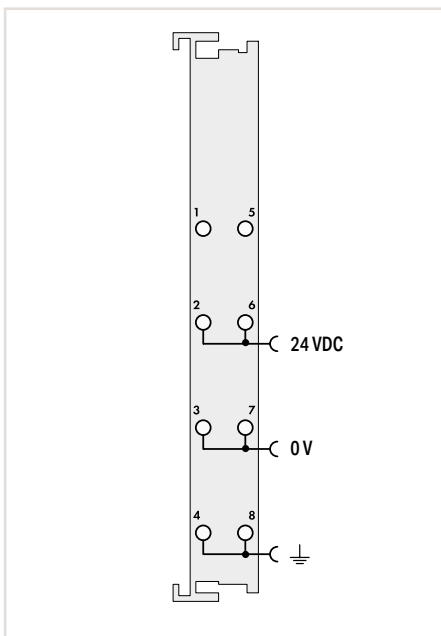
## Power Supply; 24 VDC



Figure: 750-602



Figure: 750-623



Item Description
Version
Item No.
Order Text

Power Supply; 24 VDC		
Standard	Extended temperature	Pluggable (delivery without connector)
750-602	750-602/025-000	753-602
Power Supply; 24 VDC	Power Supply; 24 VDC; T	Power Supply; 24 VDC

Power Supply; 24 VDC/5 ... 15 VDC	
Standard	
750-623	
Power Supply; 24/5–15 VDC	

5.10

Technical Data	
Pluggable connector	
Supply voltage (system)	
Supply voltage (field)	
Total current (system supply)	
Current carrying capacity (power jumper contacts)	
Surrounding air temperature (operation)	
Dimensions W x H x D	
Approvals	
Data sheet and further information, see:	

		•
5 VDC; via data contacts		
24 VDC (–25 ... +30 %); via power jumper contacts (power supply via CAGE CLAMP® connection; transmission via spring contact)		
10 A		
0 ... +55 °C	–20 ... +60 °C	0 ... +55 °C
12 x 69.8 x 100 mm		
CE;  Marine;  OrdLoc/HazLoc;  ATEX/IECEX		
<a href="http://wago.com/750-602">wago.com/750-602</a>		<a href="http://wago.com/753-602">wago.com/753-602</a>

5 VDC; via data contacts	
24 VDC (–15 ... +20 %); via power jumper contacts (power supply via CAGE CLAMP® connection; transmission via spring contact); Output voltage adjustable in steps via DIP switch: 5 V; 8 V; 10 V; 12 V; 15 V	
0.5 A (1 A at 5 V)	
0 ... +55 °C	
12 x 69.8 x 100 mm	
CE;  Marine;  OrdLoc/HazLoc;  ATEX/IECEX	
<a href="http://wago.com/750-623">wago.com/750-623</a>	

Accessories	
Pluggable connector	Item No.
Coding keys	

	753-110
	753-150

This I/O module provides the applied supply voltage to the field devices connected to downstream I/O modules.

This I/O module converts the applied supply voltage to a value selected via DIP switch and provides it to the field devices connected to the downstream I/O modules.

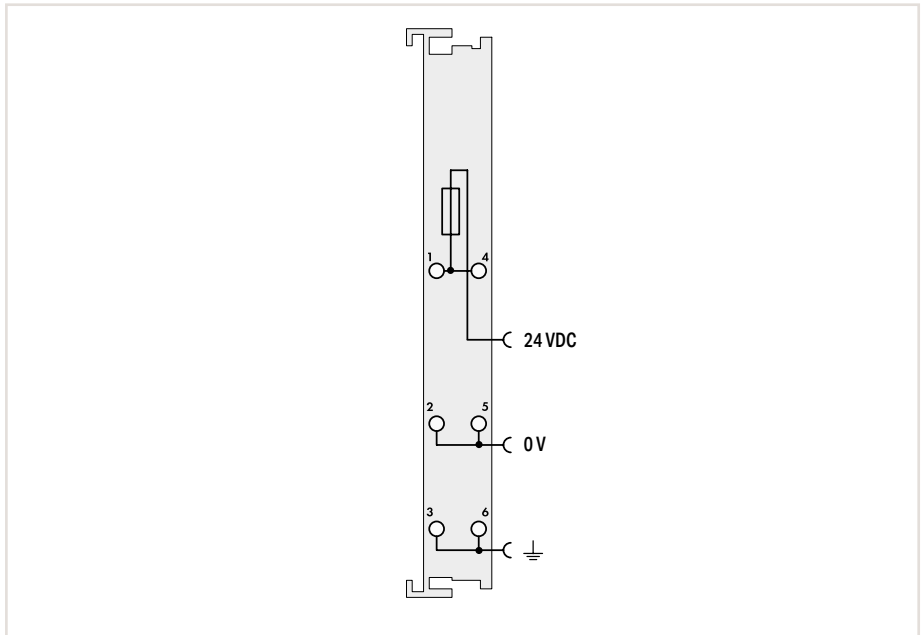
„ Mini-WSB marker card and mounting accessories, see Section “Accessories and Tools”

„ Approvals and corresponding ratings, see page 523 or [www.wago.com](http://www.wago.com)

# Power Supply; 24 VDC



Figure: 750-601

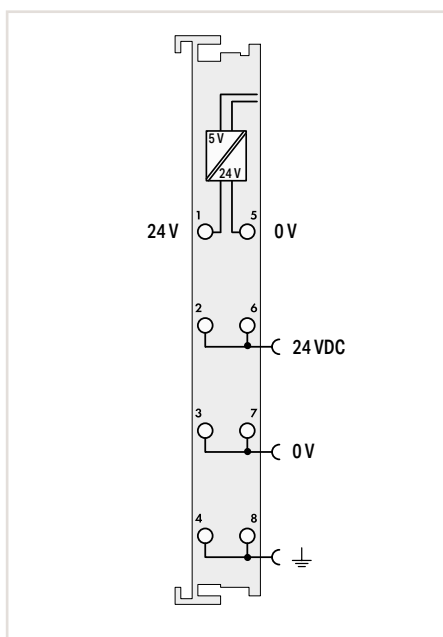


<b>Item Description</b>	<b>Power Supply; 24 VDC; Fuse holder</b>	
<b>Version</b>	<b>Standard</b>	<b>Diagnostics</b>
<b>Item No.</b>	750-601	750-610
<b>Order Text</b>	Power Supply; 24 VDC; Fuse	Power Supply; 24 VDC; Fuse; Diagn
<b>Technical Data</b>		
Supply voltage (field)	24 VDC (-25 ... +30 %); via power jumper contacts (power supply via CAGE CLAMP® connection; transmission via spring contact)	
Current carrying capacity (power jumper contacts)	6.3 A	
Fuse	5 x 20; T max. 6.3 A (not included)	
Diagnostics		Supply voltage, field: Detection "on" at > 15 VDC; Detection "off" at < 5 VDC
Current consumption – system supply (5 V)		5 mA
Data width (internal)		2 bits (1-bit current monitoring; 1-bit fuse fault)
Surrounding air temperature (operation)	0 ... +55 °C	
Dimensions W x H x D	12 x 69.8 x 100 mm	
<b>Approvals</b>	CE; Marine; OrdLoc/HazLoc; ATEX/IECEx	
<b>Data sheet and further information, see:</b>	<a href="http://wago.com/750-601">wago.com/750-601</a>	<a href="http://wago.com/750-610">wago.com/750-610</a>

This I/O module provides the applied supply voltage, protected by fuse, to the field devices connected to downstream I/O modules. A blown fuse is indicated by an LED.

This I/O module provides the applied supply voltage, protected by fuse, to the field devices connected to downstream I/O modules. A blown fuse is indicated by an LED. The fuse status can also be queried from the fieldbus coupler.

## System Power Supply; 24 VDC



<b>Item Description</b>	<b>System Power Supply; 24 VDC</b>
<b>Version</b>	<b>Standard</b>
<b>Item No.</b>	<b>750-613</b>
<b>Order Text</b>	System Power Supply; 24 VDC
<b>Technical Data</b>	
Supply voltage, system (24 V)	24 VDC (-25 ... +30 %); power supply and transmission via CAGE CLAMP® connection
Input current (typ.) at nominal load (24 V)	500 mA
Power supply efficiency (typ.) at nominal load (24 V)	90 %
Total current (system supply)	2000 mA
Supply voltage (field)	24 VDC (-25 ... +30 %); via power jumper contacts (power supply via CAGE CLAMP® connection; transmission via spring contact)
Current carrying capacity (power jumper contacts)	10 A
Isolation	500 V system/field
Surrounding air temperature (operation)	0 ... +55 °C
Dimensions W x H x D	12 x 69.8 x 100 mm
<b>Approvals</b>	CE; Marine; OrdLoc/HazLoc; ATEX/IECEX
<b>Data sheet and further information, see:</b>	<a href="http://wago.com/750-613">wago.com/750-613</a>

This I/O module provides the applied supply voltage to the field devices connected to downstream I/O modules. It also serves as an additional system supply for large nodes, covering the power demands of the I/O modules themselves.

„ Mini-WSB marker card and mounting accessories, see Section “Accessories and Tools”

„ Approvals and corresponding ratings, see page 523 or [www.wago.com](http://www.wago.com)



## Power Supply; 0 ... 230 VAC/DC



Figure: 750-612

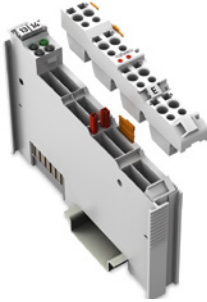
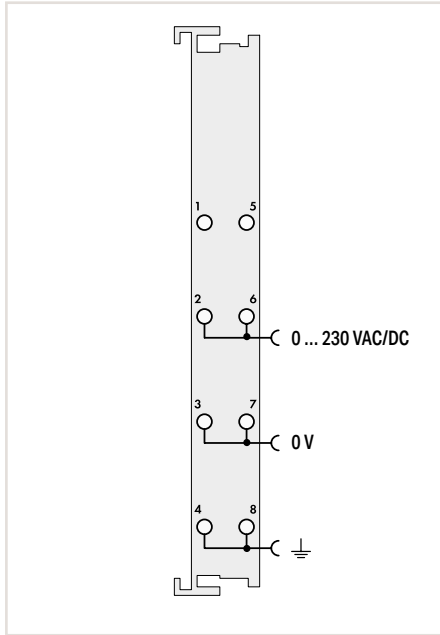


Figure: 753-612



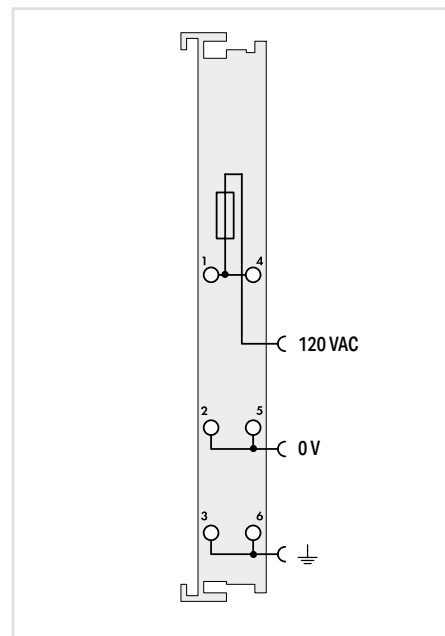
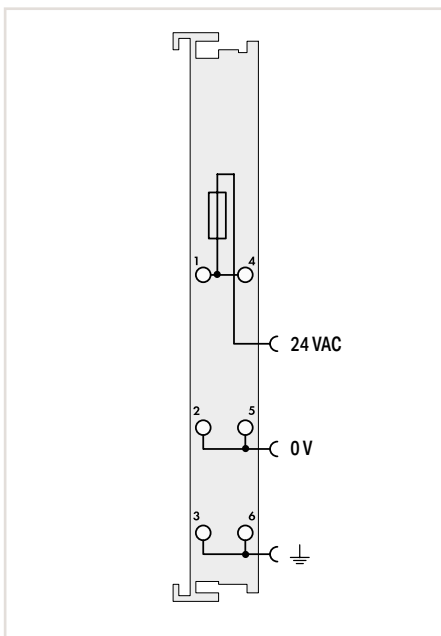
Item Description		Power Supply; 0 ... 230 VAC/DC	
Version		Standard	Pluggable (delivery without connector)
Item No.		750-612	753-612
Order Text		Power Supply; 0-230 VAC/VDC	Power Supply; 0-230 VAC/VDC
<b>Technical Data</b>			
Pluggable connector			●
Supply voltage (field)		0 ... 230 VAC/DC (-15 ... +10 %); via power jumper contacts (power supply via CAGE CLAMP® connection; transmission via spring contact)	
Current carrying capacity (power jumper contacts)		10 A	
Surrounding air temperature (operation)		0 ... +55 °C	
Dimensions W x H x D		12 x 69.8 x 100 mm	
Approvals		CE; ;  Marine;  OrdLoc/HazLoc;  ATEX/IECEX	
Data sheet and further information, see:		<a href="http://wago.com/750-612">wago.com/750-612</a>	<a href="http://wago.com/753-612">wago.com/753-612</a>
<b>Accessories</b>		<b>Item No.</b>	
Pluggable connector		753-110	
Coding keys		753-150	

This I/O module provides the applied supply voltage to the field devices connected to downstream I/O modules.

## Power Supply; 24 VAC or 120 VAC



Figure: 750-617



Item Description	Power Supply; 24 VAC; Fuse holder	Power Supply; 120 VAC; Fuse holder
Version	Standard	Standard
Item No.	750-617	750-615
Order Text	Power Supply; 24 VAC; Fuse	Power Supply; 120 VAC; Fuse
<b>Technical Data</b>		
Supply voltage (field)	24 VAC; via power jumper contacts (power supply via CAGE CLAMP® connection; transmission via spring contact)	120 VAC; via power jumper contacts (power supply via CAGE CLAMP® connection; transmission via spring contact)
Current carrying capacity (power jumper contacts)	6.3 A	6.3 A
Fuse	5 x 20; T max. 6.3 A (not included)	5 x 20; T max. 6.3 A (not included)
Surrounding air temperature (operation)	0 ... +55 °C	0 ... +55 °C
Dimensions W x H x D	12 x 69.8 x 100 mm	12 x 69.8 x 100 mm
Approvals	CE, I, U, OrdLoc	CE, I, U, OrdLoc/HazLoc, ATEX/IECEx
Data sheet and further information, see:	<a href="http://wago.com/750-617">wago.com/750-617</a>	<a href="http://wago.com/750-615">wago.com/750-615</a>

This I/O module provides the applied supply voltage, protected by fuse, to the field devices connected to downstream I/O modules. A blown fuse is indicated by an LED.

This I/O module provides the applied supply voltage, protected by fuse, to the field devices connected to downstream I/O modules. A blown fuse is indicated by an LED.

5.10

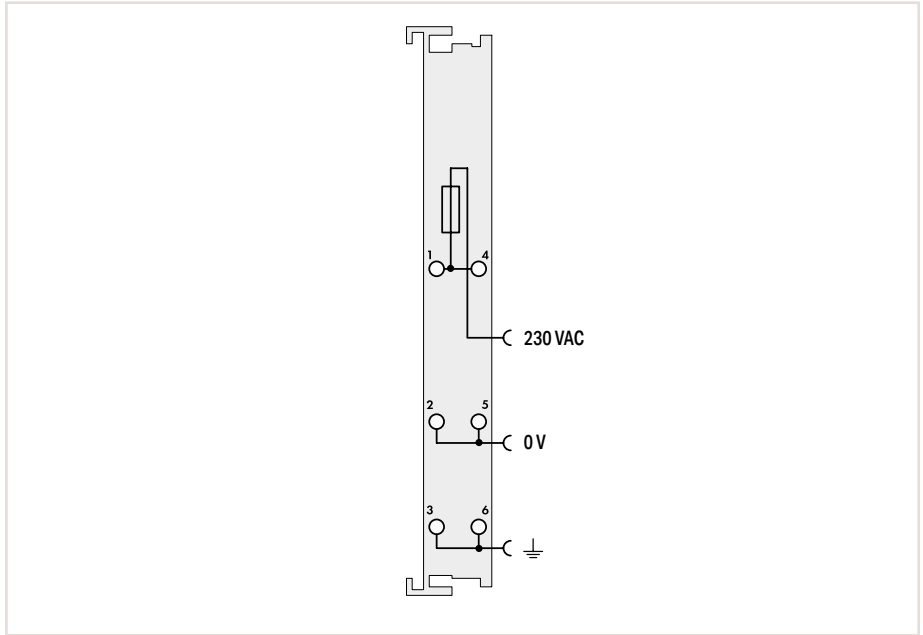
„ Mini-WSB marker card and mounting accessories, see Section “Accessories and Tools”

„ Approvals and corresponding ratings, see page 523 or [www.wago.com](http://www.wago.com)

# Power Supply; 230 VAC



Figure: 750-609

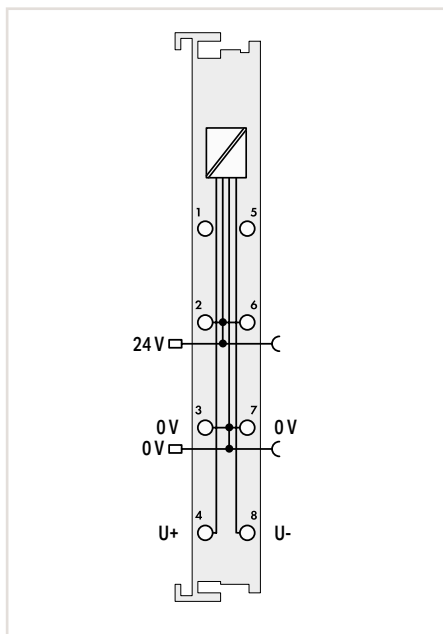
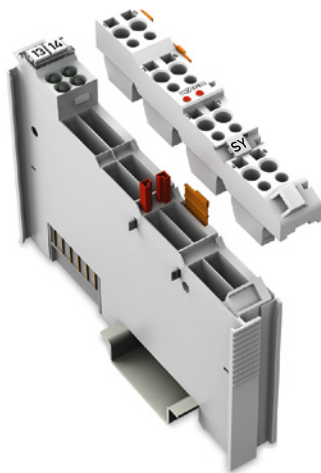


<b>Item Description</b>	<b>Power Supply; 230 VAC; Fuse holder</b>	
<b>Version</b>	<b>Standard</b>	<b>Diagnostics</b>
<b>Item No.</b>	750-609	750-611
<b>Order Text</b>	Power Supply; 230 VAC; Fuse	Power Supply; 230 VAC; Fuse; Diagn
<b>Technical Data</b>		
Supply voltage (field)	230 VAC (-15 ... +10 %); via power jumper contacts (power supply via CAGE CLAMP® connection; transmission via spring contact)	
Current carrying capacity (power jumper contacts)	6.3 A	
Fuse	5 x 20; T max. 6.3 A (not included)	
Diagnostics		Supply voltage, field: Detection "on" at > 164 VAC; Detection "off" at < 40 VAC
Current consumption – system supply (5 V)		5 mA
Data width (internal)		2 bits (1-bit current monitoring; 1-bit fuse fault)
Surrounding air temperature (operation)	0 ... +55 °C	
Dimensions W x H x D	12 x 69.8 x 100 mm	
<b>Approvals</b>	CE; Marine; OrdLoc/HazLoc; ATEX/IECEx	
<b>Data sheet and further information, see:</b>	<a href="http://wago.com/750-609">wago.com/750-609</a>	<a href="http://wago.com/750-611">wago.com/750-611</a>

This I/O module provides the applied supply voltage, protected by fuse, to the field devices connected to downstream I/O modules. A blown fuse is indicated by an LED.

This I/O module provides the applied supply voltage, protected by fuse, to the field devices connected to downstream I/O modules. A blown fuse is indicated by an LED. The fuse status can also be queried from the fieldbus coupler.

## DALI Multi-Master DC/DC Converter



<b>Item Description</b>	<b>DALI Multi-Master DC/DC Converter</b>
<b>Version</b>	<b>Pluggable (delivery without connector)</b>
<b>Item No.</b>	<b>753-620</b>
<b>Order Text</b>	DALI Multi-Master DC/DC Converter
<b>Technical Data</b>	
Pluggable connector	•
Supply voltage (field)	24 VDC (-25 ... +30 %); via power jumper contacts (power supply via blade contact; transmission via spring contact); Supply voltage (DALI): 18 VDC; at +U and -U via CAGE CLAMP® connection
Current carrying capacity (power jumper contacts)	10 A
Total current (system supply)	200 mA; short-circuit-protected
Test voltage (input/output)	1.5 kV
Surrounding air temperature (operation)	0 ... +55 °C
Dimensions W x H x D	12 x 69.8 x 100 mm
<b>Approvals</b>	CE; Marine; OrdLoc
<b>Data sheet and further information, see:</b>	<a href="http://wago.com/753-620">wago.com/753-620</a>
<b>Accessories</b>	<b>Item No.</b>
Pluggable connector	753-110
Coding keys	753-150

This I/O module powers the DALI Multi-Master (753-647). It uses the field supply, which is connected via the power jumper contacts. Cable bridges connect the module to the DALI Multi-Master.

„ Mini-WSB marker card and mounting accessories, see Section "Accessories and Tools"

„ Approvals and corresponding ratings, see page 523 or [www.wago.com](http://www.wago.com)

## Potential Distribution



Figure: 750-614

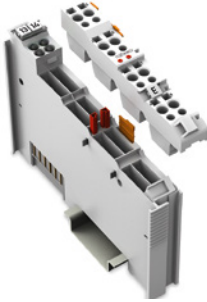
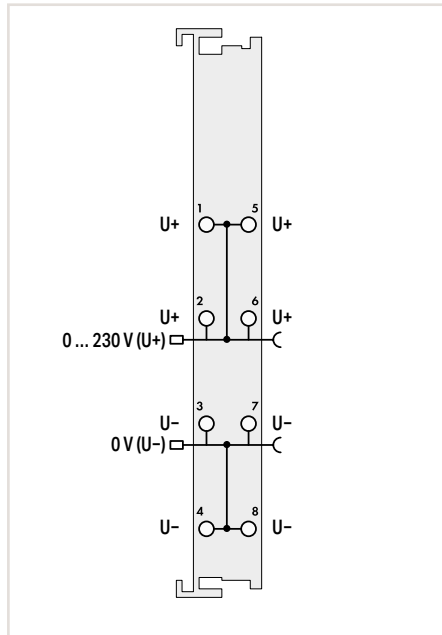


Figure: 753-614



Item Description		Potential Distribution	
Version		Standard	Pluggable (delivery without connector)
Item No.		750-614	753-614
Order Text		Potential Distribution	Potential Distribution
<b>Technical Data</b>			
Pluggable connector			•
Supply voltage (field)		0 ... 230 VAC/DC; via power jumper contacts (power supply via blade contact; transmission via spring contact)	
Current carrying capacity (power jumper contacts)		10 A	
Surrounding air temperature (operation)		0 ... +55 °C	
Dimensions W x H x D		12 x 69.8 x 100 mm	
Approvals		CE;  Marine;  OrdLoc/HazLoc;  ATEX/IECEX	
Data sheet and further information, see:		<a href="http://wago.com/750-614">wago.com/750-614</a>	<a href="http://wago.com/753-614">wago.com/753-614</a>
<b>Accessories</b>			<b>Item No.</b>
Pluggable connector			753-110
Coding keys			753-150

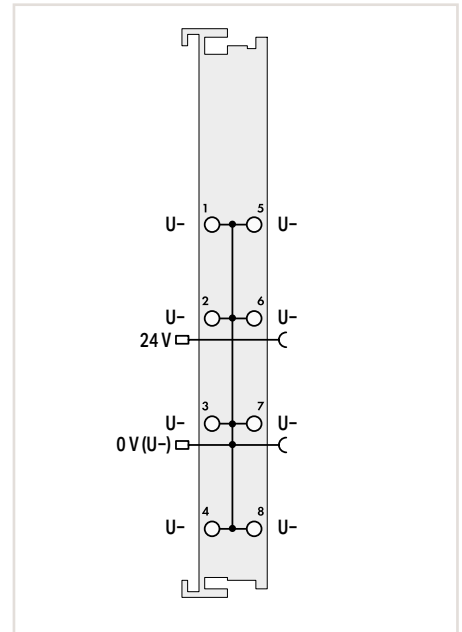
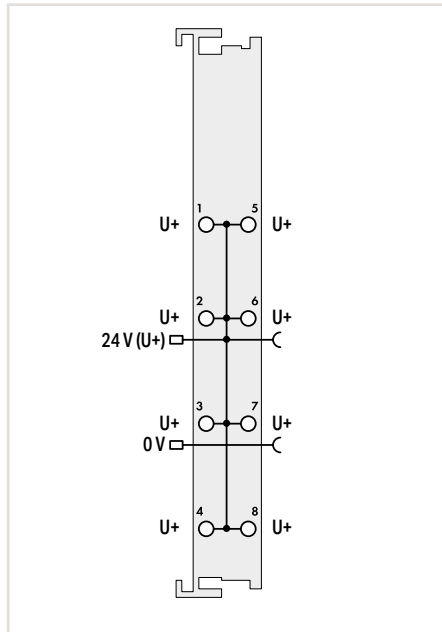
## Potential Distribution



Figure: 750-603



Figure: 750-1605

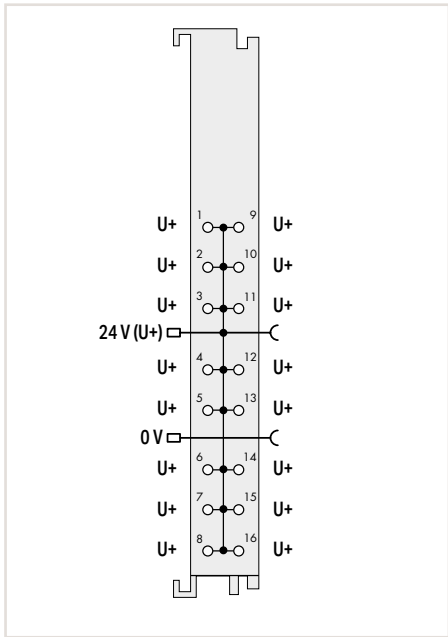


Item Description		Potential Distribution; 8x 24 V		Potential Distribution; 8x 0 V	
Version		Standard	Pluggable (delivery without connector)	Standard	Pluggable (delivery without connector)
Item No.		750-603	753-603	750-604	753-604
Order Text		Potential Distribution; 8*24V	Potential Distribution; 8*24V	Potential Distribution; 8*0V	Potential Distribution; 8*0V
<b>Technical Data</b>					
Pluggable connector			●		●
Supply voltage (field)		24 VDC (-25 ... +30 %); via power jumper contacts (power supply via blade contact; transmission via spring contact)		24 VDC (-25 ... +30 %); via power jumper contacts (power supply via blade contact; transmission via spring contact)	
Current carrying capacity (power jumper contacts)		10 A		10 A	
Surrounding air temperature (operation)		0 ... +55 °C		0 ... +55 °C	
Dimensions W x H x D		12 x 69.8 x 100 mm		12 x 69.8 x 100 mm	
Approvals		CE;  Marine;  OrdLoc/HazLoc;  ATEX/IECEX		CE;  Marine;  OrdLoc/HazLoc;  ATEX/IECEX	
Data sheet and further information, see:		<a href="http://wago.com/750-603">wago.com/750-603</a>	<a href="http://wago.com/753-603">wago.com/753-603</a>	<a href="http://wago.com/750-604">wago.com/750-604</a>	<a href="http://wago.com/753-604">wago.com/753-604</a>
<b>Accessories</b>			<b>Item No.</b>		<b>Item No.</b>
Pluggable connector			753-110		753-110
Coding keys			753-150		753-150

5.10

„ Mini-WSB marker card and mounting accessories, see Section “Accessories and Tools”

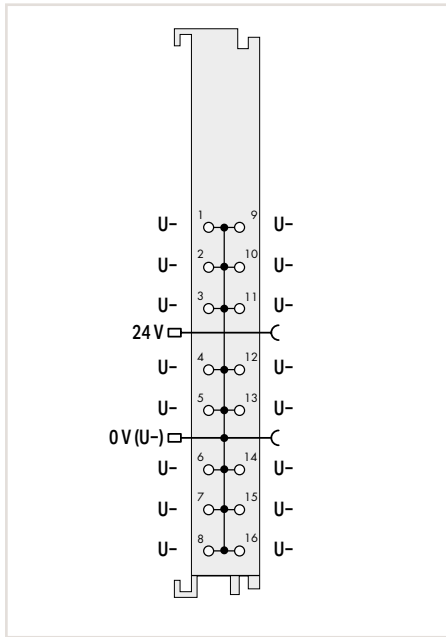
„ Approvals and corresponding ratings, see page 523 or www.wago.com



**Potential Distribution; 16x 24 V**

**Standard with 16 connectors**

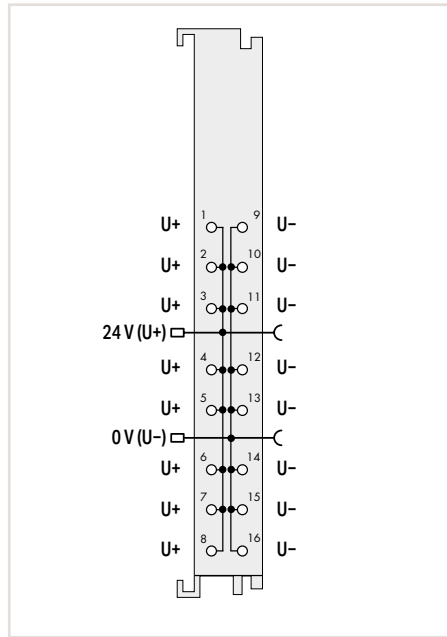
**750-1605**  
Potential Distribution; 16\*24V



**Potential Distribution; 16x 0 V**

**Standard with 16 connectors**

**750-1606**  
Potential Distribution; 16\*0V



**Potential Distribution;**  
**8x 24 V/8x 0 V**

**Standard with 16 connectors**

**750-1607**  
Potential Distribution; 8\*24V/8\*0V

24 VDC (-25 ... +30 %); via power jumper contacts (power supply via blade contact; transmission via spring contact)

10 A

0 ... +55 °C

12 x 69 x 100 mm

CE; Marine; OrdLoc/HazLoc;  
 ATEX/IECEx

[wago.com/750-1605](http://wago.com/750-1605)

24 VDC (-25 ... +30 %); via power jumper contacts (power supply via blade contact; transmission via spring contact)

10 A

0 ... +55 °C

12 x 69 x 100 mm

CE; Marine; OrdLoc/HazLoc;  
 ATEX/IECEx

[wago.com/750-1606](http://wago.com/750-1606)

24 VDC (-25 ... +30 %); via power jumper contacts (power supply via blade contact; transmission via spring contact)

10 A

0 ... +55 °C

12 x 69 x 100 mm

CE; Marine; OrdLoc/HazLoc;  
 ATEX/IECEx

[wago.com/750-1607](http://wago.com/750-1607)

5.10

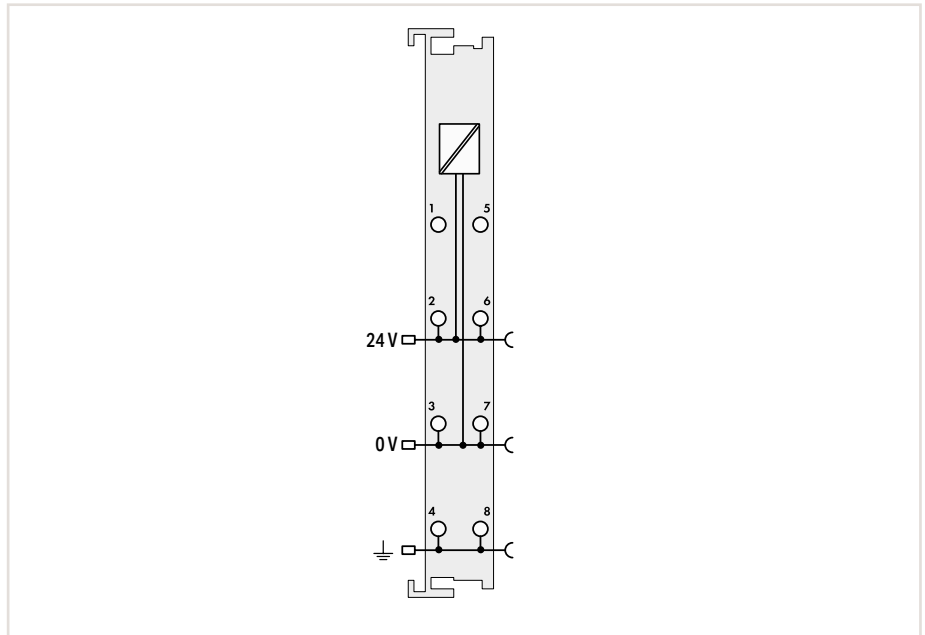
## Field Supply Filter (Surge)



Figure: 750-624/020-000



Figure: 750-624/020-001



Item Description		Field Supply Filter (Surge); 24 VDC		
Version		Standard	Higher isolation	Higher isolation; Ground fault diagnostics
Item No.		750-624	750-624/020-000	750-624/020-002
Order Text		Field Supply Filter; 24 VDC	Field Supply Filter; 24 VDC; HI	Field Supply Filter; 24 VDC HI; GF
Technical Data				
Supply voltage (field)	24 VDC (-25 ... +30 %); via power jumper contacts (power supply via blade contact; transmission via spring contact)			
Current carrying capacity (power jumper contacts)	10 A			
Use	Marine-certified operation in conjunction with the Ex i supply module and the use of 750 Series PROFIsafe Modules		Marine-certified operation in conjunction with 750 Series I/O Modules	
Ground diagnostics				Response values:
Pre-alarm				50 kΩ (±15 %)
Main alarm				25 kΩ (±15 %);
Hysteresis				typ. 25 ... 30 %;
Response time				≤5 s (typ. 2.5 s);
Internal resistance DC (test circuit)				> 10 MΩ (test inactive), > 90 kΩ (test active)
Test current				≤180 μA (R <sub>F</sub> = 0 Ω)
Permissible system leakage capacitance				≤2 μF
Surrounding air temperature (operation)	0 ... +55 °C			
Dimensions W x H x D	12 x 69.8 x 100 mm			
Approvals	CE;  Marine;  OrdLoc/HazLoc;  ATEX/IECEx			
Data sheet and further information, see:	<a href="http://wago.com/750-624">wago.com/750-624</a>	<a href="http://wago.com/750-624/020-000">wago.com/750-624/020-000</a>	<a href="http://wago.com/750-624/020-002">wago.com/750-624/020-002</a>	

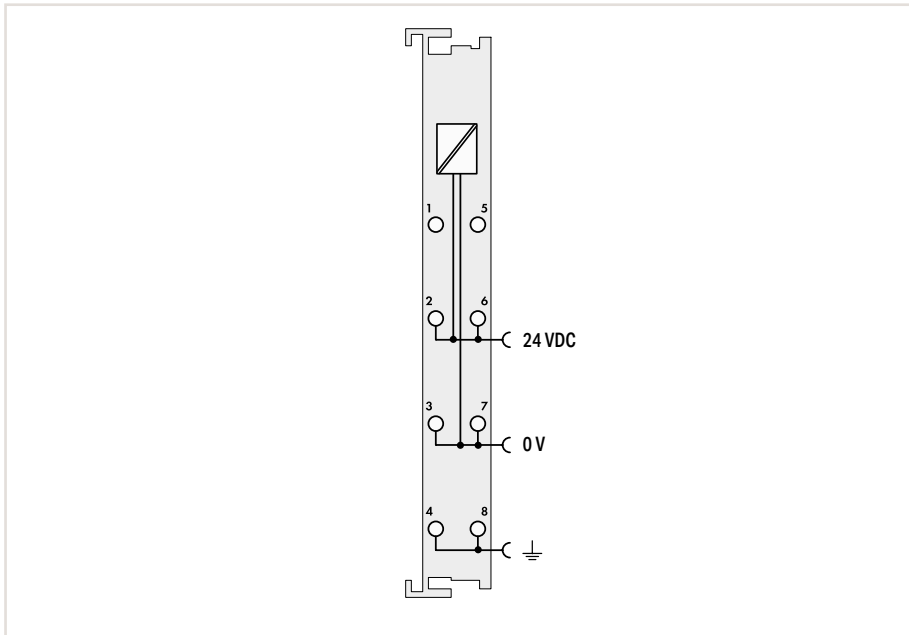
\*pending

Use in systems with isolation monitoring requires the high isolation variants.

5.10

„ Mini-WSB marker card and mounting accessories, see Section "Accessories and Tools"  
 „ Approvals and corresponding ratings, see page 523 or www.wago.com





Field Supply Filter (Surge); 24 VDC	
Without power jumper contacts	Higher isolation; Without power jumper contacts
750-624/000-001	750-624/020-001
Field Supply Filter; 24 VDC; NC	Field Supply Filter; 24 VDC; HI; NC

24 VDC (-25 ... +30 %); via power jumper contacts (power supply via CAGE CLAMP® connection; transmission via spring contact)  
10 A

Marine-certified operation in conjunction with the Ex i supply module and the use of 750 Series PROFIsafe Modules	Marine-certified operation in conjunction with 750 Series I/O Modules
---	---

0 ... +55 °C	
12 x 69.8 x 100 mm	
CE; Marine; OrdLoc/HazLoc; ATEX/IECEX	
<a href="http://wago.com/750-624/000-001">wago.com/750-624/000-001</a>	<a href="http://wago.com/750-624/020-001">wago.com/750-624/020-001</a>

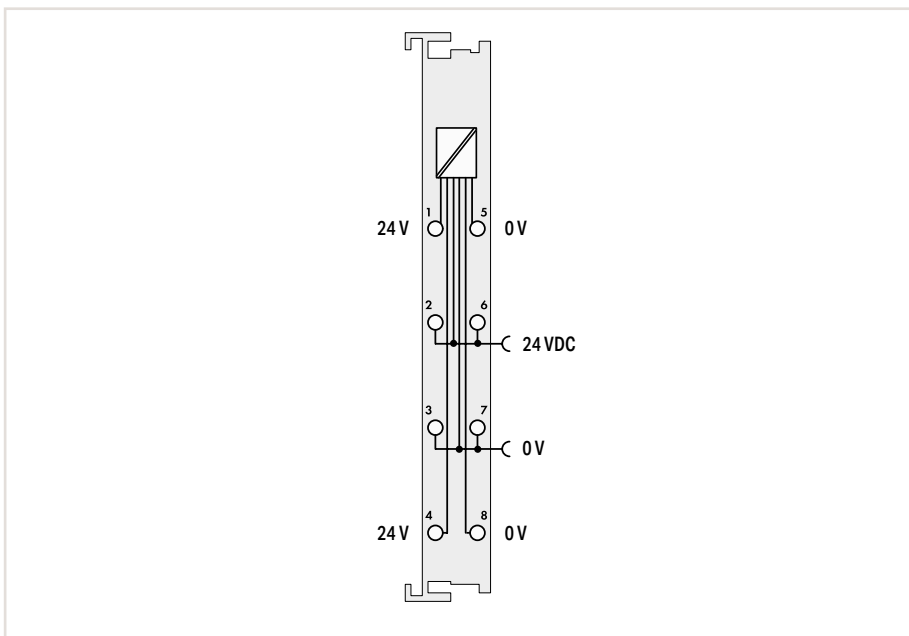
Use in systems with isolation monitoring requires the high isolation variants.

5.10

# Supply Filter



Figure: 750-626/020-000

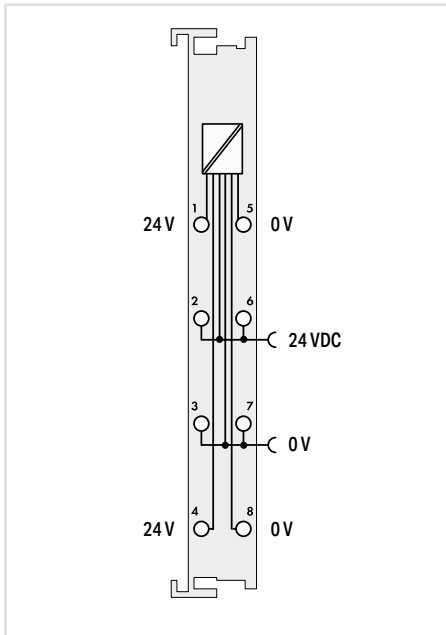


Item Description		Supply Filter; 24 VDC			
Version		Higher isolation	Higher isolation; Extended temperature	Standard	Extended temperature
Item No.		750-626/020-000	750-626/025-001	750-626	750-626/025-000
Order Text		Supply Filter; 24 VDC; HI	Supply Filter; 24 VDC; HI; T	Supply Filter; 24 VDC	Supply Filter; 24 VDC; T
<b>Technical Data</b>					
Supply voltage (field)		24 VDC (-25 ... +30 %); via power jumper contacts (power supply via CAGE CLAMP® connection; transmission via spring contact)			
Supply voltage, system (24 V)		24 VDC (-25 ... +30 %); power supply and transmission via CAGE CLAMP® connection			
Current via system voltage (max.)		1.5 A			
Current carrying capacity (power jumper contacts)		10 A			
Use		Marine-certified operation in conjunction with 750 Series Couplers and Controllers		Marine-certified operation in conjunction with the Ex i supply module and the use of 750 Series PROFIsafe Modules	
Ground diagnostics					
Pre-alarm					
Main alarm					
Hysteresis					
Response time					
Internal resistance DC (test circuit)					
Test current					
Permissible system leakage capacitance					
Surrounding air temperature (operation)		0 ... +55 °C	-20 ... +60 °C	0 ... +55 °C	-20 ... +60 °C
Dimensions W x H x D		12 x 69.8 x 100 mm			
Approvals		CE; Marine; OrdLoc/HazLoc; ATEX/IECEx			
Data sheet and further information, see:		<a href="http://wago.com/750-626/020-000">wago.com/750-626/020-000</a>		<a href="http://wago.com/750-626">wago.com/750-626</a>	

Use in systems with isolation monitoring requires the high isolation variants.

5.10

„ Mini-WSB marker card and mounting accessories, see Section "Accessories and Tools"  
 „ Approvals and corresponding ratings, see page 523 or [www.wago.com](http://www.wago.com)



**Supply Filter; 24 VDC**

**Higher isolation; Ground fault diagnostics**

**750-626/020-002**

Supply Filter; 24 VDC HI; GF

24 VDC (-25 ... +30 %); via power jumper contacts  
(power supply via CAGE CLAMP® connection;  
transmission via spring contact)

24 VDC (-25 ... +30 %); power supply and transmission via CAGE CLAMP® connection

1.5 A

10 A

Marine-certified operation in conjunction with  
750 Series Couplers and Controllers

Response values:

50 kΩ (±15 %)

25 kΩ (±15 %);

typ. 25 ... 30 %;

≤5 s (typ. 2.5 s);

> 10 MΩ (test inactive), > 90 kΩ (test active)

≤ 180 μA ( $R_F = 0 \Omega$ )

≤ 2 μF

0 ... +55 °C

12 x 69.8 x 100 mm

CE; Marine; OrdLoc; ATEX/IECEx

[wago.com/750-626/020-002](http://wago.com/750-626/020-002)

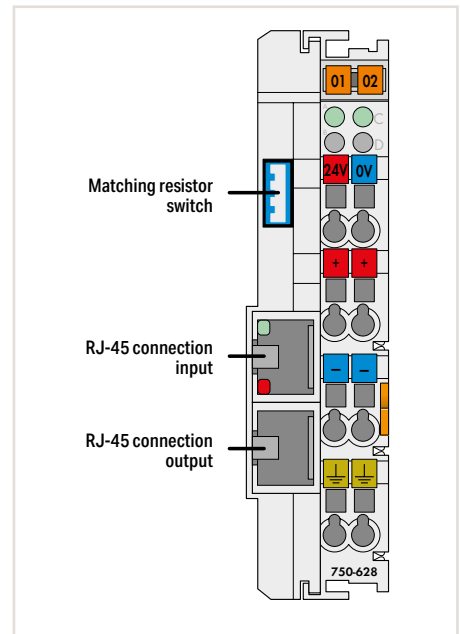
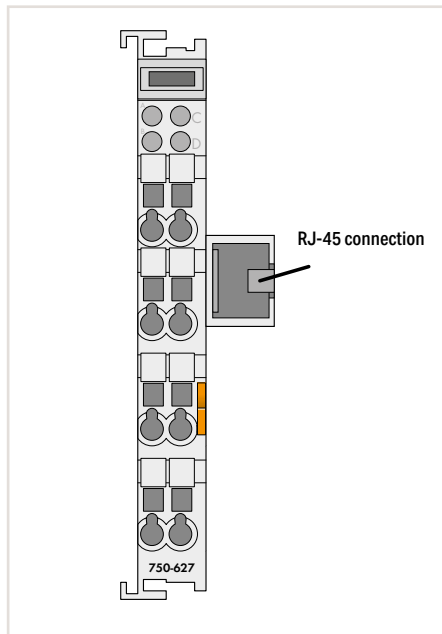
Use in systems with isolation monitoring requires  
the high isolation variants.

## End Module/Coupler Module for Bus Extension

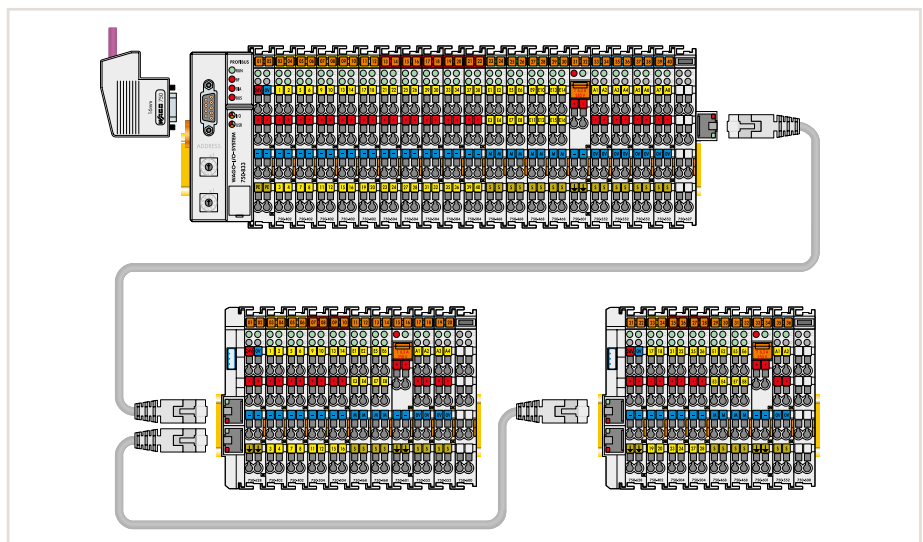


Figure: 750-627

Figure: 750-628

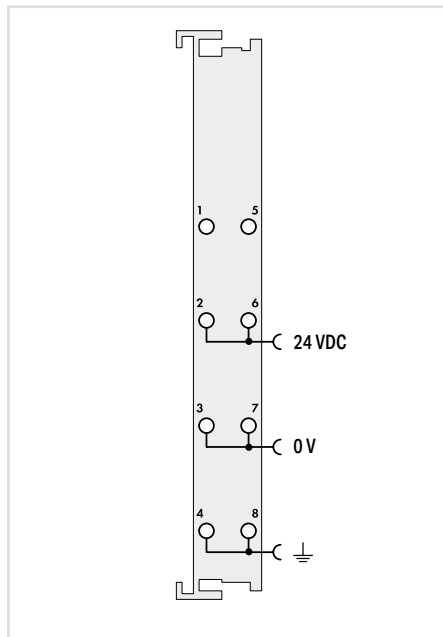


Item Description	Bus Extension End Module	Bus Extension Coupler Module
Version	Standard	Standard
Item No.	750-627	750-628
Order Text	Bus Extension End Module	Bus Extension Coupler Module
<b>Technical Data</b>		
Number of coupler modules	Up to 10	
Number of I/O modules		64 (within the system)
Connection technology (local bus)	1 x RJ-45 socket	2 x RJ-45 socket (input + output)
Distance (max.)	5 m (10 m see manual); (end/coupler modules or coupler/coupler modules)	5 m (10 m see manual); (end/coupler modules or coupler/coupler modules)
Supply voltage (field)		24 VDC (-15 ... +20 %); via power jumper contacts (power supply via CAGE CLAMP® connection; transmission via spring contact)
Supply voltage, system (24 V)		24 VDC (-15 ... +20 %); power supply and transmission via CAGE CLAMP® connection
Current consumption – system supply (5 V)	70 mA	150 mA
Current carrying capacity (power jumper contacts)		10 A
Isolation	500 V system/field	500 V system/field
Surrounding air temperature (operation)	0 ... +55 °C	0 ... +55 °C
Dimensions W x H x D	24 x 69.8 x 100 mm	24 x 69.8 x 100 mm
Approvals	CE;  Marine;  OrdLoc	CE;  Marine;  OrdLoc
Data sheet and further information, see:	<a href="http://wago.com/750-627">wago.com/750-627</a>	<a href="http://wago.com/750-628">wago.com/750-628</a>



„ Mini-WSB marker card and mounting accessories, see Section “Accessories and Tools”  
 „ Approvals and corresponding ratings, see page 523 or [www.wago.com](http://www.wago.com)

## Binary Spacer Module



<b>Item Description</b>	<b>Binary Spacer Module</b>
<b>Version</b>	<b>Standard</b>
<b>Item No.</b>	<b>750-622</b>
<b>Order Text</b>	Binary Spacer Module
<b>Technical Data</b>	
Current consumption – system supply (5 V)	10 mA
Supply voltage (field)	24 VDC (-15 ... +20 %); via power jumper contacts (power supply via CAGE CLAMP® connection; transmission via spring contact)
Current carrying capacity (power jumper contacts)	10 A
Data width (internal)	2; 4; 6 or 8 bits (adjustable via DIP switches)
Operating mode	Inputs/outputs (adjustable via DIP switches)
Isolation	500 V system/field
Surrounding air temperature (operation)	0 ... +55 °C
Dimensions W x H x D	12 x 69.8 x 100 mm
<b>Approvals</b>	CE;  OrdLoc/HazLoc;  ATEX/IECEx
<b>Data sheet and further information, see:</b>	<a href="http://wago.com/750-622">wago.com/750-622</a>

This binary spacer module reserves bit addresses in the process image of a fieldbus node.

# Spacer Module

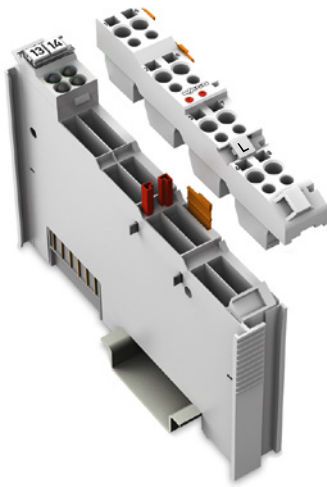
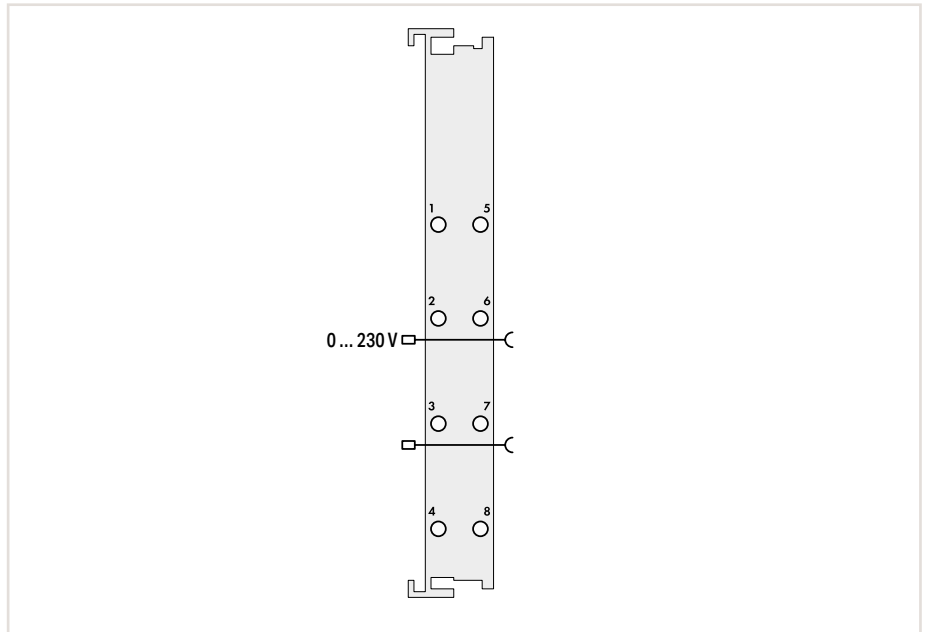


Figure: 753-1629



5.10

Item Description	Spacer Module		
Version	Active; Pluggable (delivery without connector)	Active; Without power jumper contacts; Pluggable (delivery without connector)	Passive; Pluggable (delivery without connector)
Item No.	753-1629	753-1629/000-001	753-629/020-000
Order Text	Spacer Module; Active	Spacer Module; Active; NC	Spacer Module; Passive

Technical Data	0 ... +55 °C	
Supply voltage (field)	0 ... 230 VAC/DC; Field-side supply via power jumper contacts	0 ... 230 VAC/DC; Field-side supply via power jumper contacts
Surrounding air temperature (operation)	0 ... +55 °C	
Dimensions W x H x D	12 x 69.8 x 100 mm	
Approvals	CE, RoHS, OrdLoc	
Data sheet and further information, see:	<a href="http://wago.com/753-1629">wago.com/753-1629</a>	<a href="http://wago.com/753-629">wago.com/753-629</a>

This active spacer module enables both hardware and software space reservation for standard function modules (digital input/output modules and analog input/output modules) in PROFIBUS/PROFINET networks (only in conjunction with 750-333, 750-375, 750-377).

This passive spacer module enables hardware space reservation for standard function modules (digital input/output modules and analog input/output modules).

„ Mini-WSB marker card and mounting accessories, see Section “Accessories and Tools”

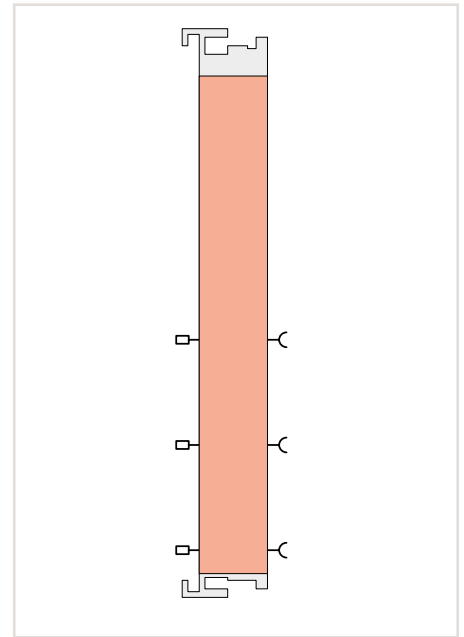
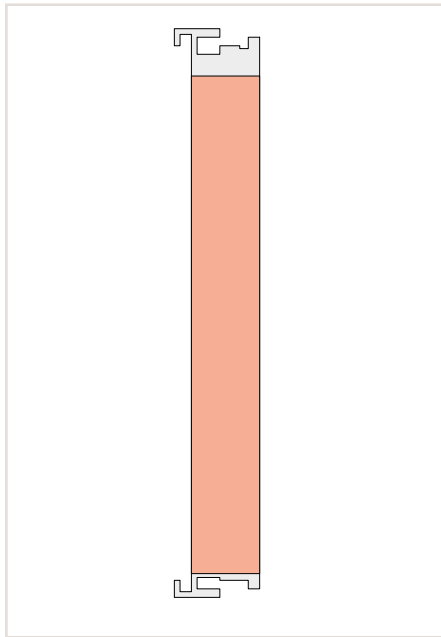
„ Approvals and corresponding ratings, see page 523 or www.wago.com

## Distance Module



Figure: 750-616

Figure: 750-616/030-000



Item Description
Version
Item No.
Order Text

Technical Data
Surrounding air temperature (operation)
Dimensions W x H x D

Approvals
-----------

Data sheet and further information, see:

Distance Module	
Standard	Labeled
750-616	750-616/030-000
Distance Module	Distance Module

0 ... +55 °C
12 x 69.8 x 100 mm
CE;  Marine;  OrdLoc/HazLoc; ATEX/IECEX
<a href="http://wago.com/750-616">wago.com/750-616</a>

This distance module visually divides a fieldbus node into sections.

The 750-616 Distance Module has no power jumper contacts. The labeled version of the distance module is available under the item number 750-616/030-000.

Notice:  
Operation of the adjacent I/O modules requires a supply module.

Distance Module
With power jumper contacts
750-621
Distance Module

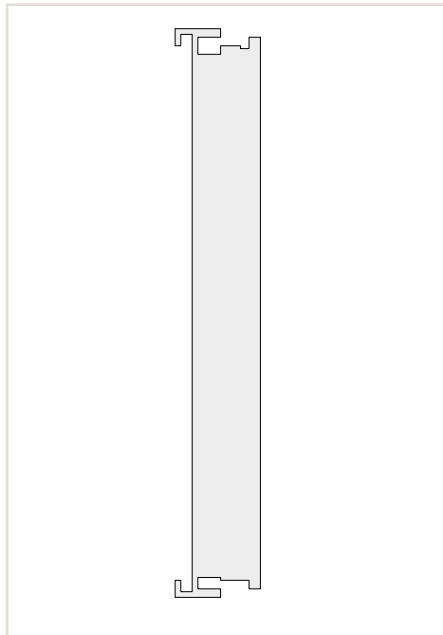
0 ... +55 °C
12 x 69.8 x 100 mm
CE;  Marine;  OrdLoc/HazLoc; ATEX/IECEX
<a href="http://wago.com/750-621">wago.com/750-621</a>

The 750-621 Distance Module has power jumper contacts that can supply the power to adjacent I/O modules.

## End Module



Figure: 750-600



Item Description		End Module	
Version		Standard	Extended temperature
Item No.		750-600	750-600/025-000
Order Text		End Module	End Module; T
<b>Technical Data</b>			
Surrounding air temperature (operation)		0 ... +55 °C	-20 ... +60 °C
Dimensions W x H x D		12 x 69.8 x 100 mm	
<b>Approvals</b>			
Data sheet and further information, see:		CE;  Marine;  OrdLoc/HazLoc; ATEX/IECEX <a href="http://wago.com/750-600">wago.com/750-600</a>	

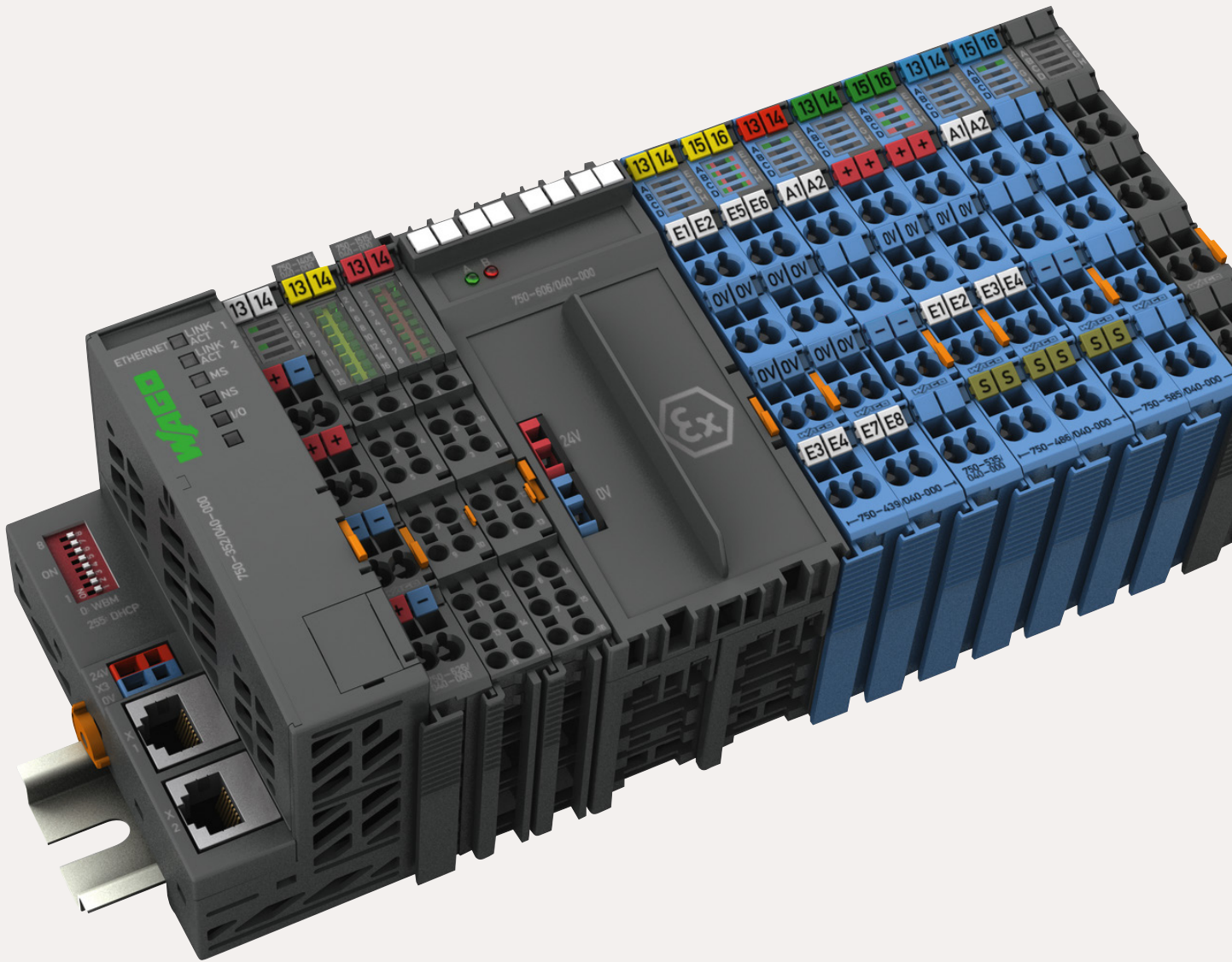
This end module must be snapped onto the assembly at the end of a fieldbus node. The end module completes the internal data bus, ensuring flawless data transmission.

„ Mini-WSB marker card and mounting accessories, see Section "Accessories and Tools"

„ Approvals and corresponding ratings, see page 523 or [www.wago.com](http://www.wago.com)



5.10



# I/O System – 750 XTR Series

## I/O System – 750 and 753 Series











- Highly versatile
- More than 500 modules available
- Functional safety
- Ex i

## I/O System – 750 XTR Series

- For demanding applications in which the following are critical:
- Extreme temperature stability
  - Immunity to electromagnetic interference and impulse voltages
  - Vibration and shock resistance

# I/O System – 750 XTR Series

## Contents

		Page	
	<b>General Product Information</b>	346	
	<b>Interfaces and Types</b>	347	
	<b>Application and Installation Instructions</b>	348	
	<b>Standards and Rated Conditions for Rail Applications (EN 50155)</b>	350	
	<b>Standards and Rated Conditions</b>	351	
	<b>Item Number Key</b>	350	
	<b>Approvals</b>	350	
	<b>Controllers PFC200 XTR</b>	see Section 4.2	
	<b>Controllers 750 XTR</b>	see Section 4.4	
	<b>Description</b>	<b>Item No.</b>	
	<b>Fieldbus Couplers</b>		
	Fieldbus Coupler PROFIBUS DP; 2nd generation; 12 MBd; extreme	750-333/040-000 352	
	Fieldbus Coupler ETHERNET; 3rd generation; extreme	750-352/040-000 353	
	Fieldbus Coupler CANopen; D-Sub; extreme	750-338/040-000 354	
	<b>Digital Input Modules</b>		
	8-Channel Digital Input; 24 VDC; 3 ms; 2-wire connection; extreme	750-1415/040-000 355	
	8-Channel Digital Input; 24 VDC; 3 ms; extreme	750-430/040-000 355	
	16-Channel Digital Input; 24 VDC; 3 ms; extreme	750-1405/040-000 356	
	8-Channel Digital Input; 24 VDC; 0.2 ms; 2-wire connection; extreme	750-1416/040-000 357	
	8-Channel Digital Input; 24 VDC; 0.2 ms; extreme	750-431/040-000 357	
	2-Channel Digital Input; 60 VDC; 3 ms; extreme	750-429/040-001 358	
2-Channel Digital Input; 110 VDC; 3 ms; extreme	750-427/040-000 358		
	2-Channel Digital Input; 220 VDC; 3 ms; extreme	750-407/040-000 359	
	<b>Digital Output Modules</b>		
	2-Channel Digital Output; 24 VDC; 2.0 A; Diagnostics; extreme	750-508/040-000 360	
	8-Channel Digital Output; 24 VDC; 0.5 A; Diagnostics; extreme	750-537/040-000 360	
	8-Channel Digital Output; 24 VDC; 0.5 A; 2-wire connection; extreme	750-1515/040-000 361	
	2-Channel Relay Output; 250 VAC; 1 A; Relay with 2 changeover contacts; extreme	750-517/040-000 362	
	<b>Analog Input Modules</b>		
	4-Channel Analog Input; 0 ... 20 mA; single-ended; extreme	750-453/040-000 363	
	4-Channel Analog Input; 4 ... 20 mA; single-ended; extreme	750-455/040-000 363	
	2-Channel Analog Input; 4 ... 20 mA; Differential input; NAMUR NE 43; extreme	750-492/040-001 364	
	4-Channel Analog Input; 0 ... 10 VDC; single-ended; extreme	750-468/040-000 365	
	4-Channel Analog Input; ±10 VDC; single-ended; extreme	750-457/040-000 365	
	2-Channel Analog Input; 0 ... 30 VDC; Differential input; extreme	750-483/040-000 366	
	2/4-Channel Analog Input; Resistance measurement; adjustable; extreme	750-464/040-000 367	
	2-Channel Analog Input; Thermocouple; adjustable; extreme	750-469/040-000 367	
	3-Phase Power Measurement; 690 VAC 1 A; extreme	750-495/040-000 368	
	3-Phase Power Measurement; 690 VAC 5 A; extreme	750-495/040-001 368	
	3-Phase Power Measurement; 690 VAC Rogowski coils; extreme	750-495/040-002 368	
		<b>Analog Output Modules</b>	
2-Channel Analog Output; 0/4 ... 20 mA; 16 bits; 6 ... 18 VDC; extreme		750-563/040-000 369	
4-Channel Analog Output; ±10 VDC; extreme		750-557/040-000 370	
	4-Channel Analog Output; 0 ... 10 VDC; extreme	750-559/040-000 370	
	<b>Function/Technology Modules</b>		
	Counter; adjustable; extreme	750-404/040-003 371	
	SSI Transmitter Interface; adjustable; extreme	750-630/040-001 372	
	Incremental Encoder Interface; 24 VDC; Differential input; 32 bits; extreme	750-637/040-001 373	
	<b>Communication Modules</b>		
	Serial Interface RS-232/485; extreme	750-652/040-000 374	
	CAN Gateway; extreme	750-658/040-000 375	
	<b>Supply/Segment Modules</b>		
	Power Supply; 24 VDC; extreme	750-602/040-000 376	
	Power Supply; 24 VDC; Fuse holder; extreme	750-601/040-000 376	
	Power Supply; 24 VDC; Fuse holder; Diagnostics; extreme	750-610/040-000 377	
	Power Supply; 0 ... 230 VAC/DC; extreme	750-612/040-000 377	
	System Power Supply; 24 VDC; extreme	750-613/040-000 377	
	Potential Distribution; 16x 24 V; extreme	750-1605/040-000 378	
	Potential Distribution; 16x 0 V; extreme	750-1606/040-000 378	
	Potential Distribution; 0 ... 230 VAC/DC; extreme	750-614/040-000 379	
	Field Supply Filter (Surge); 24 VDC; Higher isolation; extreme	750-624/040-000 380	
	Field Supply Filter (Surge); 24 VDC; Higher isolation; without power jumper contacts; extreme	750-624/040-001 380	
	Supply Filter; 24 VDC; Higher isolation; extreme	750-626/040-000 381	
	Distance Module; extreme	750-616/040-000 382	
	End Module; extreme	750-600/040-000 383	
		Power Supply; 24 VDC; extreme; for intrinsically safe XTR modules	750-606/040-000 385
		<b>Intrinsically Safe XTR Modules</b>	
8-Channel Digital Input; NAMUR; intrinsically safe; extreme		750-439/040-000 386	
2-Channel Digital Output; 24 VDC; intrinsically safe; extreme		750-535/040-000 387	
4-Channel Analog Input; 0/4 ... 20 mA; intrinsically safe; extreme		750-486/040-000 388	
2-Channel Analog Input; 4 ... 20 mA HART; intrinsically safe; extreme		750-484/040-000 389	
2-Channel Analog Input; Resistance measurement; intrinsically safe; extreme		750-481/040-000 390	
2-Channel Analog Output; 0 ... 20 mA; intrinsically safe; extreme		750-585/040-000 391	
	Up/Down Counter; intrinsically safe; extreme	750-633/040-000 392	
	<b>Accessories</b>	Section 10	
	<b>Marking and Mounting Accessories</b>		

## I/O System – 750 XTR Series

### General Product Information

#### Taking It to the eXTReme — The Standard for 750 XTR

Instantly recognizable by its dark gray modules, the WAGO-I/O-SYSTEM 750 XTR's unique features make it ideal for extreme environments.

Extremely temperature-resistant, immune to interference, as well as unfazed by vibrations and impulse voltages – WAGO's 750 XTR is the first choice for demanding applications including:

- Marine systems and onshore/offshore industry
- Renewable energy systems (wind turbines, solar systems and biogas plants)
- Transformer stations and power distribution systems
- Petrochemical processing
- Water and wastewater treatment systems
- Custom machines
- Railway applications

#### Superior Reliability in Extreme Climates

Automation systems are increasingly being located in outdoor and remote locations where components are directly affected by widely fluctuating temperature conditions such as wind turbines or transformer stations.

Engineered for freezing cold, extreme heat and high humidity, the WAGO-I/O-SYSTEM 750 XTR provides absolute dependability in virtually any weather. The XTR version of the WAGO-I/O-SYSTEM 750 is unfazed by both freezing cold down to  $-40^{\circ}\text{C}$  and scorching heat up to  $+70^{\circ}\text{C}$ . And this applies equally for both start-up and ongoing operation. The maximum approved operating altitude of 5,000 m is another highlight. Even in the thin air of a mountain-top station, the system impressively demonstrates its high performance and availability.

#### eXTReme Evolution of the Tried and Tested

Using an industry-leading platform, the WAGO-I/O-SYSTEM 750 XTR boasts the same proven benefits:

- Compact design: up to 16 channels in a module width of 12 mm (1/2")
- Easy to Use
- Vibration-proof, fast and maintenance-free CAGE CLAMP® spring connections
- Fieldbus independence due to its modular design
- Clear identification with the WAGO WSB Marking System

#### Additional Protection Against Interference Pulses

The WAGO-I/O-SYSTEM 750 XTR provides greater isolation up to 5 kV of impulse voltage, lower EMC emission of interference and higher insensitivity to EMC interference. These strengths add up to trouble-free operation.

#### High Mechanical Performance

Automation systems must be incredibly vibration-resistant, especially when installed close to vibration-prone and shock-generating system components. Powerful motors and power circuit breakers are just two examples from a wide range of applications that can stress automation systems. In order to perform in these demanding environments, the WAGO-I/O-SYSTEM 750 XTR was developed to set new standards. With 5g of vibration resistance up to an acceleration of  $50\text{ m/s}^2$  per DIN EN 60068-2-6 and shock resistance of 15g ( $150\text{ m/s}^2$ ), as well as 25g ( $250\text{ m/s}^2$ ) of shock resistance per IEC 60068-2-27, the system is engineered for dependability – no matter what. Count on long-lasting, trouble-free operation and industry-topping levels of safety – even in the most severe applications, such as tunnel boring machines.

#### Worldwide Approvals

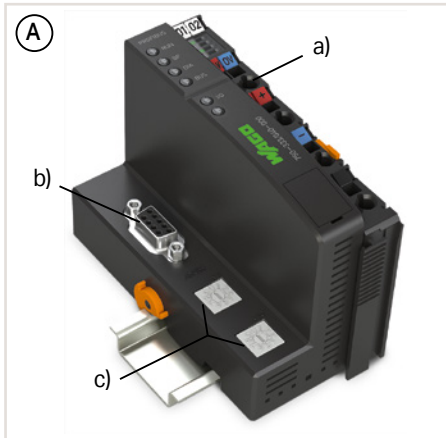
International approvals for industrial automation, shipbuilding and onshore/offshore applications guarantee worldwide use even under the harshest operating conditions, e.g., Germanischer Lloyd, Det Norske Veritas, American Bureau of Shipping, Korean Register of Shipping, Nippon Kaiji Kyokai, Registro Italiano Navale, Polski Rejestr Stratkow.



#### Advantages:

- No need for air conditioning
  - Takes less space
  - Lower energy and maintenance costs
- Can be used in unshielded areas
- Maximum system uptime
- Install close to vibrating and shock-generating system components
- Vibration-proof, fast and maintenance-free CAGE CLAMP® connections

## I/O System – 750 XTR Series Interfaces and Types

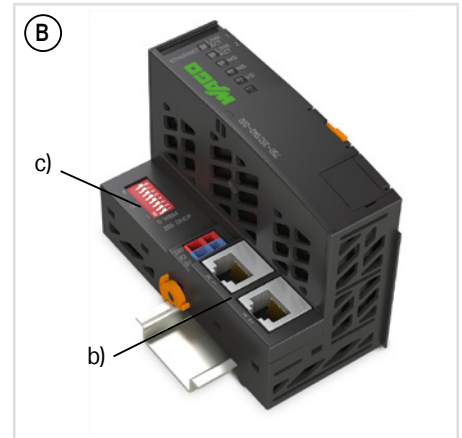


### Housing design: fieldbus coupler (A)

- Including supply module (a) to power downstream I/O modules
- Technical differences on the connection level; fieldbus interface (b) and optional addressing switch (c)
- W x H x D (mm) 50.5 x 71.1 x 100

### Housing design: fieldbus coupler Eco (B)

- Restriction on power supply and data width
- W x H x D (mm) 49.5 x 71.9 x 96.8



### Housing design: 750 (C)

- 8 connection points (CAGE CLAMP®)
- W x H x D (mm) 12 x 67.8 x 100

### Housing design: 750 (D)

- 16 connection points (Push-in CAGE CLAMP®)
- W x H x D (mm) 12 x 69 x 100

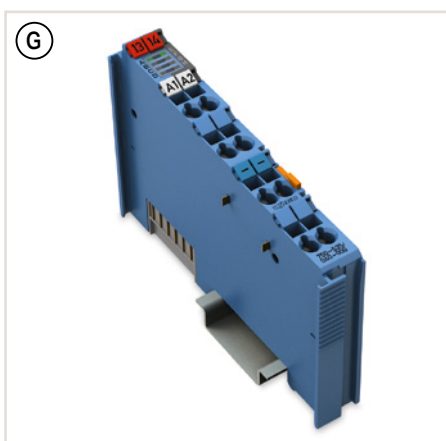


### Housing design: double width (G)

- Some modules are integrated into a double housing to address specific technological needs. Despite utilizing the same standardized housing, these modules are twice as wide.
- W x H x D (mm) 24 x 67.8 x 100

### Specialty housing design (H)

- Some modules are integrated into a specialty housing with a specific width and pluggable connectors. The dimensions are specified on the respective catalog pages.

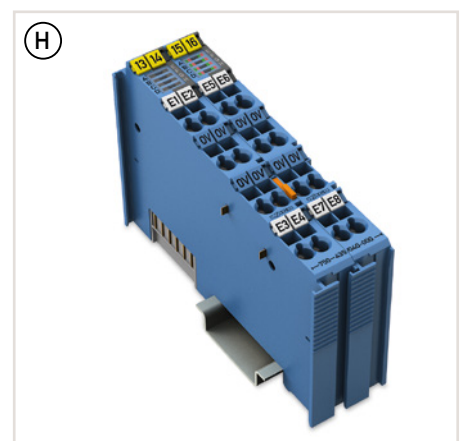


### Housing design: intrinsically safe XTR modules (G)

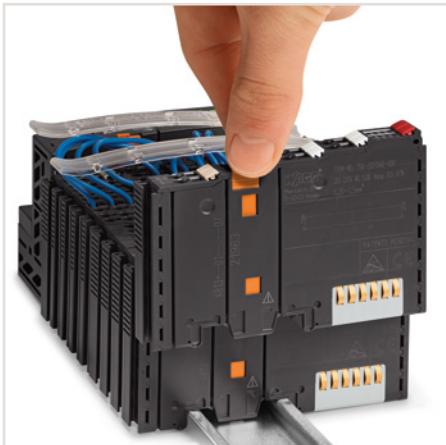
- 8 connection points (CAGE CLAMP®)
- W x H x D (mm) 12 x 67.8 x 100

### Housing design (intrinsically safe XTR modules): double width (H)

- 16 connection points (CAGE CLAMP®)
- W x H x D (mm) 24 x 67.8 x 100



## I/O System – 750 XTR Series Application and Installation Instructions



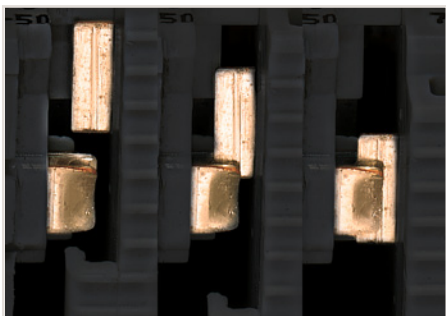
Securing/removing a module from the mounting rail



Secure, automatic data and electronics power supply connection via gold-plated pressure contacts



Service interface for configuring the fieldbus coupler; connectivity via configuration cable or radio adapter

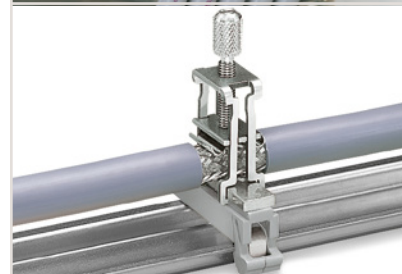


Secure, automatic power supply connection via self-cleaning blade contacts

**Notice:**

For some I/O modules, not all power jumper contacts are made! An I/O module with three power jumper contacts (e.g., 2-channel digital input) cannot be snapped into place behind a module in which not every contact is made.

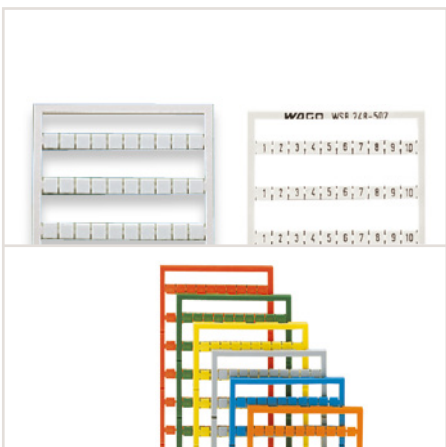
To increase electromagnetic compatibility (EMC), some components are connected to the DIN-rail by a discharge contact. The DIN-rail must always have a low-resistance connection to the ground potential.



Wide range of accessories available for EMC-compliant installation, including shield connection

6

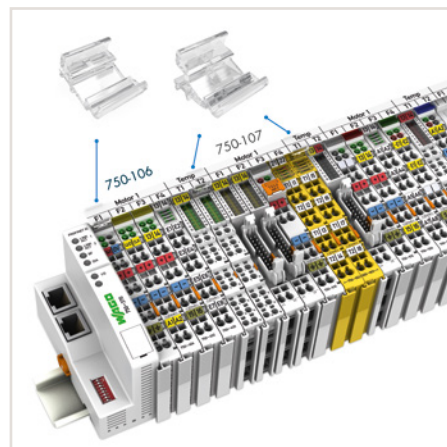
### Marking Accessories



Mini-WSB Quick Marking System, blank, pre-marked and colored; suitable for all 750 Series I/O Modules.



Marker carrier for one single I/O module (suitable for all 750 and 753 Series I/O Modules); the marker carrier can be accommodated in the upper Mini-WSB marker slot.



Marker carrier for one I/O node; both carrier models (750-106 and 750-107) permit continuous marking regardless of the I/O module housing used.

# I/O System – 750 XTR Series

## Application and Installation Instructions

### Power Supply

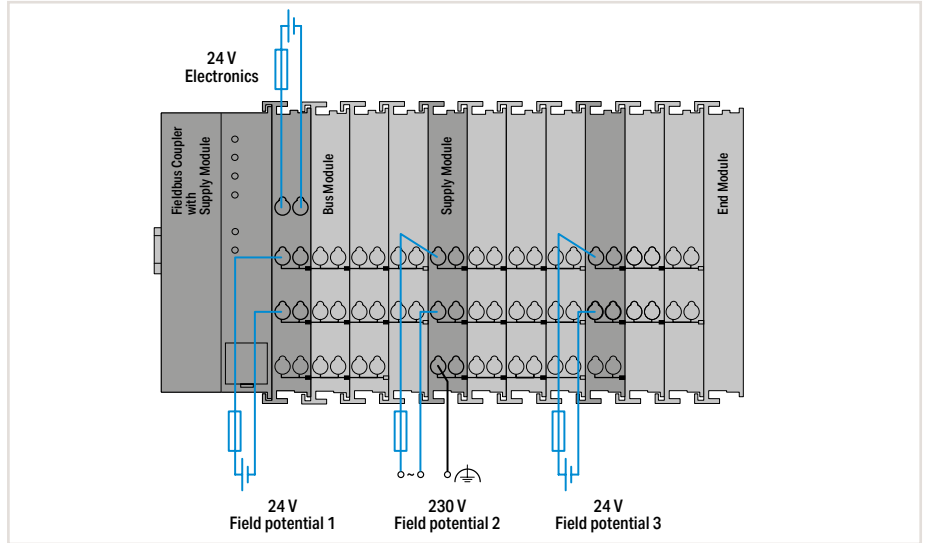
The internal electronics are powered by the fieldbus coupler. The power supply to the field-side supply is electrically isolated. This division enables a separate supply for sensors and actuators. Snapping the I/O modules together automatically routes the supply voltages. Supply modules with diagnostics also enable power supply monitoring. This ensures a flexible, user-specific supply design for a station.

Power supply to the electronics is limited by a maximum value. This value depends on the fieldbus coupler used. If the sum of the internal current demand of all the I/O modules should exceed this value, an additional system supply module is necessary. Even in this case, power supply to the field-side supply of 10 A may not be exceeded. However, different power supply modules allow a new power supply, formation of potential groups and the implementation of emergency stops.

### Interference-Free in Safety-Related Applications

To easily and safely perform cost-effective, centralized deactivation of complete actuator groups, the actuator's power supply can be switched off using a safety switching device. This can either be performed for each individual actuator or by turning off the power supply to a group of control outputs. In the event of failure, ensure that no interference from other current or power circuits occurs – even when the control voltage is switched off – so the defined safety function properties (logic and time response) remain unchanged.

All 750 XTR Series Digital Output Modules are designed to provide interference-free safety functionality. The modules can be used in safety applications up to category 4 per DIN EN ISO 13849-1:2007. Safety category and performance level depend solely on the safety components and their wiring.



### Notice:

WAGO's interference-free I/O modules are not a component of the safety function and do not replace the safety switching device! When using the components in safety functions, the corresponding notes must be observed in the relevant manual.

### Notes

Additional steps must be implemented based on where the I/O system is installed: Specific power and field-side power supply filters (750-624/040-001 or 750-626/040-000) are required for marine and onshore/offshore applications, as well as in telecontrol and rail technology.

A specific supply module (750-606/040-000) is required to operate intrinsically safe Ex i modules.

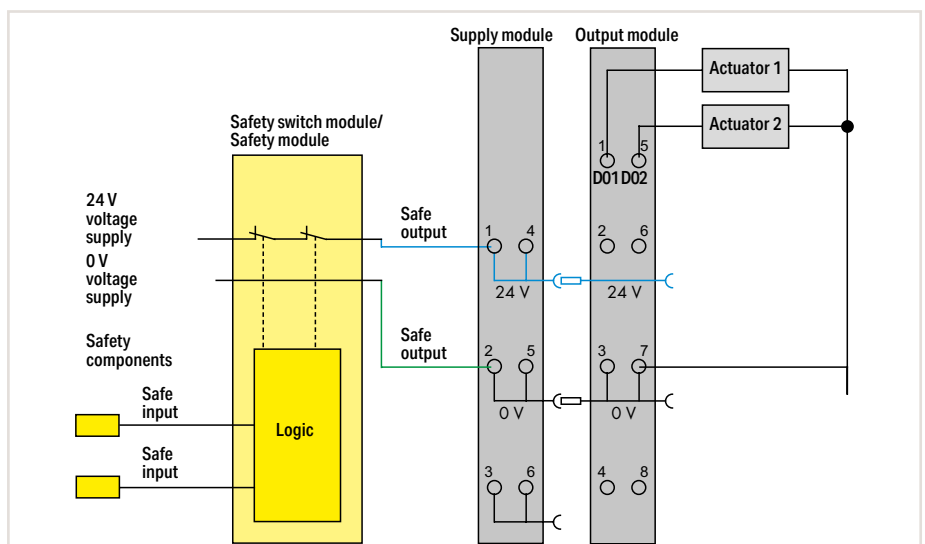
Additionally, both supply modules and a field-side power supply filters are recommended

when operating intrinsically safe Ex i modules for marine and onshore/offshore applications.

Please refer to the manual for details about the power supply's design.

### Mixed Operation

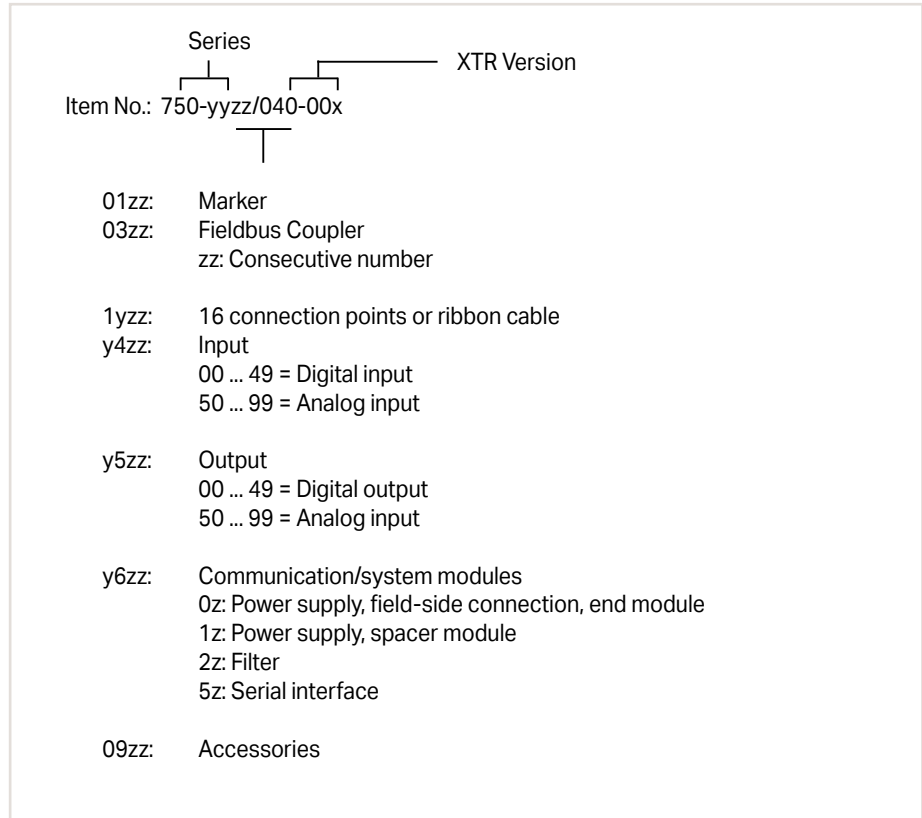
Mixed operation (standard/XTR modules) within a node is possible when groups of I/O modules are electrically isolated on the field side, i.e., electrically isolated power supply. The combination may be useful, for example, when there are only increased requirements for dielectric strength and immunity to interference, but the surrounding air temperature is not critical.



Example: 2-channel, double-pole power supply disconnection

## I/O System – 750 XTR Series Item Number Key

Explanation of item number key's components



## Approvals

Overview of the approvals in the item comparison in Section 11, Technical Section, or online under [www.wago.com](http://www.wago.com)



# 6

## Standards and Rated Conditions for Rail Applications (EN 50155), not for Intrinsically Safe XTR Modules

Railway Applications (EN 50155)	Class/Standard Compliance
<b>4.1 Rated operating conditions</b>	
4.1.1 Altitude above sea level	AX (EN 50125-1)
4.1.2 Surrounding air temperature	TX
4.1.3 Shock and vibration	1A and 1B (EN 61373)
4.1.4 Relative humidity	95 % (coated PCBs)
<b>5.1 Power supply</b>	
5.1.1.1 Master voltage fluctuations	
Minimum voltage	0.725 x Un
Maximum voltage	1.3 x Un
5.1.1.2 Power interruptions	S1
<b>5.4 Surge, ESD, burst tests</b>	EN 50121-3-2
<b>5.5 EMC (emission of interference, immunity to interference)</b>	EN 50121-3-2, EN 50121-4, -5
<b>Fire behavior: per EN 45545-2 hazard level HL3</b>	

WAGO is certified in accordance with the IRIS quality standard.



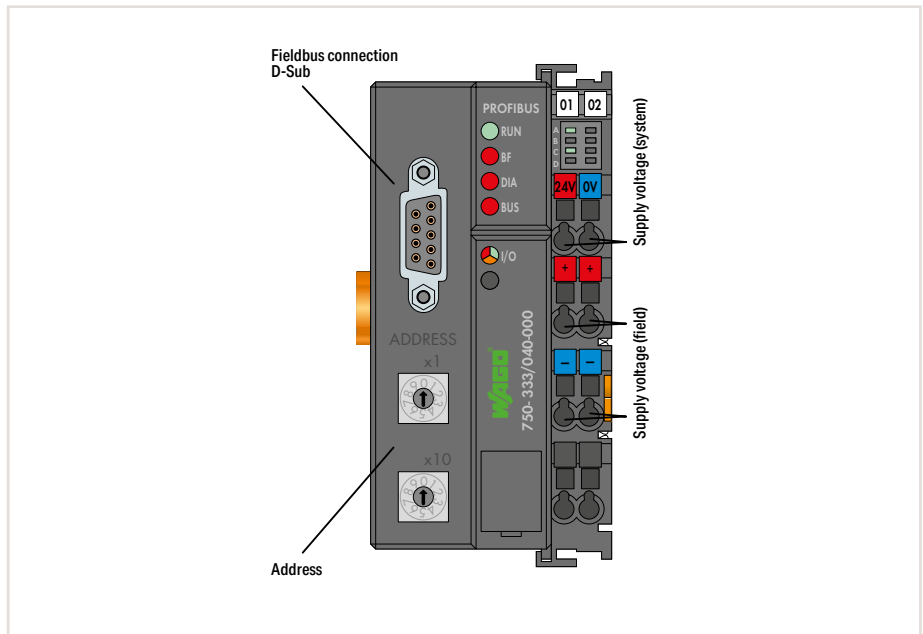
## I/O System – 750 XTR Series

### Standards and Rated Conditions

#### General Specifications

Supply voltage (system)	24 VDC (-25 ... +30 %); via power jumper contacts; Specified values for surrounding air temperature: +15 ... +35 °C For -40 ... +55 °C: 24 V (-25 ... +20 %); For +55 ... +70 °C: 24 V (-25 ... +10 %); Lower limit in all temperature ranges: -27.5 % (including 15 % residual ripple)
Supply voltage (system) for intrinsically safe XTR modules	24 VDC via power jumper contacts (Ex i power supply: $U_o = \text{max. } 26.8 \text{ V}$ )
Surrounding air temperature (operation)	-40 ... +70 °C
Surrounding air temperature (storage)	-40 ... +85 °C
Relative humidity	Max. 95 %; Short-term condensation per Class 3K7 / IEC EN 60721-3-3 and E DIN 40046-721-3 (except wind-driven precipitation, water and ice formation)
Operating altitude	Without temperature derating: 0 ... 2000 m; With temperature derating: 2000 ... 5000 m (0.5 K/100 m); max.: 5000 m
Pollution degree	2 per IEC 61131-2
Immunity to impulse voltages	Per EN 60870-2-1 Module ≤ 50 V: 510 VAC/775 VDC; Module > 50 V: 2.5 kVAC/3.5 kVDC Isolation: rated surge voltage (EN 60079-11) Module ≤ 50 V: 1 kV (Class VW1 per EN 60870-2-1) Module > 50 V: 5 kV (Class VW3 per EN 60870-2-1) Intrinsically safe module: 1 kV; 1.5 kV between intrinsically safe and non-intrinsically safe circuits Surge: Module ≤ 50 V: 1 kV (L - L) / 2 kV (L - E) Module > 50 V: 2 kV (L - L) / 4 kV (L - E)
Vibration resistance	<ul style="list-style-type: none"> <li>Per IEC 60068-2-6 (acceleration: 5g), EN 60870-2-2, IEC 60721-3-1, -3</li> <li>EN 50155; EN 61373 (not for intrinsically safe modules)</li> </ul>
Shock resistance	<ul style="list-style-type: none"> <li>Per IEC 60068-2-27 (15g/11 ms/half-sine/1,000 shocks; 25g/6 ms/1,000 shocks); EN 61373</li> <li>EN 50155 (not for intrinsically safe modules)</li> </ul>
EMC immunity to interference	<ul style="list-style-type: none"> <li>Per EN 61000-6-1, -2; EN 61131-2; Marine applications; EN 60255-26; EN 60870-2-1; EN 61850-3; IEC 61000-6-5; IEEE 1613; VDEW: 1994</li> <li>EN 50121-3-2; EN 50121-4, -5 (not for intrinsically safe modules)</li> </ul>
EMC emission of interference	<ul style="list-style-type: none"> <li>Per EN 61000-6-3, -4; EN 61131-2; EN 60255-26; Marine applications; EN 60870-2-1 (industrial and residential areas); EN 61850-3 (industrial and residential areas)</li> <li>EN 50121-3-2; EN 50121-4, -5 (not for intrinsically safe modules)</li> </ul>
Protection type	IP20
Mounting position	Horizontal (standing/lying) or vertical
Mounting type	DIN-35 rail mounting
Housing material	Polycarbonate; polyamid 6.6
Exposure to pollutants	Per IEC 60068-2-42 and IEC 60068-2-43
Permissible SO <sub>2</sub> contaminant concentration at a relative humidity < 75 %	25 ppm
Permissible H <sub>2</sub> S contaminant concentration at a relative humidity < 75 %	10 ppm
Connection technology	CAGE CLAMP®
Conductor cross section; strip length for standard modules and fieldbus couplers: Eco fieldbus couplers and power supply module:	0.25 ... 2.5 mm <sup>2</sup> /24 ... 14 AWG; 8 ... 9 mm/0.31 ... 0.35 inch 0.25 ... 1.5 mm <sup>2</sup> /24 ... 14 AWG; 5 ... 6 mm/0.2 ... 0.24 inch
Connection technology	Push-in CAGE CLAMP® (for I/O modules with 16 connection points)
Conductor cross section; strip length for I/O modules with 16 connection points:	0.25 ... 1.5 mm <sup>2</sup> /24 ... 16 AWG; 8 ... 9 mm/0.31 ... 0.35 inch
Current carrying capacity (power jumper contacts)	10 A; 1 A for all intrinsically safe modules

# Fieldbus Coupler PROFIBUS DP



<b>Item Description</b>	<b>Fieldbus Coupler PROFIBUS DP; 2nd generation; 12 MBd</b>
<b>Version</b>	<b>Extreme</b>
<b>Item no.</b>	<b>750-333/040-000</b>
<b>Order text</b>	FC PROFIBUS; G2; 12 MBd; XTR

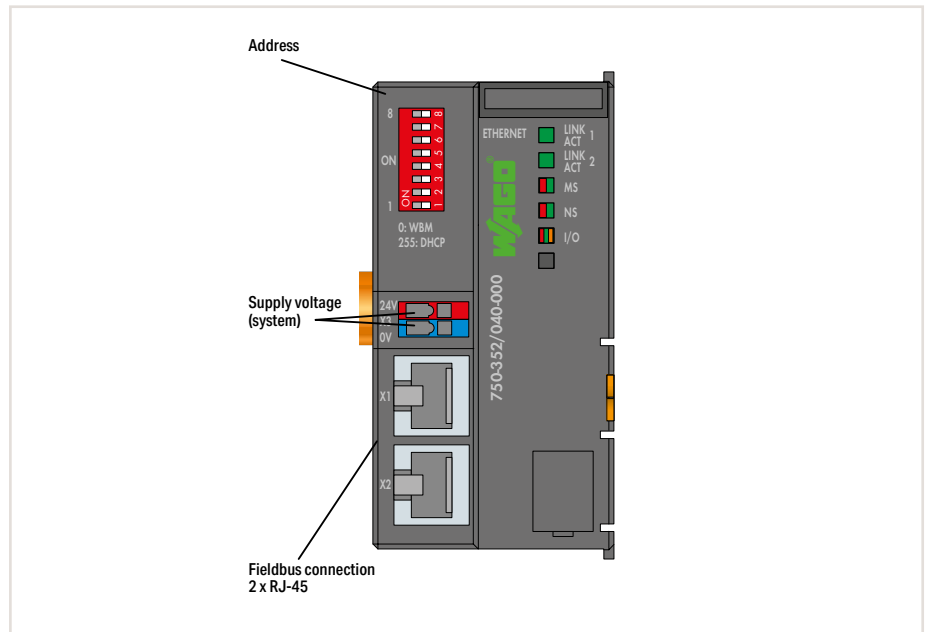
Technical Data	
Fieldbus	PROFIBUS
Protocols	PROFIBUS DP/V1
Connection technology: Fieldbus input/output	Socket D-Sub 9
Number of fieldbus nodes on master (max.)	96 with repeater
Baud rate	9.6 kBd ... 12 MBd
Transmission medium	Copper cable per EN 50170
Number of modules per node (max.)	63
Input and output process image (internal) max.	244 bytes
Supply voltage (system)	24 VDC (-25 ... +30 %); via wiring level (CAGE CLAMP® connection); Specified values for surrounding air temperature: +15 ... +35 °C; For -40 ... +55 °C: 24 V (-25 ... +20 %); For +55 ... +70 °C: 24 V (-25 ... +10 %); Lower limit in all temperature ranges: -27.5 % (including 15 % residual ripple)
Input current (typ.) at nominal load (24 V)	500 mA
Current consumption – system supply (5 V)	200 mA
Total current (system supply)	1800 mA
Rated surge voltage	1 kV
Surrounding air temperature (operation)	-40 ... +70 °C
Dimensions W x H x D	50.5 x 71.1 x 100 mm
<b>Approvals</b>	CE; Marine; OrdLoc/HazLoc; ATEX/IECEX
<b>Data sheet and further information, see:</b>	<a href="http://wago.com/750-333/040-000">wago.com/750-333/040-000</a>

<b>Accessories</b>	<b>Item no.</b>
GSD files	Download: <a href="http://www.wago.com">www.wago.com</a>

6

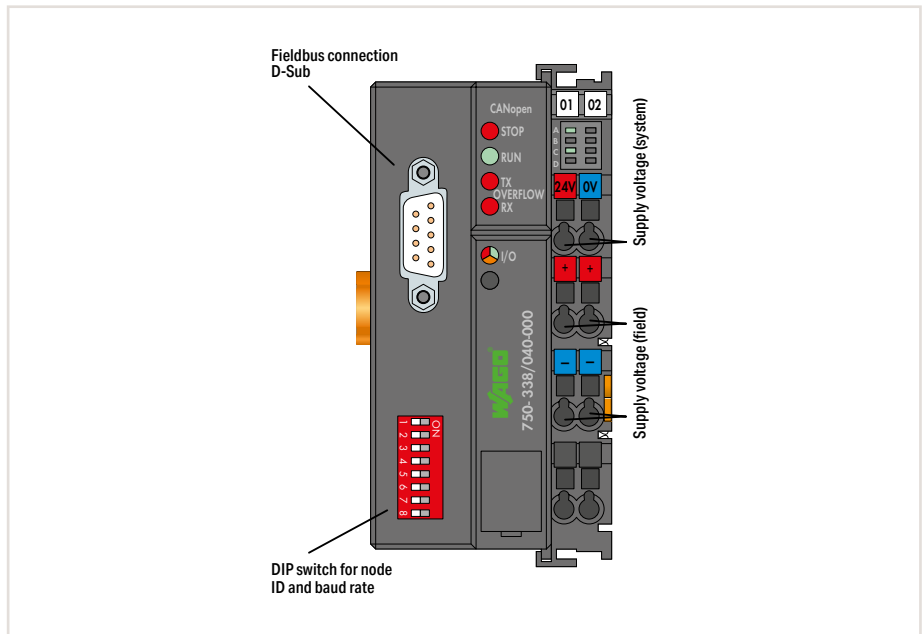
- „ Mini-WSB Quick Marking System, see Full Line Catalog, Volume 6
- „ DIN-rails and tools, see Section 10
- „ Approvals and corresponding ratings, see page 526 or [www.wago.com](http://www.wago.com)

## Fieldbus Coupler ETHERNET



<b>Item Description</b>	<b>Fieldbus Coupler ETHERNET; 3rd generation</b>
<b>Version</b>	<b>Extreme</b>
<b>Item no.</b>	<b>750-352/040-000</b>
<b>Order text</b>	<b>FC ETHERNET; G3; XTR</b>
<b>Technical Data</b>	
Fieldbus	EtherNet/IP; Modbus (TCP, UDP)
Protocols	HTTP; BootP; DHCP; DNS; FTP; SNMP
Connection technology: Fieldbus input/output	2 x RJ-45
Baud rate	10/100 Mbit/s
Transmission medium	Twisted Pair S-UTP; 100 Ω; Cat. 5
Number of modules per node (max.)	64
Input and output process image (internal) max.	1020 words
Supply voltage (system)	24 VDC (-25 ... 30 %); via wiring level (CAGE CLAMP® connection); Lower limit: -27.5 % (including 15 % residual ripple)
Input current (typ.) at nominal load (24 V)	280 mA
Current consumption – system supply (5 V)	450 mA
Total current (system supply)	700 mA
Rated surge voltage	1 kV
Surrounding air temperature (operation)	-40 ... +70 °C
Dimensions W x H x D	49.5 x 71.9 x 96.8 mm
<b>Approvals</b>	CE; Marine; OrdLoc/HazLoc; ATEX/IECEx
<b>Data sheet and further information, see:</b>	<a href="http://wago.com/750-352/040-000">wago.com/750-352/040-000</a>

# Fieldbus Coupler CANopen



<b>Item Description</b>	<b>Fieldbus Coupler CANopen; D-Sub</b>
<b>Version</b>	<b>Extreme</b>
<b>Item no.</b>	<b>750-338/040-000</b>
<b>Order text</b>	FC CANopen; DSub; XTR

Technical Data	
Fieldbus	CANopen
Connection technology: Fieldbus input/output	Plug D-Sub 9
Number of fieldbus nodes on master (max.)	110
Bus segment length (max.)	30 m ... 1000 m (depending on baud rate/cable)
Baud rate	10 kBd ... 1 MBd
Transmission medium	Shielded Cu cable 3 x 0.25 mm <sup>2</sup>
Number of modules per node (max.)	64
Input and output process image (internal) max.	512 bytes
Number of PDOs	32 Tx / 32 Rx
Number of SDOs	2 SDO servers
Communication profile	DS-301 V4.01
Device profile	DS-401 V2.0, Additional functions: limit monitoring; flank-triggered PDOs; configurable response in the event of an error

Supply voltage (system)	24 VDC (-25 ... +30 %); via wiring level (CAGE CLAMP® connection); Specified values for surrounding air temperature: +15 ... +35 °C; For -40 ... +55 °C: 24 V (-25 ... +20 %); For +55 ... +70 °C: 24 V (-25 ... +10 %); Lower limit in all temperature ranges: -27.5 % (including 15 % residual ripple )
Input current (typ.) at nominal load (24 V)	500 mA
Current consumption – system supply (5 V)	350 mA
Total current (system supply)	1650 mA
Rated surge voltage	1 kV
Surrounding air temperature (operation)	-40 ... +70 °C
Dimensions W x H x D	50.5 x 71.1 x 100 mm
Approvals	CE, IEC, Marine, OrdLoc/HazLoc, ATEX/IECEX
Data sheet and further information, see:	<a href="http://wago.com/750-338/040-000">wago.com/750-338/040-000</a>

<b>Accessories</b>	<b>Item no.</b>
EDS files	Download: <a href="http://www.wago.com">www.wago.com</a>

„ Mini-WSB marker card and mounting accessories, see Section "Accessories and Tools"  
 „ Approvals and corresponding ratings, see page 526 or [www.wago.com](http://www.wago.com)

6

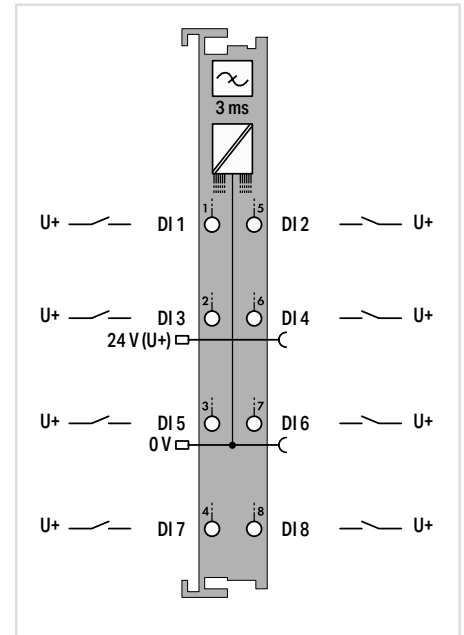
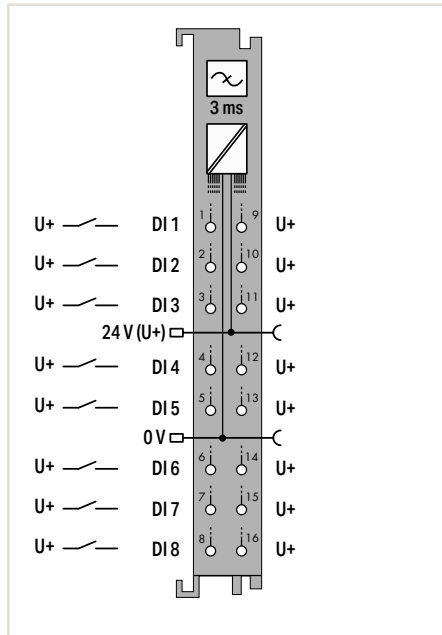
## Digital Input; 24 VDC



Figure: 750-1415/040-000

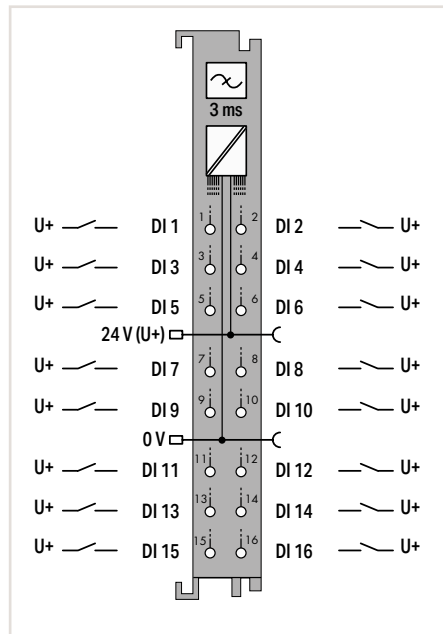


Figure: 750-430/040-000



Item Description	8-Channel Digital Input; 24 VDC; 3 ms; 2-wire connection	8-Channel Digital Input; 24 VDC; 3 ms
Version	Extreme	Extreme
Item no.	750-1415/040-000	750-430/040-000
Order text	8DI; 24 VDC; 3ms; 2-wire; XTR	8DI; 24 VDC; 3ms; XTR
<b>Technical Data</b>		
Number of digital inputs	8	8
Signal type	24 VDC	24 VDC
Voltage range for signal (0)	-3 ... +5 VDC	-3 ... +5 VDC
Voltage range for signal (1)	11 ... 30 VDC	15 ... 30 VDC
Sensor connection	2-wire	1-wire
Input characteristic	High-side switching	High-side switching
Input filter (digital)	3 ms	3 ms
Input current per channel for signal (1) typ.	4.5 mA	2.8 mA
Supply voltage (sensor)	24 VDC	24 VDC
Supply voltage (field)	24 VDC (-25 ... 30 %); via power jumper contacts (power supply via blade contact; transmission via spring contact); Specified values for surrounding air temperature: +15 ... +35 °C; for -40 ... +55 °C: 24 V (-25 ... +20 %); for +55 ... +70 °C: 24 V (-25 ... +10 %); Lower limit in all temperature ranges: -27.5 % (including 15 % residual ripple)	24 VDC (-25 ... 30 %); via power jumper contacts (power supply via blade contact; transmission via spring contact); Specified values for surrounding air temperature: +15 ... +35 °C; for -40 ... +55 °C: 24 V (-25 ... +20 %); for +55 ... +70 °C: 24 V (-25 ... +10 %); Lower limit in all temperature ranges: -27.5 % (including 15 % residual ripple)
Current consumption – system supply (5 V)	6 mA	17 mA
Rated surge voltage	1 kV	1 kV
Data width (internal)	8 bits	8 bits
Surrounding air temperature (operation)	-40 ... +70 °C	-40 ... +70 °C
Dimensions W x H x D	12 x 69 x 100 mm	12 x 67.8 x 100 mm
Approvals	CE; Marine; OrdLoc/HazLoc; ATEX/IECEX	CE; Marine; OrdLoc/HazLoc; ATEX/IECEX
Data sheet and further information, see:	<a href="http://wago.com/750-1415/040-000">wago.com/750-1415/040-000</a>	<a href="http://wago.com/750-430/040-000">wago.com/750-430/040-000</a>

## Digital Input; 24 VDC



<b>Item Description</b>	<b>16-Channel Digital Input; 24 VDC; 3 ms</b>
<b>Version</b>	<b>Extreme</b>
<b>Item no.</b>	<b>750-1405/040-000</b>
<b>Order text</b>	<b>16DI; 24 VDC; 3ms; XTR</b>
<b>Technical Data</b>	
Number of digital inputs	16
Signal type	24 VDC
Voltage range for signal (0)	-3 ... +5 VDC
Voltage range for signal (1)	11 ... 30 VDC
Sensor connection	1-wire
Input characteristic	High-side switching
Input filter (digital)	3 ms
Input current per channel for signal (1) typ.	2.3 mA
Supply voltage (field)	24 VDC (-25 ... 30 %); via power jumper contacts (power supply via blade contact; transmission via spring contact); Specified values for surrounding air temperature: +15 ... +35 °C; for -40 ... +55 °C: 24 V (-25 ... +20 %); for +55 ... +70 °C: 24 V (-25 ... +10 %); Lower limit in all temperature ranges: -27.5 % (including 15 % residual ripple)
Current consumption – system supply (5 V)	25 mA
Rated surge voltage	1 kV
Data width (internal)	16 bits
Surrounding air temperature (operation)	-40 ... +70 °C
Dimensions W x H x D	12 x 69 x 100 mm
<b>Approvals</b>	CE;  Marine;  OrdLoc/HazLoc; ATEX/IECEX
<b>Data sheet and further information, see:</b>	<a href="http://wago.com/750-1405/040-000">wago.com/750-1405/040-000</a>

„ Mini-WSB marker card and mounting accessories, see Section “Accessories and Tools”

„ Approvals and corresponding ratings, see page 526 or [www.wago.com](http://www.wago.com)

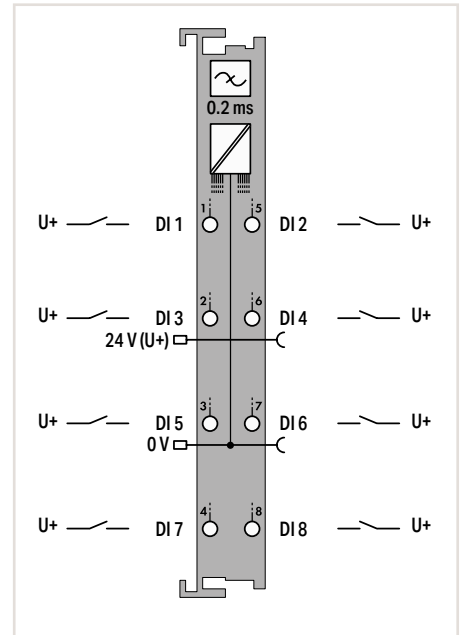
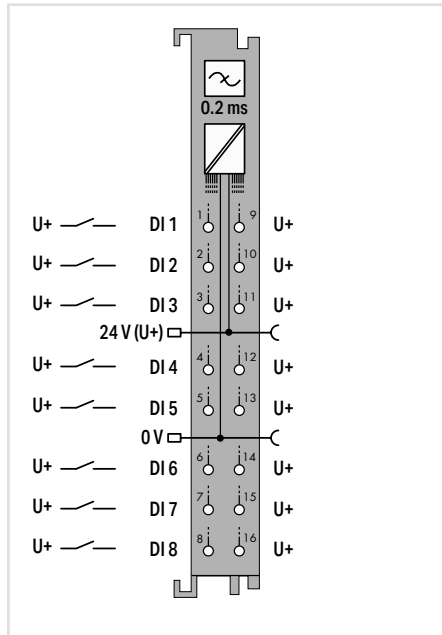
## Digital Input; 24 VDC



Figure: 750-1416/040-000

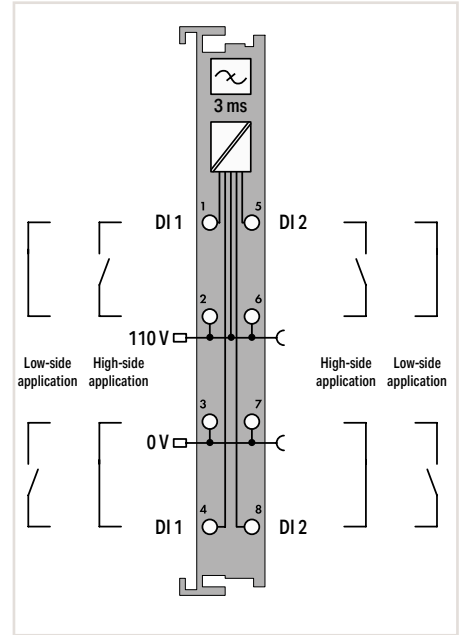
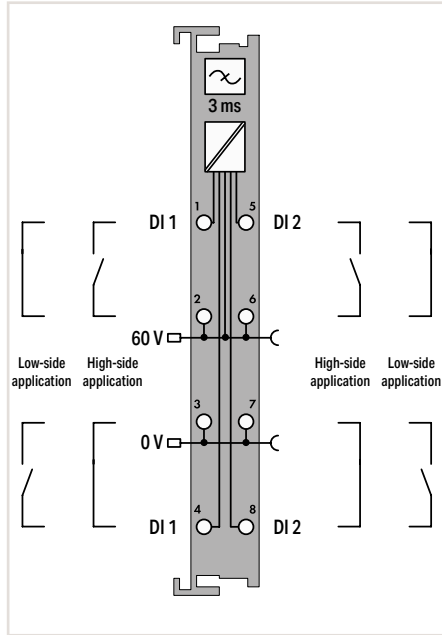


Figure: 750-431/040-000



Item Description	8-Channel Digital Input; 24 VDC; 0.2 ms; 2-wire connection	8-Channel Digital Input; 24 VDC; 0.2 ms
Version	Extreme	Extreme
Item no.	750-1416/040-000	750-431/040-000
Order text	8DI; 24 VDC; 0.2ms; 2-wire; XTR	8DI; 24 VDC; 0.2ms; XTR
<b>Technical Data</b>		
Number of digital inputs	8	8
Signal type	24 VDC	24 VDC
Voltage range for signal (0)	-3 ... +5 VDC	-3 ... +5 VDC
Voltage range for signal (1)	11 ... 30 VDC	15 ... 30 VDC
Sensor connection	2-wire	1-wire
Input characteristic	High-side switching	High-side switching
Input filter (digital)	0.2 ms	0.2 ms
Input current per channel for signal (1) typ.	4.5 mA	2.8 mA
Supply voltage (sensor)	24 VDC	24 VDC
Supply voltage (field)	24 VDC (-25 ... 30 %); via power jumper contacts (power supply via blade contact; transmission via spring contact); Specified values for surrounding air temperature: +15 ... +35 °C; for -40 ... +55 °C: 24 V (-25 ... +20 %); for +55 ... +70 °C: 24 V (-25 ... +10 %); Lower limit in all temperature ranges: -27.5 % (including 15 % residual ripple)	24 VDC (-25 ... 30 %); via power jumper contacts (power supply via blade contact; transmission via spring contact); Specified values for surrounding air temperature: +15 ... +35 °C; for -40 ... +55 °C: 24 V (-25 ... +20 %); for +55 ... +70 °C: 24 V (-25 ... +10 %); Lower limit in all temperature ranges: -27.5 % (including 15 % residual ripple)
Current consumption – system supply (5 V)	6 mA	17 mA
Rated surge voltage	1 kV	1 kV
Data width (internal)	8 bits	8 bits
Surrounding air temperature (operation)	-40 ... +70 °C	-40 ... +70 °C
Dimensions W x H x D	12 x 69 x 100 mm	12 x 67.8 x 100 mm
Approvals	CE; Marine; OrdLoc/HazLoc; ATEX/IECEX	CE; Marine; OrdLoc/HazLoc; ATEX/IECEX
Data sheet and further information, see:	<a href="http://wago.com/750-1416/040-000">wago.com/750-1416/040-000</a>	<a href="http://wago.com/750-431/040-000">wago.com/750-431/040-000</a>

## Digital Input; 60 VDC; 110 VDC or 220 VDC



Item Description	2-Channel Digital Input; 60 VDC; 3 ms	2-Channel Digital Input; 110 VDC
Version	Extreme	Extreme
Item no.	750-429/040-001	750-427/040-000
Order text	2DI; 60 VDC; 3ms; XTR	2DI; 110 VDC; XTR
<b>Technical Data</b>		
Number of digital inputs	2	2
Signal type	60 VDC	110 VDC
Voltage range for signal (0)	-7.5 ... +12 VDC	-14 ... +50 VDC
Voltage range for signal (1)	44 ... 78 VDC	70 ... 143 VDC
Sensor connection	2-wire	2-wire
Input characteristic	High-side/low-side switching; configurable	High-side/low-side switching; configurable
Input filter (digital)	3 ms	3 ms
Input current per channel for signal (1) typ.	2.9 mA	2.5 mA
Supply voltage (sensor)	60 VDC	110 VDC
Supply voltage (field)	60 VDC (-25 ... +30 %); via power jumper contacts (power supply via blade contact; transmission via spring contact)	110 VDC (-25 ... +30 %); via power jumper contacts (power supply via blade contact; transmission via spring contact)
Current consumption – system supply (5 V)	2.5 mA	2.5 mA
Rated surge voltage	5.0 kV (EN 60870-2-1 / Class VW3); 2.5 kV (UL 508); 2.5 kV (EN 60664-1 / to 5,000 m ASL)	5.0 kV (EN 60870-2-1 / Class VW3); 4.0 kV (UL 508); 4.0 kV (EN 60664-1 / to 2,000 m ASL); 2.5 kV (EN 60664-1 / > 2,000 m to 5,000 m ASL)
Overvoltage category	Nominal voltage 60 V: IV (EN 60664-1 / to 5,000 m ASL)	Nominal voltage 110 V: IV (EN 60664-1 / to 2,000 m ASL); III (EN 60664-1 / > 2,000 m to 5,000 m ASL)
Data width (internal)	2 bits	2 bits
Surrounding air temperature (operation)	-40 ... +70 °C	-40 ... +70 °C
Dimensions W x H x D	12 x 67.8 x 100 mm	12 x 67.8 x 100 mm
Approvals	CE; Marine; OrdLoc/HazLoc; ATEX/IECEx	CE; Marine; OrdLoc/HazLoc; ATEX/IECEx
Data sheet and further information, see:	<a href="http://wago.com/750-429/040-001">wago.com/750-429/040-001</a>	<a href="http://wago.com/750-427/040-000">wago.com/750-427/040-000</a>

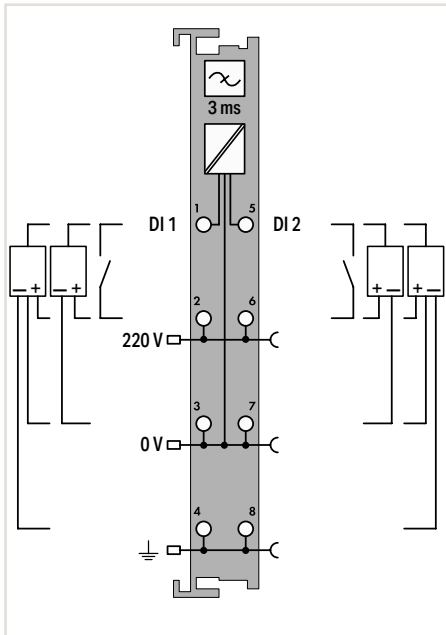
Notice:  
An additional supply module must be added for operation with 60 VDC!

Notice:  
An additional supply module must be added for operation with 110 VDC!

6

„ Mini-WSB marker card and mounting accessories, see Section "Accessories and Tools"  
„ Approvals and corresponding ratings, see page 526 or [www.wago.com](http://www.wago.com)



**2-Channel Digital Input; 220 VDC****Extreme**

750-407/040-000

2DI; 220 VDC; XTR

2

220 VDC

-3 ... +100 VDC

160 ... 286 VDC

2-wire; 3-wire; 4-wire

High-side switching

3 ms

1.2 mA

220 VDC

220 VDC (-25 ... +25 %); via power jumper contacts (power supply via blade contact; transmission via spring contact)

5 mA

5.0 kV (EN 60870-2-1 / Class VW3);

4.0 kV (UL 508);

4.0 kV (EN 60664-1 / to 4,000 m ASL);

2.5 kV (EN 60664-1 / &gt; 4,000 m to 5,000 m ASL)

Nominal voltage 220 V:

III (EN 60664-1 / to 4,000 m ASL);

II (EN 60664-1 / &gt; 4,000 m to 5,000 m ASL)

2 bits

-40 ... +70 °C

12 x 67.8 x 100 mm

CE; Marine; OrdLoc/HazLoc;  
ATEX/IECEx

[wago.com/750-407/040-000](http://wago.com/750-407/040-000)

**Notice:**

An additional supply module must be added for operation with 220 VDC!

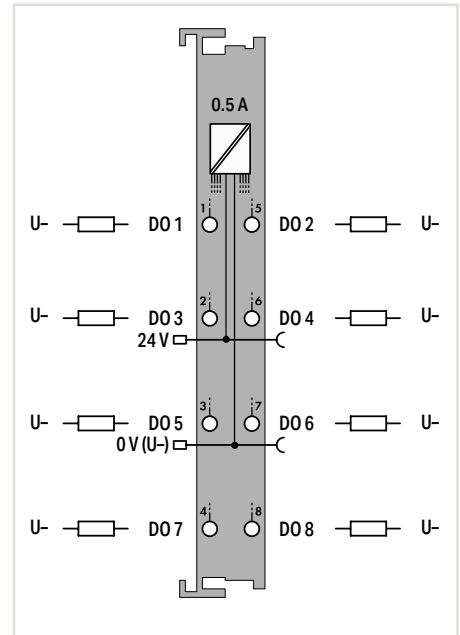
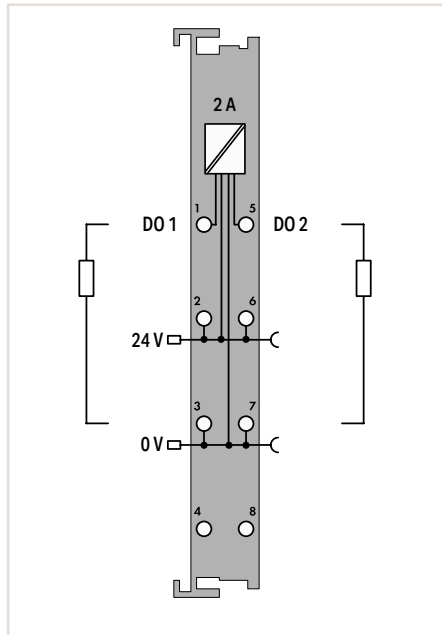
## Digital Output; 24 VDC



Figure: 750-508/040-000



Figure: 750-537/040-000

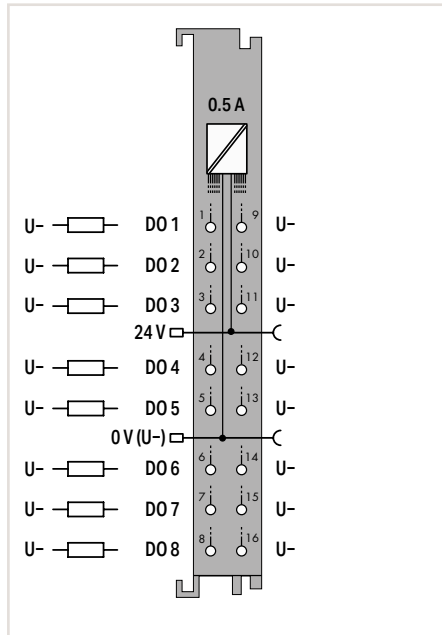


Item Description	2-Channel Digital Output; 24 VDC; 2 A; Diagnostics	8-Channel Digital Output; 24 VDC; 0.5 A; Diagnostics
Version	Extreme	Extreme
Item no.	750-508/040-000	750-537/040-000
Order text	2DO; 24 VDC; 2A; Diagn; XTR	8DO; 24 VDC; 0.5A; Diagn; XTR
<b>Technical Data</b>		
Number of digital outputs	2	8
Signal type	24 VDC	24 VDC
Output characteristic	High-side switching	High-side switching
Output current per channel	2 A; short-circuit-protected	0.5 A; short-circuit-protected
Load type	Resistive; inductive; lamp load	Resistive; inductive; lamp load
Actuator connection	2-wire; 3-wire	1-wire
Switching frequency (max.)	1 kHz	1 kHz
Diagnostics	Open circuit; overload; short circuit	Open circuit; overload; short circuit
Supply voltage (field)	24 VDC (-25 ... 30 %); via power jumper contacts (power supply via blade contact; transmission via spring contact); Specified values for surrounding air temperature: +15 ... +35 °C; for -40 ... +55 °C: 24 V (-25 ... +20 %); for +55 ... +70 °C: 24 V (-25 ... +10 %); Lower limit in all temperature ranges: -27.5 % (including 15 % residual ripple)	24 VDC (-25 ... 30 %); via power jumper contacts (power supply via blade contact; transmission via spring contact); Specified values for surrounding air temperature: +15 ... +35 °C; for -40 ... +55 °C: 24 V (-25 ... +20 %); for +55 ... +70 °C: 24 V (-25 ... +10 %); Lower limit in all temperature ranges: -27.5 % (including 15 % residual ripple)
Current consumption – system supply (5 V)	14 mA	50 mA
Rated surge voltage	1 kV	1 kV
Data width (internal)	2-bit input; 2-bit output	8-bit input; 8-bit output
Surrounding air temperature (operation)	-40 ... +70 °C	-40 ... +70 °C
Dimensions W x H x D	12 x 67.8 x 100 mm	12 x 67.8 x 100 mm
Approvals	CE; Marine; OrdLoc/HazLoc; ATEX/IECEx	CE; Marine; OrdLoc/HazLoc; ATEX/IECEx
Data sheet and further information, see:	<a href="http://wago.com/750-508/040-000">wago.com/750-508/040-000</a>	<a href="http://wago.com/750-537/040-000">wago.com/750-537/040-000</a>

6

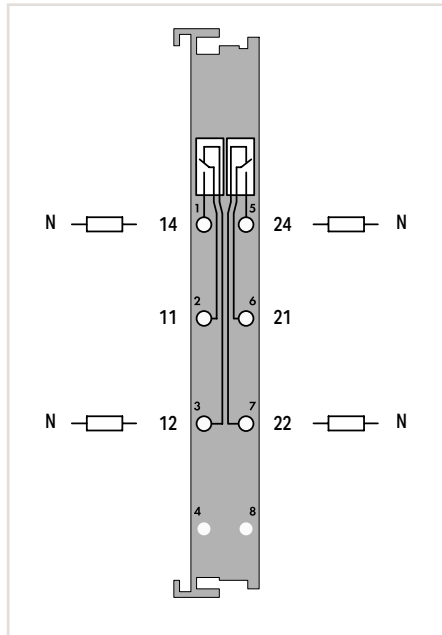
„ Mini-WSB marker card and mounting accessories, see Section “Accessories and Tools”  
 „ Approvals and corresponding ratings, see page 526 or www.wago.com

# Digital Output; 24 VDC



<b>Item Description</b>	<b>8-Channel Digital Output; 24 VDC; 0.5 A; 2-wire connection</b>
<b>Version</b>	<b>Extreme</b>
<b>Item no.</b>	<b>750-1515/040-000</b>
<b>Order text</b>	<b>8DO; 24 VDC; 0.5A; 2-wire; XTR</b>
<b>Technical Data</b>	
Number of digital outputs	8
Signal type	24 VDC
Output characteristic	High-side switching
Output current per channel	0.5 A; short-circuit-protected
Load type	Resistive; inductive; lamp load
Actuator connection	2-wire
Switching frequency (max.)	1 kHz
Diagnostics	Open circuit; overload; short circuit
Supply voltage (field)	24 VDC (-25 ... 30 %); via power jumper contacts (power supply via blade contact; transmission via spring contact); Specified values for surrounding air temperature: +15 ... +35 °C; for -40 ... +55 °C: 24 V (-25 ... +20 %); for +55 ... +70 °C: 24 V (-25 ... +10 %); Lower limit in all temperature ranges: -27.5 % (including 15 % residual ripple)
Current consumption – system supply (5 V)	20 mA
Rated surge voltage	1 kV
Data width (internal)	8 bits
Surrounding air temperature (operation)	-40 ... +70 °C
Dimensions W x H x D	12 x 69 x 100 mm
<b>Approvals</b>	CE; Marine; OrdLoc/HazLoc; ATEX/IECEX
<b>Data sheet and further information, see:</b>	<a href="http://wago.com/750-1515/040-000">wago.com/750-1515/040-000</a>

## Relay Output; 230 VAC

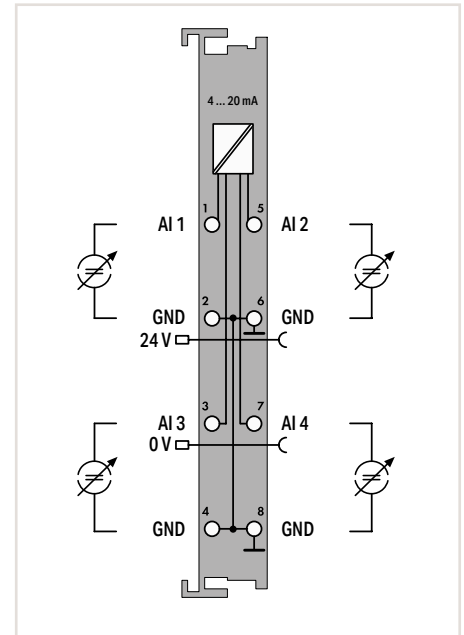
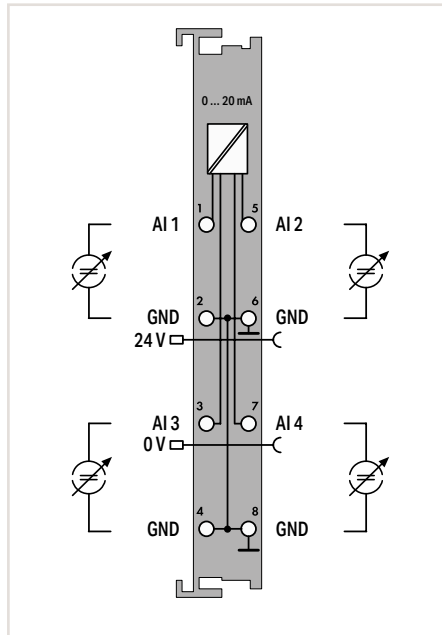


<b>Item Description</b>	<b>2-Channel Relay Output; 250 VAC; 1 A; Relay with 2 changeover contacts</b>
<b>Version</b>	<b>Extreme</b>
<b>Item no.</b>	<b>750-517/040-000</b>
<b>Order text</b>	2RO; 250 VAC; 1A; Relay2CO; XTR
<b>Technical Data</b>	
Number of digital outputs	2
Switching voltage (max.)	250 VAC; 300 VDC
Output circuit design	2 changeover contacts; relay
Output characteristic	Potential-free
Switching current (max.)	1 A at 250 VAC / 40 VDC; 0.15 A at 300 VDC
Switching current (min.)	100 mA (12 VDC)
Actuator connection	1-wire
Switching frequency (max.)	0.1 Hz
Mechanical switching operations (min.)	5 x 10 <sup>6</sup>
Electrical switching operations (min.)	10 x 10 <sup>5</sup>
Current consumption – system supply (5 V)	90 mA
Rated surge voltage	5.0 kV (EN 60870-2-1 / Class VW3); 6.0 kV (UL 508); 6.0 kV (EN 60664-1 / to 4,000 m ASL); 4.0 kV (EN 60664-1 / > 4,000 m to 5,000 m ASL)
Overvoltage category	Nominal voltage 230 V: IV (EN 60664-1 / to 4,000 m ASL); III (EN 60664-1 / > 4,000 m to 5,000 m ASL)
Data width (internal)	2 bits
Surrounding air temperature (operation)	-40 ... +70 °C
Dimensions W x H x D	12 x 67.8 x 100 mm
<b>Approvals</b>	CE; Marine; OrdLoc/HazLoc; ATEX/IECEX
<b>Data sheet and further information, see:</b>	<a href="http://wago.com/750-517/040-000">wago.com/750-517/040-000</a>

„ Mini-WSB marker card and mounting accessories, see Section “Accessories and Tools”

„ Approvals and corresponding ratings, see page 526 or [www.wago.com](http://www.wago.com)

## Analog Input; 0 ... 20 mA or 4 ... 20 mA



<b>Item Description</b>
<b>Version</b>
<b>Item no.</b>
<b>Order text</b>

<b>4-Channel Analog Input; 0 ... 20 mA; single-ended</b>
<b>Extreme</b>
<b>750-453/040-000</b>
<b>4AI; 0-20mA; SE; XTR</b>

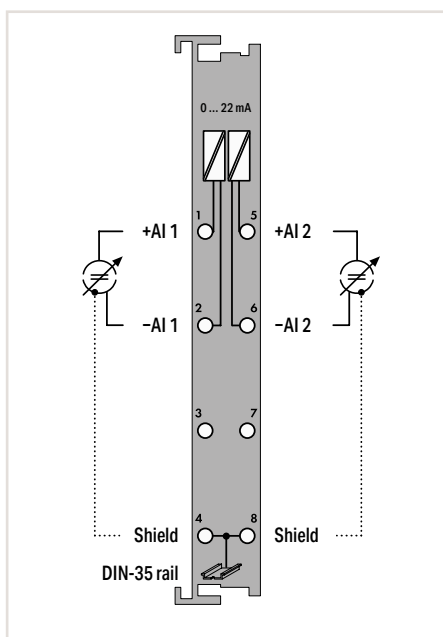
<b>4-Channel Analog Input; 4 ... 20 mA; single-ended</b>
<b>Extreme</b>
<b>750-455/040-000</b>
<b>4AI; 4-20mA; SE; XTR</b>

Technical Data	
Number of analog inputs	4
Signal type	0 ... 20 mA
Signal characteristic	Single-ended
Resolution	12 bits
Conversion time	10 ms
Input resistance	< 100 Ω / 20 mA
Measuring error max., 25 °C	±0.1 % of the upper-range value
Temperature error max.	±0.01 % / K of the upper-range value
Supply voltage (field)	24 VDC (-25 ... 30 %); via power jumper contacts (power supply via blade contact; transmission via spring contact); Specified values for surrounding air temperature: +15 ... +35 °C; for -40 ... +55 °C: 24 V (-25 ... +20 %); for +55 ... +70 °C: 24 V (-25 ... +10 %); Lower limit in all temperature ranges: -27.5 % (including 15 % residual ripple)
Current consumption – system supply (5 V)	65 mA
Rated surge voltage	1 kV
Data width	4 x 16-bit data; 4 x 8-bit control/status (optional)
Surrounding air temperature (operation)	-40 ... +70 °C
Dimensions W x H x D	12 x 67.8 x 100 mm
<b>Approvals</b>	CE; Marine; OrdLoc/HazLoc; ATEX/IECEx
<b>Data sheet and further information, see:</b>	<a href="http://wago.com/750-453/040-000">wago.com/750-453/040-000</a>

Number of analog inputs	4
Signal type	4 ... 20 mA
Signal characteristic	Single-ended
Resolution	12 bits
Conversion time	10 ms
Input resistance	< 100 Ω / 20 mA
Measuring error max., 25 °C	±0.1 % of the upper-range value
Temperature error max.	±0.01 % / K of the upper-range value
Supply voltage (field)	24 VDC (-25 ... 30 %); via power jumper contacts (power supply via blade contact; transmission via spring contact); Specified values for surrounding air temperature: +15 ... +35 °C; for -40 ... +55 °C: 24 V (-25 ... +20 %); for +55 ... +70 °C: 24 V (-25 ... +10 %); Lower limit in all temperature ranges: -27.5 % (including 15 % residual ripple)
Current consumption – system supply (5 V)	65 mA
Rated surge voltage	1 kV
Data width	4 x 16-bit data; 4 x 8-bit control/status (optional)
Surrounding air temperature (operation)	-40 ... +70 °C
Dimensions W x H x D	12 x 67.8 x 100 mm
<b>Approvals</b>	CE; Marine; OrdLoc/HazLoc; ATEX/IECEx
<b>Data sheet and further information, see:</b>	<a href="http://wago.com/750-455/040-000">wago.com/750-455/040-000</a>

Number of analog inputs	4
Signal type	4 ... 20 mA
Signal characteristic	Single-ended
Resolution	12 bits
Conversion time	10 ms
Input resistance	< 100 Ω / 20 mA
Measuring error max., 25 °C	±0.1 % of the upper-range value
Temperature error max.	±0.01 % / K of the upper-range value
Supply voltage (field)	24 VDC (-25 ... 30 %); via power jumper contacts (power supply via blade contact; transmission via spring contact); Specified values for surrounding air temperature: +15 ... +35 °C; for -40 ... +55 °C: 24 V (-25 ... +20 %); for +55 ... +70 °C: 24 V (-25 ... +10 %); Lower limit in all temperature ranges: -27.5 % (including 15 % residual ripple)
Current consumption – system supply (5 V)	65 mA
Rated surge voltage	1 kV
Data width	4 x 16-bit data; 4 x 8-bit control/status (optional)
Surrounding air temperature (operation)	-40 ... +70 °C
Dimensions W x H x D	12 x 67.8 x 100 mm
<b>Approvals</b>	CE; Marine; OrdLoc/HazLoc; ATEX/IECEx
<b>Data sheet and further information, see:</b>	<a href="http://wago.com/750-455/040-000">wago.com/750-455/040-000</a>

## Analog Input; 4 ... 20 mA

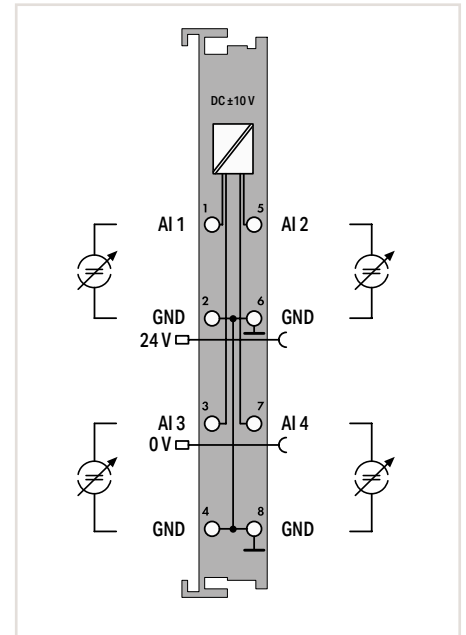
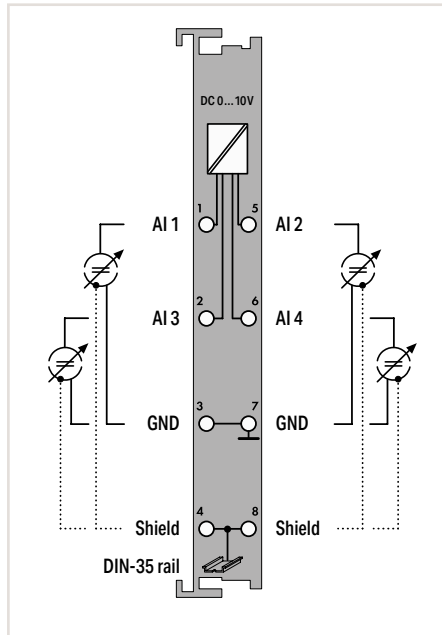


<b>Item Description</b>	2-Channel Analog Input; 4 ... 20 mA; Differential input; NE43
<b>Version</b>	Extreme
<b>Item no.</b>	750-492/040-001
<b>Order text</b>	2AI; 4-20mA; Diff; NE43; XTR
<b>Technical Data</b>	
Number of analog inputs	2
Signal type	3.8 ... 20.5 mA (NE43)
Signal characteristic	Differential
Resolution	13 bits
Conversion time	1 ms
Input resistance	< 270Ω / 20mA
Measuring error max., 25 °C	±0.1 % of the upper-range value
Temperature error max.	±0.01 % / K of the upper-range value
Current consumption – system supply (5 V)	80 mA
Rated surge voltage	1 kV
Data width	2 x 16-bit data; 2 x 8-bit control/status (optional)
Surrounding air temperature (operation)	-40 ... +70 °C
Dimensions W x H x D	12 x 67.8 x 100 mm
<b>Approvals</b>	CE; Marine; OrdLoc/HazLoc; ATEX/IECEX
<b>Data sheet and further information, see:</b>	<a href="http://wago.com/750-492/040-001">wago.com/750-492/040-001</a>

„ Mini-WSB marker card and mounting accessories, see Section “Accessories and Tools”

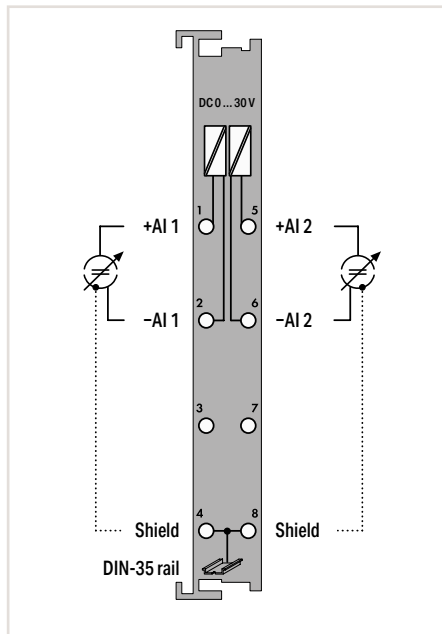
„ Approvals and corresponding ratings, see page 526 or [www.wago.com](http://www.wago.com)

## Analog Input; 0 ... 10 VDC or ±10 VDC



Item Description	4-Channel Analog Input; 0 ... 10 VDC; single-ended	4-Channel Analog Input; ±10 VDC; single-ended
Version	Extreme	Extreme
Item no.	750-468/040-000	750-457/040-000
Order text	4AI; 0-10 VDC; SE; XTR	4AI; ±10 VDC; SE; XTR
<b>Technical Data</b>		
Number of analog inputs	4	4
Signal type	0 ... 10 V	±10 V
Signal characteristic	Single-ended	Single-ended
Resolution	12 bits	12 bits
Conversion time	4 ms	10 ms
Input resistance	133 kΩ	> 100 kΩ
Input voltage (max.)	35 V	±40 V
Measuring error max., 25 °C	±0.2 % of the upper-range value	±0.1 % of the upper-range value
Temperature error max.	±0.01 % / K of the upper-range value	±0.01 % / K of the upper-range value
Supply voltage (field)		24 VDC (-25 ... 30 %); via power jumper contacts (power supply via blade contact; transmission via spring contact); Specified values for surrounding air temperature: +15 ... +35 °C; for -40 ... +55 °C: 24 V (-25 ... +20 %); for +55 ... +70 °C: 24 V (-25 ... +10 %); Lower limit in all temperature ranges: -27.5 % (including 15 % residual ripple)
Current consumption – system supply (5 V)	60 mA	65 mA
Rated surge voltage	1 kV	1 kV
Data width	4 x 16-bit data; 4 x 8-bit control/status (optional)	4 x 16-bit data; 4 x 8-bit control/status (optional)
Surrounding air temperature (operation)	-40 ... +70 °C	-40 ... +70 °C
Dimensions W x H x D	12 x 67.8 x 100 mm	12 x 67.8 x 100 mm
Approvals	CE; Marine; OrdLoc/HazLoc; ATEX/IECEx	CE; Marine; OrdLoc/HazLoc; ATEX/IECEx
Data sheet and further information, see:	wago.com/750-468/040-000	wago.com/750-457/040-000

## Analog Input; 0 ... 30 VDC



Item Description	2-Channel Analog Input; 0 ... 30 VDC; Differential input
Version	Extreme
Item no.	750-483/040-000
Order text	2AI; 0-30 VDC; Diff; XTR
<b>Technical Data</b>	
Extended functionality	Time-synchronized measured value acquisition within the module
Number of analog inputs	2
Signal type	0 ... 30 V
Signal characteristic	Differential
Resolution	14 bits
Conversion time	1 ms
Internal resistance	1 MΩ
Measuring error max., 25 °C	±0.1 % of the upper-range value
Temperature error max.	±0.01 % / K of the upper-range value
Current consumption – system supply (5 V)	80 mA
Data width	2 x 16-bit data; 2 x 8-bit control/status (optional)
Rated surge voltage	1 kV
Surrounding air temperature (operation)	-40 ... +70 °C
Dimensions W x H x D	12 x 67.8 x 100 mm
Approvals	CE; Marine; OrdLoc/HazLoc; ATEX/IECEX
Data sheet and further information, see:	<a href="http://wago.com/750-483/040-000">wago.com/750-483/040-000</a>

„ Mini-WSB marker card and mounting accessories, see Section “Accessories and Tools”

„ Approvals and corresponding ratings, see page 526 or [www.wago.com](http://www.wago.com)



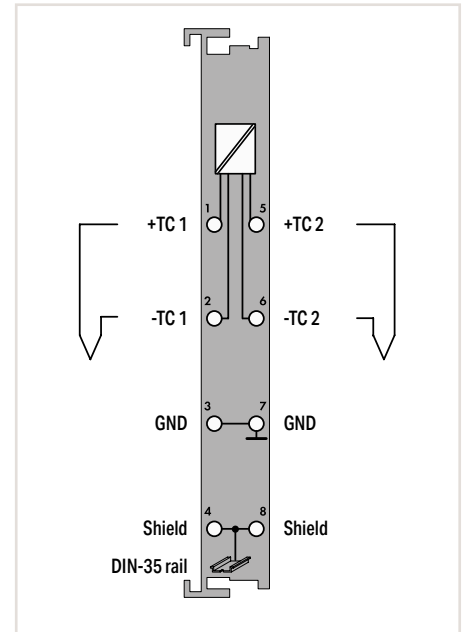
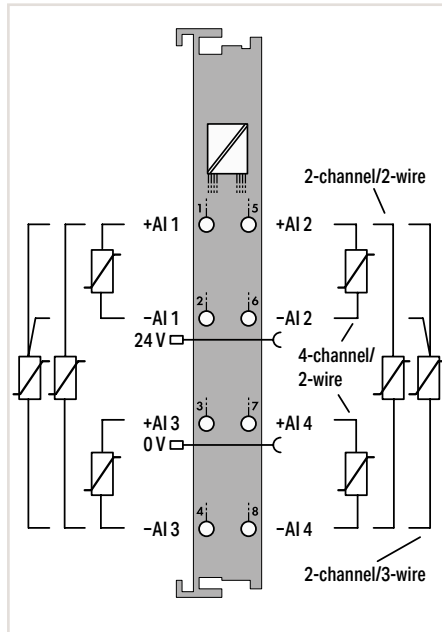
## Analog Input; for Resistance Sensors or Thermocouples



Figure: 750-464/040-000

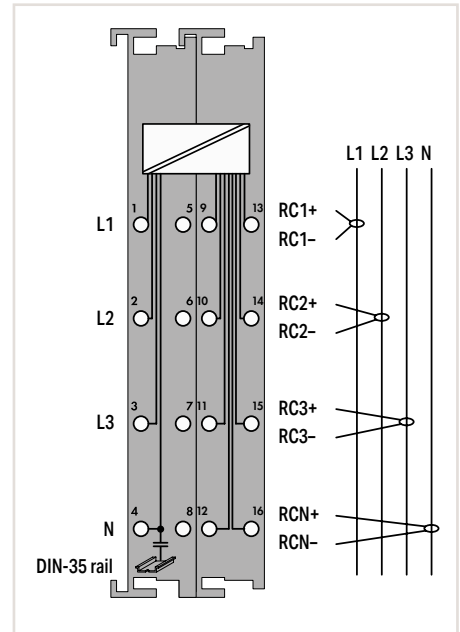
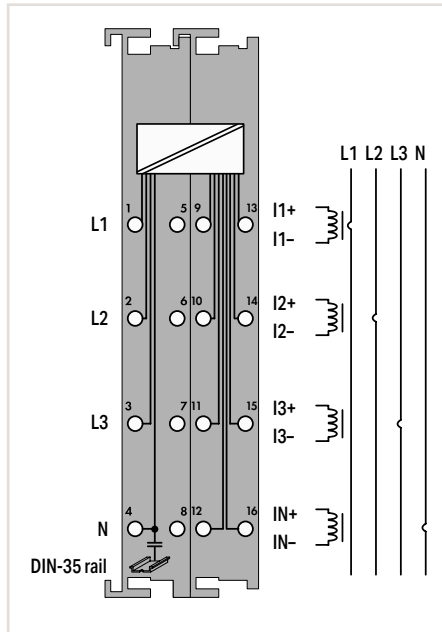


Figure: 750-469/040-000



Item Description	2/4-Channel Analog Input; Resistance measurement; adjustable	2-Channel Analog Input; Thermocouple; adjustable
Version	Extreme	Extreme
Item no.	750-464/040-000	750-469/040-000
Order text	2/4AI; RTD; Adjust; XTR	2AI; TC; Adjust; XTR
<b>Technical Data</b>		
Number of analog inputs	2/4	2
Signal type	Pt100; Configurable: Pt200; Pt500; Pt1000 (IEC 751); Ni100; Ni1000 (DIN 43760); Ni120 (Minco); Ni1000 (TK 5000); 2-channel operation: Potentiometer; Resistance measurement 10 ... 5000 Ω; 10 ... 1200 Ω	Type K; Configurable: J; E; S; T; L; N; U; B; R; -30 ... +30 mV; -60 ... +60 mV; -120 ... +120 mV
Sensor connection	2-wire; 3-wire	2-wire
Temperature range	-200 ... +850 °C (Pt100 ... Pt1000); -60 ... +300 °C (Ni100, Ni1000); -60 ... +250 °C (Ni1000 TK5000); -80 ... +260 °C (Ni120)	Sensor-specific
Resolution	0.1 °C	0.1 °C
Conversion time	320 ms	320 ms
Measured current (typ.)	≤ 350 µA per measurement circuit	
Measuring error max., 25 °C	1 K over entire temperature range; 0.5 K over limited temperature range (-30 °C ... +120 °C)	±6 K (voltage input ±2 K; cold junction compensation ±4 K)
Temperature error max.	20 ppm/K; typ. 5 ppm/K	±0.2 K/K
Cold junction compensation		Integrated or external
Supply voltage (field)	24 VDC (-25 ... 30 %); via power jumper contacts (power supply via blade contact; transmission via spring contact); Specified values for surrounding air temperature: +15 ... +35 °C; for -40 ... +55 °C: 24 V (-25 ... +20 %); for +55 ... +70 °C: 24 V (-25 ... +10 %); Lower limit in all temperature ranges: -27.5 % (including 15 % residual ripple)	
Current consumption – system supply (5 V)	50 mA	65 mA
Rated surge voltage	1 kV	1 kV
Data width	4 (2) x 16-bit data; 4 (2) x 8-bit control/status (optional)	2 x 16-bit data; 2 x 8-bit control/status (optional)
Surrounding air temperature (operation)	-40 ... +70 °C	-40 ... +70 °C
Dimensions W x H x D	12 x 67.8 x 100 mm	12 x 67.8 x 100 mm
Approvals	CE; Marine; OrdLoc/HazLoc; ATEX/IECEx	CE; Marine; OrdLoc/HazLoc; ATEX/IECEx
Data sheet and further information, see:	wago.com/750-464/040-000	wago.com/750-469/040-000

## Analog Input; for 3-Phase Power Measurement



<b>Item Description</b>
<b>Version</b>
<b>Item no.</b>
<b>Order text</b>

<b>3-Phase Power Measurement; 690 VAC 1 A</b>	
<b>Extreme</b>	<b>690 VAC 5 A; extreme</b>
<b>750-495/040-000</b>	<b>750-495/040-001</b>
<b>3-PHASE POM; 690VAC 1A; XTR</b>	<b>3-PHASE POM; 690VAC 5A; XTR</b>

<b>3-Phase Power Measurement;</b>	
<b>690 VAC Rogowski coils; extreme</b>	
<b>750-495/040-002</b>	
<b>3-PHASE POM; 690VAC R.C.; XTR</b>	

**Technical Data**

<b>Signal type</b>
Measured variables

<b>3-phase power measurement</b>
Voltage; current; effective power; reactive power; apparent power; power consumption; frequency; cos phi; harmonics (up to the 41st harmonic); THD; current measurement in N-conductor; and more

<b>3-phase power measurement</b>
Voltage; current; effective power; reactive power; apparent power; power consumption; frequency; cos phi; harmonics (up to the 41st harmonic); THD; current measurement in N-conductor; and more

<b>Number of measurement inputs</b>
-------------------------------------

7 (3 voltage measurement inputs; 4 differential current measurement inputs)
---

7 (3 voltage measurement inputs; 4 differential current measurement inputs)
---

<b>Rated voltage</b>
----------------------

$U_{LN} = 400 \text{ VAC/DC}; U_{LL} = 690 \text{ VAC}$
---

$U_{LN} = 277 \text{ VAC/DC}; U_{LL} = 480 \text{ VAC}$
---

<b>Input resistance (voltage path) typ.</b>
---

1429 kΩ
---------

1429 kΩ
---------

<b>Measuring current (max.)</b>
---------------------------------

1 A	5 A
-----	-----

Rogowski coils
----------------

<b>Input resistance (current path) typ.</b>
---

22 mΩ	5 mΩ
-------	------

44 kΩ
-------

<b>Resolution</b>
-------------------

24 bits
---------

24 bits
---------

<b>Measuring error max., 25 °C</b>
------------------------------------

AC current/voltage: ±0.5 % of the upper-range value
--

AC current/voltage: ±0.5 % of the upper-range value
--

<b>Frequency range (mains frequency)</b>
--

45 ... 65 Hz
--------------

45 ... 65 Hz
--------------

<b>Frequency range (harmonics analysis)</b>
---

0 ... 3300 Hz
---------------

0 ... 3300 Hz
---------------

<b>Limit frequency</b>
------------------------

15.9 kHz
----------

15.9 kHz
----------

<b>Current consumption – system supply (5 V)</b>
--

100 mA
--------

100 mA
--------

<b>Rated surge voltage</b>
----------------------------

5.0 kV (EN 60870-2-1 / Class VW3); 6.0 kV (UL 508); 6.0 kV (EN 60664-1 / to 4,000 m ASL); 4.0 kV (EN 60664-1 / > 4,000 m to 5,000 m ASL)
---

5.0 kV (EN 60870-2-1 / Class VW3); 6.0 kV (UL 508); 6.0 kV (EN 60664-1 / to 4,000 m ASL); 4.0 kV (EN 60664-1 / > 4,000 m to 5,000 m ASL)
---

<b>Overvoltage category</b>
-----------------------------

Nominal voltage 400 V/690 V in a 3-phase system: III (EN 60664-1 / to 4,000 m ASL); II (EN 60664-1 / > 4,000 m up to 5,000 m ASL)
---

Nominal voltage 400 V/690 V in a 3-phase system: III (EN 60664-1 / to 4,000 m ASL); II (EN 60664-1 / > 4,000 m up to 5,000 m ASL)
---

<b>Data width</b>
-------------------

2 x 128-bit data; 2 x 64-bit control/status
---

2 x 128-bit data; 2 x 64-bit control/status
---

<b>Surrounding air temperature (operation)</b>
--

-40 ... +70 °C
----------------

-40 ... +70 °C
----------------

<b>Dimensions W x H x D</b>
-----------------------------

24 x 67.8 x 100 mm
--------------------

24 x 67.8 x 100 mm
--------------------

<b>Approvals</b>
------------------

CE; Marine; ATEX/IECEx
------------------------

CE; Marine; ATEX/IECEx
------------------------

<b>Data sheet and further information, see:</b>
---

<a href="http://wago.com/750-495/040-000">wago.com/750-495/040-000</a>	<a href="http://wago.com/750-495/040-001">wago.com/750-495/040-001</a>
--	--

<a href="http://wago.com/750-495/040-002">wago.com/750-495/040-002</a>
--

**Accessories**

Split-core and plug-in current transformers
Rogowski coils

<b>Item no.</b>
-----------------

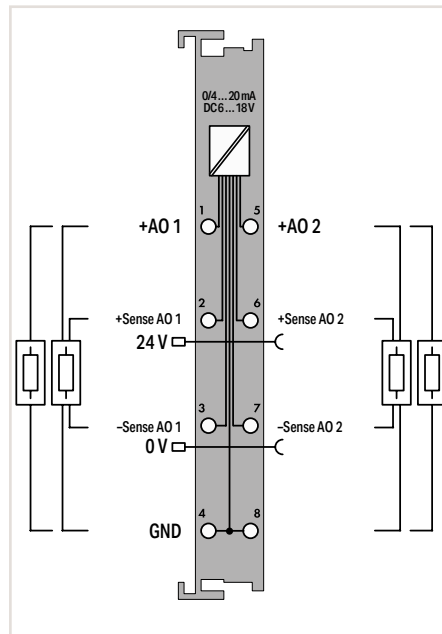
See Full Line Catalog, Volume 4
---------------------------------

<b>Item no.</b>
-----------------

See Full Line Catalog, Volume 4
---------------------------------

6

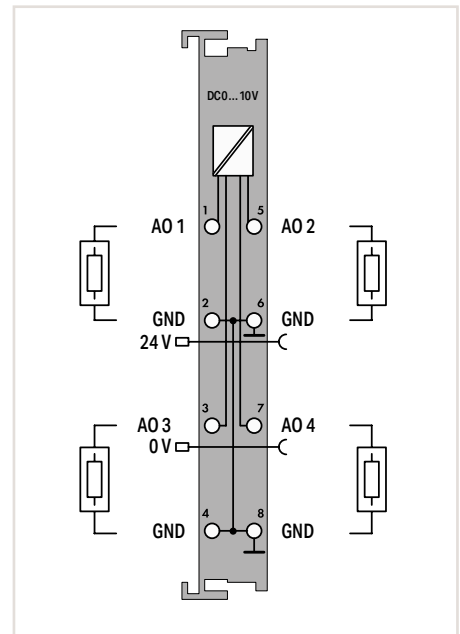
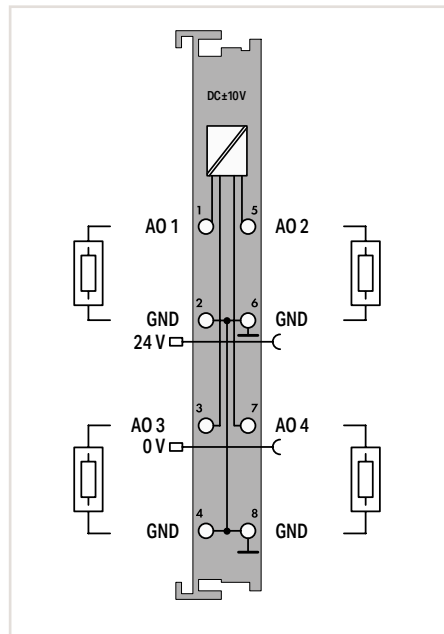
## Analog Output; Configurable 0/4 ... 20 mA; 6 ... 18 VDC



Item Description	2-Channel Analog Output; 0/4 ... 20 mA; 16 bits; 6 ... 18 VDC
Version	Extreme
Item no.	750-563/040-000
Order text	2AO; 0/4-20mA; 16Bit; 6-18 VDC; XTR
<b>Technical Data</b>	
Number of analog outputs	2
Signal type	0 ... 20 mA; 4 ... 20 mA; 6 ... 18 V
Load impedance	> 1.8 k $\Omega$ (voltage output); < 500 $\Omega$ (current output)
Resolution	16 bits
Conversion time	5 ms
Output error max., 25 °C	$\pm 0.05$ % of the upper-range value
Temperature error max.	$\pm 100$ ppm
Supply voltage (field)	24 VDC (-15 ... 30 %); via power jumper contacts (power supply via blade contact; transmission via spring contact); Specified values for surrounding air temperatures: +15 ... +35 °C; for -40 ... +55 °C: 24 V (min. ... +20 %); for +55 ... +70 °C: 24 V (min. ... +10 %); Voltage range (min.): 21.6 V; Current range (min.): 20.4 V; Lower limit in all temperature ranges: -27.5 % (including 15 % residual ripple)
Current consumption – system supply (5 V)	80 ... 110 mA
Rated surge voltage	1 kV
Data width	2 x 16-bit data; 2 x 8-bit control/status (optional)
Surrounding air temperature (operation)	-40 ... +70 °C
Dimensions W x H x D	12 x 67.8 x 100 mm
Approvals	CE; Marine; OrdLoc/HazLoc; ATEX/IECEX
Data sheet and further information, see:	<a href="http://wago.com/750-563/040-000">wago.com/750-563/040-000</a>

„ Mini-WSB marker card and mounting accessories,  
see Section “Accessories and Tools”

„ Approvals and corresponding ratings,  
see page 526 or [www.wago.com](http://www.wago.com)

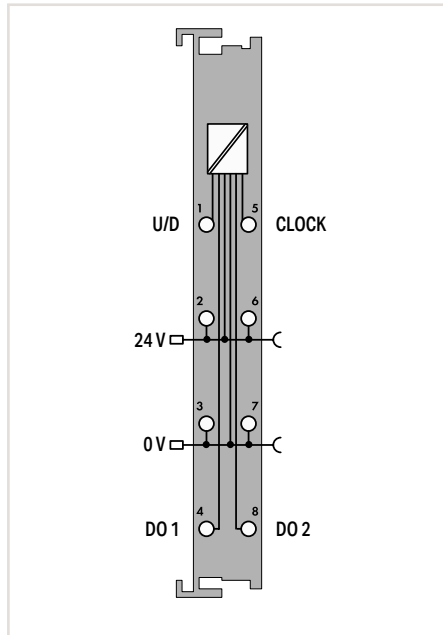
Analog Output;  $\pm 10$  VDC or 0 ... 10 VDC

Item Description	4-Channel Analog Output; $\pm 10$ VDC	4-Channel Analog Output; 0 ... 10 VDC
Version	Extreme	Extreme
Item no.	750-557/040-000	750-559/040-000
Order text	4AO; $\pm 10$ V DC; XTR	4AO; 0-10 V DC; XTR
<b>Technical Data</b>		
Number of analog outputs	4	4
Signal type	$\pm 10$ V	0 ... 10 V
Load impedance	> 5 k $\Omega$	> 5 k $\Omega$
Resolution	12 bits	12 bits
Conversion time	10 ms	10 ms
Output error max., 25 °C	$\pm 0.1$ % of the upper-range value	$\pm 0.1$ % of the upper-range value
Temperature error max.	$\pm 0.01$ % / K of the upper-range value	$\pm 0.01$ % / K of the upper-range value
Supply voltage (field)	24 VDC (-25 ... 30 %); via power jumper contacts (power supply via blade contact; transmission via spring contact); Specified values for surrounding air temperature: +15 ... +35 °C; for -40 ... +55 °C: 24 V (-25 ... +20 %); for +55 ... +70 °C: 24 V (-25 ... +10 %); Lower limit in all temperature ranges: -27.5 % (including 15 % residual ripple)	24 VDC (-25 ... 30 %); via power jumper contacts (power supply via blade contact; transmission via spring contact); Specified values for surrounding air temperature: +15 ... +35 °C; for -40 ... +55 °C: 24 V (-25 ... +20 %); for +55 ... +70 °C: 24 V (-25 ... +10 %); Lower limit in all temperature ranges: -27.5 % (including 15 % residual ripple)
Current consumption – system supply (5 V)	125 mA	125 mA
Rated surge voltage	1 kV	1 kV
Data width	4 x 16-bit data; 4 x 8-bit control/status (optional)	4 x 16-bit data; 4 x 8-bit control/status (optional)
Surrounding air temperature (operation)	-40 ... +70 °C	-40 ... +70 °C
Dimensions W x H x D	12 x 67.8 x 100 mm	12 x 67.8 x 100 mm
Approvals	CE;  Marine;  OrdLoc/HazLoc; ATEX/IECEX	CE;  Marine;  OrdLoc/HazLoc; ATEX/IECEX
Data sheet and further information, see:	<a href="http://wago.com/750-557/040-000">wago.com/750-557/040-000</a>	<a href="http://wago.com/750-559/040-000">wago.com/750-559/040-000</a>

„ Mini-WSB marker card and mounting accessories, see Section "Accessories and Tools"

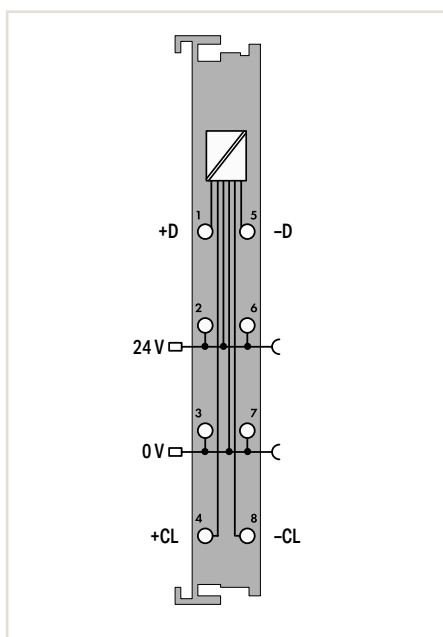
„ Approvals and corresponding ratings, see page 526, 527 or [www.wago.com](http://www.wago.com)

## Counter



<b>Item Description</b>	<b>Counter; adjustable</b>
<b>Version</b>	<b>Extreme</b>
<b>Item no.</b>	<b>750-404/040-003</b>
<b>Order text</b>	Counter; Adjust; XTR
<b>Technical Data</b>	
No. of outputs	2
Number of counters	1
Voltage range for signal (0)	-3 ... +5 VDC
Voltage range for signal (1)	15 ... 30 VDC
Output current	0.5 A; short-circuit-protected
Switching frequency (max.)	100 kHz
Pulse width (min.)Pulse width (min.)	10 µs
Input current (typ.)	7 mA
Counter depth	32 bits
Supply voltage (field)	24 VDC (-25 ... 30 %); via power jumper contacts (power supply via blade contact; transmission via spring contact); Specified values for surrounding air temperature: +15 ... +35 °C; for -40 ... +55 °C: 24 V (-25 ... +20 %); for +55 ... +70 °C: 24 V (-25 ... +10 %); Lower limit in all temperature ranges: -27.5 % (including 15 % residual ripple)
Current consumption – system supply (5 V)	70 mA
Rated surge voltage	1 kV
Data width (internal)	32-bit data; 8-bit control/status
Operating modes	Up/down counter/100 kHz; Up counter/enable input; Peak-time counter; Frequency measurement: 0.1 Hz ... 100 kHz*; Up/down counter/signal outputs (DO); Two up counters/16 bits/5 kHz *Default setting
Surrounding air temperature (operation)	-40 ... +70 °C
Dimensions W x H x D	12 x 67.8 x 100 mm
<b>Approvals</b>	CE; Marine; OrdLoc/HazLoc; ATEX/IECEX
<b>Data sheet and further information, see:</b>	<a href="http://wago.com/750-404/040-003">wago.com/750-404/040-003</a>

## SSI Transmitter Interface

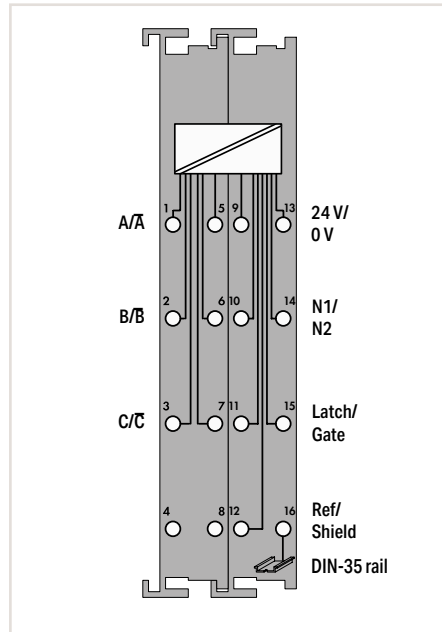


<b>Item Description</b>	<b>SSI Transmitter Interface; adjustable</b>
<b>Version</b>	<b>Extreme</b>
<b>Item no.</b>	<b>750-630/040-001</b>
<b>Order text</b>	SSI Interface; Adjust; XTR
<b>Technical Data</b>	
Transmitter connection	On + D; - D; Off + Cl; - Cl
Transmitter supply	24 VDC; via power jumper contacts
Baud rate	62.5 ... 250 kHz
Serial input	Data width: 1 ... 32 bits
Signal output	Differential signal (RS-422)
Signal input	Differential signal (RS-422)
Code	Gray code/binary code
Supply voltage (field)	24 VDC (-25 ... 30 %); via power jumper contacts (power supply via blade contact; transmission via spring contact); Specified values for surrounding air temperature: +15 ... +35 °C; for -40 ... +55 °C: 24 V (-25 ... +20 %); for +55 ... +70 °C: 24 V (-25 ... +10 %); Lower limit in all temperature ranges: -27.5 % (including 15 % residual ripple)
Current consumption – system supply (5 V)	20 mA
Data width (internal)	1 x 32-bit; 1 x 8-bit control/status (optional) (24-bit data, 8 bits reserved)
Rated surge voltage	1 kV
Surrounding air temperature (operation)	-40 ... +70 °C
Dimensions W x H x D	12 x 67.8 x 100 mm
<b>Approvals</b>	CE; Marine; OrdLoc/HazLoc; ATEX/IECEX
<b>Data sheet and further information, see:</b>	<a href="http://wago.com/750-630/040-001">wago.com/750-630/040-001</a>

„ Mini-WSB marker card and mounting accessories, see Section “Accessories and Tools”

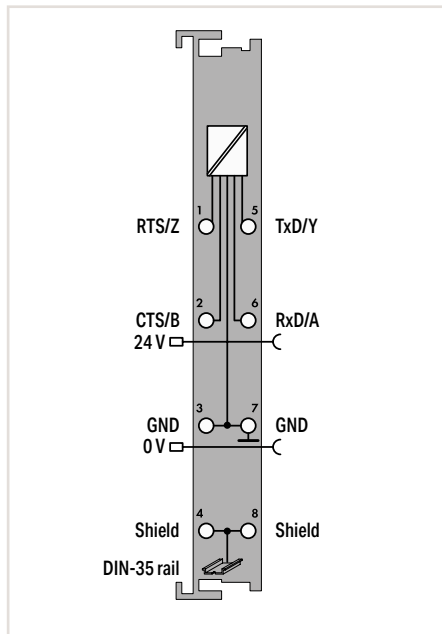
„ Approvals and corresponding ratings, see page 527 or [www.wago.com](http://www.wago.com)

## Incremental Encoder Interface



Item Description	Incremental Encoder Interface; 24 VDC; Differential input; 32 bits
Version	Extreme
Item no.	750-637/040-001
Order text	Inc. Encoder; 24 VDC; Diff; 32Bit; XTR
<b>Technical Data</b>	
Transmitter connection	A; /A; B; /B; C; /C (differential inputs)
Counter	32 bits (binary)
Limit frequency	250 kHz
Quadrature decoder	4x report
Zero impulse latch	32 bits
Commands	Reading; setting; activating
Current consumption (typ.)	35 mA; without transmitter
Output voltage	24 VDC
Output current (max.)	0.5 A; short-circuit-protected
Voltage range for signal (0)	( $U_{ABC} - U_{ABC}$ ): -30 ... +15 VDC; Latch, Gate, Ref.: -3 ... +5 VDC
Voltage range for signal (1)	( $U_{ABC} - U_{ABC}$ ): 15 ... 30 VDC; Latch, Gate, Ref.: 15 ... 30 VDC
Input current (typ.)	Latch 7 mA; gate 7 mA; ref. 7 mA
Current consumption – system supply (5 V)	110 mA
Data width (internal)	1 x 32-bit data; 2 x 8-bit control/status
Rated surge voltage	1 kV
Surrounding air temperature (operation)	-40 ... +70 °C
Dimensions W x H x D	24 x 67.8 x 100 mm
Approvals	CE; Marine; OrdLoc/HazLoc; ATEX/IECEX
Data sheet and further information, see:	<a href="http://wago.com/750-637/040-001">wago.com/750-637/040-001</a>

## Serial Interface RS-232/485



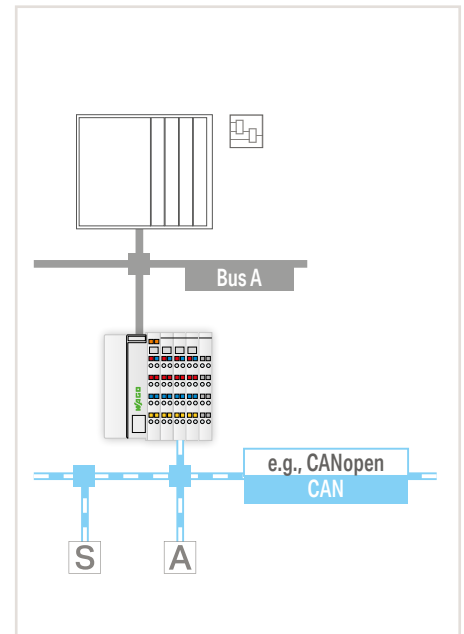
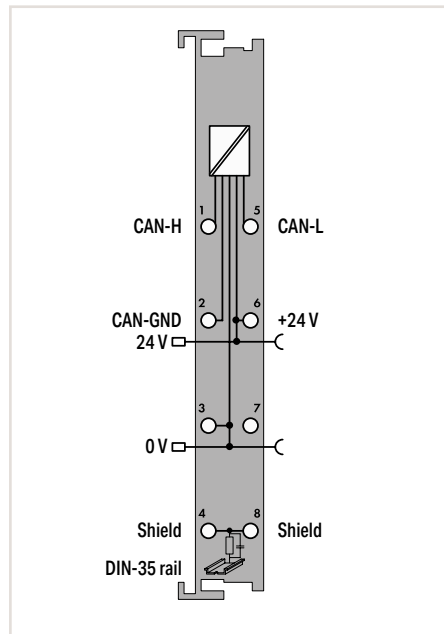
<b>Item Description</b>	<b>Serial Interface RS-232/485</b>
<b>Version</b>	<b>Extreme</b>
<b>Item no.</b>	750-652/040-000
<b>Order text</b>	RS232/485 Interface; XTR
<b>Technical Data</b>	
Signal type	RS-232; RS-422; RS-485
Transmission channels	1 TxD / 1 RxD; full-duplex; half-duplex
Baud rate	9600 Bd (default setting); 300 ... 115200 Bd
Parity	None/Odd/Even
Number of data bits	7/8; adjustable
Number of stop bits	1/2; adjustable
Buffer	2560 bytes for reception; 512 bytes for transmission
Supply voltage (field)	24 VDC (-25 ... 30 %); via power jumper contacts (power supply via blade contact; transmission via spring contact); Specified values for surrounding air temperature: +15 ... +35 °C; for -40 ... +55 °C: 24 V (-25 ... +20 %); for +55 ... +70 °C: 24 V (-25 ... +10 %); Lower limit in all temperature ranges: -27.5 % (including 15 % residual ripple)
Current consumption – system supply (5 V)	85 mA
Rated surge voltage	1 kV
Data width (internal)	8, 24 or 48 bytes (parametrizable)
Surrounding air temperature (operation)	-40 ... +70 °C
Dimensions W x H x D	12 x 67.8 x 100 mm
<b>Approvals</b>	CE; Marine; OrdLoc/HazLoc; ATEX/IECEX
<b>Data sheet and further information, see:</b>	<a href="http://wago.com/750-652/040-000">wago.com/750-652/040-000</a>

„ Mini-WSB marker card and mounting accessories, see Section “Accessories and Tools”

„ Approvals and corresponding ratings, see page 527 or [www.wago.com](http://www.wago.com)



## CAN Gateway



<b>Item Description</b>	<b>CAN Gateway</b>
<b>Version</b>	<b>Extreme</b>
<b>Item no.</b>	<b>750-658/040-000</b>
<b>Order text</b>	CAN Gateway; XTR
<b>Technical Data</b>	
Number of CAN interfaces	1
Baud rate	10 kbit/s; 20 kbit/s; 50 kbit/s; 125 kbit/s; 250 kbit/s; 500 kbit/s; 800 kbit/s; 1 Mbit/s (automatic baud rate)
Data formats	Per 2.0 A standard (11-bit ID); Per 2.0 B extended (29-bit ID)
Operating modes	Sniffer mode; Transparent mode; Mapped mode
Current consumption – system supply (5 V)	50 mA
Supply voltage (field)	24 VDC; via power jumper contacts (power supply via blade contact; transmission via spring contact)
Current consumption (field supply) (module with no external load)	15 mA
Data transfer time	5 ms (at 32-bit I/O)
Data width (internal)	8, 12, 16, 20, 24, 32, 40, 48 bytes Configurable; including 1 control/status byte
Rated surge voltage	1 kV
Surrounding air temperature (operation)	-40 ... +70 °C
Dimensions W x H x D	12 x 67.8 x 100 mm
<b>Approvals</b>	CE; Marine; OrdLoc/HazLoc; ATEX/IECEx
<b>Data sheet and further information, see:</b>	<a href="http://wago.com/750-658/040-000">wago.com/750-658/040-000</a>

The CAN Gateway allows a CAN bus to be installed as a sub-bus beneath a fieldbus coupler or controller. It enables special sensors/actuators that are only available with the widely spread CAN bus to also be integrated under other bus systems. Function blocks allow the gateway to read and write higher-protocol telegrams (e.g., CANopen).

The module offers three different operating modes:

- Sniffer mode: Detailed analysis of the CAN bus through passive "snooping"
- Transparent mode: Active CAN subscriber that can send and receive any type of CAN telegram
- Mapped mode: Enables direct generation of CAN telegrams from the process image, or selective copying of process values from received CAN telegrams into the input process image (cyclic or event-based)

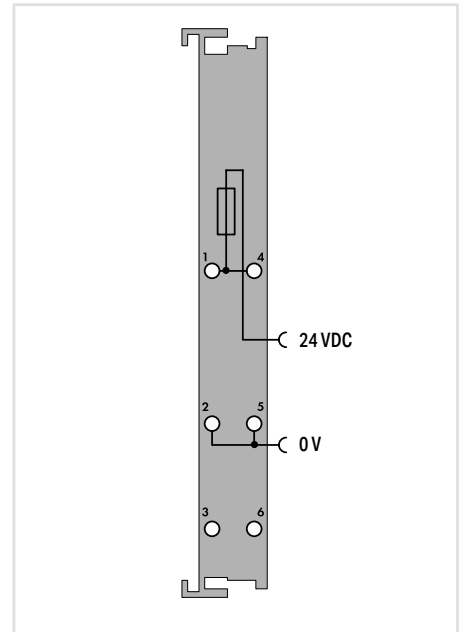
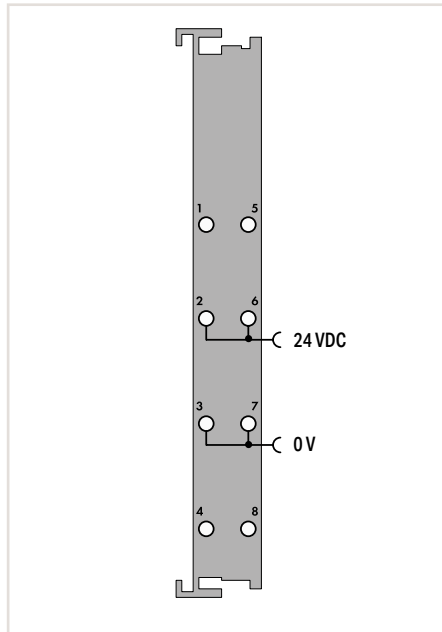
# Power Supply; 24 VDC or 0 ... 230 VAC/DC System Power Supply; 24 VDC



Figure: 750-602/040-000



Figure: 750-601/040-000



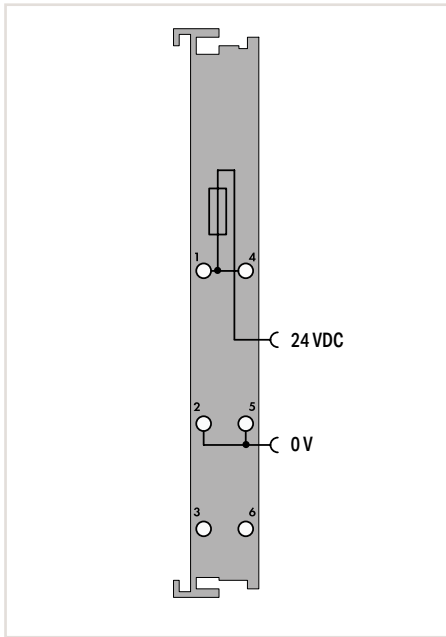
Item Description	Power Supply; 24 VDC	Power Supply; 24 VDC; Fuse holder
Version	Extreme	Extreme
Item no.	750-602/040-000	750-601/040-000
Order text	Power Supply; 24 VDC; XTR	Power Supply; 24 VDC; Fuse; XTR
<b>Technical Data</b>		
Supply voltage (system)	5 VDC; via data contacts	5 VDC; via data contacts
Input current (typ.) at nominal load (24 V)		
Total current (system supply)		
Supply voltage (field)	24 VDC (-25 ... 30 %); via power jumper contacts (power supply via CAGE CLAMP® connection; transmission via spring contact); Specified values for surrounding air temperatures: +15 ... +35 °C; for -40 ... +55 °C: 24 V (-25 ... +20 %); for +55 ... +70 °C: 24 V (-25 ... +10 %); Lower limit in all temperature ranges: -27.5 % (including 15 % residual ripple)	24 VDC (-25 ... 30 %); via power jumper contacts (power supply via CAGE CLAMP® connection; transmission via spring contact); Specified values for surrounding air temperatures: +15 ... +35 °C; for -40 ... +55 °C: 24 V (-25 ... +20 %); for +55 ... +70 °C: 24 V (-25 ... +10 %); Lower limit in all temperature ranges: -27.5 % (including 15 % residual ripple)
Current carrying capacity (power jumper contacts)	10 A	10 A
Fuse	5 x 20; T max. 6.3 A (not included)	
<b>Diagnostics</b>		
Current consumption – system supply (5 V)		
Data width (internal)		
Rated surge voltage	1 kV	1 kV
<b>Overvoltage category</b>		
Surrounding air temperature (operation)	-40 ... +70 °C	-40 ... +70 °C
Dimensions W x H x D	12 x 67.8 x 100 mm	12 x 67.8 x 100 mm
Approvals	CE; Marine; OrdLoc/HazLoc; ATEX/IECEx	CE; Marine; OrdLoc/HazLoc; ATEX/IECEx
Data sheet and further information, see:	<a href="http://wago.com/750-602/040-000">wago.com/750-602/040-000</a>	<a href="http://wago.com/750-601/040-000">wago.com/750-601/040-000</a>

This I/O module provides the applied supply voltage to the field devices connected to downstream I/O modules.

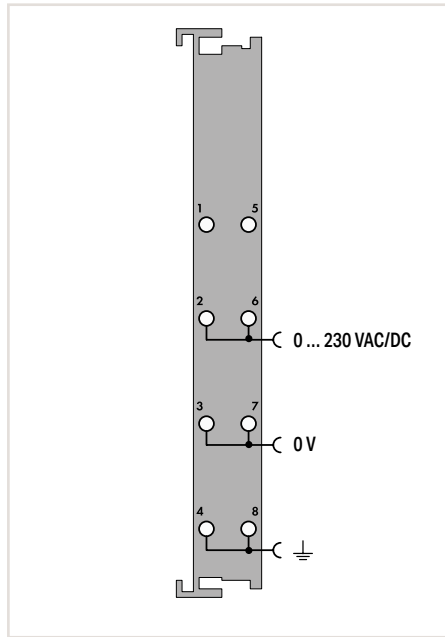
This I/O module provides the applied supply voltage, protected by fuse, to the field devices connected to downstream I/O modules. A blown fuse is indicated by an LED.

„ Mini-WSB marker card and mounting accessories, see Section "Accessories and Tools"

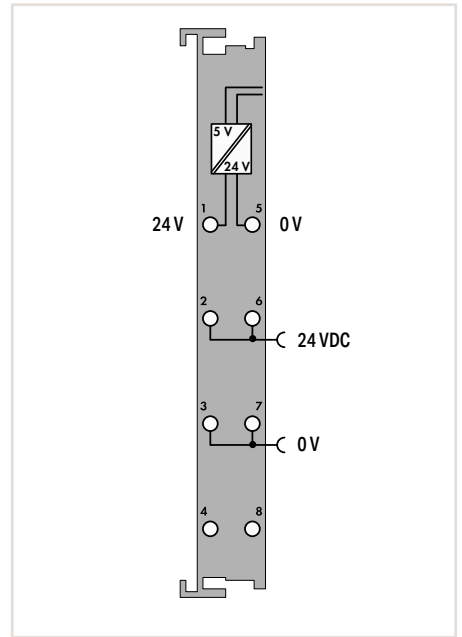
„ Approvals and corresponding ratings, see page 527 or [www.wago.com](http://www.wago.com)



**Power Supply; 24 VDC; Fuse holder; Diagnostics**  
**Extreme**  
 750-610/040-000  
 Power Supply; 24 VDC; Fuse Diagn; XTR



**Power Supply; 0 ... 230 VAC/DC**  
**Extreme**  
 750-612/040-000  
 Power Supply; 0-230 VAC/VDC; XTR



**System Power Supply; 24 VDC**  
**Extreme**  
 750-613/040-000  
 System Power Supply; 24 VDC; XTR

5 VDC; via data contacts

5 VDC; via data contacts

24 VDC (-25 ... +30 %); power supply and transmission via CAGE CLAMP® connection

24 VDC (-25 ... 30 %); via power jumper contacts (power supply via CAGE CLAMP® connection; transmission via spring contact); Specified values for surrounding air temperatures: +15 ... +35 °C; for -40 ... +55 °C: 24 V (-25 ... +20 %); for +55 ... +70 °C: 24 V (-25 ... +10 %); Lower limit in all temperature ranges: -27.5 % (including 15 % residual ripple)

0 ... 230 VAC/DC (-20 ... 25 %); via power jumper contacts (power supply via CAGE CLAMP® connection; transmission via spring contact)

24 VDC (-25 ... 30 %); via power jumper contacts (power supply via CAGE CLAMP® connection; transmission via spring contact); Specified values for surrounding air temperatures: +15 ... +35 °C; for -40 ... +55 °C: 24 V (-25 ... +20 %); for +55 ... +70 °C: 24 V (-25 ... +10 %); Lower limit in all temperature ranges: -27.5 % (including 15 % residual ripple)

6.3 A

6.3 A

500 mA  
 2000 mA  
 10 A

5 x 20; T max. 6.3 A (not included)

Supply voltage (field): Detection "on" at > 15 VDC; Detection "off" at < 5 VDC

5 mA

2 bits (1 bit current monitoring; 1 bit fuse fault)

5.0 kV (EN 60870-2-1 / Class VW3); 6.0 kV (UL 508); 6.0 kV (EN 60664-1 / to 4,000 m ASL); 4.0 kV (EN 60664-1 / > 4,000 m to 5,000 m ASL)

1 kV

1 kV

Nominal voltage 230 V: IV (EN 60664-1 / to 4,000 m ASL); III (EN 60664-1 / > 4,000 m to 5,000 m ASL)

1 kV

-40 ... +70 °C

-40 ... +70 °C

-40 ... +70 °C

12 x 67.8 x 100 mm

12 x 67.8 x 100 mm

12 x 67.8 x 100 mm

CE; Marine; OrdLoc/HazLoc; ATEX/IECEx

CE; Marine; OrdLoc/HazLoc; ATEX/IECEx

CE; Marine; OrdLoc/HazLoc; ATEX/IECEx

wago.com/750-610/040-000

wago.com/750-612/040-000

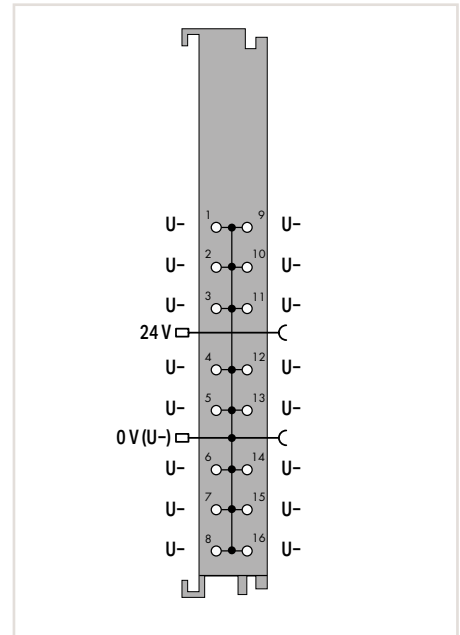
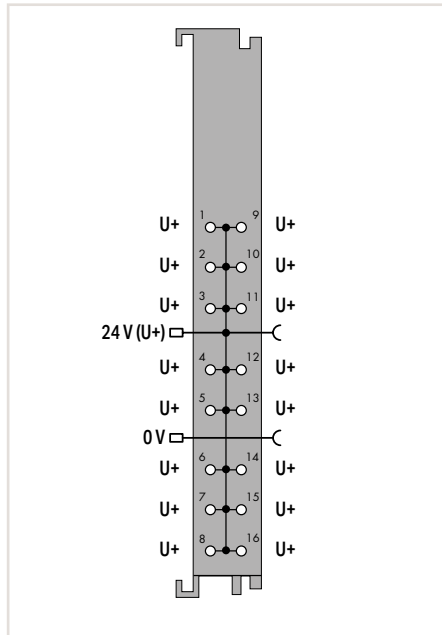
wago.com/750-613/040-000

This I/O module provides the applied supply voltage, protected by fuse, to the field devices connected to downstream I/O modules. A blown fuse is indicated by an LED. The fuse status can also be queried from the fieldbus coupler.

This I/O module provides the applied supply voltage to the field devices connected to downstream I/O modules.

This I/O module provides the applied supply voltage to the field devices connected to downstream I/O modules. It also serves as an additional system supply for large nodes, covering the power demands of the I/O modules themselves.

# Potential Distribution

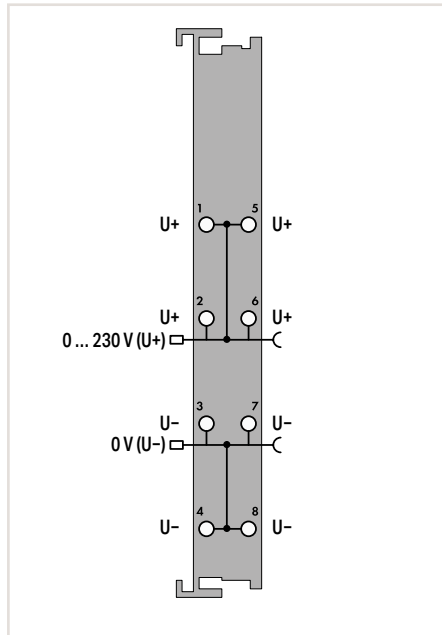


Item Description	Potential Distribution; 16x 24 V	Potential Distribution; 16x 0 V
Version	Extreme	Extreme
Item no.	750-1605/040-000	750-1606/040-000
Order text	Potential Distribution; 16*24V; XTR	Potential Distribution; 16*0V; XTR
<b>Technical Data</b>		
Supply voltage (field)	24 VDC (-25 ... +30 %); via power jumper contacts (power supply via blade contact; transmission via spring contact); Specified values for surrounding air temperatures: +15 ... +35 °C For -40 ... +55 °C: 24 V (-25 ... +20 %); For +55 ... +70 °C: 24 V (-25 ... +10 %); Lower limit in all temperature ranges: -27.5 % (including 15 % residual ripple)	24 VDC (-25 ... +30 %); via power jumper contacts (power supply via blade contact; transmission via spring contact); Specified values for surrounding air temperatures: +15 ... +35 °C For -40 ... +55 °C: 24 V (-25 ... +20 %); For +55 ... +70 °C: 24 V (-25 ... +10 %); Lower limit in all temperature ranges: -27.5 % (including 15 % residual ripple)
Current carrying capacity (power jumper contacts)	10 A	10 A
Rated surge voltage	1 kV	1 kV
Surrounding air temperature (operation)	-40 ... +70 °C	-40 ... +70 °C
Dimensions W x H x D	12 x 69 x 100 mm	12 x 69 x 100 mm
Approvals	CE; Marine; OrdLoc/HazLoc; ATEX/IECEX	CE; Marine; OrdLoc/HazLoc; ATEX/IECEX
Data sheet and further information, see:	<a href="http://wago.com/750-1605/040-000">wago.com/750-1605/040-000</a>	<a href="http://wago.com/750-1606/040-000">wago.com/750-1606/040-000</a>

6

„ Mini-WSB marker card and mounting accessories, see Section "Accessories and Tools"  
 „ Approvals and corresponding ratings, see page 527 or [www.wago.com](http://www.wago.com)

## Potential Distribution



<b>Item Description</b>	<b>Potential Distribution</b>
<b>Version</b>	<b>Extreme</b>
<b>Item no.</b>	<b>750-614/040-000</b>
<b>Order text</b>	Potential Distribution; XTR
<b>Technical Data</b>	
Supply voltage (field)	0 ... 230 VAC/DC; via power jumper contacts (power supply via blade contact; transmission via spring contact)
Current carrying capacity (power jumper contacts)	10 A
Rated surge voltage	5.0 kV (EN 60870-2-1 / Class VW3); 6.0 kV (UL 61010); 6.0 kV (EN 60664-1 / to 4,000 m ASL); 4.0 kV (EN 60664-1 / > 4,000 m to 5,000 m ASL)
Surrounding air temperature (operation)	-40 ... +70 °C
Dimensions W x H x D	12 x 67.8 x 100 mm
<b>Approvals</b>	CE; Marine; OrdLoc/HazLoc; ATEX/IECEX
<b>Data sheet and further information, see:</b>	<a href="http://wago.com/750-614/040-000">wago.com/750-614/040-000</a>

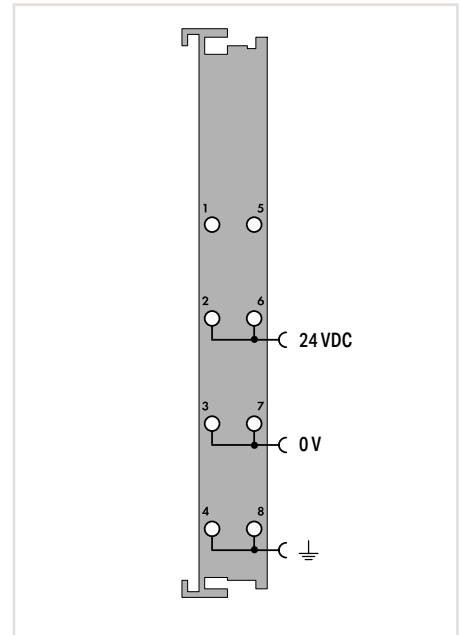
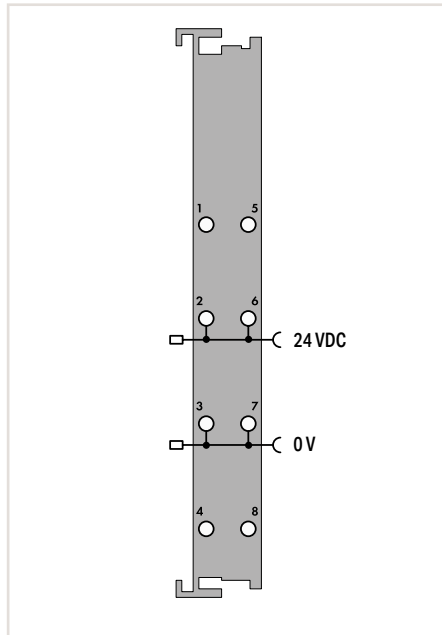
## Field Supply Filter (Surge)



Figure: 750-624/040-000



Figure: 750-624/040-001

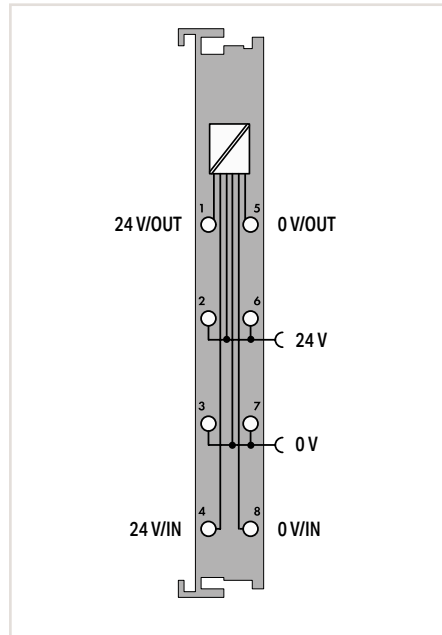


Item Description	Field Supply Filter (Surge); 24 VDC; Higher isolation	Field Supply Filter (Surge); 24 VDC; Higher isolation
Version	Extreme	Without power jumper contacts; extreme
Item no.	750-624/040-000	750-624/040-001
Order text	Field Supply Filter; 24 VDC; HI; XTR	Field Supply Filter; 24 VDC; HI; NC; XTR
<b>Technical Data</b>		
Supply voltage (field)	24 VDC (–25 ... +30 %); via power jumper contacts (power supply via blade contact; transmission via spring contact); Specified values for surrounding air temperatures: +15 ... +35 °C For –40 ... +55 °C: 24 V (–25 ... +20 %); For +55 ... +70 °C: 24 V (–25 ... +10 %); Lower limit in all temperature ranges: –27.5 % (including 15 % residual ripple)	24 VDC (–25 ... +30 %); via power jumper contacts (power supply via CAGE CLAMP® connection; transmission via spring contact); Specified values for surrounding air temperature: +15 ... +35 °C; For –40 ... +55 °C: 24 V (–25 ... +20 %); For +55 ... +70 °C: 24 V (–25 ... +10 %); Lower limit in all temperature ranges: –27.5 % (including 15 % residual ripple)
Current carrying capacity (power jumper contacts)	10 A	10 A
Rated surge voltage	1 kV	1 kV
Use	In marine and onshore/offshore applications, as well as in telecontrol and rail technology	In marine and onshore/offshore applications, as well as in telecontrol and rail technology
Surrounding air temperature (operation)	–40 ... +70 °C	–40 ... +70 °C
Dimensions W x H x D	12 x 67.8 x 100 mm	12 x 67.8 x 100 mm
Approvals	CE; Marine; OrdLoc/HazLoc; ATEX/IECEX	CE; Marine; OrdLoc/HazLoc; ATEX/IECEX
Data sheet and further information, see:	<a href="http://wago.com/750-624/040-000">wago.com/750-624/040-000</a>	<a href="http://wago.com/750-624/040-001">wago.com/750-624/040-001</a>

6

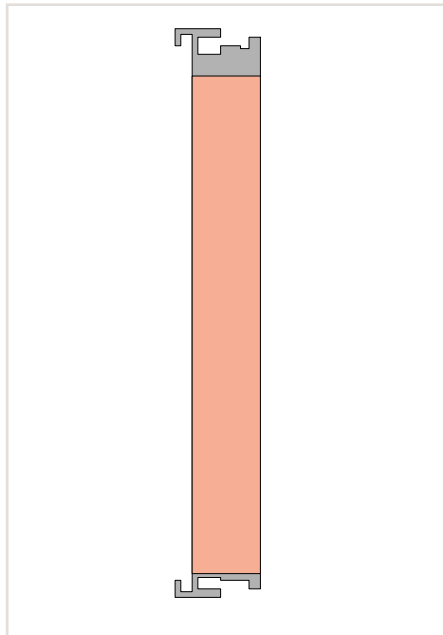
„ Mini-WSB marker card and mounting accessories, see Section “Accessories and Tools”  
 „ Approvals and corresponding ratings, see page 527 or [www.wago.com](http://www.wago.com)

## Supply Filter



<b>Item Description</b>	<b>Supply Filter; 24 VDC; Higher isolation</b>
<b>Version</b>	<b>Extreme</b>
<b>Item no.</b>	<b>750-626/040-000</b>
<b>Order text</b>	Supply Filter; 24 VDC; HI; XTR
<b>Technical Data</b>	
Supply voltage (system)	24 VDC (-25 ... +30 %); power supply and transmission via CAGE CLAMP® connection
Current via system voltage (max.)	1.5 A
Supply voltage (field)	24 VDC (-25 ... +30 %); via power jumper contacts (power supply via CAGE CLAMP® connection; transmission via spring contact) Specified values for surrounding air temperature: +15 ... +35 °C; For -40 ... +55 °C: 24 V (-25 ... +20 %); For +55 ... +70 °C: 24 V (-25 ... +10 %); Lower limit in all temperature ranges: -27.5 % (including 15 % residual ripple)
Current carrying capacity (power jumper contacts)	10 A
Rated surge voltage	1 kV
Use	In marine and onshore/offshore applications, as well as in telecontrol and rail technology
Surrounding air temperature (operation)	-40 ... +70 °C
Dimensions W x H x D	12 x 67.8 x 100 mm
<b>Approvals</b>	CE;  Marine;  OrdLoc/HazLoc; ATEX/IECEx
<b>Data sheet and further information, see:</b>	<a href="http://wago.com/750-626/040-000">wago.com/750-626/040-000</a>

## Distance Module



<b>Item Description</b>	<b>Distance Module</b>
<b>Version</b>	<b>Extreme</b>
<b>Item no.</b>	<b>750-616/040-000</b>
<b>Order text</b>	Distance Module; XTR
<b>Technical Data</b>	
Surrounding air temperature (operation)	-40 ... +70 °C
Dimensions W x H x D	12 x 69.8 x 100 mm
<b>Approvals</b>	CE;  Marine;  OrdLoc/HazLoc; ATEX/IECEX
<b>Data sheet and further information, see:</b>	<a href="http://wago.com/750-616/040-000">wago.com/750-616/040-000</a>

A distance module visually divides a fieldbus node into sections.

**Notice:**  
Operation of the adjacent I/O modules requires a supply module.

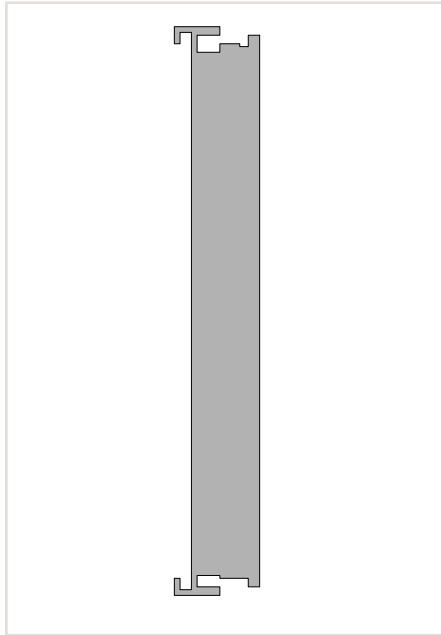
6

„ Mini-WSB marker card and mounting accessories, see Section “Accessories and Tools”

„ Approvals and corresponding ratings, see page 527 or [www.wago.com](http://www.wago.com)



## End Module



<b>Item Description</b>	<b>End Module</b>
<b>Version</b>	<b>Extreme</b>
<b>Item no.</b>	<b>750-600/040-000</b>
<b>Order text</b>	End Module; XTR
<b>Technical Data</b>	
Surrounding air temperature (operation)	-40 ... +70 °C
Dimensions W x H x D	12 x 67.8 x 100 mm
<b>Approvals</b>	CE;  Marine;  OrdLoc/HazLoc; ATEX/IECEX
<b>Data sheet and further information, see:</b>	<a href="http://wago.com/750-600/040-000">wago.com/750-600/040-000</a>

An end module must be snapped onto the assembly at the end of a fieldbus node. The end module completes the internal data bus, ensuring flawless data transmission.

# Intrinsically Safe XTR Modules



### Specialty housing

Dimensions W x H x D	48 x 70.9 x 100
Height from upper-edge of DIN-rail	63.7 mm
Connection technology	CAGE CLAMP®
Conductor cross section	0.25 ... 1.5 mm <sup>2</sup> / 24 ... 14 AWG
Strip length	5 ... 6 mm / 0.22 inch

### Housing design (750 Series)

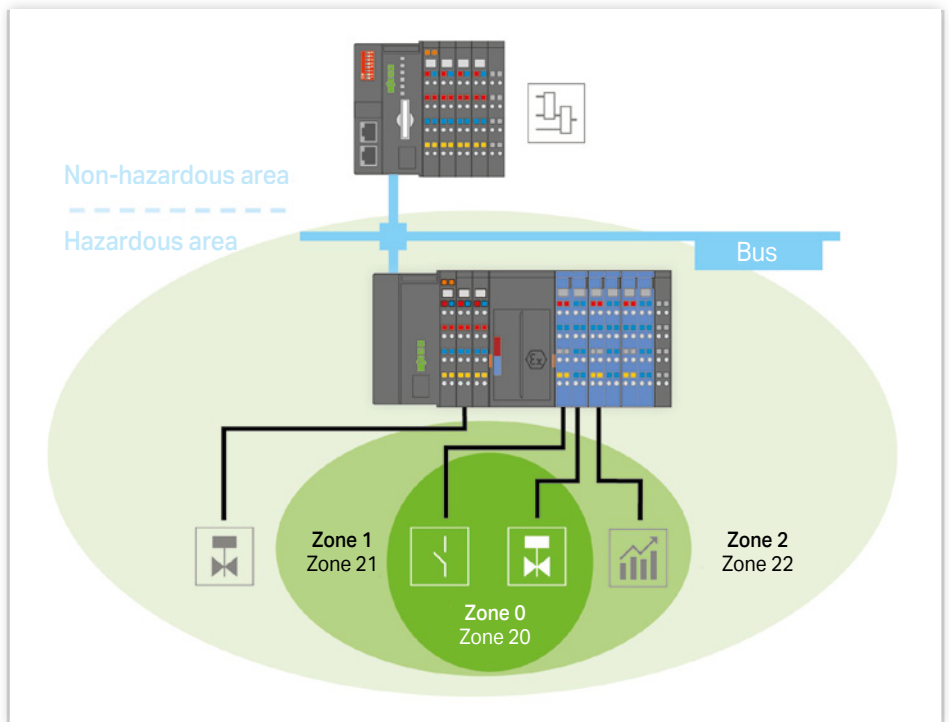
Dimensions W x H x D	12 or 24 x 67.8 x 100 mm
Height from upper-edge of DIN-rail	60.6 mm
Connection technology	CAGE CLAMP®
Conductor cross section	0.25 ... 2.5 mm <sup>2</sup> / 24 ... 14 AWG
Strip length	8 ... 9 mm / 0.33 inch



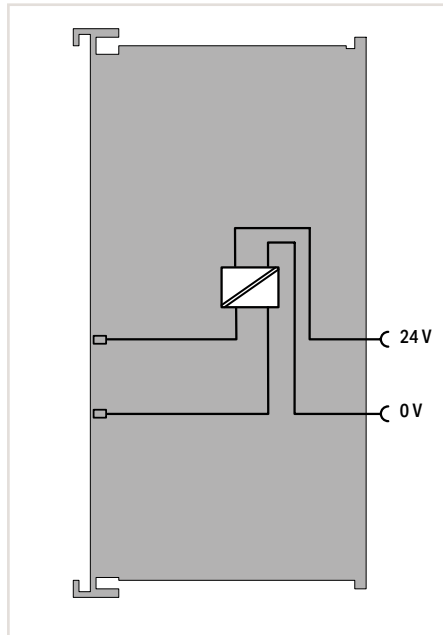
## 6

### Use in Hazardous Locations in eXTReme Environments

In many plants across the oil and gas industry, along with those in the chemical and petrochemical industries and the process automation sector, installations are operated that process explosive gas- or dust-air mixtures under extreme conditions. This is why electrical equipment must be explosion-proof in order to avoid injuries to personnel and damage to facilities. When used in hazardous areas of Zone 2/22, the WAGO-I/O-SYSTEM 750 XTR offers a safe, easy and economical connection to the sensors and actuators of Zones 0/20 and 1/21. Surrounding air temperatures from -40 to +70°C are permissible, as well as increased vibration loads up to 5g. The “blue” Ex i XTR I/O modules were specially developed for this purpose. They form an intrinsically safe section that can be integrated into a standard 750 XTR Series node, offering all the advantages of state-of-the-art fieldbus technology. The WAGO-I/O-SYSTEM 750 XTR is also approved for mining applications.



## Power Supply; 24 VDC; Extreme; for Intrinsically Safe XTR Modules



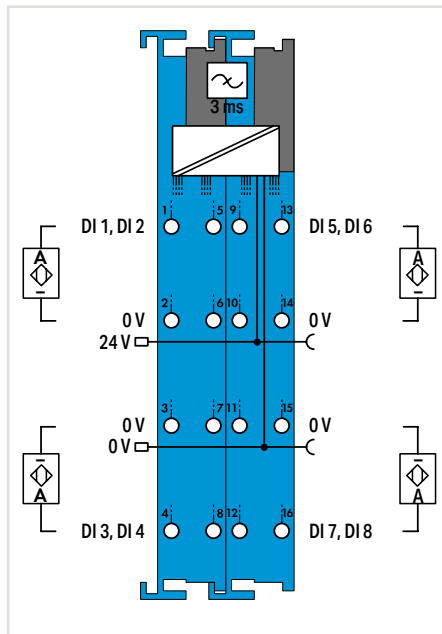
<b>Item Description</b>	<b>Power Supply; 24 VDC; intrinsically safe</b>
<b>Version</b>	<b>Extreme</b>
<b>Item no.</b>	<b>750-606/040-000</b>
<b>Order text</b>	Power Supply; 24 VDC; Ex i; XTR
<b>Technical Data</b>	
Current consumption – system supply (5 V)	7.5 mA
Supply voltage (field)	24 VDC; via power jumper contacts (power supply via CAGE CLAMP® connection; transmission via spring contact); Specified values for surrounding air temperatures: +15 ... +35 °C; for –40 ... +55 °C: 24 V (–25 ... +20 %); for +55 ... +70 °C: 24 V (–25 ... +10 %); Lower limit in all temperature ranges: –27.5 % (including 15 % residual ripple)
Current carrying capacity (power jumper contacts)	1 ADC
Fuse	Electronic
Data width	2 bits (input voltage failure; fuse triggered)
Surrounding air temperature (operation)	–40 ... +70 °C
Dimensions W x H x D	24 x 70.9 x 100 mm
<b>Explosion protection</b>	
Power supply (input)	$U_n = 24 \text{ VDC}; P_{\text{max}} = 29 \text{ W}; U_m = 253 \text{ V}$
Power supply (output)	$U_o = 26.8 \text{ V}$ (intrinsically safe output voltage per protection level ia); $I_n = 1 \text{ A}$
<b>Ex guideline</b>	EN/IEC 60079-0, -7, -11
<b>Approvals</b>	CE; Marine; OrdLoc/HazLoc; ATEX/IECEX
<b>Marking</b>	ATEX/IECEX: II 3G Ex ec IIC T4 Gc
<b>Data sheet and further information, see:</b>	<a href="http://wago.com/750-606/040-000">wago.com/750-606/040-000</a>

This supply module monitors power supply to the downstream Ex i segment and separates the intrinsically safe from the non-intrinsically safe section of the I/O system. Input and output sides are electrically isolated from each other.

Note: If, due to load conditions, more than one supply module is required per station, four distance modules (750-616/040-000) must be placed between the intrinsically safe sections.

General information (e.g., installation regulations) on explosion protection is available in the WAGO-I/O-SYSTEM 750 XTR manuals!

## 8-Channel Digital Input; NAMUR; Intrinsically Safe; Extreme



<b>Item Description</b>	<b>8-Channel Digital Input; NAMUR; intrinsically safe</b>
<b>Version</b>	<b>Extreme</b>
<b>Item no.</b>	<b>750-439/040-000</b>
<b>Order text</b>	<b>8DI; NAMUR; Ex i; XTR</b>
<b>Technical Data</b>	
Number of digital inputs	8
Signal type	NAMUR
Sensor connection	2-wire
Input characteristic	High-side switching
Input filter (digital)	3 ms
Open-circuit voltage	8.2 VDC
Diagnostics	Short circuit; wire break
Supply voltage (sensor)	8.2 VDC; short-circuit-protected; isolated channels
Supply voltage (field)	24 VDC (Ex i XTR power supply $U_o = \text{max. } 26.8 \text{ V}$ ); via power jumper contacts (power supply via blade contact; transmission via spring contact)
Current consumption – system supply (5 V)	56 mA
Data width (internal)	2 x 16 bits
Isolation	$U_m = 300 \text{ VAC system/supply}$
Surrounding air temperature (operation)	-40 ... +70 °C
Dimensions W x H x D	24 x 67.8 x 100 mm
<b>Explosion protection</b>	
Safety-relevant data (circuit)	$U_o = 11.76 \text{ V}$ ; $I_o = 12.48 \text{ mA}$ ; $P_o = 36.67 \text{ mW}$ ; Linear characteristic curve
Reactances Ex ia IIC	$L_o = 100 \text{ mH}$ ; $C_o = 1.5 \mu\text{F}$
Reactances Ex ia IIB	$L_o = 100 \text{ mH}$ ; $C_o = 9.9 \mu\text{F}$
Reactances Ex ia IIA	$L_o = 100 \text{ mH}$ ; $C_o = 39 \mu\text{F}$
Reactances Ex ia I	$L_o = 100 \text{ mH}$ ; $C_o = 38 \mu\text{F}$
<b>Ex guideline</b>	EN/IEC 60079-0, -7, -11
<b>Approvals</b>	CE; Marine; OrdLoc/HazLoc; ATEX/IECEX
<b>Marking</b>	Ⓢ ATEX/IECEX: II 3 (1) G Ex ec [ia Ga] IIC T4 Gc II (1) D [Ex ia Da] IIC I (M1) [Ex ia Ma] I
<b>Data sheet and further information, see:</b>	<a href="http://wago.com/750-439/040-000">wago.com/750-439/040-000</a>

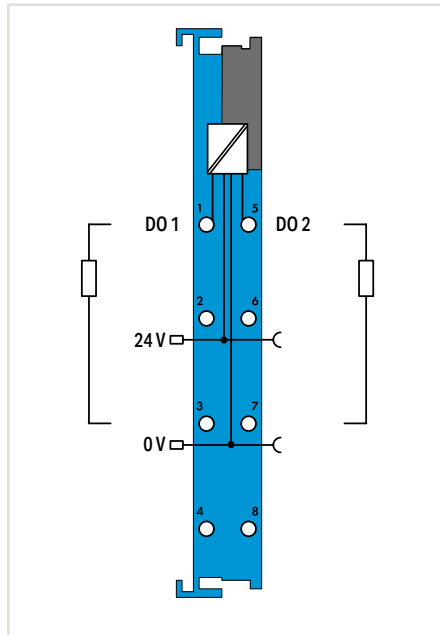
Reactances without accounting for the concurrence of capacitance ( $C_o$ ) and inductance ( $L_o$ )

6

„ Mini-WSB marker card and mounting accessories, see Section "Accessories and Tools"

„ Approvals and corresponding ratings, see page 526 or [www.wago.com](http://www.wago.com)

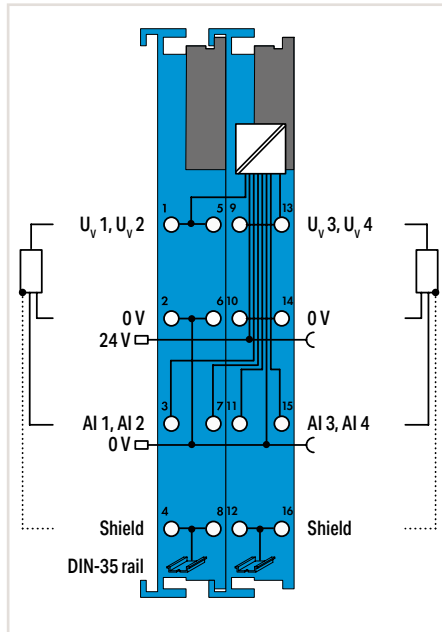
## 2-Channel Digital Output; 24 VDC; Intrinsically Safe; Extreme



<b>Item Description</b>	2-Channel Digital Output; 24 VDC; intrinsically safe
<b>Version</b>	Extreme
<b>Item no.</b>	750-535/040-000
<b>Order text</b>	2DO; 24 VDC; Ex i; XTR
<b>Technical Data</b>	
Number of digital outputs	2
Signal type	24 VDC
Output characteristic	High-side switching
Load type	Resistive; inductive; lamp load
Actuator connection	2-wire
Switching frequency (max.)	1 kHz
Actuator supply voltage	24 VDC
Supply voltage (field)	24 VDC (Ex i XTR power supply $U_o = \text{max. } 26.8 \text{ V}$ ); via power jumper contacts (power supply via blade contact; transmission via spring contact)
Current consumption – system supply (5 V)	7 mA
Data width (internal)	2 bits
Isolation	$U_m = 300 \text{ VAC}$ system/supply
Surrounding air temperature (operation)	$-40 \dots +70 \text{ }^\circ\text{C}$
Dimensions W x H x D	12 x 67.8 x 100 mm
<b>Explosion protection</b>	
Safety-relevant data (circuit)	$U_o = 26.8 \text{ V}$ ; $I_o = 99.91 \text{ mA}$ ; $P_o = 669.43 \text{ mW}$ ; Linear characteristic curve
Reactances Ex ia IIC	$L_o = 1.1 \text{ mH}$ ; $C_o = 0.092 \text{ } \mu\text{F}$
Reactances Ex ia IIB	$L_o = 12 \text{ mH}$ ; $C_o = 0.72 \text{ } \mu\text{F}$
Reactances Ex ia IIA	$L_o = 21 \text{ mH}$ ; $C_o = 2.37 \text{ } \mu\text{F}$
Reactances Ex ia I	$L_o = 30 \text{ mH}$ ; $C_o = 3.85 \text{ } \mu\text{F}$
Ex guideline	EN/IEC 60079-0, -7, -11
Approvals	CE; Marine; OrdLoc/HazLoc; ATEX/IECEx
Marking	Ⓔ ATEX/IECEx: II 3 (1) G Ex ec [ia Ga] IIC T4 Gc II (1) D [Ex ia Da] IIIC I (M1) [Ex ia Ma] I
Data sheet and further information, see:	<a href="http://wago.com/750-535/040-000">wago.com/750-535/040-000</a>

Reactances without accounting for the concurrence of capacitance ( $C_o$ ) and inductance ( $L_o$ )

## 4-Channel Analog Input; 0/4 ... 20 mA; NE43; Intrinsically Safe; Extreme



### Item Description

4-Channel Analog Input; 0/4 ... 20 mA; intrinsically safe

### Version

Extreme

### Item no.

750-486/040-000

### Order text

4AI; 0/4-20mA; Ex i; XTR

### Technical Data

Number of analog inputs	4
Signal type	0 mA ... 20 mA; 4 mA ... 20 mA; 3.6 ... 21 mA
Signal characteristic	Single-ended
Input resistance	< 200 Ω
Resolution	12 bits + sign bit
Conversion time	< 10 ms
Measuring error max., 25 °C	±0.1 % of the upper-range value
Temperature error max.	±0.01 %/K of the upper-range value
Supply voltage (field)	24 VDC (Ex i XTR power supply $U_o = \text{max. } 26.8 \text{ V}$ ); via power jumper contacts (power supply via blade contact; transmission via spring contact)
Current consumption – system supply (5 V)	45 mA
Transmitter supply	$U_v = 15 \text{ V}$ at 20 mA
Data width	4 x 16-bit data; 4 x 8-bit control/status (optional)
Isolation	$U_m = 300 \text{ VAC}$ system/supply
Surrounding air temperature (operation)	-40 ... +70 °C
Dimensions W x H x D	24 x 67.8 x 100 mm
<b>Explosion protection</b>	
Safety-relevant data (circuit)	$U_o = 26.8 \text{ V}$ ; $I_o = 92.72 \text{ mA}$ ; $P_o = 621.27 \text{ mW}$ ; Linear characteristic curve
Reactances Ex ia IIC	$L_o = 1.6 \text{ mH}$ ; $C_o = 0.082 \mu\text{F}$
Reactances Ex ia IIB	$L_o = 15 \text{ mH}$ ; $C_o = 0.71 \mu\text{F}$
Reactances Ex ia IIA	$L_o = 25 \text{ mH}$ ; $C_o = 2.36 \mu\text{F}$
Reactances Ex ia I	$L_o = 36 \text{ mH}$ ; $C_o = 3.84 \mu\text{F}$
Ex guideline	EN/IEC 60079-0, -7, -11
Approvals	CE; Marine; OrdLoc/HazLoc; ATEX/IECEX
Marking	Ⓢ ATEX/IECEX: II 3 (1) G Ex ec [ia Ga] IIC T4 Gc II (1) D [Ex ia Da] IIIC I (M1) [Ex ia Ma] I
Data sheet and further information, see:	<a href="http://wago.com/750-486/040-000">wago.com/750-486/040-000</a>

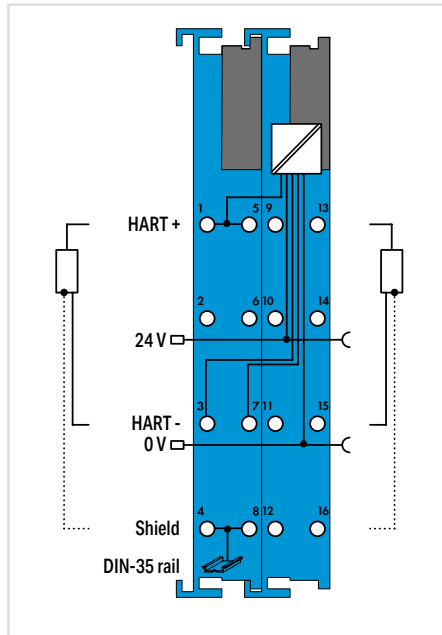
Reactances without accounting for the concurrence of capacitance ( $C_o$ ) and inductance ( $L_o$ )

6

„ Mini-WSB marker card and mounting accessories, see Section "Accessories and Tools"

„ Approvals and corresponding ratings, see page 526 or [www.wago.com](http://www.wago.com)

## 2-Channel Analog Input; 4 ... 20 mA HART; Intrinsically Safe; Extreme

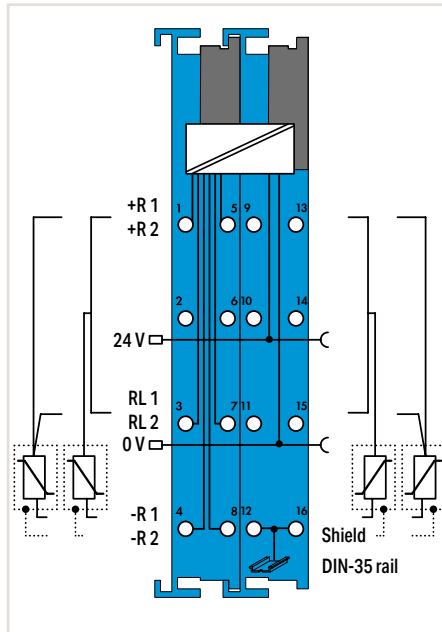


<b>Item Description</b>	2-Channel Analog Input; 4 ... 20 mA HART; intrinsically safe
<b>Version</b>	Extreme
<b>Item no.</b>	750-484/040-000
<b>Order text</b>	2AI; 4-20mA HART; Ex i; XTR
<b>Technical Data</b>	
Number of analog inputs	2
Signal type	4 ... 20 mA
Signal characteristic	Single-ended
Resolution	12 bits
Conversion time	10 ms
Measuring error max., 25 °C	0.2 % of the upper-range value
Temperature error max.	±0.01 %/K of the upper-range value
Supply voltage (field)	24 VDC (Ex i XTR power supply $U_o = \text{max. } 26.8 \text{ V}$ ); via power jumper contacts (power supply via blade contact; transmission via spring contact)
Current consumption – system supply (5 V)	25 mA
Transmitter supply	$U_v = 16.5 \text{ V}$ at 20 mA
Data width	2 x 2-byte data; 2 x 2-byte data + 2n x 4-byte data (n = number of dynamic variables); 2 x 2-byte data + 6-byte mailbox
Isolation	$U_m = 300 \text{ VAC}$ system/supply
Surrounding air temperature (operation)	-40 ... +70 °C
Dimensions W x H x D	24 x 67.8 x 100 mm
<b>Explosion protection</b>	
Safety-relevant data (circuit)	$U_o = 26.8 \text{ V}$ ; $I_o = 90.07 \text{ mA}$ ; $P_o = 603.5 \text{ mW}$ ; Linear characteristic curve
Reactances Ex ia IIC	$L_o = 1.8 \text{ mH}$ ; $C_o = 0.092 \text{ }\mu\text{F}$
Reactances Ex ia IIB	$L_o = 16 \text{ mH}$ ; $C_o = 0.72 \text{ }\mu\text{F}$
Reactances Ex ia IIA	$L_o = 27 \text{ mH}$ ; $C_o = 2.37 \text{ }\mu\text{F}$
Reactances Ex ia I	$L_o = 38 \text{ mH}$ ; $C_o = 3.85 \text{ }\mu\text{F}$
<b>Ex guideline</b>	EN/IEC 60079-0, -7, -11
<b>Approvals</b>	CE; Marine; OrdLoc/HazLoc; ATEX/IECEX
<b>Marking</b>	Ⓜ ATEX/IECEX: II 3 (1) G Ex ec [ia Ga] IIC T4 Gc II (1) D [Ex ia Da] IIIC I (M1) [Ex ia Ma] I
<b>Data sheet and further information, see:</b>	wago.com/750-484/040-000

In addition to the analog signal processing, this product offers the option of HART communication for parameterizing or recording side variables.

Reactances without accounting for the concurrence of capacitance ( $C_o$ ) and inductance ( $L_o$ )

## 2-Channel Analog Input; Resistance Measurement; Intrinsically Safe; Extreme



<b>Item Description</b>	2-Channel Analog Input; Resistance measurement; intrinsically safe
<b>Version</b>	Extreme
<b>Item no.</b>	750-481/040-000
<b>Order text</b>	2AI; RTD; Ex i; XTR
<b>Technical Data</b>	
Number of analog inputs	2
Signal type	Resistance thermometers: Pt100, Pt200, Pt500, Pt1000, Ni100, Ni120, Ni1000; Resistors: 1.2 k $\Omega$ , 5 k $\Omega$ ; Potentiometer setting: 0 ... 100 % (1.2 k $\Omega$ , 5 k $\Omega$ )
Sensor connection	2-wire; 3-wire
Temperature range	-200 ... + 850 °C (Pt); -60 ... +250 °C (Ni); -80 ... +320 °C (Ni120)
Resolution	0.1 °C; 0.1 $\Omega$ ; 0.0049 %
Conversion time	150 ... 500 ms (per channel)
Measuring error max., 25 °C	$\pm 0.2$ % of the upper-range value
Temperature error max.	$\pm 0.01$ %/K of the upper-range value
Supply voltage (field)	24 VDC (Ex i XTR power supply $U_o = \text{max. } 26.8 \text{ V}$ ); via power jumper contacts (power supply via blade contact; transmission via spring contact)
Current consumption – system supply (5 V)	25 mA
Data width	2 x 16-bit data; 2 x 8-bit control/status (optional)
Isolation	$U_m = 300 \text{ VAC}$ system/supply
Surrounding air temperature (operation)	-40 ... +70 °C
Dimensions W x H x D	24 x 67.8 x 100 mm
<b>Explosion protection</b>	
Safety-relevant data (circuit)	$U_o = 7.2 \text{ V}$ ; $I_o = 5.8 \text{ mA}$ ; $P_o = 10.5 \text{ mW}$ ; Linear characteristic curve
Reactances Ex ia IIC	$L_o = 100 \text{ mH}$ ; $C_o = 13.5 \mu\text{F}$
Reactances Ex ia IIB	$L_o = 100 \text{ mH}$ ; $C_o = 240 \mu\text{F}$
Reactances Ex ia IIA	$L_o = 100 \text{ mH}$ ; $C_o = 1000 \mu\text{F}$
Reactances Ex ia I	$L_o = 100 \text{ mH}$ ; $C_o = 1000 \mu\text{F}$
<b>Ex guideline</b>	EN/IEC 60079-0, -7, -11
<b>Approvals</b>	CE; Marine; OrdLoc/HazLoc; ATEX/IECEX
<b>Marking</b>	Ⓔ ATEX/IECEX: II 3 (1) G Ex ec [ia Ga] IIC T4 Gc II (1) D [Ex ia Da] IIIC I (M1) [Ex ia Ma] I
<b>Data sheet and further information, see:</b>	<a href="http://wago.com/750-481/040-000">wago.com/750-481/040-000</a>

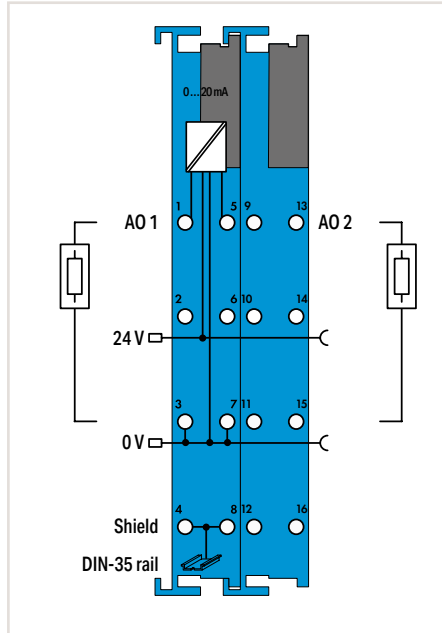
Reactances without accounting for the concurrence of capacitance ( $C_o$ ) and inductance ( $L_o$ )

„ Mini-WSB marker card and mounting accessories, see Section "Accessories and Tools"

„ Approvals and corresponding ratings, see page 526 or [www.wago.com](http://www.wago.com)



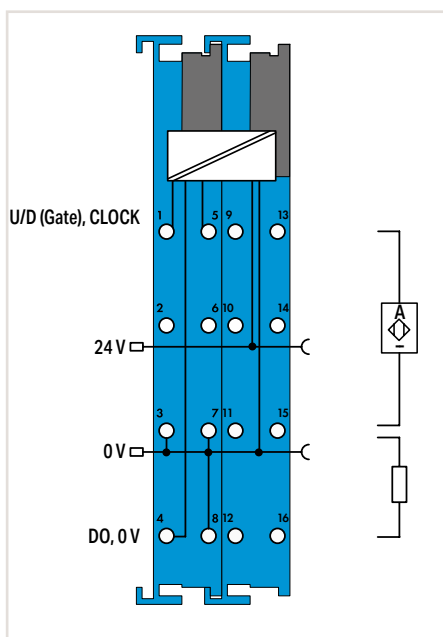
## 2-Channel Analog Output; 0 ... 20 mA; Intrinsically Safe; Extreme



<b>Item Description</b>	2-Channel Analog Output; 0 ... 20 mA; intrinsically safe
<b>Version</b>	Extreme
<b>Item no.</b>	750-585/040-000
<b>Order text</b>	2AO; 0-20mA; Ex i; XTR
<b>Technical Data</b>	
Number of analog outputs	2
Signal type	0 ... 20 mA
Signal characteristic	Single-ended
Load impedance	< 500 Ω
Resolution	12 bits
Conversion time	< 2 ms
Output error max., 25 °C	±0.2 % of the upper-range value
Temperature error max.	±0.01 %/K of the upper-range value
Supply voltage (field)	24 VDC (Ex i XTR power supply $U_o = \text{max. } 26.8 \text{ V}$ ); via power jumper contacts (power supply via blade contact; transmission via spring contact)
Current consumption – system supply (5 V)	21 mA
Data width	2 x 16-bit data
Isolation	$U_m = 300 \text{ VAC}$ system/supply
Surrounding air temperature (operation)	-40 ... +70 °C
Dimensions W x H x D	24 x 67.8 x 100 mm
<b>Explosion protection</b>	
Safety-relevant data (circuit)	$U_o = 26.8 \text{ V}$ ; $I_o = 56.4 \text{ mA}$ ; $P_o = 378 \text{ mW}$ ; Linear characteristic curve
Reactances Ex ia IIC	$L_o = 8.2 \text{ mH}$ ; $C_o = 0.092 \mu\text{F}$
Reactances Ex ia IIB	$L_o = 46 \text{ mH}$ ; $C_o = 0.72 \mu\text{F}$
Reactances Ex ia IIA	$L_o = 76 \text{ mH}$ ; $C_o = 2.37 \mu\text{F}$
Reactances Ex ia I	$L_o = 100 \text{ mH}$ ; $C_o = 3.85 \mu\text{F}$
Ex guideline	EN/IEC 60079-0, -7, -11
Approvals	CE; Marine; OrdLoc/HazLoc; ATEX/IECEX
Marking	Ⓔ ATEX/IECEX: II 3 (1) G Ex ec [ia Ga] IIC T4 Gc II (1) D [Ex ia Da] IIIC I (M1) [Ex ia Ma] I
Data sheet and further information, see:	<a href="http://wago.com/750-585/040-000">wago.com/750-585/040-000</a>

Reactances without accounting for the concurrence of capacitance ( $C_o$ ) and inductance ( $L_o$ )

## Up/Down Counter; Intrinsically Safe; Extreme



<b>Item Description</b>	Up/Down Counter; intrinsically safe
<b>Version</b>	Extreme
<b>Item no.</b>	750-633/040-000
<b>Order text</b>	Up/Down Counter; Ex i; XTR
<b>Technical Data</b>	
Number of counters	1
No. of outputs	1
Sensor supply $U_v$	8.2 VDC
Input filter	10 $\mu$ s
Switching frequency	20 Hz ... 50 kHz
Counter depth	32 bits
Output voltage	24 VDC
Supply voltage (field)	24 VDC (Ex i XTR power supply $U_o = \text{max. } 26.8 \text{ V}$ ); via power jumper contacts (power supply via blade contact; transmission via spring contact)
Current consumption – system supply (5 V)	25 mA
Data width	1 x 32-bit data, 1 x 8-bit status/diagnostics
Isolation	$U_m = 300 \text{ VAC}$ system/supply
Surrounding air temperature (operation)	-40 ... +70 °C
Dimensions W x H x D	24 x 67.8 x 100 mm
<b>Explosion protection</b>	
Safety data – input	$U_o = 12 \text{ V}$ ; $I_o = 13.3 \text{ mA}$ ; $P_o = 40.4 \text{ mW}$ ; Linear characteristic curve
Input reactances Ex ia IIC	$L_o = 100 \text{ mH}$ ; $C_o = 1.41 \mu\text{F}$
Input reactances Ex ia IIB	$L_o = 100 \text{ mH}$ ; $C_o = 9 \mu\text{F}$
Input reactances Ex ia IIA	$L_o = 100 \text{ mH}$ ; $C_o = 36 \mu\text{F}$
Input reactances Ex ia I	$L_o = 100 \text{ mH}$ ; $C_o = 35 \mu\text{F}$
Safety data – output	$U_o = 26.8 \text{ V}$ ; $I_o = 96.69 \text{ mA}$ ; $P_o = 674.83 \text{ mW}$ ; Linear characteristic curve
Output reactances Ex ia IIC	$L_o = 1.3 \text{ mH}$ ; $C_o = 0.091 \mu\text{F}$
Output reactances Ex ia IIB	$L_o = 13 \text{ mH}$ ; $C_o = 0.719 \mu\text{F}$
Output reactances Ex ia IIA	$L_o = 23 \text{ mH}$ ; $C_o = 2.369 \mu\text{F}$
Output reactances Ex ia I	$L_o = 33 \text{ mH}$ ; $C_o = 3.849 \mu\text{F}$
<b>Ex guideline</b>	EN/IEC 60079-0, -7, -11
<b>Approvals</b>	CE; Marine; OrdLoc/HazLoc; ATEX/IECEX
<b>Marking</b>	Ⓒ ATEX/IECEX: II 3 (1) G Ex ec [ia Ga] IIC T4 Gc II (1) D [Ex ia Da] IIIC I (M1) [Ex ia Ma] I
<b>Data sheet and further information, see:</b>	<a href="http://wago.com/750-633/040-000">wago.com/750-633/040-000</a>

Reactances without accounting for the concurrence of capacitance ( $C_o$ ) and inductance ( $L_o$ )

„ Mini-WSB marker card and mounting accessories, see Section "Accessories and Tools"

„ Approvals and corresponding ratings, see page 527 or [www.wago.com](http://www.wago.com)

6



# Industrial Switches

## Industrial Switches

- Copper cables
- Fiber optic cables
- Ring redundancy

# Industrial Switches Contents

	Page
General Product Information	396
Interfaces and Types	397
Variants	397
Configuration, Diagnostics and Performance	398
Security	399
Redundancy	400
Item Number Key	401
Standards and Rated Conditions	401
Approvals	401



	Managed	No. of Ports	Medium	Item No.	
Industrial Switches		5	100BASE-TX	852-101	402
		8	100BASE-TX	852-102	402
		8/2	100BASE-TX/ 100BASE-FX	852-103	403
		8	1000BASE-T	852-1102	404
		16	1000BASE-T	852-1106	405
Industrial Managed Switches	x	8/2	100BASE-TX/ 100BASE-FX/ 1000BASE-SX/LX	852-303	406
	x	8/4	1000BASE-T/ 1000BASE-SX/LX	852-1305	406
	x	8/4 8 PoE+	1000BASE-T/ 1000BASE-SX/LX	852-1505	407
Industrial Eco Switches		5	100BASE-TX	852-111	408
		8	100BASE-TX	852-112	408
		5	1000BASE-T	852-1111	409
		8	1000BASE-T	852-1112	409
		5 4 PoE+	1000BASE-T	852-1411	410
		5/2 4 PoE+	1000BASE-T/ 1000BASE-SX/LX	852-1417	410
Accessories					
SFP Modules, Mounting Adapters					412

## Industrial Switches

### General Product Information

#### Always the Right Solution

WAGO's range of switches ensures the scalability of your ETHERNET network infrastructure, while providing outstanding electrical and mechanical characteristics. These robust switches are designed for industrial use and are fully compliant with IEEE 802.3, IEEE 802.3u and IEEE 802.3ab.

#### Combinable with Fiber Optic Cables

ETHERNET via fiber optic cables offers a multitude of advantages for industrial applications.

High immunity to interference, electrical isolation and long ranges up to 80 km are extremely beneficial characteristics – and these benefits are a perfect fit with IT.

#### Scaled Offering

Unmanaged and managed switches in various designs are available for high-end applications. Our Eco Switches are ideal for cost-sensitive applications that do not require technical features such as redundancy. They are ideal for small- to medium-sized networks.

#### Modular and Expandable

Exchangeable SPF modules adapt WAGO's switches to various fiber optic cables (FOC) and the associated required distances and fibers.

There are SFP modules for multimode and single-mode fiber optic cables for ranges up to 80 km. With the exact combination of copper and fiber optic cables, you are prepared for a multitude of requirements.

#### Web-Based Management

WAGO's fully managed switches have integrated Web-based management. Any Web browser can be used to configure the switch.

#### Integrated Function Monitoring

For monitoring and error reporting, the managed switch has configurable functions such as e-mail alarm and SNMP traps. In addition, all switches (except for Eco versions) can monitor individual ports or the power supply via potential-free alarm contact. A DIP switch is used to configure this function.

#### Full Bandwidth on All Ports

The switches' internal bandwidth is designed so that all ports can communicate simultaneously – in full duplex without restrictions.

#### Security

Managed switches have built-in security features, such as:

- Authentication
- Access control lists
- DHCP snooping
- Port security

#### Data Transmission

Managed switches provide configuration options for data transfer, such as:

- VLAN
- IGMP snooping
- IP-based VLAN
- MAC-based VLAN

#### Availability, Redundancy

Select industrial switches have several options to build redundant network structures and guarantee secure communication – even when connections are faulty:

- Rapid Spanning Tree per IEEE 802.1w – compatible with IT standards
- Jet Ring – a simple ring protocol with switching time < 300 ms
- Xpress Ring – fast ring protocol with switching time < 20 ms
- ERPSv2 per ITU-T standard with switching time < 50 ms

In addition to communication link redundancy, a redundant power supply – which can also be monitored using an alarm relay – is integrated into the switches. If the power supply fails, communication is not interrupted.

#### Different Operating Modes

The unmanaged switches are ideal for direct plug-and-play use. Managed switches are available for applications where IP filtering or further interpretation of telegrams is required for the application.

#### Configurable Performance

Managed switches offer performance control features, such as:

- Storm control
- Bandwidth control
- Auto-provisioning
- Link aggregation

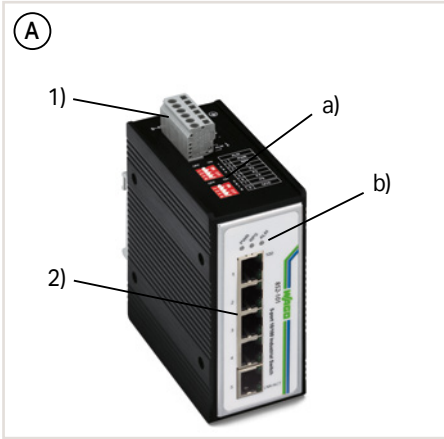
#### Bit-Based Configuration and Diagnostics

Modbus® can be used to diagnose managed switches. Configuration and diagnostics are also possible with standardized protocols such as SNMP.

#### Advantages:

- Adaptable to different transmission media
- Automatically adapts to
  - Speed (auto-negotiation)
  - Wiring (auto-crossover, MDI/MDIX)
- Optional redundancy
- Wide supply voltage range

# Industrial Switches Interfaces and Types



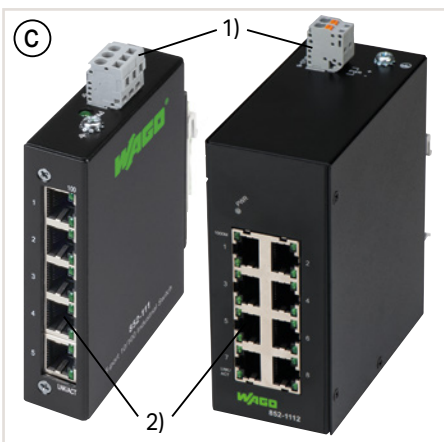
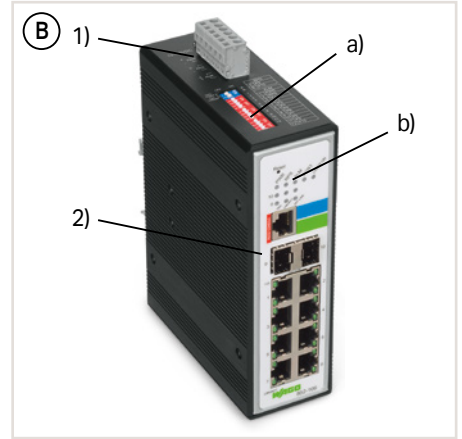
Power supply (1)  
Technologically related differences on the connection level (2)

### Housing Design (A)

- DIP switch for configuration (a)
- Diagnostic LEDs (b)
- W x H\* x D (mm) 50 x 120 x 105

### Housing Design (B)

- DIP switch for configuration (a)
- Diagnostic LEDs (b)
- W x H\* x D (mm) 50 x 120 x 162

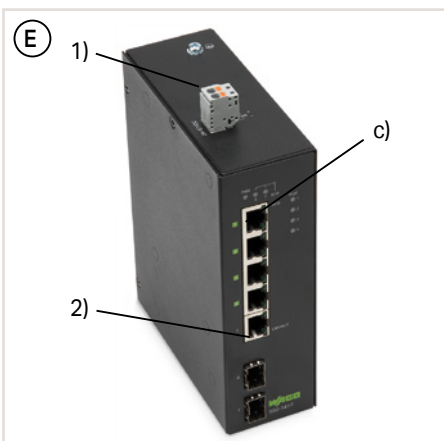
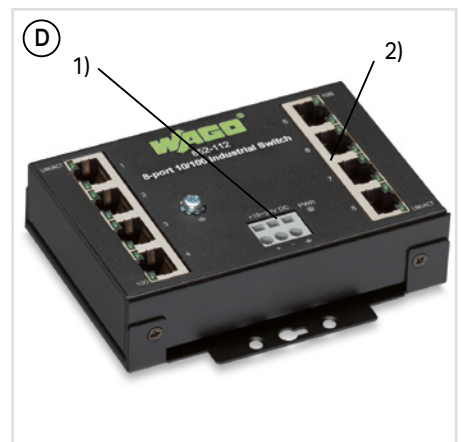


### Housing Design Eco (C)

- W x H\* x D (mm) 23.4 x 73.8 x 109.2 or 46 x 99.6 x 116
- DIN-35 rail
- wall-mount (852-111, 852-1111)

### Housing Design Eco (D)

- W x H\* x D (mm) 109.2 x 23.4 x 73.8
- DIN-35 rail or wall-mount



### Housing Design PoE+ (E)

- Power over Ethernet (PoE+) Ports (c)
- W x H\* x D (mm) 50 x 120 x 160

### Housing Design (F)

- SFP module for connecting fiber optic cables
- LC connector
- W x H x D (mm) 13.4 x 13.3 x 56.6

\*Height from upper edge of DIN-rail



## Variants



### Extended Temperature Range

Industrial automation technology is typically operated in temperatures ranging from 0°C to 55°C. However, there are applications that require an extended temperature range. Nearly all switches and SFP modules are available for an extended temperature range of -40°C to +70°C.

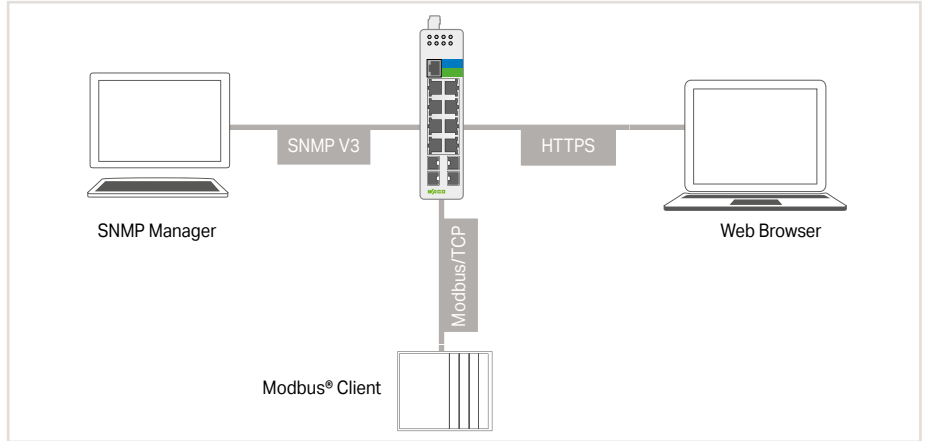
# Industrial Switches

## Configuration, Diagnostics and Performance

### Configuration and Diagnostics

Several options:

- Configuration via Web-based management
- Configuration via command line (SSH, Telnet, RS-232)
- Network management via SNMP v1, v2c, v3
- Support of MIB standards (Management Information Base)
- Diagnostics via Modbus TCP: Comprehensive diagnostic data available for easy diagnostics via Modbus®



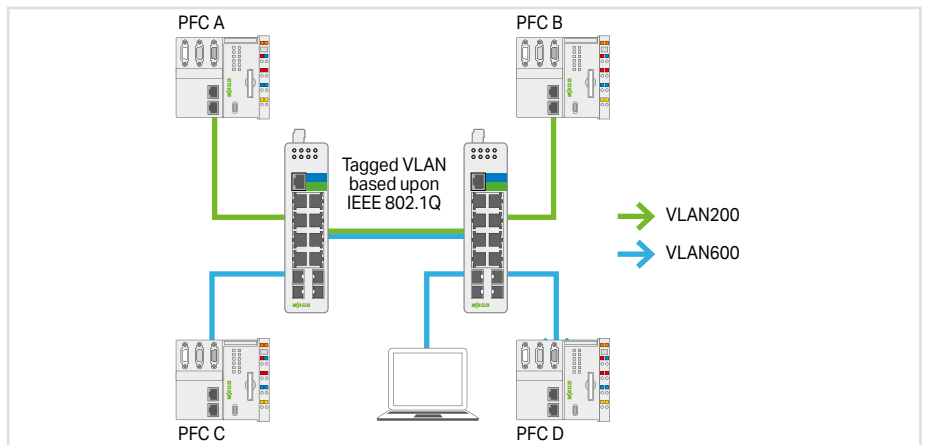
Configuration Interfaces

### Logical Network Disconnection

VLAN (e.g., per IEEE 802.1Q)

Segmentation into virtual networks:

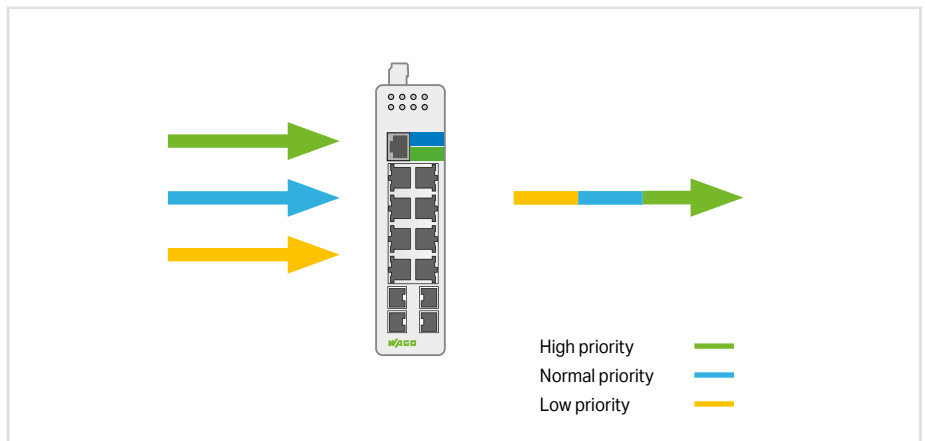
- Broadcast limitation
- Security improvement
- Data flow prioritization
- Subdivision of machines and office networks, for example



### Traffic Prioritization and Limitation

- Faster transfer of important data packets through the switch
- Prioritization of data packets per IEEE 802.1Q
- Limitation of the bandwidth or number of packets per unit of time per port
- Increase in data transmission quality

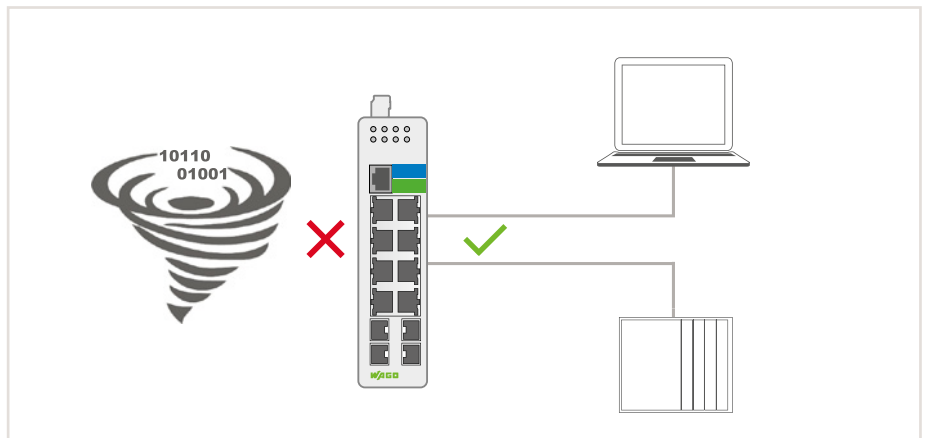
7



QoS

### Mastering Data Traffic

- Stopping broadcast storms
- Ensuring network availability
- Limiting broadcast and multicast data flows (packets/time)



Storm Control



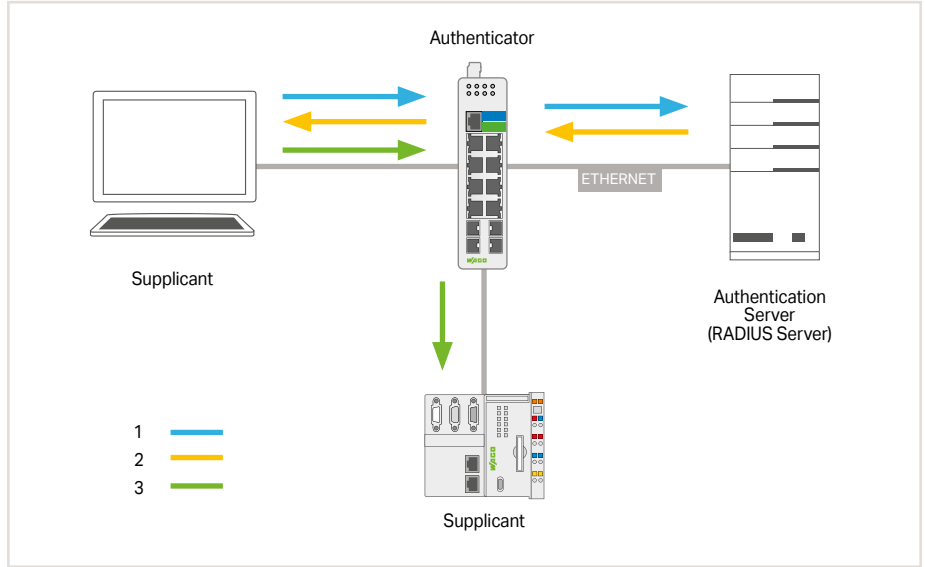
# Industrial Switches Security

## Authentication IEEE 802.1X

Secure authentication and authorization in ETHERNET networks (locally on the switch or via RADIUS server)

Process:

- Authentication of a subscriber is performed by the authenticator.
- The authenticator checks the authentication information of the subscriber (supplicant) with an authentication server.

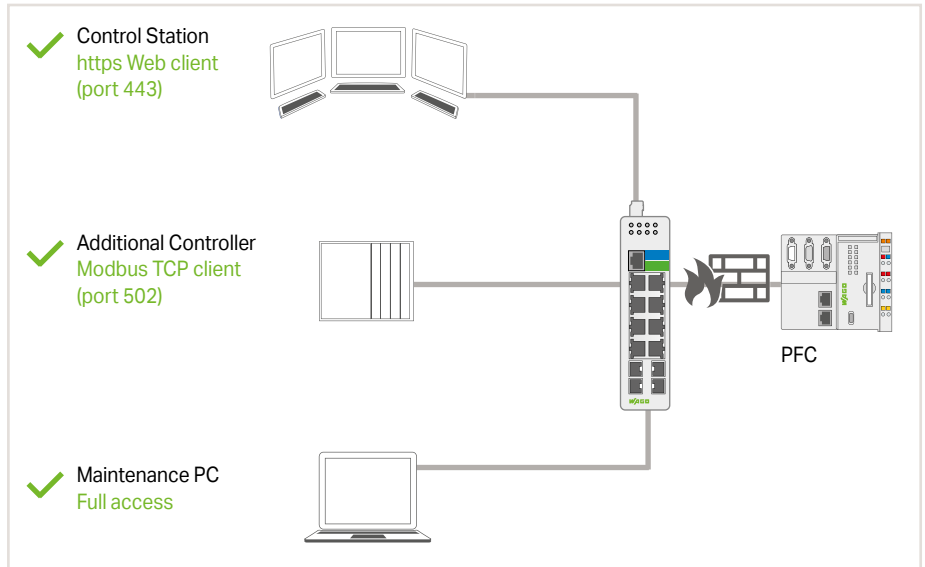


IEEE 802.1X

## Firewall – Access Control List

Filtering data packets due to:

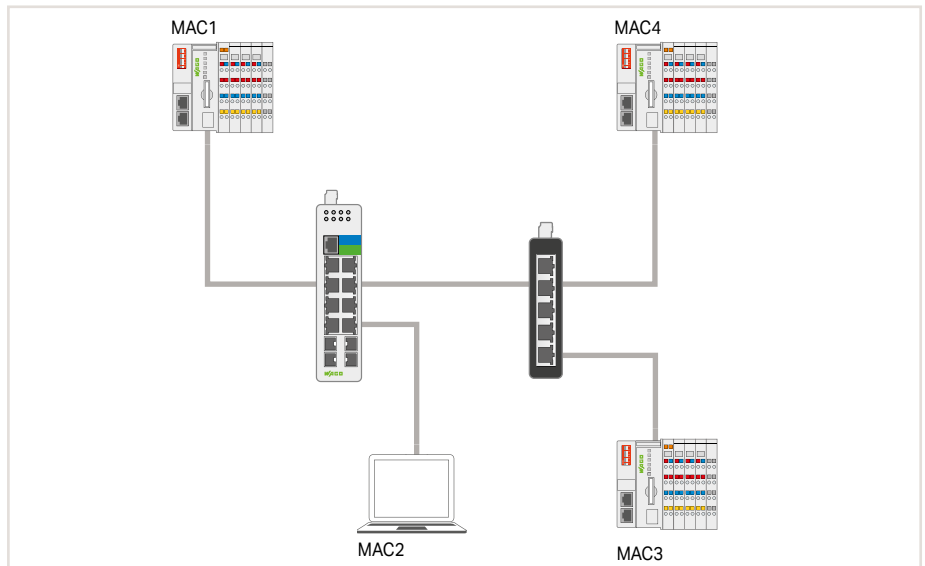
- a source MAC or source IP address
- a destination MAC or destination IP address
- a range of MAC or IP addresses
- UDP/TCP source or destination ports



Firewall

## Port Security

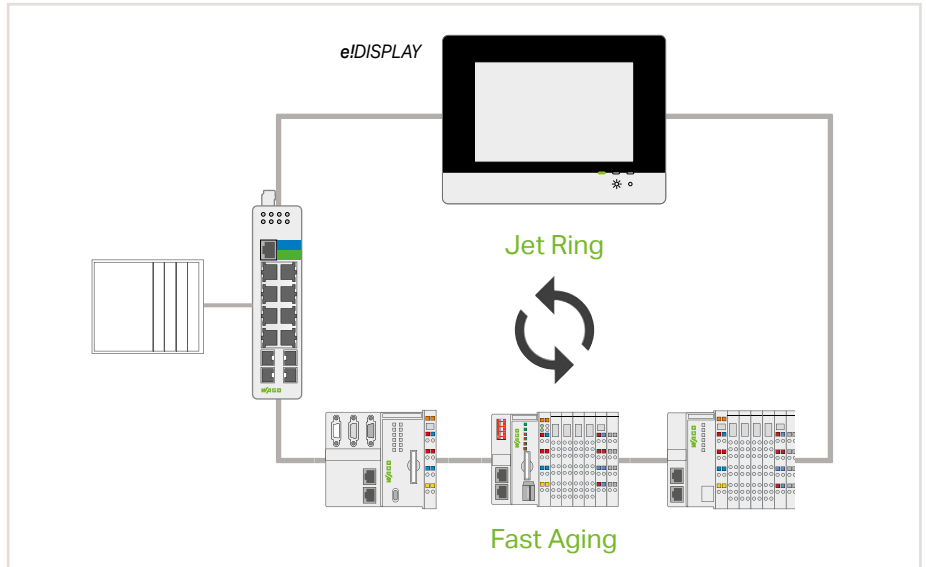
- Dynamically learns MAC addresses per port
- Limitation of MAC addresses per port
- MAC-based white/blacklist per port



# Industrial Switches Redundancy

## Jet Ring

- Typical switching time < ~ 300 ms (depends on the application)
- Extremely easy configuration
- Up to 20 participants (Fast Aging) in a Jet Ring



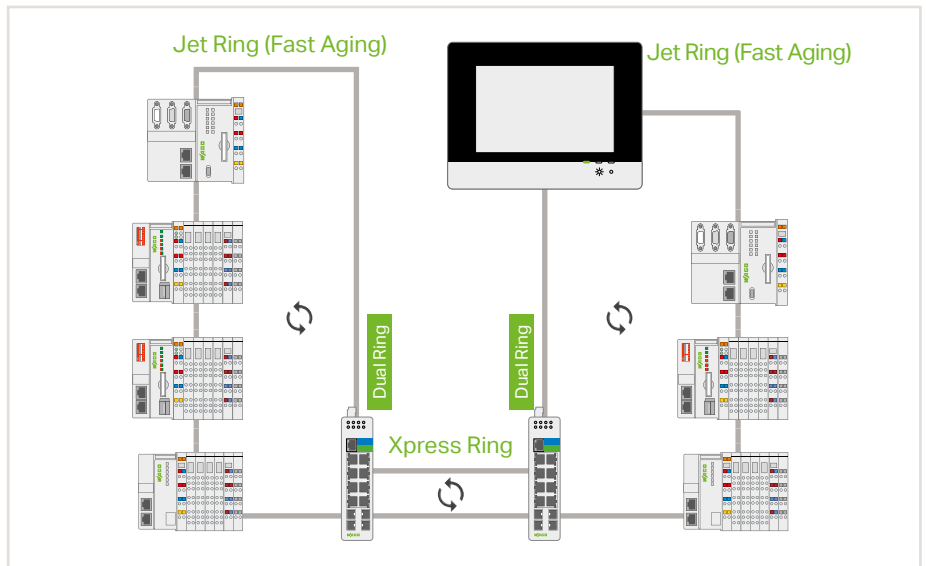
Jet Ring

## Xpress Ring

- Switching time < 20 ms
- Easy configuration
- Up to 200 switches in one Xpress Ring
- 2 Xpress Rings per switch

## Dual Ring

- Combination of both redundancy types
- 1 Jet Ring and 1 Xpress Ring per switch or 2 Xpress Rings per switch



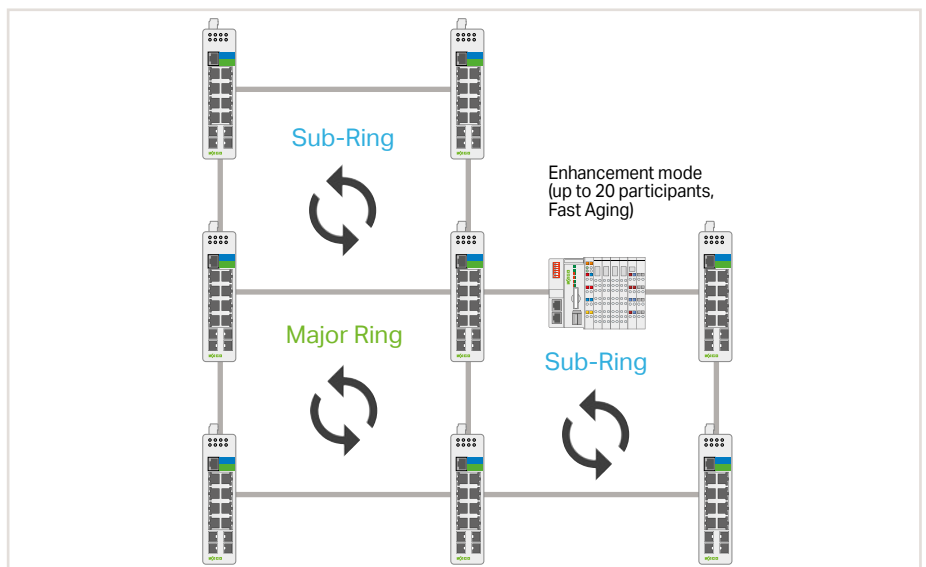
Xpress Ring and Dual Ring

## ERPS: ETHERNET Ring Protection Switching

- Standardized and open technology
- Switching time < 50 ms
- Nested topologies with up to six rings per switch
- Realization of a one-fault tolerance (SPOF – Single Point of Failure)

## ERPS – Enhancement Mode

- WAGO devices with an integrated switch and Fast Aging configuration
- Typical switching time < ~ 300 ms (depends on the application)

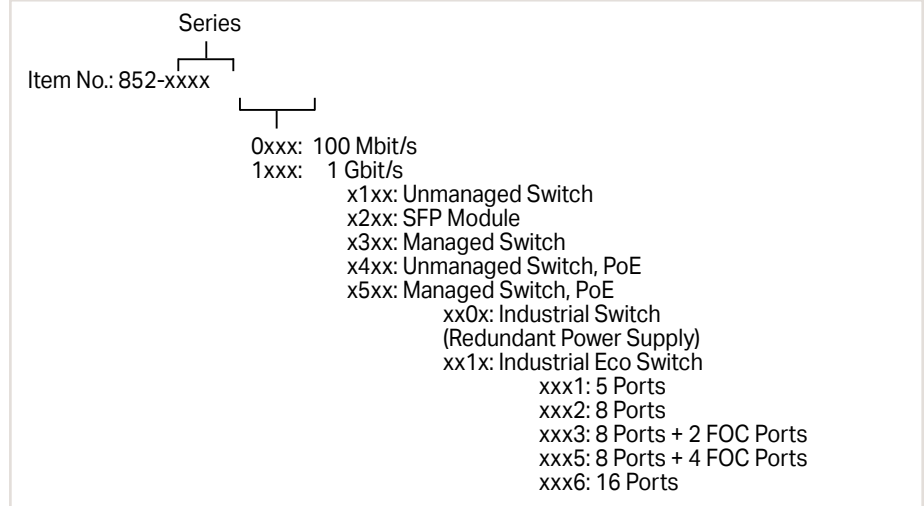


ERPS V2

## Industrial Switches

### Item Number Key

Explanation of an item number key's components



## Standards and Rated Conditions

### General Specifications

Packet throughput per port	10 Mbps port: 14,880 packages per second (pps) 100 Mbps port: 148,800 packages per second (pps) 1000 Mbps port: 1,488,000 packages per second (pps)
Surrounding air temperature (operation)	-40 ... +70 °C
Surrounding air temperature (storage)	-40 ... +80 °C
Relative humidity max.	95 % (non condensing)
Vibration resistance	4g per IEC 60068-2-6
Shock resistance	15g per IEC 60068-2-27
EMC immunity to interference	EN 61000-6-2
EMC emission of interference	EN 61000-6-4
Protection type	IP30
Mounting type	On DIN-35 rail, Eco version also for wall-mount
Mounting position	Any

## Approvals

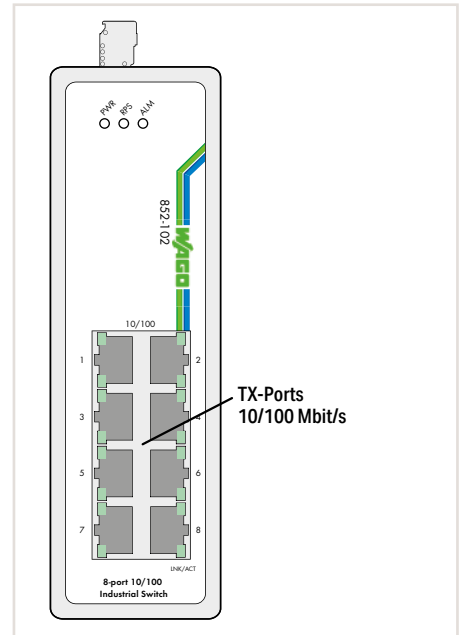
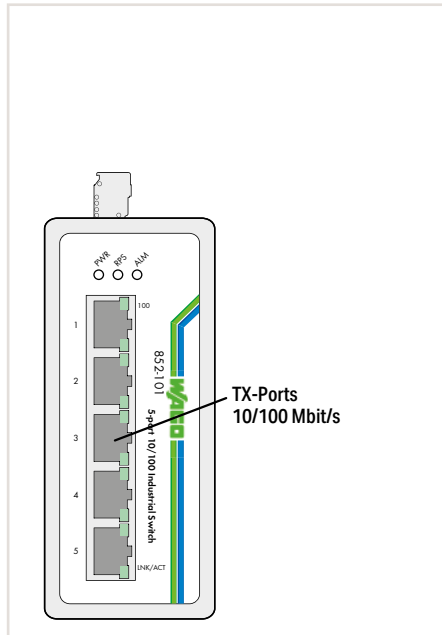
For approvals overview (item comparison), see Section 11 (Technical Section) or visit [www.wago.com](http://www.wago.com).



# Industrial Switch



Figure: 852-101

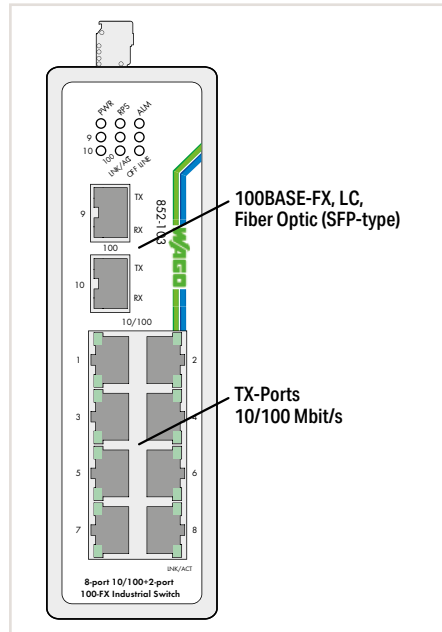


Item Description	Industrial Switch; 5-port 100BASE-TX 852-101	Industrial Switch; 8-port 100BASE-TX 852-102
Item No.	852-101	852-102
Order Text	Industrial Switch; 5Port	Industrial Switch; 8Port
<b>Technical Data</b>		
Switching mode	Store-and-forward, non-blocking	Store-and-forward, non-blocking
Number of copper ports	5 x 100BASE-TX	8 x 100BASE-TX
Communication standards	IEEE 802.3 10BASE-T; IEEE 802.3u 100BASE-TX; IEEE 802.3x Flow Control	IEEE 802.3 10BASE-T; IEEE 802.3u 100BASE-TX; IEEE 802.3x Flow Control
Redundancy functions	Redundant DC power supply	Redundant DC power supply
Configuration	DIP switch for signal contact	DIP switch for signal contact
Diagnostics	Signal contact	Signal contact
MAC table (large)	2000 addresses	2000 addresses
Jumbo frame size	1536 bytes	1516 bytes
Supply voltage	9 ... 48 VDC	9 ... 48 VDC
Power consumption (max.)	4 W	5.3 W
ESD (contact/air discharge)	8 KV / 15 KV	8 KV / 15 KV
Connection technology (communication)	5 x RJ-45	8 x RJ-45
Surrounding air temperature (operation)	-40 ... +70 °C	-40 ... +70 °C
Dimensions W x H x D	50 x 120 x 105 mm	50 x 120 x 162 mm
Approvals	CE; UL; OrdLoc	CE; UL; OrdLoc
Data sheet and further information, see:	<a href="http://wago.com/852-101">wago.com/852-101</a>	<a href="http://wago.com/852-102">wago.com/852-102</a>

7

- „ SFP Modules, see page 412
- „ Passive ETHERNET components, see Section "Accessories and Tools"
- „ Approvals and corresponding ratings, see page 529 or [www.wago.com](http://www.wago.com)

## Industrial Switch



### Item Description

Item No.

Order Text

Industrial Switch; 8-port 100BASE-TX;  
2-slot 100BASE-FX

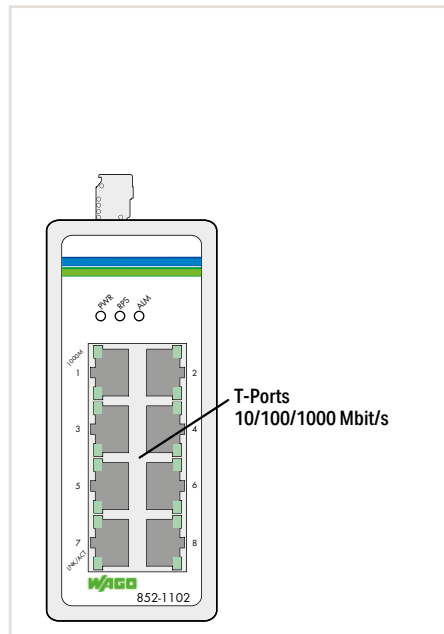
852-103

Industrial Switch; 8Port; 2-Slot 100BASE-FX

### Technical Data

Switching mode	Store-and-forward, non-blocking
Number of copper ports	8 x 100BASE-TX
Number of FOC ports	2 x 100BASE-FX
Communication standards	IEEE 802.3 10BASE-T; IEEE 802.3u 100BASE-TX/FX; IEEE 802.3x Flow Control
Redundancy functions	Redundant DC power supply
Configuration	DIP switch for signal contact
Diagnostics	Signal contact
MAC table (large)	2000 addresses
Jumbo frame size	1536 bytes
Supply voltage	9 ... 48 VDC
Power consumption (max.)	6.1 W
ESD (contact/air discharge)	8 KV / 15 KV
Connection technology (communication)	8 x RJ-45; 2 x SFP
Surrounding air temperature (operation)	-40 ... +70 °C
Dimensions W x H x D	50 x 120 x 162 mm
Approvals	CE; RoHS; OrdLoc
Data sheet and further information, see:	<a href="http://wago.com/852-103">wago.com/852-103</a>

## Industrial Switch



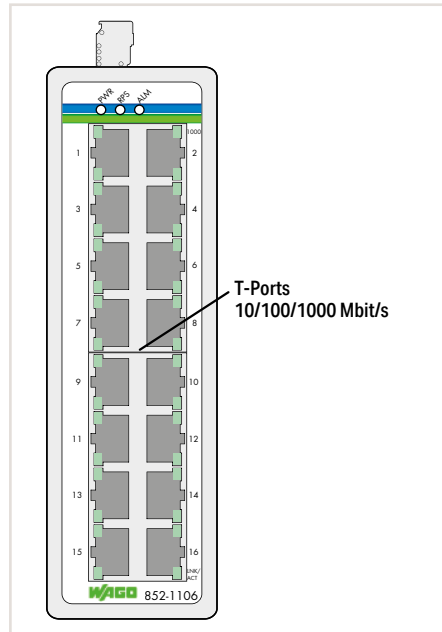
Item Description	Industrial Switch; 8-port 1000BASE-T
Item No.	852-1102
Order Text	Industrial Switch; 8-Port Gb
<b>Technical Data</b>	
Switching mode	Store-and-forward, non-blocking
Number of copper ports	8 x 1000BASE-T
Communication standards	IEEE 802.3 10BASE-T; IEEE 802.3u 100BASE-TX; IEEE 802.3ab 1000BASE-T; IEEE 802.3x Flow Control; IEEE 802.3az Energy Efficient Ethernet; IEEE 802.1p Prioritization
Redundancy functions	Redundant DC power supply
Configuration	DIP switch for signal contact
Diagnostics	Signal contact
MAC table (large)	8000 addresses
Jumbo frame size	9 kB
Supply voltage	9 ... 57 VDC
Power consumption (max.)	6 W
ESD (contact/air discharge)	8 KV / 15 KV
Connection technology (communication)	8 x RJ-45
Surrounding air temperature (operation)	-40 ... +70 °C
Dimensions W x H x D	50 x 120 x 105 mm
Approvals	CE; ®= OrdLoc*
Data sheet and further information, see:	<a href="http://wago.com/852-1102">wago.com/852-1102</a>

\*pending

„ Passive ETHERNET components,  
see Section "Accessories and Tools"

„ Approvals and corresponding ratings,  
see page 529 or [www.wago.com](http://www.wago.com)

## Industrial Switch



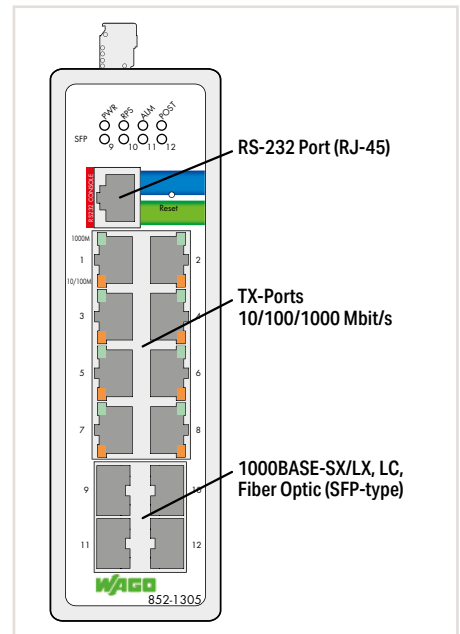
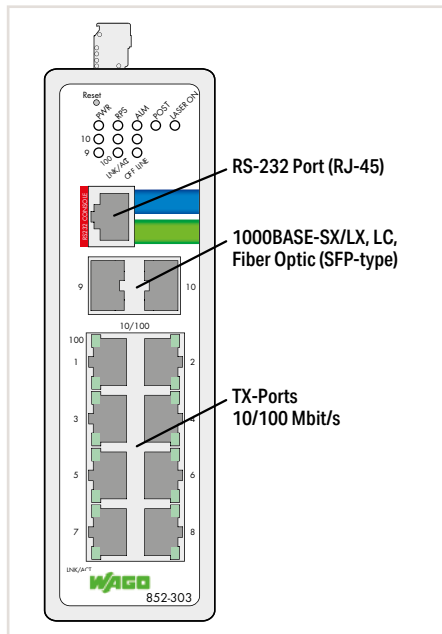
<b>Item Description</b>	<b>Industrial Switch; 16-port 1000BASE-T</b>
<b>Item No.</b>	<b>852-1106</b>
<b>Order Text</b>	Industrial Switch; 16-Port Gb
<b>Technical Data</b>	
Switching mode	Store-and-forward, non-blocking
Number of copper ports	16 x 1000BASE-T
Communication standards	IEEE 802.3 10BASE-T; IEEE 802.3u 100BASE-TX/FX; IEEE 802.3ab 1000BASE-T; IEEE 802.3x Flow Control; IEEE 802.3az Energy Efficient Ethernet; IEEE 802.1p Prioritization
Redundancy functions	Redundant DC power supply
Configuration	DIP switch for signal contact
Diagnostics	Signal contact
MAC table (large)	8000 addresses
Jumbo frame size	10 KB
Supply voltage	12 ... 60 VDC
Power consumption (max.)	12 W
Connection technology (communication)	16 x RJ-45
Surrounding air temperature (operation)	-40 ... +70 °C
Dimensions W x H x D	50 x 120 x 162 mm
Approvals	CE; OrdLoc*
Data sheet and further information, see:	<a href="http://wago.com/852-1106">wago.com/852-1106</a>

\*pending

# Industrial Managed Switch



Figure: 852-303



Item Description	Industrial Managed Switch; 8-port 100BASE-TX; 2-slot 1000BASE-SX/LX 852-303	Industrial Managed Switch; 8-port 1000BASE-T; 4-slot 1000BASE-SX/LX 852-1305
Item No.	852-303	852-1305
Order Text	Industrial Managed Switch; 8Port; 2-Slot 1000BASE-SX/LX	Industrial Managed Switch; 8-Port Gb; 4-Slot 1000BASE-SX/LX
<b>Technical Data</b>		
Switching mode	Store-and-forward, non-blocking	Store-and-forward, non-blocking
Number of copper ports	8 x 100BASE-TX	8 x 1000BASE-T
Number of FOC ports	2 x 100BASE-FX / 1000BASE-SX/LX	4 x 1000BASE-SX/LX
Communication standards	IEEE 802.3 10BASE-T; IEEE 802.3u 100BASE-TX/FX; IEEE 802.3z 1000BASE-SX/LX; IEEE 802.3x Flow Control; IEEE 802.1w Rapid Spanning Tree Protocol (RSTP); IEEE 802.1q VLAN Tagging; IEEE 802.1ab Link Layer Discovery Protocol (LLDP); IEEE 802.1p Prioritization; IEEE 802.1x Port Authentication; ITU-T G8032v1/v2 Ethernet Ring Protection Switching (ERPS)	IEEE 802.3 10BASE-T; IEEE 802.3u 100BASE-TX; IEEE 802.3ab 1000BASE-T; IEEE 802.3z 1000BASE-SX/LX; IEEE 802.3x Flow Control; IEEE 802.1w Rapid Spanning Tree Protocol (RSTP); IEEE 802.1q VLAN Tagging; IEEE 802.1ab Link Layer Discovery Protocol (LLDP); IEEE 802.1p Prioritization; IEEE 802.1x Port Authentication; ITU-T G8032v1/v2 Ethernet Ring Protection Switching (ERPS)
Redundancy functions	Redundant DC power supply; STP; RSTP; MSTP; Jet Ring < 300 ms; Xpress Ring < 20 ms; Dual Homing < 20 ms; Dual Ring; ERPSv2 < 50 ms; LCAP	Redundant DC power supply; STP; RSTP; MSTP; Jet Ring < 300 ms; Xpress Ring < 20 ms; Dual Homing < 20 ms; Dual Ring; ERPSv2 < 50 ms; LCAP
Configuration	DIP switch for signal contact; Web-Based-Management; Command Line Interface; SNMPv1/v2c/v3	DIP switch for signal contact; Web-Based-Management; Command Line Interface; SNMPv1/v2c/v3
Diagnostics	Signal contact; Modbus TCP; Port status; Port statistics; Port load; Traffic monitor; SFP information; Syslog; Mail alarm; SNMP traps	Signal contact; Modbus TCP; Port status; Port statistics; Port load; Traffic monitor; SFP information; Syslog; Mail alarm; SNMP traps
MAC table (large)	16,000 addresses	16,000 addresses
Jumbo frame size	10 KB	10 KB
Supply voltage	12 ... 60 VDC	12 ... 60 VDC
Power consumption (max.)	12 W	12 W
ESD (contact/air discharge)	8 KV / 15 KV	8 KV / 15 KV
Connection technology (communication)	8 x RJ-45; 2 x SFP; 1 x RJ-45 (RS-232)	8 x RJ-45; 4 x SFP; 1 x RJ-45 (RS-232)
Communication standards	IEEE802.3x (in full duplex mode)	IEEE802.3x (in full duplex mode)
Surrounding air temperature (operation)	-40 ... +70 °C	-40 ... +70 °C
Dimensions W x H x D	50 x 120 x 162 mm	50 x 120 x 162 mm
Approvals	CE; DNV GL; OrdLoc*	CE; DNV GL; DNV; OrdLoc*
Data sheet and further information, see:	wago.com/852-303	wago.com/852-1305

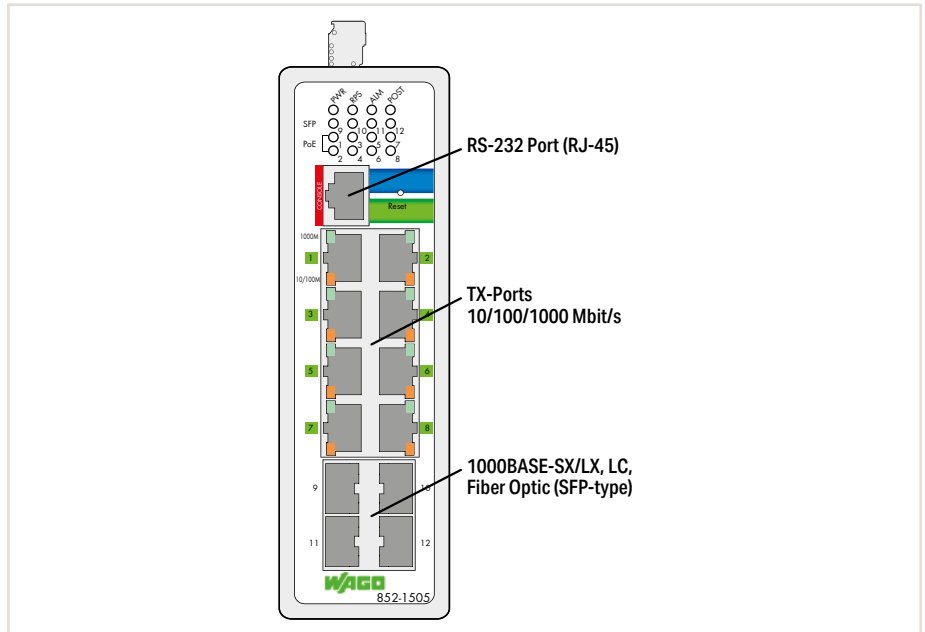
\*pending

\*pending

\* SFP Modules, see page 412



# Industrial Managed Switch



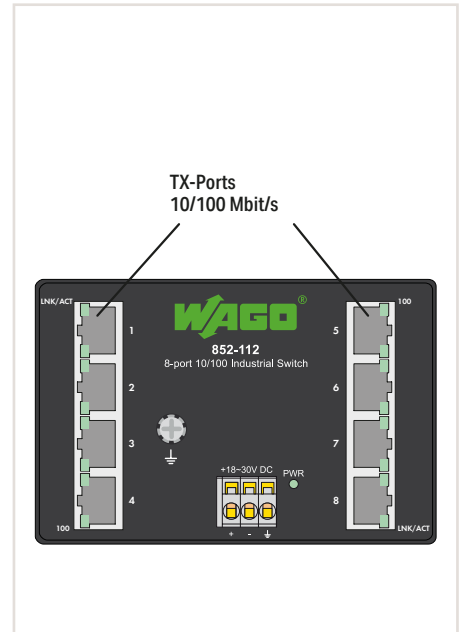
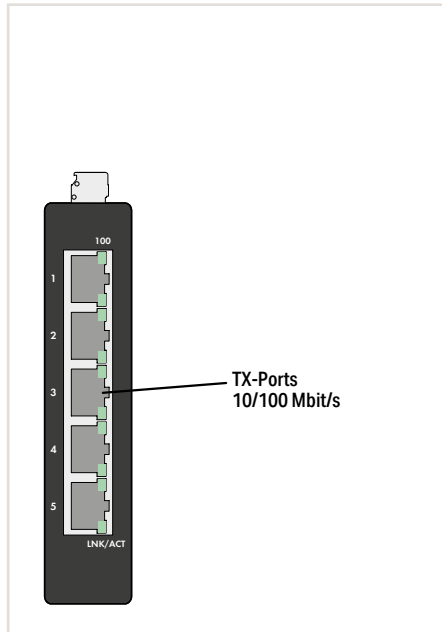
<b>Item Description</b>	<b>Industrial Managed Switch; 8-port 1000BASE-T; 4-slot 1000BASE-SX/LX; Extended temperature; 8 * Power over Ethernet</b>
<b>Item No.</b>	<b>852-1505</b>
<b>Order Text</b>	Industrial Managed Switch; 8-Port Gb; 4-Slot 1000BASE-SX/LX; EXT; 8PoE
<b>Technical Data</b>	
Switching mode	Store-and-forward, non-blocking
Number of copper ports	8 x 1000BASE-T; 8 x PoE+ (Power over Ethernet)
Number of FOC ports	4 x 1000BASE-SX/LX
Communication standards	IEEE 802.3 10BASE-T; IEEE 802.3u 100BASE-TX; IEEE 802.3ab 1000BASE-T; IEEE 802.3z 1000BASE-SX/LX; IEEE 802.3ad Port Trunk with LACP; IEEE 802.3x Flow Control; IEEE 802.1d Spanning Tree Protocol (STP); IEEE 802.1w Rapid Spanning Tree Protocol (RSTP); IEEE 802.1s Multiple Spanning Tree Protocol (MSTP); IEEE 802.1q VLAN Tagging; IEEE 802.1p Prioritization; IEEE 802.1x Port Authentication; IEEE 802.1ab Link Layer Discovery Protocol (LLDP); IEEE 802.3ad Port Trunk with LACP; IEEE 1588v2 Precision Time Protocol (PTP); IEEE 802.3af Power over Ethernet (PoE); IEEE 802.3at High Power over Ethernet (PoE+); ITU-T G8032v1/v2 Ethernet Ring Protection Switching (ERPS)
Redundancy functions	Redundant DC power supply; STP; RSTP; MSTP; Jet Ring < 300 ms; Xpress Ring < 20 ms; Dual Homing < 20 ms; Dual Ring; ERPSv2 < 50 ms; LCAP
Configuration	DIP switch for signal contact; Web-Based-Management; Command Line Interface; SNMPv1/v2c/v3
Diagnostics	Signal contact; Modbus TCP; Port status; Port statistics; Port load; Traffic monitor; SFP information; Syslog; Mail alarm; SNMP traps
MAC table (large)	16,000 addresses
Jumbo frame size	10 KB
Supply voltage	48 ... 57 VDC
Power consumption (max.)	18 W; 258 W with 8 PoE+
ESD (contact/air discharge)	8 KV / 15 KV
Connection technology (communication)	8 x RJ-45; 2 x SFP; 1 x RJ-45 (RS-232)
Communication standards	IEEE802.3x (in full duplex mode)
Surrounding air temperature (operation)	-40 ... +70 °C
Dimensions W x H x D	50 x 120 x 162 mm
Approvals	CE; OrdLoc*
Data sheet and further information, see:	wago.com/852-1505

\*pending

# Industrial Eco Switch



Figure: 852-111



Item Description	Industrial Eco Switch; 5-port 100BASE-TX 852-111	Industrial Eco Switch; 8-port 100BASE-TX 852-112
Item No.	852-111	852-112
Order Text	Industrial Eco Switch; 5Port	Industrial Eco Switch; 8Port
<b>Technical Data</b>		
Switching mode	Store-and-forward, non-blocking	Store-and-forward, non-blocking
Number of copper ports	5 x 100BASE-TX	8 x 100BASE-TX
Supported profiles	IEEE 802.3 10BASE-T; IEEE 802.3u 100BASE-TX; IEEE 802.3x Flow Control	IEEE 802.3 10BASE-T; IEEE 802.3u 100BASE-TX; IEEE 802.3x Flow Control
MAC table (large)	2000 addresses	2000 addresses
Jumbo frame size	1536 bytes	1536 bytes
Supply voltage	18 ... 30 VDC	18 ... 30 VDC
Power consumption (max.)	3 W	3 W
ESD (contact/air discharge)	4 KV / 8 KV	4 KV / 8 KV
Connection technology (communication)	5 x RJ-45	8 x RJ-45
Surrounding air temperature (operation)	-40 ... +70 °C	-40 ... +70 °C
Dimensions W x H x D	24 x 74 x 110 mm	110 x 24 x 74 mm
<b>Approvals</b>	CE, DNV GL; DNV (only with DNV mounting adapter); OrdLoc	CE, DNV GL; OrdLoc
Data sheet and further information, see:	<a href="http://wago.com/852-111">wago.com/852-111</a>	<a href="http://wago.com/852-112">wago.com/852-112</a>
<b>Accessories</b>	<b>Item No.</b> <b>Page</b>	
DNV mounting adapter	852-9101      413	

„ DNV mounting adapter, see page 413

„ Passive ETHERNET components, see Section "Accessories and Tools"

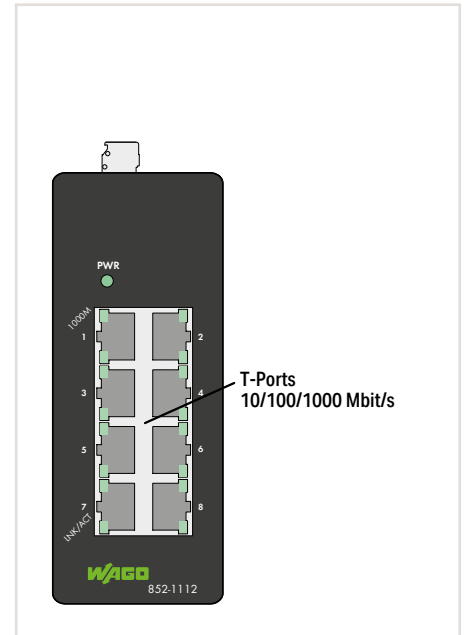
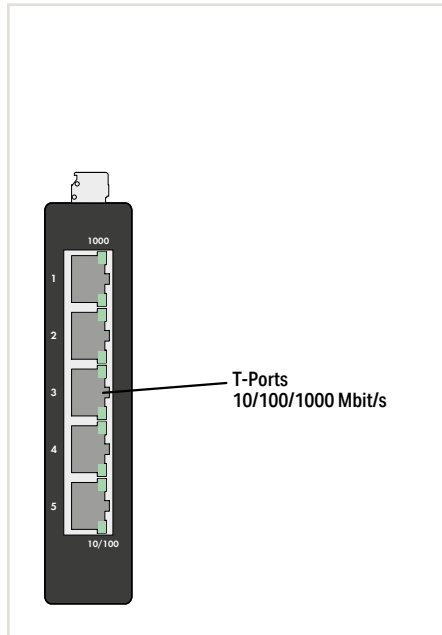
„ Approvals and corresponding ratings, see page 529 or [www.wago.com](http://www.wago.com)

7

# Industrial Eco Switch



Figure: 852-1112



Item Description	Industrial Eco Switch; 5-port 1000BASE-T 852-1111	Industrial Eco Switch; 8-port 1000BASE-T 852-1112
Item No.	852-1111	852-1112
Order Text	Industrial Eco Switch; 5-Port Gb	Industrial Eco Switch; 8-Port Gb
<b>Technical Data</b>		
Switching mode	Store-and-forward, non-blocking	Store-and-forward, non-blocking
Number of copper ports	5 x 1000BASE-T	8 x 1000BASE-T
Supported profiles	IEEE 802.3 10BASE-T; IEEE 802.3u 100BASE-TX; IEEE 802.3ab 1000BASE-T; IEEE 802.3x Flow Control; IEEE 802.3az Energy Efficient Ethernet; IEEE 802.1p Prioritization	IEEE 802.3 10BASE-T; IEEE 802.3u 100BASE-TX; IEEE 802.3ab 1000BASE-T; IEEE 802.3x Flow Control; IEEE 802.3az Energy Efficient Ethernet; IEEE 802.1p Prioritization
MAC table (large)	8000 addresses	8000 addresses
Jumbo frame size	9 kB	9 kB
Supply voltage	9 ... 48 VDC	9 ... 57 VDC
Power consumption (max.)	3 W	6 W
ESD (contact/air discharge)	4 KV / 8 KV	8 KV / 15 KV
Connection technology (communication)	5 x RJ-45	8 x RJ-45
Surrounding air temperature (operation)	-40 ... +70 °C	0 ... +60 °C
Dimensions W x H x D	24 x 74 x 110 mm	50 x 100 x 116 mm
Approvals (*pending)	CE; DNV GL; DNV (only with DNV mounting adapter); OrdLoc*	CE; OrdLoc*
Data sheet and further information, see:	<a href="http://wago.com/852-1111">wago.com/852-1111</a>	<a href="http://wago.com/852-1112">wago.com/852-1112</a>
<b>Accessories</b>	<b>Item No.</b> <b>Page</b>	
DNV mounting adapter	852-9101      413	

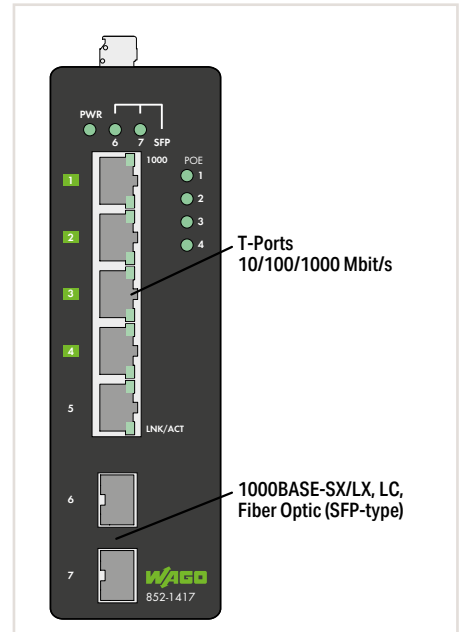
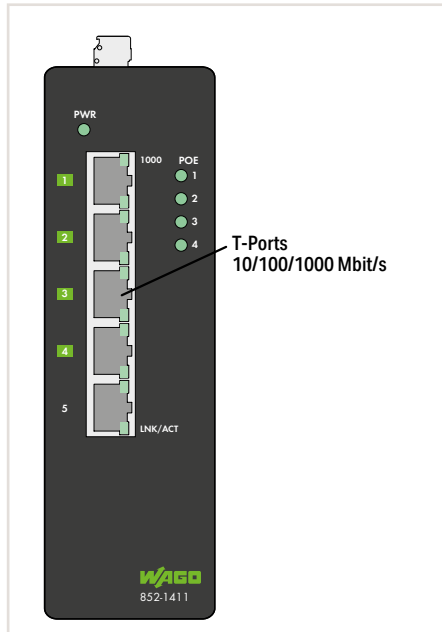
\*pending

\*pending

# Industrial Eco Switch



Figure: 852-1417



<b>Item Description</b>	<b>Industrial Eco Switch; 5-port 1000BASE-T; Extended temperature; 4 * Power over Ethernet</b>	<b>Industrial Eco Switch; 5-port 1000BASE-T; 2-slot 1000BASE-SX/LX; Extended temperature; 4 * Power over Ethernet</b>
<b>Item No.</b>	852-1411	852-1417
<b>Order Text</b>	Industrial Eco Switch; 5Port Gb; EXT; 4PoE	Industrial Eco Switch; 5Port Gb; 2-Slot 1000BASE-SX/LX; EXT; 4PoE

<b>Technical Data</b>		
Number of copper ports	5 x 1000BASE-T; 8 x PoE+ (Power over Ethernet)	5 x 1000BASE-T; 8 x PoE+ (Power over Ethernet)
Number of FOC ports		2 x 1000BASE-SX/LX
Supported profiles	IEEE 802.3 10BASE-T; IEEE 802.3u 100BASE-TX; IEEE 802.3ab 1000BASE-T; IEEE 802.3x Flow Control; IEEE 802.3af Power over Ethernet (PoE); IEEE 802.3at High Power over Ethernet (PoE+); IEEE 802.1p Prioritization	IEEE 802.3 10BASE-T; IEEE 802.3u 100BASE-TX/FX; IEEE 802.3ab 1000BASE-T; IEEE 802.3z 1000BASE-SX/LX; IEEE 802.3x Flow Control; IEEE 802.3af Power over Ethernet (PoE); IEEE 802.3at High Power over Ethernet (PoE+); IEEE 802.1p Prioritization
Topology	Star	Star
Jumbo frame size	10 KB	10 KB
MAC table (large)	8000 addresses	8000 addresses
Supply voltage	24 ... 57 VDC	24 ... 57 VDC
Power consumption (max.)	13 W; 133 W with 4 PoE	14 W; 134 W with 4 PoE
Connection technology (communication)	5 x RJ-45	5 x RJ-45; 2 x SFP
Surrounding air temperature (operation)	-40 ... +70 °C	-40 ... +70 °C
Dimensions W x H x D	50 x 120 x 160 mm	50 x 120 x 160 mm
<b>Approvals</b>	CE, OrdLoc*	CE, OrdLoc*
<b>Data sheet and further information, see:</b>	<a href="http://wago.com/852-1411">wago.com/852-1411</a>	<a href="http://wago.com/852-1417">wago.com/852-1417</a>

\*pending

\*pending

- „ SFP Modules, see page 412
- „ Passive ETHERNET components, see Section "Accessories and Tools"
- „ Approvals and corresponding ratings, see page 529 or www.wago.com

7

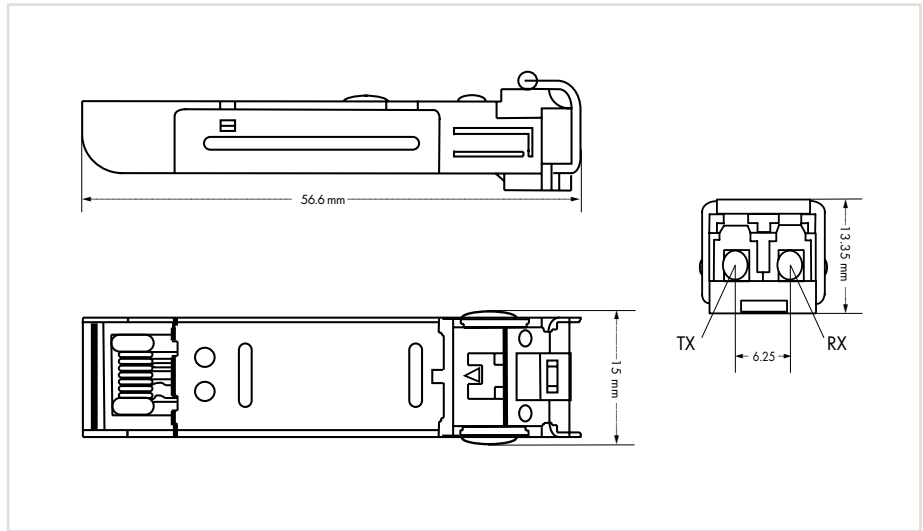
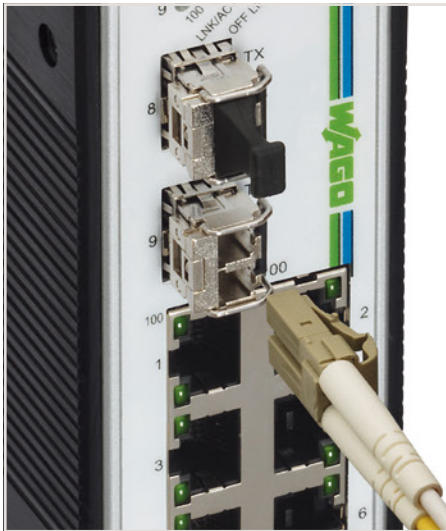
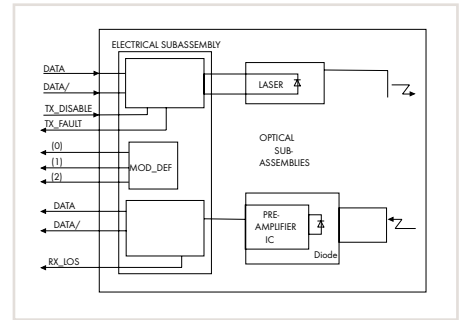
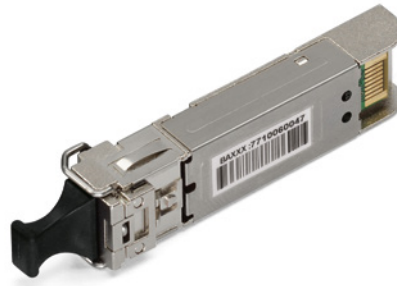
7

# Industrial Switches – Accessories

## SFP Modules

**Features:**

- Duplex LC optical connector
- Small Form-Factor Pluggable (SFP) industry-standard design
- Compliant with Fast ETHERNET standard and Gigabit ETHERNET standard IEEE802.3z
- Differential LVPECL inputs and outputs
- Supply voltage: 3.3 V
- TTL signal detect indicator
- Hot-pluggable capability



<b>Item Description</b>
<b>Version</b>
<b>Item No.</b>
<b>Order Text</b>

<b>SFP Module; 100BASE</b>
<b>FX Multi-Mode 1310 nm LC; 2 km</b>
<b>852-201/107-002</b>
SFP Module 2: 1310nm; 100BASE-FX Multi-Mode LC; 2 km

<b>SFP Module 1000BASE; Extended temperature; DDM</b>
<b>SX Multi-Mode 850 nm LC; 0.55 km</b>
<b>852-1200</b>
SFP Module 1000BASE; SX Multi-Mode 850 nm LC; 0.55 km; EXT; DDM

<b>Technical Data</b>
Wavelength
Multi-mode fiber
Lengths (max.)
Laser type
Other
Surrounding air temperature (operation)
Dimensions W x H x D
<b>Data sheet and further information, see:</b>

1310 nm
62.5/125 µm; 50/125 µm
2 km
Laser class 1 per EN 60825-1
-40 ... +70 °C
13.4 x 13.3 x 56.6 mm
<a href="http://wago.com/852-201/107-002">wago.com/852-201/107-002</a>

850 nm
62.5/125 µm; 50/125 µm
300 m; 550 m
Laser class 1 per EN 60825-1
Supports "Digital Diagnostics Monitoring"
-40 ... +85 °C
13.4 x 13.3 x 56.6 mm
<a href="http://wago.com/852-1200">wago.com/852-1200</a>

<b>Item Description</b>
<b>Version</b>
<b>Item No.</b>
<b>Order Text</b>

<b>SFP Module; 100BASE</b>
<b>FX Single-Mode 1310 nm LC; 30 km</b>
<b>852-201/107-030</b>
SFP Module 30: 1310nm; 100BASE-FX Single-Mode LC; 30 km

<b>SFP Module 1000BASE; Extended temperature; DDM</b>
<b>LX Single-Mode 1310 nm LC; 10 km</b>
<b>852-1210</b>
SFP Module 1000BASE; LX Single-Mode 1310 nm LC; 10 km; EXT; DDM

<b>ZX Single-Mode 1550 nm LC; 80 km</b>
<b>852-1280</b>
SFP Module 1000BASE; ZX Single-Mode 1550 nm LC; 80 km; EXT; DDM

<b>Technical Data</b>
Wavelength
Single-mode fiber
Lengths (max.)
Laser type
Other
Surrounding air temperature (operation)
Dimensions W x H x D
<b>Data sheet and further information, see:</b>

1310 nm
9/125 µm
30 km
Laser class 1 per EN 60825-1
0 °C ... +60 °C
13.4 x 13.3 x 56.6 mm
<a href="http://wago.com/852-201/107-030">wago.com/852-201/107-030</a>

1310 nm	1550 nm
9/125 µm	
10 km	80 km
Laser class 1 per EN 60825-1	
Supports "Digital Diagnostics Monitoring"	
-40 ... +85 °C	
13.4 x 13.3 x 56.6 mm	
<a href="http://wago.com/852-1210">wago.com/852-1210</a>	<a href="http://wago.com/852-1280">wago.com/852-1280</a>

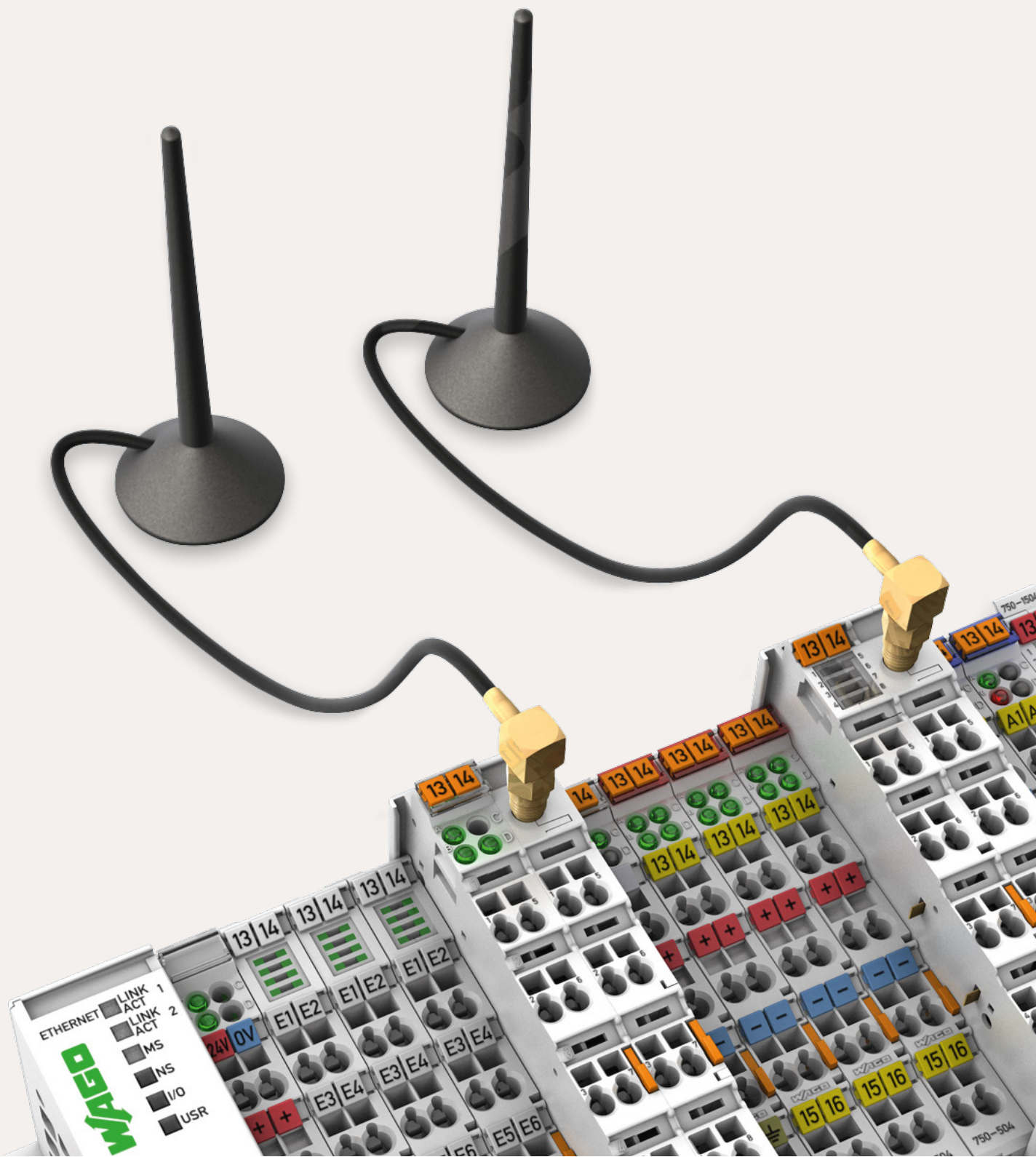
7

## Industrial Switches – Accessories

### DNV Mounting Adapter with Marine Approval



<b>Item Description</b>	<b>DNV Mounting Adapter; for 852-111/852-1111 Industrial Switches with maritime approval</b>
<b>Item No.</b>	<b>852-9101</b>
<b>Order Text</b>	DNV Mounting Adapter; Switches
<b>Technical Data</b>	
Dimensions W x H x D	20 x 9.6 x 102.2 mm
Weight	32.8 g
Data sheet and further information, see:	<a href="http://wago.com/852-9101">wago.com/852-9101</a>



# Radio Technology









## Radio Technology

- Bluetooth®
- WLAN
- EnOcean®



## Wireless Technology – Bluetooth®, WLAN and EnOcean® Components

### Contents

		Page	
<b>General Product Information</b>		416	
<b>Interfaces and Types</b>		417	
<b>Application and Installation Instructions</b>		418	
		Item No.	
		<b>Wireless ETHERNET Gateway</b> 758-918	420
		<b>WAGO Radio Adapter</b> 750-921	421
		<b>I/O System 750, Communication Module, EnOcean Radio Receiver</b> 750-642	422
		<b>Radio Transmitter, EnOcean® easyfit PTM 250</b> 2-Channel Lighting Control 4-Channel Lighting Control 2-Channel Blind Control 4-Channel Blind Control	423 758-940/001-000 758-940/003-000 758-940/002-000 758-940/004-000
	<b>Accessories</b> Antennas		424

## Radio Technology

### General Product Information

#### Wireless Technology in the Industrial Environment

Wireless technology can support wired applications or enable completely new applications.

In mobile or movable systems, wireless technology is the first choice when greater distances or obstacles must be overcome. It is an alternative for applications in which wired solutions are not economical or technically feasible.

Various wireless technologies can be used depending on the application.



**Bluetooth® – Robust,  
Flexible, High-Performance**

Well-known in consumer electronics, *Bluetooth®* technology is also well-suited to industrial use with its internationally approved frequency range, a very robust transmission technology (frequency hopping), real-time response and a range of up to 400 m. It makes wireless process data communication between two stations possible (point-to-point communication), and also enables the setup of a piconet in which a *Bluetooth®* master can communicate with up to seven slaves, e.g., decentralized mobile sensors. In addition, *Bluetooth®* can be used as the radio system for commissioning.

Features:

- Secure transmission (encrypted)
- AFH (Adaptive Frequency Hopping)
- Adaptive transmission power
- Uses the license-free 2.4 GHz frequency band



**WLAN – Full  
IT Integration**

WLAN makes it easy to setup a wireless transmission link for ETHERNET protocols. This can be standard ETHERNET protocols, e.g., for communication between a smartphone and automation components. Industrial fieldbus protocols such as PROFINET, Modbus TCP or Ethernet/IP can also be used to link mobile equipment with stationary equipment. Ranges up to 400 m are possible depending on the transmission technology used.



**enocean®**

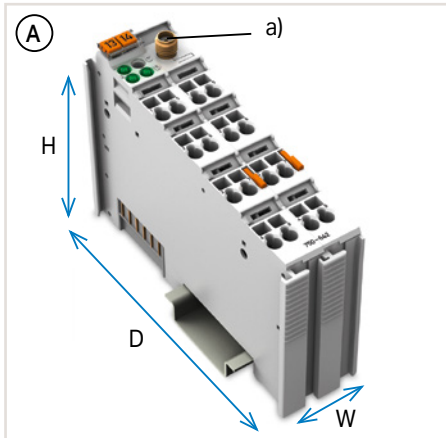
**EnOcean® – The Radio  
Standard in Building  
Automation**

Wireless switches and sensors based on EnOcean® technology harvest available energy to power themselves, e.g., kinetic energy from actuating a switch or sensors powered by ambient light. This energy harvesting completely eliminates maintenance of the radio transmitter at a range of up to 300 m in open air (30 m in buildings).

#### Advantages:

- Branch and application-specific – always the right radio system
- Industrial design: high-performance, rugged and safe
- Tightly integrated into WAGO automation technology

## Radio Technology Interfaces and Types

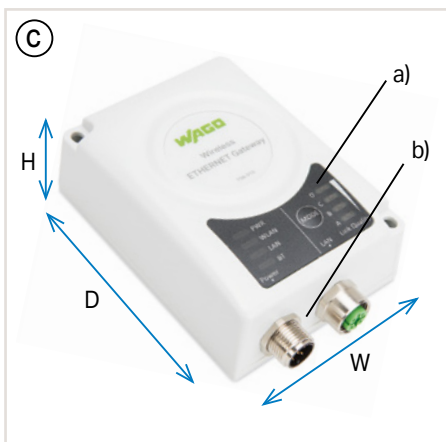
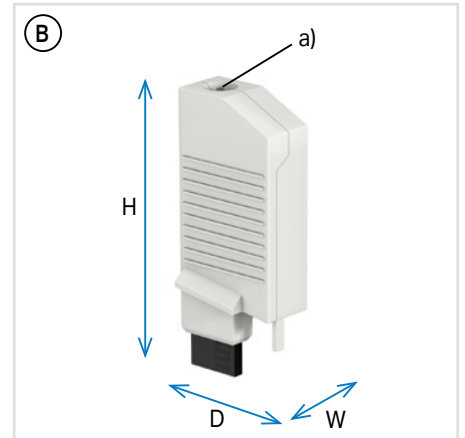


### Communication Module for I/O System (A)

- For use with:
  - Controller (PFC)
  - Fieldbus coupler (FC), 750 Series I/O System
- Antenna connection (a)
- W x H x D (mm) 24 x 72 x 100, plus approx. 6.5 mm of excess length with antenna socket

### Radio Adapter (B)

- For use with:
  - PFC, 750 XTR Series PFC, FC, 750 XTR Series FC
  - Signal Conditioners, 2857 and 857 Series
- Integrated antenna
- Diagnostic LED (a)
- W x H x D (mm) 15 x 50 x 19



### ETHERNET Gateway (C)

- Integrated converter from ETHERNET protocols to radio technology
- Integrated antenna
- Diagnostic LEDs (a)
- Connections with M12 connectors (b)
- Protection class: IP65
- W x H x D (mm) 66 x 36.2 x 91

### Switch Inserts (D)

- Universal switch inserts for standard switch series in building automation
- Compatible with manufacturer programs from BERKER, GIRA, JUNG, MERTEN

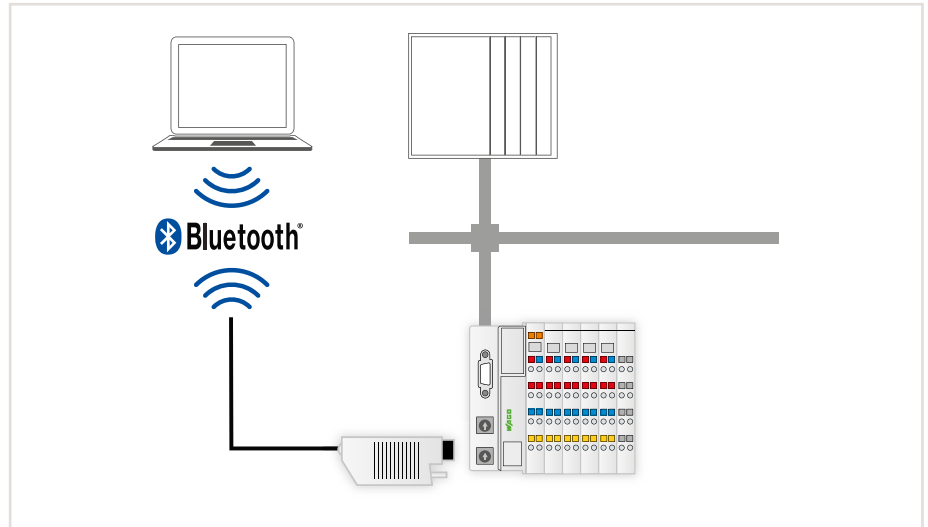


## Radio Technology

### Application and Installation Instructions

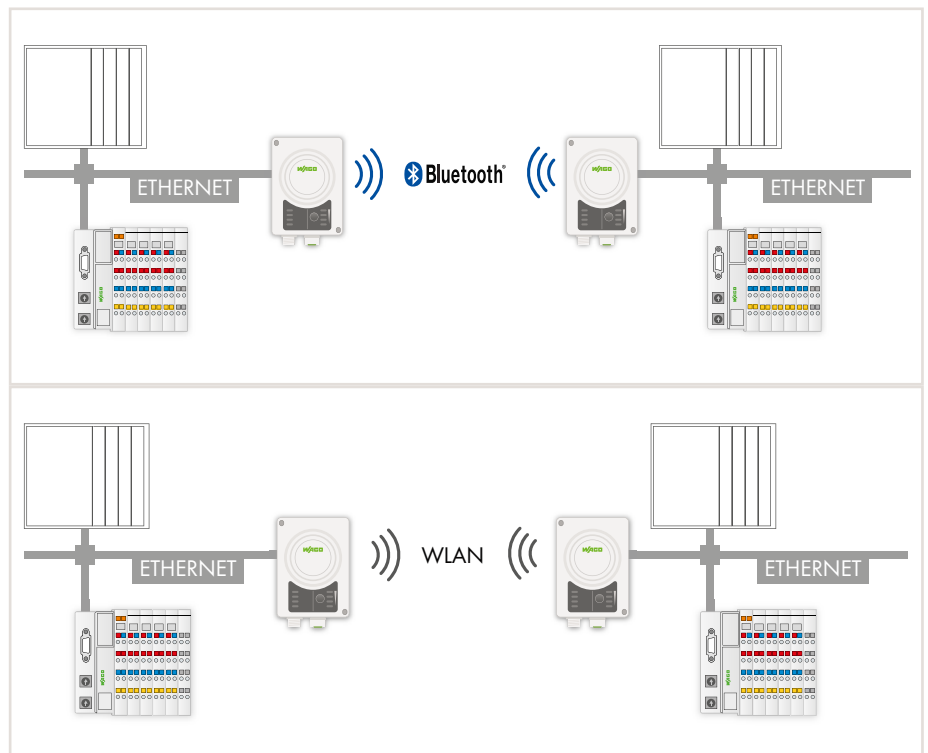
#### Wireless Engineering

- Commissioning, maintenance
- Connect WAGO software on a PC/notebook to a product's service interface
- Controllers
- Controllers XTR
- Fieldbus couplers, I/O System 750
- Fieldbus couplers, I/O System 750 XTR
- Temporary install via compact *Bluetooth*<sup>®</sup> Adapter



#### Tunneling ETHERNET Fieldbuses

- Point-to-point connection (between two nodes), e.g., for connecting mobile units to a central controller or for connecting stationary stations
- Tunneling PROFINET, Modbus TCP, Ethernet/IP, etc., via *Bluetooth*<sup>®</sup> wireless technology or WLAN
- Process data coupling
- Range: up to 400 m in open air

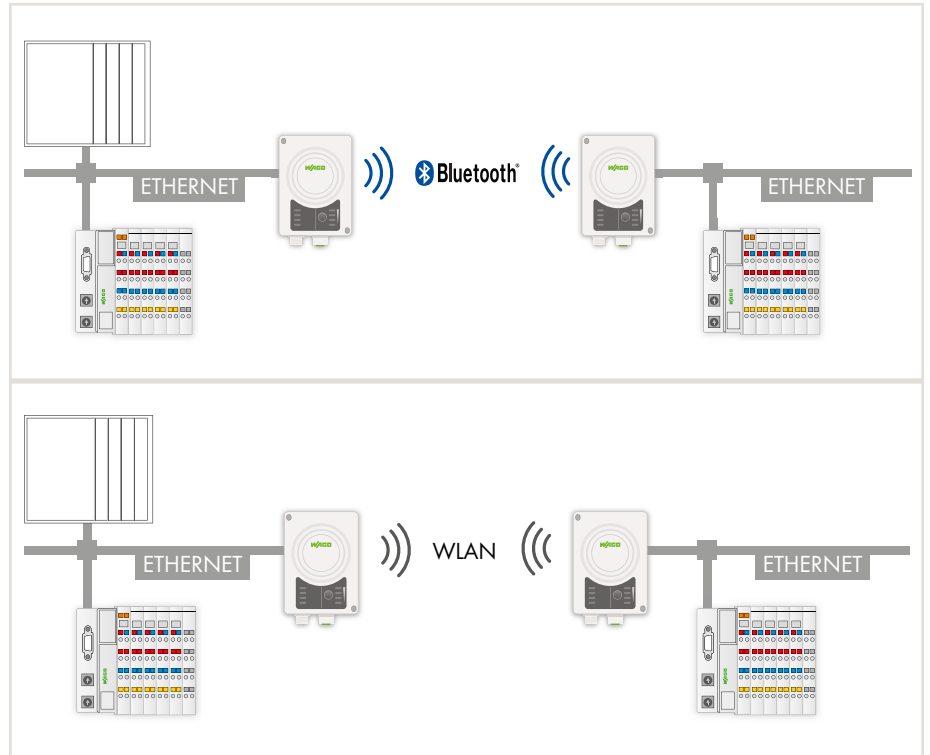


## Radio Technology

### Application and Installation Instructions

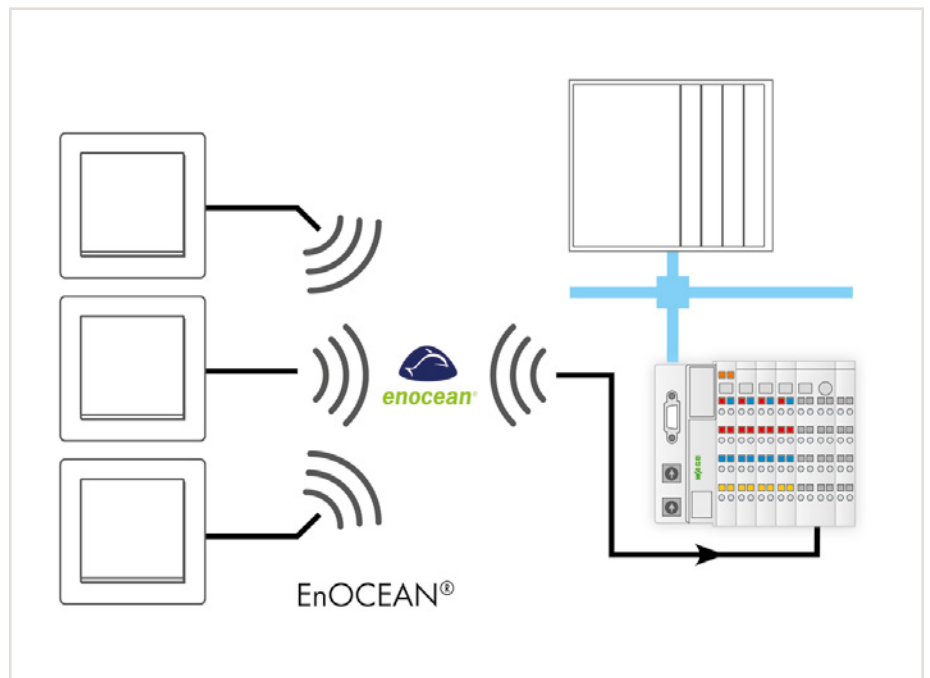
#### Connecting Mobile Systems

- Tunneling ETHERNET telegrams via *Bluetooth*® radio technology or WLAN
- Point-to-point connection (between two nodes), e.g., for coupling a mobile unit with a stationary basic system
- Process data coupling
- Range: up to 400 m in open air



#### Integration into the WAGO-I/O-SYSTEM via EnOcean Radio Technology

- Radio receiver in the I/O module
- Operation on:
  - Controllers
  - Fieldbus couplers
- Range: Up to 300 m in open air, approx. 30 m in buildings



## WLAN ETHERNET Gateway



### Power connector:

M12 plug, A-coded



- 1: Vin + (9 ... 30 VDC)
- 2: Digital input GND
- 3: Vin GND (0 V)
- 4: Digital input + (9 ... 30 VDC)
- 5: Functional ground

### ETHERNET connector:

M12 socket, D-coded



- 1: Transmit +
- 2: Receive +
- 3: Transmit -
- 4: Receive -

Item Description	Wireless ETHERNET Gateway
Item No.	758-918
Order Text	Wireless ETHERNET Gateway
<b>Technical Data</b>	
Radio technology	<i>Bluetooth</i> ®: 4.0; WLAN: 802.11a/b/g/d/e/i/h
Topology	Peer-to-peer connection
Security authentication	WLAN: WPA/WPA2 PSK; LEAP; PEAP
Security encryption	WLAN: none; WEP64; WEP128; TKIP; AES/CCMP
Frequency band	ISM band; 2.4 GHz ( <i>Bluetooth</i> ®, WLAN); ISM band; GHz (WLAN)
Transmission range	Up to 400 m*
Antenna	Internal directional antenna
Supply voltage	24 VDC (9 ... 30 V)
Connectors	- ETHERNET: M12 connector, D-coded, - Supply: M12 connector, A-coded
Configuration	Simple push-button operation and Web-Based Management
Number of inputs	1 (trigger input: 9 ... 30 VDC)
Surrounding air temperature (operation)	-30 ... +65 °C
Dimensions W x H x D	67.8 x 33.2 x 92.7
Protection type	IP65
Approvals	CE
Data sheet and further information, see:	<a href="http://wago.com/758-918">wago.com/758-918</a>

\*The maximum range in the field decreases with use in buildings and changes depending on the building materials used and the spatial geometry. Therefore, range specifications within buildings can only represent typical values which can normally be achieved. More detailed information is available in the manual.

The Wireless ETHERNET Gateway simplifies creation of a wireless transmission link for ETHERNET protocols (e.g., PROFINET, MODBUS/TCP, Ethernet/IP).

The gateway is used as a cable substitute to create a robust, industry-proven *Bluetooth*® or WLAN link between two automation devices.

The gateway supports various configurations and can therefore also be operated as an access point.

Both IP65 housing and internal directional antenna allow the gateway to be used in harsh industrial environments. Simple push-button operation rapidly connects two Wireless ETHERNET Gateways.

Additional settings can be made via Web-Based Management.

### Note:

Two Wireless ETHERNET Gateways of the same type are required to establish a peer-to-peer connection.

„ Marking strips, felt-tip pen,  
see Section "Accessories and Tools"

„ IP67 cables and pluggable connectors,  
see Section "Accessories and Tools"

## Bluetooth® Adapter



<b>Item Description</b>	<b>Bluetooth® Adapter</b>
<b>Item No.</b>	<b>750-921</b>
<b>Order Text</b>	Bluetooth® Adapter
<b>Technical Data</b>	
Transmission range	20 m in open air (Class 2)*
Data transmission rate	9600 ... 115,000 bit/s
Frequency range	ISM band; 2402 ... 2483 MHz
Type of communication	Peer-to-peer connection
Supported profiles	Serial Port Profile (SPP)
Radio technology	Bluetooth® 2.1
Antenna	Integrated
Connectors	4-pole service connectors
Configuration	AT commands (e.g., via HyperTerminal)
Function	Master or slave
LED	Operating mode
Security encryption	128-bit encryption
Surrounding air temperature (operation)	-20 ... +60 °C
Dimensions W x H x D	15 x 50 x 19 mm
<b>Approvals</b>	Bluetooth® approval; CE
<b>Data sheet and further information, see:</b>	<a href="http://wago.com/750-921">wago.com/750-921</a>

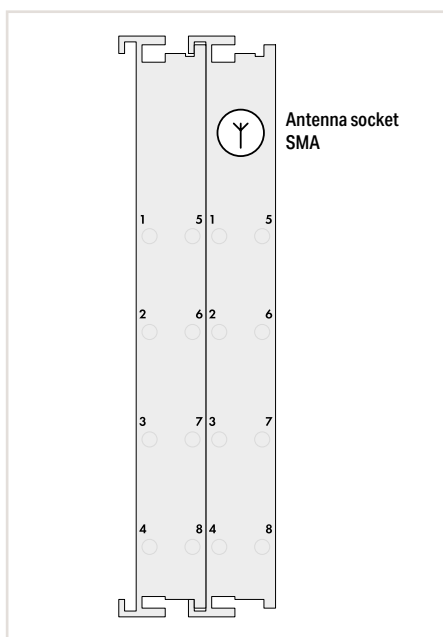
The *Bluetooth®* Adapter wirelessly connects a notebook computer with *Bluetooth®* functionality to the service interface of the fieldbus coupler/controller. It also provides an active connection to a controller.

As a cable substitute, the *Bluetooth®* Adapter allows communication between two controllers, as well as between fieldbus couplers/controllers via WAGO Software Tools.

The adapter is supplied via both service interface and power supply of the coupler/controller.

\*The maximum range in the field decreases with use in buildings and changes depending on the building materials used and the spatial geometry. Therefore, range specifications within buildings can only represent typical values which can normally be achieved. More detailed information is available in the manual.

## Radio Receiver EnOcean



<b>Item Description</b>	<b>Radio Receiver EnOcean</b>	
<b>Version</b>	<b>Standard</b>	
<b>Item No.</b>	750-642	
<b>Order Text</b>	Radio Receiver EnOcean	
<b>Technical Data</b>		
Antenna	External via SMA socket	
Frequency band	868.3 MHz	
Transmission range	Up to 300 m in open field (30 m typical in buildings, see manual)*	
Transmission protocol (radio telegram)	EnOcean	
Supply voltage (system)	5 VDC; via data contacts	
Current consumption – system supply (5 V)	80 mA	
Data width (internal)	1 x 24-bit input/output (3-byte user data); 1 x 8-bit control/status	
Surrounding air temperature (operation)	0 ... +55 °C	
Dimensions W x H x D	24 x 72 x 100 mm	
<b>Approvals</b>	CE;  OrdLoc/HazLoc;  ATEX/IECEX	
<b>Data sheet and further information, see:</b>	<a href="http://wago.com/750-642">wago.com/750-642</a>	
<b>Accessories</b>	<b>Item No.</b>	<b>Page</b>
External antenna	758-910	424

This radio receiver obtains radio telegrams from maintenance-free, self-powered and wireless switches/sensors based on EnOcean radio technology.

The energy required for switch or sensor operation is produced by converting one type of energy (heat, solar or mechanical energy) into usable electrical energy.

The LED (RSSI) indicates a sufficient input level.

Preprogrammed function blocks for WAGO Controllers make integration easy.

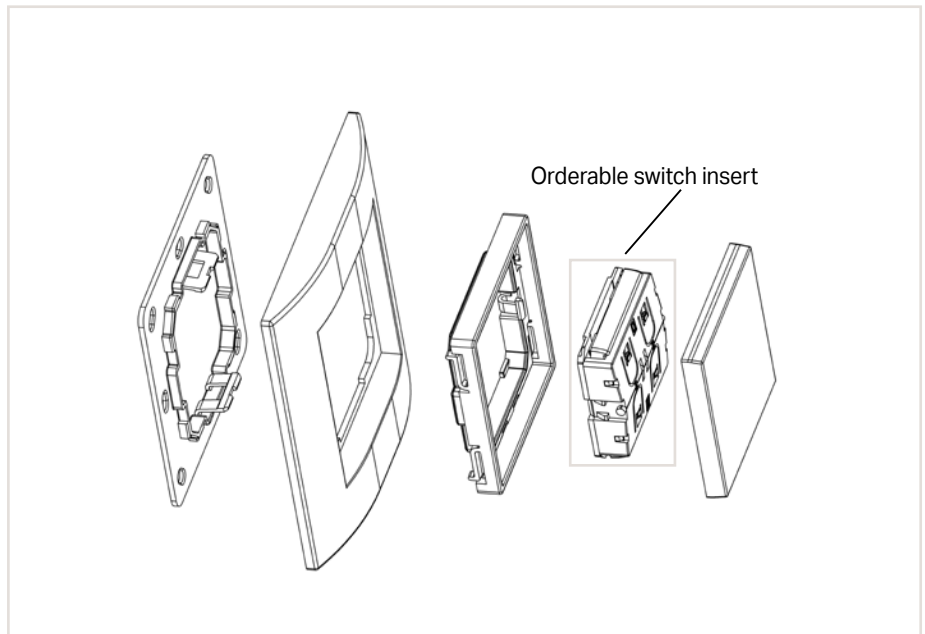
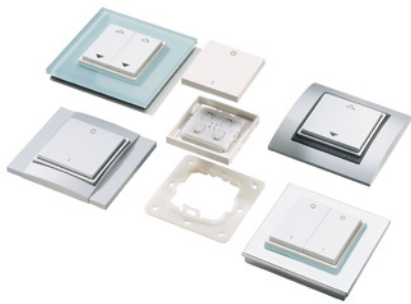
\*The maximum range in the field decreases with use in buildings and changes depending on the building materials used and the spatial geometry. Therefore, range specifications within buildings can only represent typical values which can normally be achieved. More detailed information is available in the manual.

„ Mini-WSB marker card and mounting accessories, see Section "Accessories and Tools"

„ Approvals and corresponding ratings, see page 522 or [www.wago.com](http://www.wago.com)



## Radio Transmitter; EnOcean easyfit PTM 250



Item Description	Radio Transmitter; EnOcean easyfit PTM 250			
Version	2-channel lighting control	4-channel lighting control	2-channel blind control	4-channel blind control
Item No.	758-940/001-000	758-940/003-000	758-940/002-000	758-940/004-000
Order Text	Radio Transmitter; EnOcean easyfit PTM 250; 2-Channel Light	Radio Transmitter; EnOcean easyfit PTM 250; 4-Channel Light	Radio Transmitter; EnOcean easyfit PTM 250; 2-Channel Sunblind	Radio Transmitter; EnOcean easyfit PTM 250; 4-Channel Sunblind
<b>Technical Data</b>				
Integrated radio transmitter	EnOcean PTM 200			
Radio technology	EnOcean 868 MHz; RPS type 2			
Range	300 m in open air; 30 m (typ.) within buildings*			
Antenna	Integrated			
Total installation height	14 mm (frame lies directly on surface)			
Dimensions of rocker/frame cut-out/center plate	50 x 50 mm / 55 x 55 mm / 71 x 71 mm			
Assembly	Flat surface; glued (double-sided mounting film enclosed) or screwed			
Color	Pure white			
Rocker switch variant	Rocker switch with neutral middle position	Series rocker switch	Rocker switch with neutral middle position	Series rocker switch
Relative humidity	95 % (non condensing)			
Surrounding air temperature (operation)	-25 ... +65 °C			
Compatibility	BERKER, GIRA, JUNG, MERTEN			
Approvals	R&TTE, CE			
Data sheet and further information, see:	<a href="http://wago.com/758-940">wago.com/758-940</a>			

PTM 250 is a universal, extremely flat function switch insert with maintenance-free energy generator. The universal switch insert fits in numerous frame programs from various installation material suppliers. The base plate can be glued or screwed into position for easy attachment to glass as well as plaster. Integration into the frame is similar to universal inserts for antenna sockets.

Delivered without frame; frames must be ordered separately from the desired manufacturer program!

\*The maximum range in the field decreases with use in buildings and changes depending on the building materials used and the spatial geometry. Therefore, range specifications within buildings can only represent typical values which can normally be achieved. More detailed information is available in the manual.

## External Antenna



<b>Item Description</b>	<b>Magnetic-Mount Antenna, GSM 900/1800; External antenna</b>	<b>Magnetic-Mount Antenna, WLAN/Bluetooth® 2.4 GHz; External antenna</b>
<b>Item No.</b>	758-910	758-912
<b>Order Text</b>	Magnetic-Mount Antenna, GSM 900/1800; External antenna	Magnetic-Mount Antenna, WLAN/Bluetooth®; External antenna
<b>Technical Data</b>		
Frequency band	870 ... 960 MHz; 1710 ... 1880 MHz	2400 ... 2485 MHz
VSWR	< 1.5	
Gain	0 dB	2 dBi
Power (max.)	20 W	
Cable length	250 cm	250 cm
Connector	SMA angled plug + ferrite bead	SMA angled plug
<b>Data sheet and further information, see:</b>	<a href="http://wago.com/758-910">wago.com/758-910</a>	<a href="http://wago.com/758-912">wago.com/758-912</a>

Notes on operating the antenna with WAGO EnOcean Radio Receivers:

- The antenna is to be mounted on a plate measuring at least 25 x 25 cm.
- The distance of interfering sources to the antenna and antenna line must be at least 30 cm and the free space between the antenna and the next wall must be at least 35 cm.
- The antenna cable should, under no circumstances, be bent sharply, since irreversible damage may result to the antenna line (RG174 bending radius > 15 mm).










# Sensor/Actuator Boxes

## Sensor/Actuator Boxes

- M8 and M12 sensor/actuator boxes
- Passive signal acquisition and output at the machine level
- Fully encapsulated

## Sensor/Actuator Boxes

### Contents

			Page	
	<b>General Product Information</b>		428	
	<b>Item Number Key</b>		429	
	<b>Standards and Rated Conditions</b>		429	
	<b>Approvals</b>		429	
	<b>Interfaces and Types</b>		430	
		<b>Description</b>	<b>Item No.</b>	
	<b>M12 Sensor/Actuator Boxes with Cable Connection</b>	M12 Sensor/Actuator Box; 4-way, 4-pole; 5 m connecting cable	757-244/000-005	432
		M12 Sensor/Actuator Box; 4-way, 4-pole; 10 m connecting cable	757-244/000-010	
		M12 Sensor/Actuator Box; 6-way, 4-pole; 5 m connecting cable	757-264/000-005	432
		M12 Sensor/Actuator Box; 6-way, 4-pole; 10 m connecting cable	757-264/000-010	
		M12 Sensor/Actuator Box; 8-way, 4-pole; 5 m connecting cable	757-284/000-005	433
		M12 Sensor/Actuator Box; 8-way, 4-pole; 10 m connecting cable	757-284/000-010	
		M12 Sensor/Actuator Box; 8-way, 4-pole; 25 m connecting cable	757-284/000-025	
		M12 Sensor/Actuator Box; 4-way, 5-pole; 5 m connecting cable	757-245/000-005	434
		M12 Sensor/Actuator Box; 4-way, 5-pole; 10 m connecting cable	757-245/000-010	
		M12 Sensor/Actuator Box; 6-way, 5-pole; 5 m connecting cable	757-265/000-005	434
		M12 Sensor/Actuator Box; 6-way, 5-pole; 10 m connecting cable	757-265/000-010	
		M12 Sensor/Actuator Box; 8-way, 5-pole; 5 m connecting cable	757-285/000-005	435
		M12 Sensor/Actuator Box; 8-way, 5-pole; 10 m connecting cable	757-285/000-010	
		M12 Sensor/Actuator Box; 8-way, 5-pole; 25 m connecting cable	757-285/000-025	
	<b>M12 Sensor/Actuator Boxes with M23 Connector</b>	M12 Sensor/Actuator Box; 4-way; 4-pole; M23 connector	757-144	436
		M12 Sensor/Actuator Box; 6-way; 4-pole; M23 connector	757-164	436
		M12 Sensor/Actuator Box; 8-way; 4-pole; M23 connector	757-184	437
		M12 Sensor/Actuator Box; 4-way; 5-pole; M23 connector	757-145	438
		M12 Sensor/Actuator Box; 6-way; 5-pole; M23 connector	757-165	438
		M12 Sensor/Actuator Box; 8-way; 5-pole; M23 connector	757-185	439
		M12 Sensor/Actuator Box; 8-way; 5-pole; M23 connector; without LED	757-185/100-000	
	<b>M8 Sensor/Actuator Boxes with Cable Connection</b>	M8 Sensor/Actuator Box; 4-way, 3-pole; 2 m connecting cable	757-443/000-002	440
		M8 Sensor/Actuator Box; 4-way, 3-pole; 5 m connecting cable	757-443/000-005	
		M8 Sensor/Actuator Box; 4-way, 3-pole; 10 m connecting cable	757-443/000-010	
		M8 Sensor/Actuator Box; 6-way, 3-pole; 5 m connecting cable	757-463/000-005	440
		M8 Sensor/Actuator Box; 6-way, 3-pole; 10 m connecting cable	757-463/000-010	
		M8 Sensor/Actuator Box; 8-way, 3-pole; 5 m connecting cable	757-483/000-005	441
		M8 Sensor/Actuator Box; 8-way, 3-pole; 10 m connecting cable	757-483/000-010	
		M8 Sensor/Actuator Box; 10-way, 3-pole; 5 m connecting cable	757-403/000-005	441
		M8 Sensor/Actuator Box; 10-way, 3-pole; 10 m connecting cable	757-403/000-010	
	<b>M8 Sensor/Actuator Boxes with M16 Connector</b>	M8 Sensor/Actuator Box; 4-way; 3-pole; M16 connector	757-343	442
		M8 Sensor/Actuator Box; 6-way; 3-pole; M16 connector	757-363	442
		M8 Sensor/Actuator Box; 8-way; 3-pole; M16 connector	757-383	443
		M8 Sensor/Actuator Box; 10-way; 3-pole; M16 connector	757-303	443
	<b>Accessories</b>			444
	Marking cards, marking strips, protective caps, spacer modules, interconnecting cables			

## Sensor/Actuator Boxes

### General Product Information

#### For Signal Acquisition at the Machine Level

Passive M8/M12 sensor/actuator boxes are placed close to the process and acquire signals at the machine level. They can be used under very harsh environmental conditions and establish the connection between sensors/actuators and the controller via molded or detachable cables. Use of standardized pluggable connections supports sensor and actuator plug & play, while the use of trunk cables replaces the individual wiring of I/O signals to automation components in the control cabinet. Cabling is well-organized and minimized.

#### Signal Acquisition in Exceptionally Harsh Conditions

WAGO's sensor/actuator boxes with molded cable (72 hours at 1 m water depth) have an extremely robust design and meet both IP67 and IP68 protection standards. This design makes them ideal for applications where signals must be recorded in extreme environments (temperature, shock, vibration) without a control cabinet. They're also excellent alternatives when the use of an active IP67 I/O system would not be cost-effective due to a low signal count or the simple signal conditions (only digital signal acquisition/output).

#### Plug-&-Play Connection Technology

The IP67 sensor/actuator boxes with a removable connecting cable (M16 or M23 pluggable connector) are ideal for areas where frequent easy disconnection and reconnection are required (e.g., transport, modification, service).

#### Fixed Trunk Cable

The IP68 sensor/actuator boxes with molded cables are preferred when challenging cable paths do not allow the use of preassembled M16/M23 cables.

#### Extreme Mechanical Performance

A system/machine is exposed to severe mechanical and thermal influences. It is important to process its signals despite severe vibrations and shocks. The sensor/actuator boxes are used at the machine level. Full encapsulation safeguards system operation, so that even extreme vibration and temperature loads do not degrade signal acquisition and power supply via the connecting cable to the controller or other automation components located in the non-critical control cabinet area.

#### Flexible Assembly

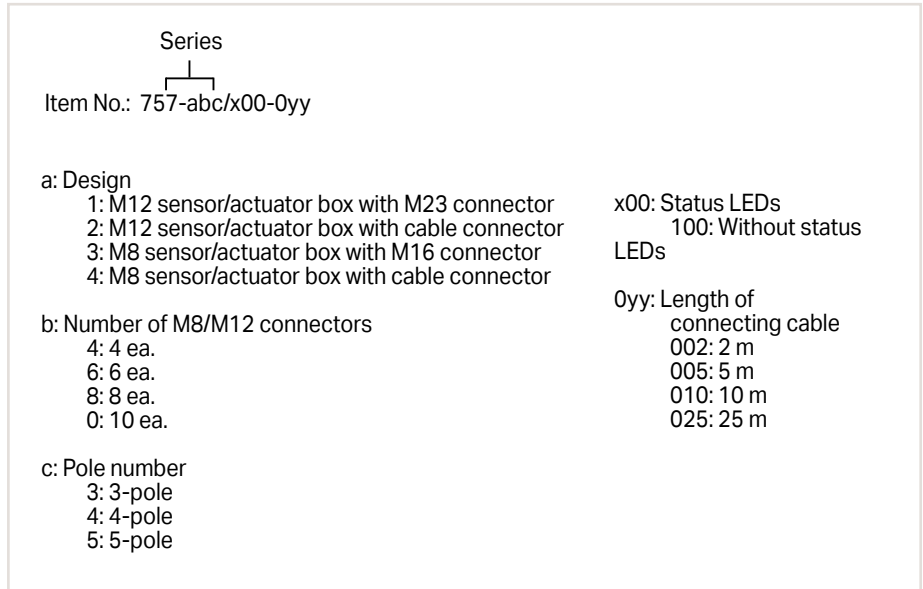
The sensor/actuator boxes can be mounted directly on the machine. Extensive engineering ensures compliance with standardized specifications from CNOMO guidelines regarding the spacing of assembly drill holes that are often used in passive distribution boxes or sensor/actuator boxes. An optional adapter is available that can be used to mount two modules seamlessly side by side. This has the advantage of maintaining a defined distance for proper routing of the sensor/actuator cables and of avoiding contamination points.

#### Advantages:

- Rugged, simple and compact extension for IP20 automation components
  - For stricter requirements on environmental conditions
  - For plug-and-play connector technology when needed
  - For simpler cable installation in the form of trunk cables
- High-quality PUR connection cables (drag chains compatible, halogen-free)
- Fully encapsulated (resistance and leak-proof)
- Flange sockets (metal design)
- Surrounding air temperature (operation): -25 ... +80°C
- Status LEDs

## Sensor/Actuator Boxes Item Number Key

Explanation of item number key's components



## Standards and Rated Conditions

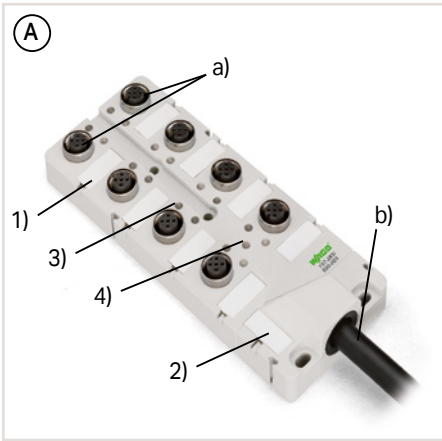
General Specifications	
<b>Electrical Data</b>	
Contact resistance (max.)	10 mΩ
Supply voltage	10 ... 30 VDC
Current carrying capacity (signal connections)	2 A
Current carrying capacity (supply connections)	9 A (M12) or 6 A (M8)
Signal characteristic	PNP
<b>Mechanical Data</b>	
Protection type	
Sensor/actuator boxes with cable connection	IP68 (72 hours at 1 m water depth)
Sensor/actuator boxes with M16/M23 connection	IP67
Surrounding air temperature (operation)	-25 ... +80 °C
Mounting	Screw mount
Mounting position	Any
Vibration resistance	5g per IEC 60068-2-6
Shock resistance	49g per IEC 60068-2-27
<b>Material Data</b>	
Housing material	PA 66 (UL 94 V0); RAL 7035; silicon and halogen free
Encapsulation	Fully encapsulated with conformal coating (UL 94 V0)
Connecting cable	Suitable for drag chains

## Approvals

Overview of the approvals in the item comparison in Section 11, Technical Section, or online at [www.wago.com](http://www.wago.com)



## Sensor/Actuator Boxes Interfaces and Types



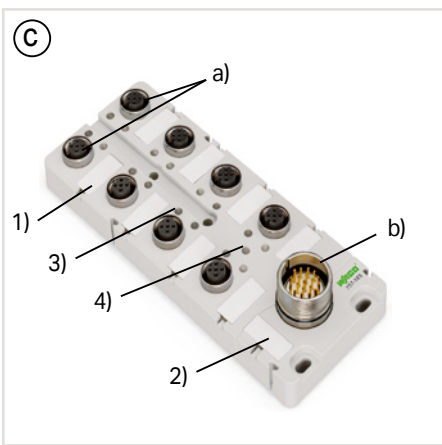
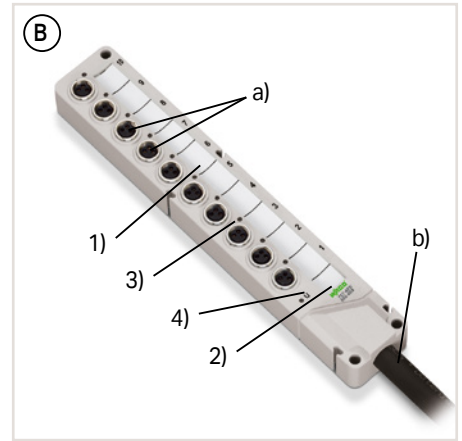
- (1) Sensor/actuator marking
- (2) Module marking
- (3) LED status indicator (by channel), yellow
- (4) LED operating indicator module, green

### Housing design (A)

- M12 sensor/actuator box with cable connection
- Sensor/actuator M12 sockets (a)
- Connection technology (trunk cable): Fixed connecting cable (b)

### Housing design (B)

- M8 sensor/actuator box with cable connection
- Sensor/actuator M8 sockets (a)
- Connection technology (trunk cable): Fixed connecting cable (b)

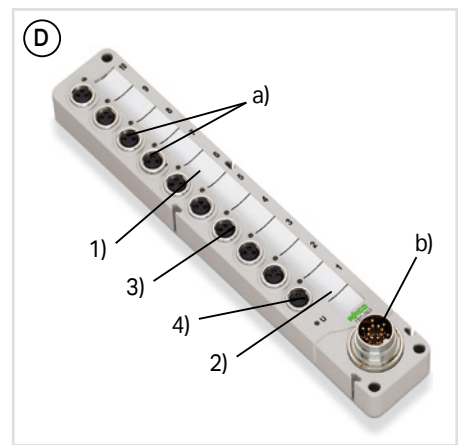


### Housing design (C)

- M12 sensor/actuator box with M23 connector
- Sensor/actuator connections M12 (a)
- Connection technology (trunk cable): M23 plug (b)

### Housing design (D)

- M8 sensor/actuator box with M16 connector
- Sensor/actuator connections M8 (a)
- Connection technology (trunk cable): M16 plug (b)

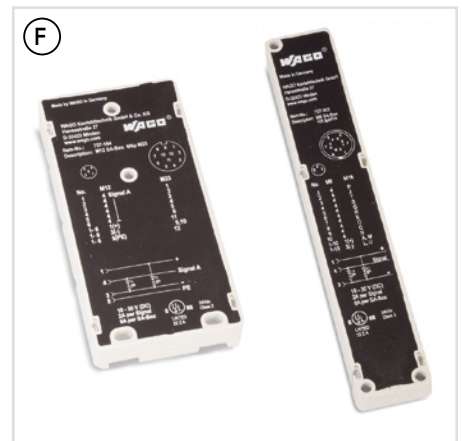


### Spacer module (E)

- Optional accessory
- For seamless assembly of two side-by-side sensor/actuator boxes
- Defined distance for proper cable connection
- Covers contamination points
- W x H x D (mm):
  - 10-way: 20 x 16 x 175
  - 8-way: 20 x 16 x 152
  - 6-way: 20 x 16 x 123
  - 4-way: 20 x 16 x 117

### Protection class (F)

- All modules are fully encapsulated
- IP67/68 protection class
- Printing on back of module details pin assignment

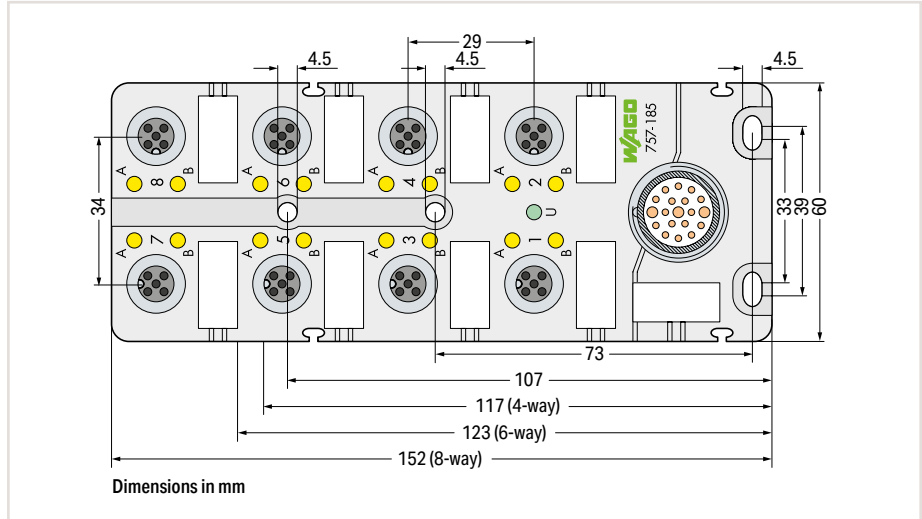




# Sensor/Actuator Boxes Interfaces and Types

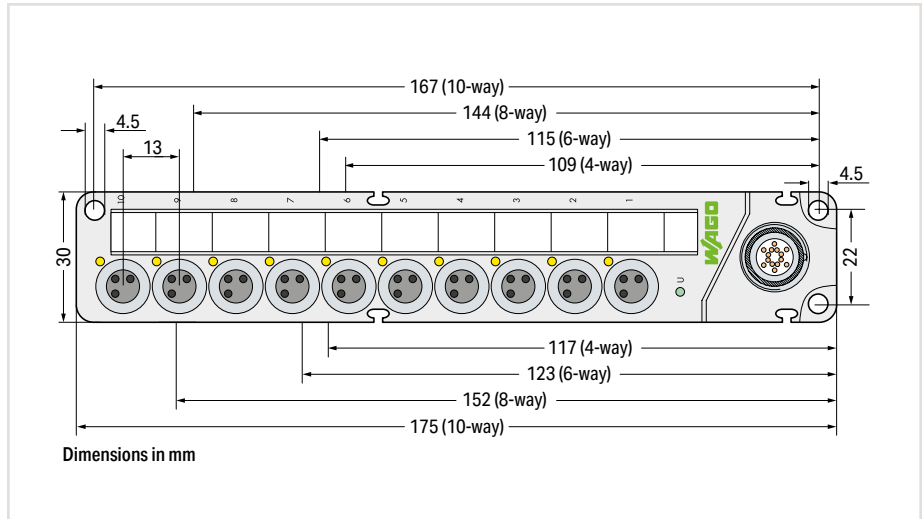
## Dimensions and Mounting Dimensions of M12 Sensor/Actuator Boxes

The dimensions also apply to M12 sensor/actuator boxes with cable connection.



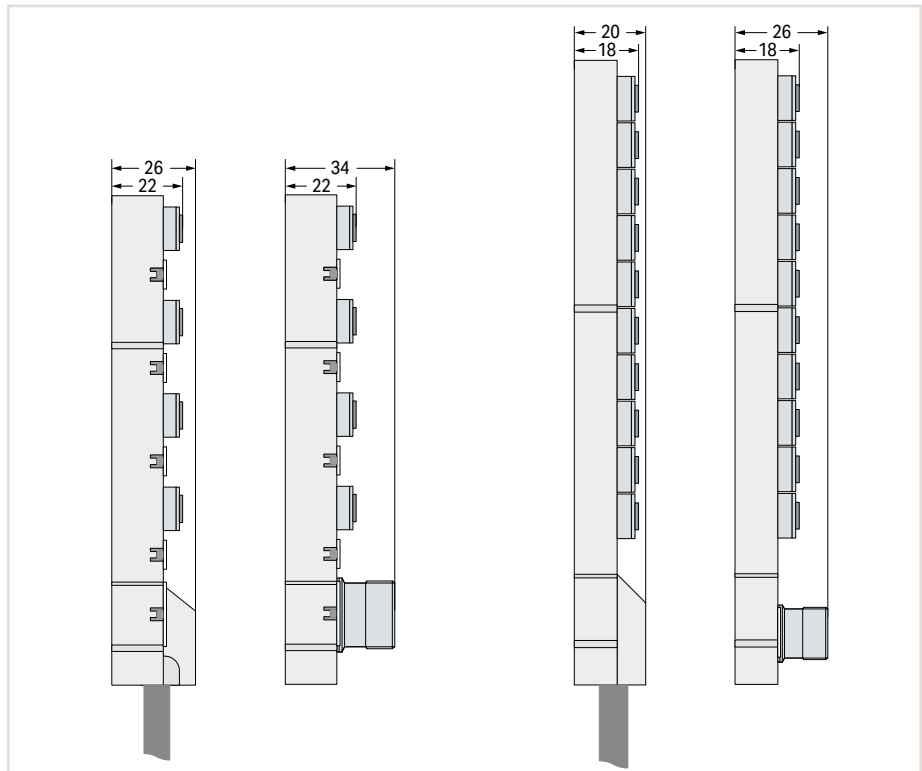
## Dimensions and Mounting Dimensions of M8 Sensor/Actuator Boxes

The dimensions also apply to M8 sensor/actuator boxes with cable connection.



### Dimensions:

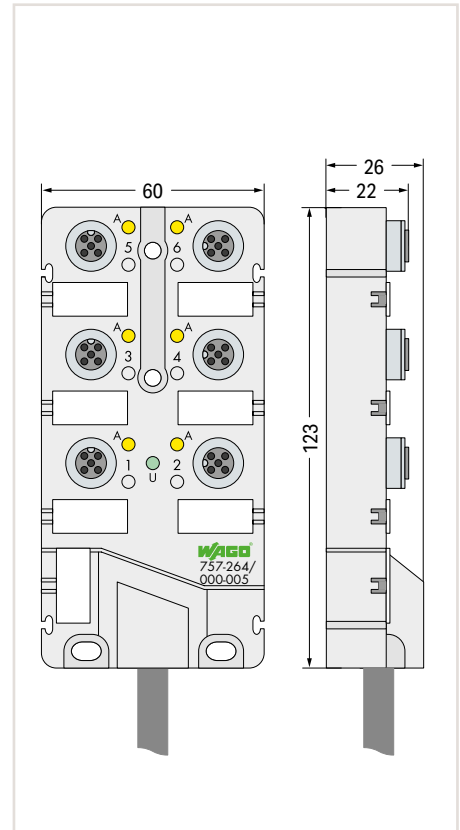
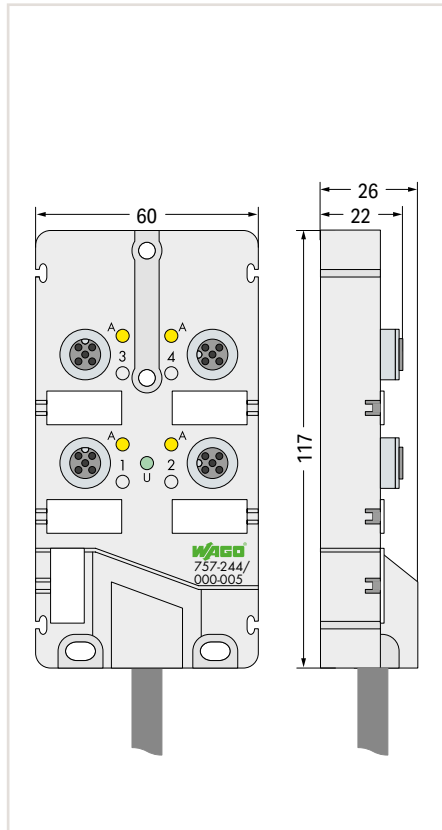
Depth of M12 sensor/actuator boxes or M8 sensor/actuator boxes



# M12 Sensor/Actuator Box; 4-Pole; With Connecting Cable



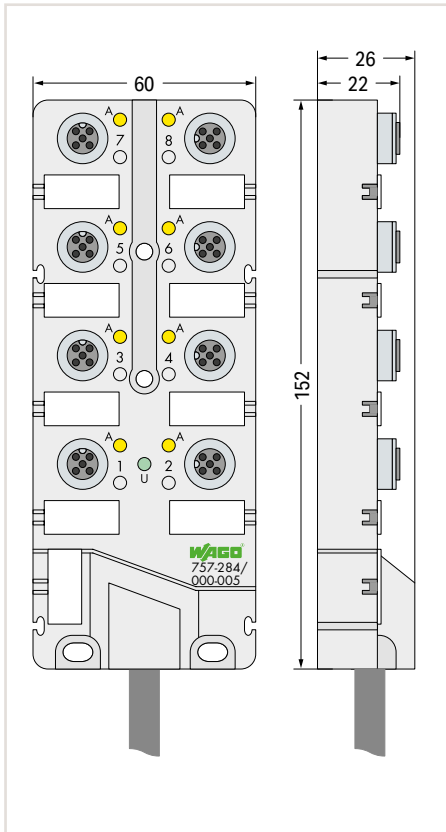
Figure: 757-284/000-005



Item Description	M12 Sensor/Actuator Box; 4-port; 4-pole		M12 Sensor/Actuator Box; 6-port; 4-pole	
Version	5 m connecting cable	10 m connecting cable	5 m connecting cable	10 m connecting cable
Item No.	757-244/000-005	757-244/000-010	757-264/000-005	757-264/000-010
Order Text	M12 S/A-Box; 4port; 4pole; 5m	M12 S/A-Box; 4port; 4pole; 10m	M12 S/A-Box; 6port; 4pole; 5m	M12 S/A-Box; 6port; 4pole; 10m
<b>Technical Data</b>				
Connection technology: inputs/outputs	4 x socket M12; 4-pole; including GND		6 x socket M12; 4-pole; including GND	
Number of poles	4 (1 signal per contact)		4 (1 signal per contact)	
Connection technology: trunk cable	Fixed connecting cable		Fixed connecting cable	
Length of connecting cable	5 m	10 m	5 m	10 m
Dimensions W x H x D	60 x 26 x 117 mm		60 x 26 x 123 mm	
<b>Approvals</b>	E 175199; Ⓢ UL 508; Class 2 Equipment These components are designed to be supplied through Class 2 power supplies per UL 1310 or Class 2 transformers per UL 1585.		E 175199; Ⓢ UL 508; Class 2 Equipment These components are designed to be supplied through Class 2 power supplies per UL 1310 or Class 2 transformers per UL 1585.	
<b>Data sheet and further information, see:</b>	<a href="http://wago.com/757-244">wago.com/757-244</a>		<a href="http://wago.com/757-264">wago.com/757-264</a>	
<b>Accessories</b>	<b>Item No.</b>	<b>Page</b>	<b>Item No.</b>	<b>Page</b>
Marker card	757-011	444	757-011	444
Felt-tip pen	210-110	444	210-110	444
Spacer module	757-040	444	757-060	444
M12 protective cap	756-8102	444	756-8102	444

„ IP67 cables and pluggable connectors, see Section "Accessories and Tools"

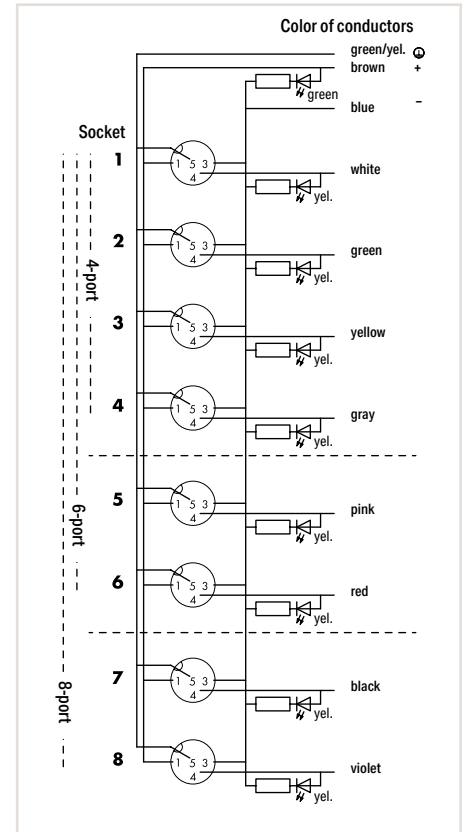
„ Approvals and corresponding ratings, see page 529 or www.wago.com



M12 Sensor/Actuator Box; 8-port; 4-pole		
5 m connecting cable	10 m connecting cable	25 m connecting cable
757-284/000-005	757-284/000-010	757-284/000-025
M12 S/A-Box; 8port; 4pole; 5m	M12 S/A-Box; 8port; 4pole; 10m	M12 S/A-Box; 8port; 4pole; 25m

8 x socket M12; 4-pole; including GND 4 (1 signal per contact)		
Fixed connecting cable		
5 m	10 m	25 m
60 x 26 x 152 mm		
E 175199; UL 508; Class 2 Equipment		
These components are designed to be supplied through Class 2 power supplies per UL 1310 or Class 2 transformers per UL 1585.		
<a href="http://wago.com/757-284">wago.com/757-284</a>		

Item No.	Page
757-011	444
210-110	444
757-080	444
756-8102	444

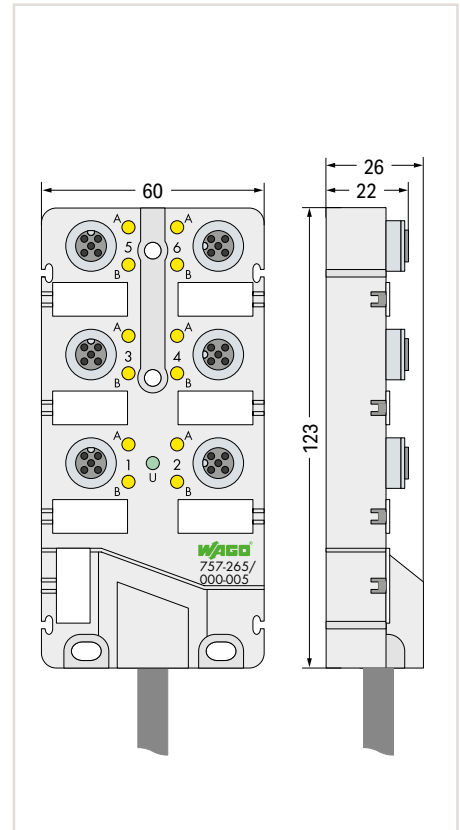
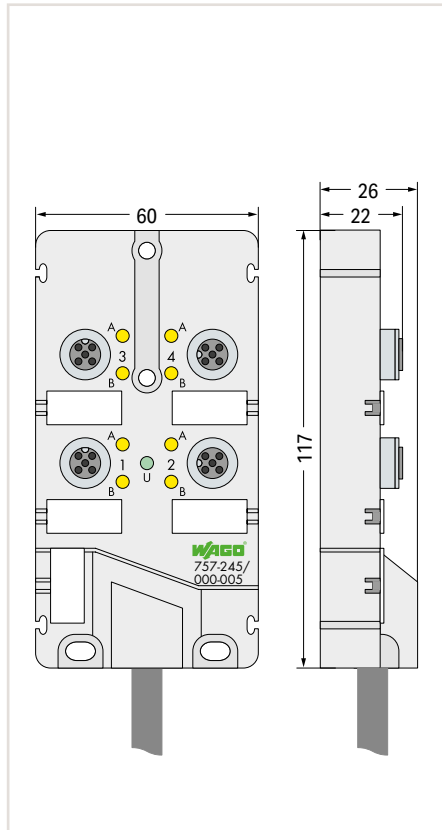


Circuit Diagram: Sensor/Actuator Box; 4-Pole

# M12 Sensor/Actuator Box; 5-Pole; With Connecting Cable



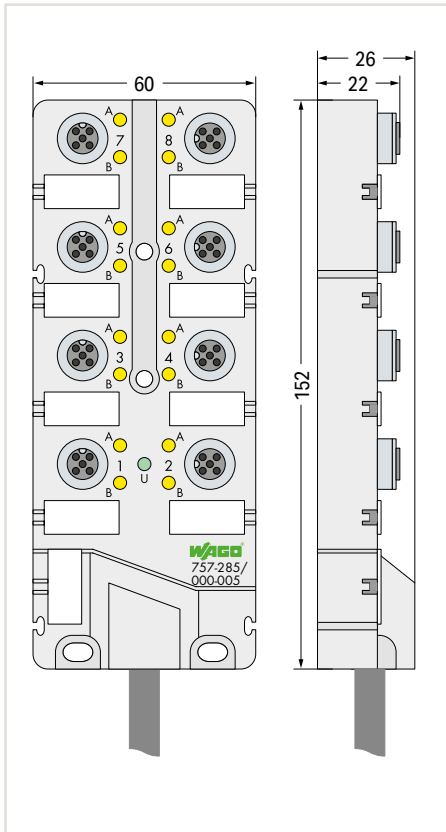
Figure: 757-285/000-005



Item Description	M12 Sensor/Actuator Box; 4-port; 5-pole		M12 Sensor/Actuator Box; 6-port; 5-pole	
Version	5 m connecting cable	10 m connecting cable	5 m connecting cable	10 m connecting cable
Item No.	757-245/000-005	757-245/000-010	757-265/000-005	757-265/000-010
Order Text	M12 S/A-Box; 4port; 5pole; 5m	M12 S/A-Box; 4port; 5pole; 10m	M12 S/A-Box; 6port; 5pole; 5m	M12 S/A-Box; 6port; 5pole; 10m
<b>Technical Data</b>				
Connection technology: inputs/outputs	4 x socket M12; 5-pole; including GND		6 x socket M12; 5-pole; including GND	
Number of poles	5 (2 signals per contact)		5 (2 signals per contact)	
Connection technology: trunk cable	Fixed connecting cable		Fixed connecting cable	
Length of connecting cable	5 m	10 m	5 m	10 m
Dimensions W x H x D	60 x 26 x 117 mm		60 x 26 x 123 mm	
<b>Approvals</b>	E 175199; Ⓢ UL 508; Class 2 Equipment These components are designed to be supplied through Class 2 power supplies per UL 1310 or Class 2 transformers per UL 1585.		E 175199; Ⓢ UL 508; Class 2 Equipment These components are designed to be supplied through Class 2 power supplies per UL 1310 or Class 2 transformers per UL 1585.	
Data sheet and further information, see:	<a href="http://wago.com/757-245">wago.com/757-245</a>		<a href="http://wago.com/757-265">wago.com/757-265</a>	
<b>Accessories</b>	<b>Item No.</b>	<b>Page</b>	<b>Item No.</b>	<b>Page</b>
Marker card	757-011	444	757-011	444
Felt-tip pen	210-110	444	210-110	444
Spacer module	757-040	444	757-060	444
M12 protective cap	756-8102	444	756-8102	444

„ IP67 cables and pluggable connectors, see Section "Accessories and Tools"

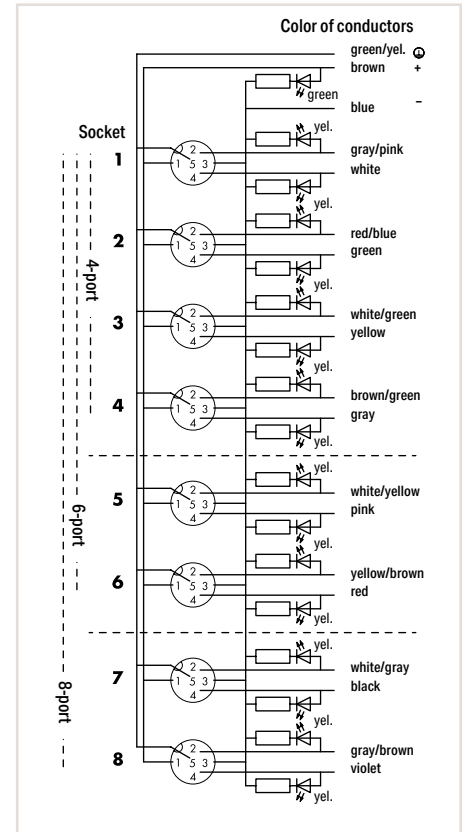
„ Approvals and corresponding ratings, see page 529 or www.wago.com



M12 Sensor/Actuator Box; 8-port; 5-pole		
5 m connecting cable	10 m connecting cable	25 m connecting cable
757-285/000-005	757-285/000-010	757-285/000-025
M12 S/A-Box; 8port; 5pole; 5m	M12 S/A-Box; 8port; 5pole; 10m	M12 S/A-Box; 8port; 5pole; 25m

8 x socket M12; 5-pole; including GND 5 (2 signals per contact)		
Fixed connecting cable		
5 m	10 m	25 m
60 x 26 x 152 mm		
E 175199; UL 508; Class 2 Equipment		
These components are designed to be supplied through Class 2 power supplies per UL 1310 or Class 2 transformers per UL 1585.		
<a href="http://wago.com/757-285">wago.com/757-285</a>		

Item No.	Page
757-011	444
210-110	444
757-080	444
756-8102	444

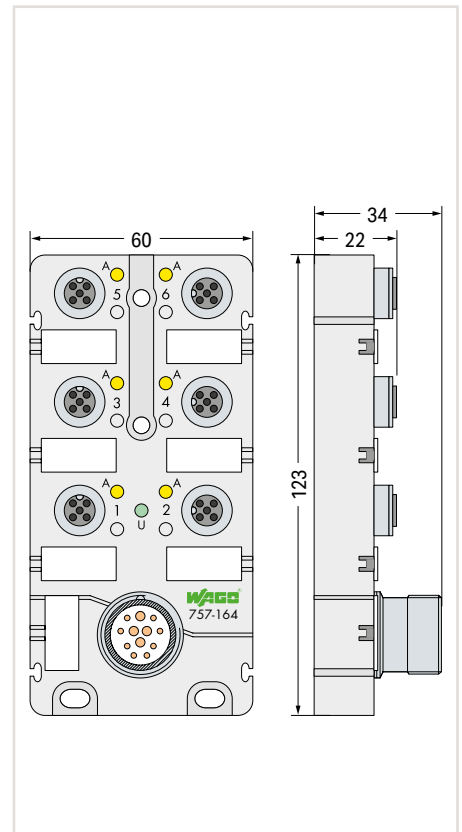
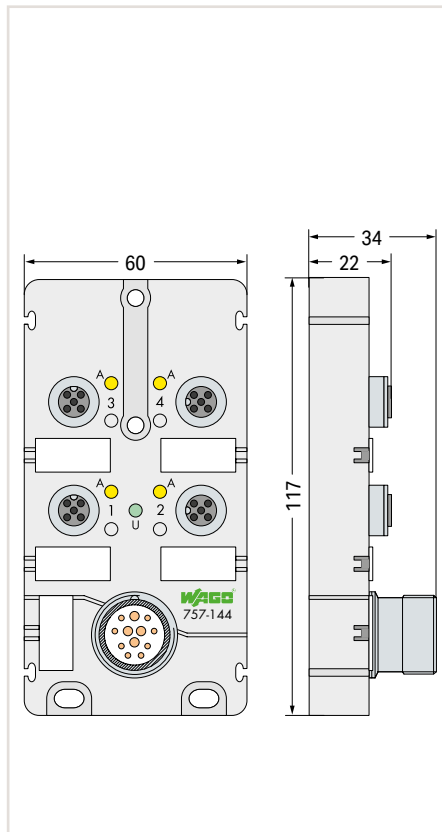


Circuit Diagram: Sensor/Actuator Box; 5-Pole

# M12 Sensor/Actuator Box; 4-Pole; With M23 Connector



Figure: 757-184

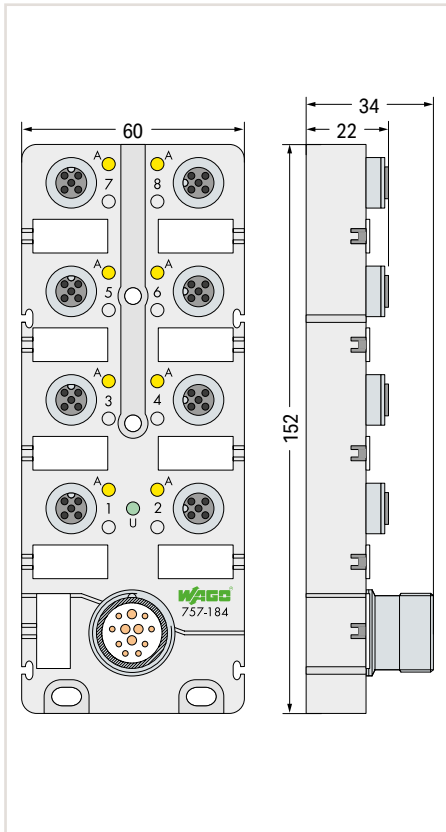


Item Description	M12 Sensor/Actuator Box; 4-port; 4-pole; M23 connector	M12 Sensor/Actuator Box; 6-port; 4-pole; M23 connector																				
Item No.	757-144	757-164																				
Order Text	M12 S/A-Box; 4port; 4pole; M23	M12 S/A-Box; 6port; 4pole; M23																				
<b>Technical Data</b>																						
Connection technology: inputs/outputs	4 x socket M12; 4-pole; including GND	6 x socket M12; 4-pole; including GND																				
Number of poles	4 (1 signal per contact)	4 (1 signal per contact)																				
Connection technology: trunk cable	M23 plug; 12-pole	M23 plug; 12-pole																				
Dimensions W x H x D	60 x 34 x 117 mm	60 x 34 x 123 mm																				
<b>Approvals</b>	E 175199; Ⓢ UL 508; Class 2 Equipment These components are designed to be supplied through Class 2 power supplies per UL 1310 or Class 2 transformers per UL 1585.	E 175199; Ⓢ UL 508; Class 2 Equipment These components are designed to be supplied through Class 2 power supplies per UL 1310 or Class 2 transformers per UL 1585.																				
<b>Data sheet and further information, see:</b>	<a href="http://wago.com/757-144">wago.com/757-144</a>	<a href="http://wago.com/757-164">wago.com/757-164</a>																				
<b>Accessories</b>	<table border="1"> <thead> <tr> <th>Item No.</th> <th>Page</th> </tr> </thead> <tbody> <tr> <td>757-011</td> <td>444</td> </tr> <tr> <td>210-110</td> <td>444</td> </tr> <tr> <td>757-040</td> <td>444</td> </tr> <tr> <td>756-8102</td> <td>444</td> </tr> </tbody> </table>	Item No.	Page	757-011	444	210-110	444	757-040	444	756-8102	444	<table border="1"> <thead> <tr> <th>Item No.</th> <th>Page</th> </tr> </thead> <tbody> <tr> <td>757-011</td> <td>444</td> </tr> <tr> <td>210-110</td> <td>444</td> </tr> <tr> <td>757-060</td> <td>444</td> </tr> <tr> <td>756-8102</td> <td>444</td> </tr> </tbody> </table>	Item No.	Page	757-011	444	210-110	444	757-060	444	756-8102	444
Item No.	Page																					
757-011	444																					
210-110	444																					
757-040	444																					
756-8102	444																					
Item No.	Page																					
757-011	444																					
210-110	444																					
757-060	444																					
756-8102	444																					

„ Interconnecting cables, M23 socket, see page 445

„ IP67 cables and pluggable connectors, see Section "Accessories and Tools"

„ Approvals and corresponding ratings, see page 529 or www.wago.com



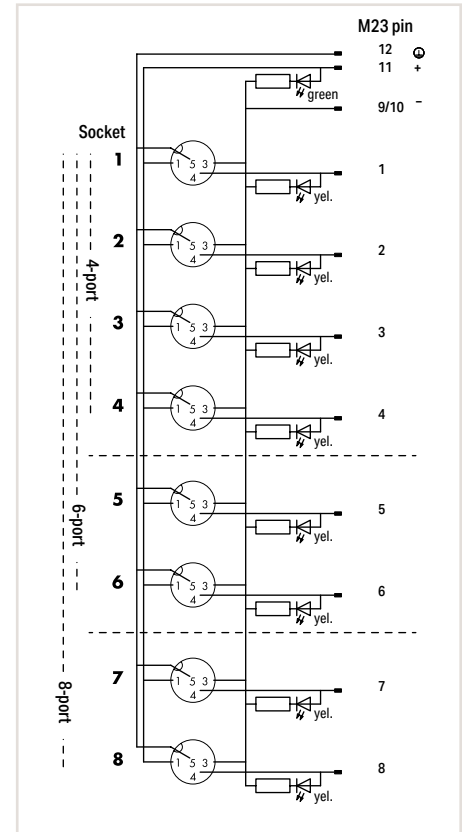
**M12 Sensor/Actuator Box; 6-port; 4-pole; M23 connector**

757-184

M12 S/A-Box; 8port; 4pole; M23

8 x socket M12; 4-pole; including GND 4 (1 signal per contact)
M23 plug; 12-pole 60 x 34 x 152 mm
E 175199; UL 508; Class 2 Equipment These components are designed to be supplied through Class 2 power supplies per UL 1310 or Class 2 transformers per UL 1585. <a href="http://wago.com/757-184">wago.com/757-184</a>

Item No.	Page
757-011	444
210-110	444
757-080	444
756-8102	444

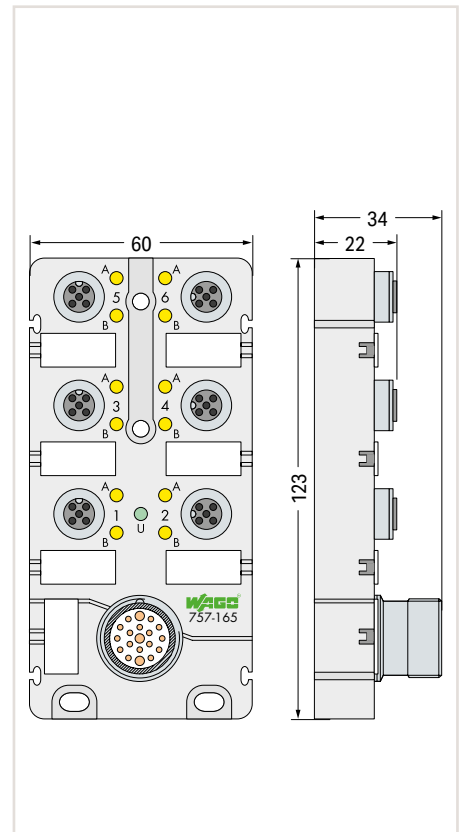
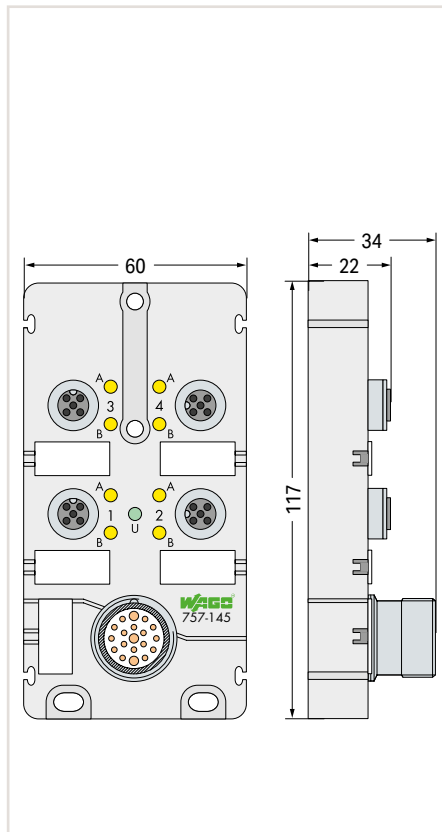


Circuit Diagram: Sensor/Actuator Box; 4-Pole

# M12 Sensor/Actuator Box; 5-Pole; With M23 Connector



Figure: 757-185



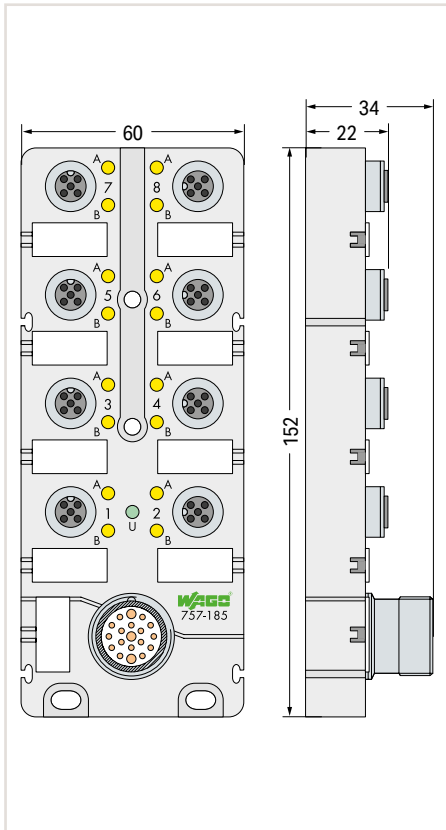
Item Description	M12 Sensor/Actuator Box; 4-port; 5-pole; M23 connector	M12 Sensor/Actuator Box; 6-port; 5-pole; M23 connector																				
Version																						
Item No.	757-145	757-165																				
Order Text	M12 S/A-Box; 4port; 5pole; M23	M12 S/A-Box; 6port; 5pole; M23																				
Technical Data																						
Connection technology: inputs/outputs	4 x socket M12; 5-pole; including GND	6 x socket M12; 5-pole; including GND																				
Number of poles	5 (2 signals per contact)	5 (2 signals per contact)																				
Connection technology: trunk cable	M23 plug; 19-pole	M23 plug; 19-pole																				
Dimensions W x H x D	60 x 34 x 117 mm	60 x 34 x 123 mm																				
Approvals	E 175199; Ⓢ UL 508; Class 2 Equipment These components are designed to be supplied through Class 2 power supplies per UL 1310 or Class 2 transformers per UL 1585.	E 175199; Ⓢ UL 508; Class 2 Equipment These components are designed to be supplied through Class 2 power supplies per UL 1310 or Class 2 transformers per UL 1585.																				
Data sheet and further information, see:	<a href="http://wago.com/757-145">wago.com/757-145</a>	<a href="http://wago.com/757-165">wago.com/757-165</a>																				
Accessories	<table border="1"> <thead> <tr> <th>Item No.</th> <th>Page</th> </tr> </thead> <tbody> <tr> <td>757-011</td> <td>444</td> </tr> <tr> <td>210-110</td> <td>444</td> </tr> <tr> <td>757-040</td> <td>444</td> </tr> <tr> <td>756-8102</td> <td>444</td> </tr> </tbody> </table>	Item No.	Page	757-011	444	210-110	444	757-040	444	756-8102	444	<table border="1"> <thead> <tr> <th>Item No.</th> <th>Page</th> </tr> </thead> <tbody> <tr> <td>757-011</td> <td>444</td> </tr> <tr> <td>210-110</td> <td>444</td> </tr> <tr> <td>757-060</td> <td>444</td> </tr> <tr> <td>756-8102</td> <td>444</td> </tr> </tbody> </table>	Item No.	Page	757-011	444	210-110	444	757-060	444	756-8102	444
Item No.	Page																					
757-011	444																					
210-110	444																					
757-040	444																					
756-8102	444																					
Item No.	Page																					
757-011	444																					
210-110	444																					
757-060	444																					
756-8102	444																					

„ Interconnecting cables, M23 socket, see page 445

„ IP67 cables and pluggable connectors, see Section "Accessories and Tools"

„ Approvals and corresponding ratings, see page 529 or [www.wago.com](http://www.wago.com)





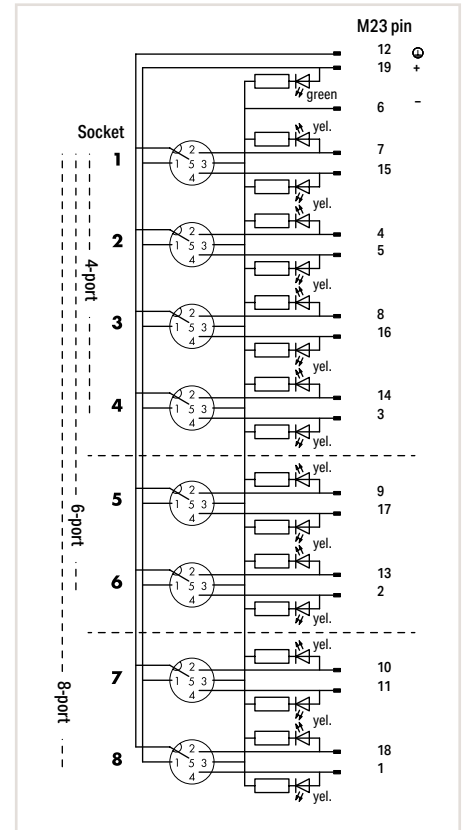
**M12 Sensor/Actuator Box; 8-port; 5-pole; M23 connector**

	<b>without LED</b>
757-185	757-185/100-000
M12 S/A-Box; 8port; 5pole; M23	M12 S/A-Box; 8port; 5pole; M23; NL

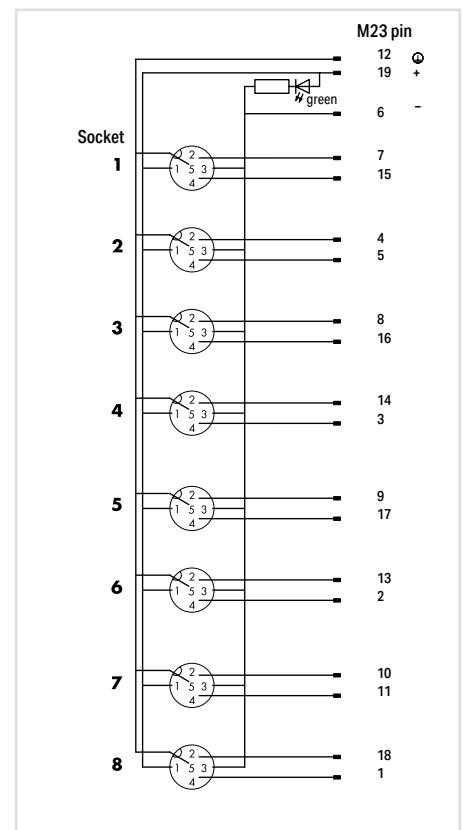
8 x socket M12; 5-pole; including GND 5 (2 signals per contact)	
M23 plug; 19-pole 60 x 34 x 152 mm	
E 175199; UL 508; Class 2 Equipment These components are designed to be supplied through Class 2 power supplies per UL 1310 or Class 2 transformers per UL 1585.	
<a href="http://wago.com/757-185">wago.com/757-185</a>	<a href="http://wago.com/757-185/100-000">wago.com/757-185/100-000</a>

Item No.	Page
757-011	444
210-110	444
757-080	444
756-8102	444

The 757-185/100-000 Module has no status LEDs and can therefore also transmit analog signals!



Circuit Diagram: Sensor/Actuator Box; 5-Pole

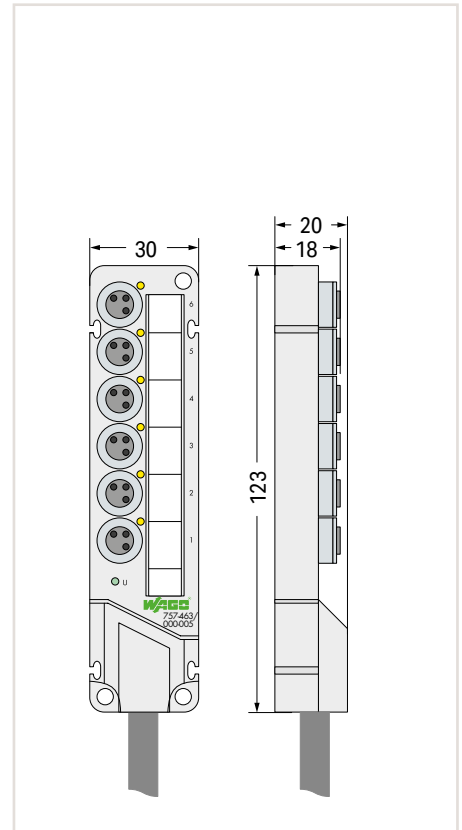
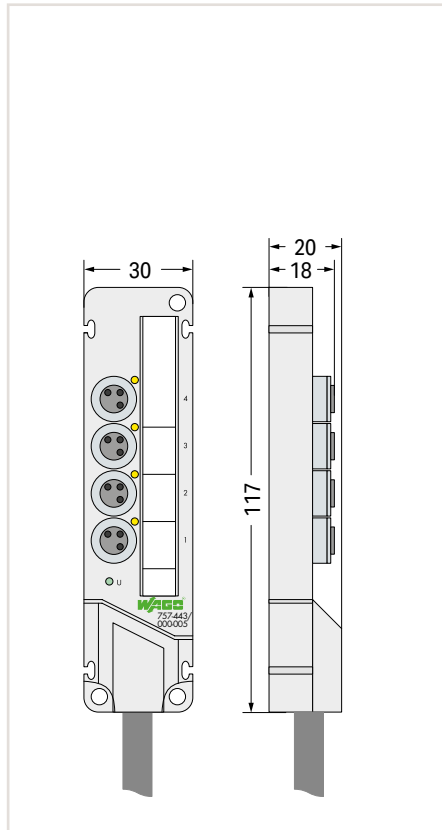


Circuit Diagram: Sensor/Actuator Box; 5-Pole; without LED

# M8 Sensor/Actuator Box; 3-Pole; With Connecting Cable



Figure: 757-403/000-005

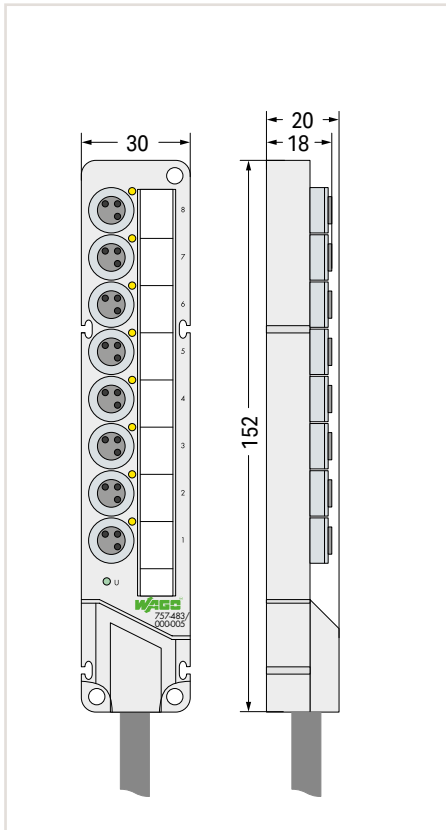


Item Description	M8 Sensor/Actuator Box; 4-port; 3-pole			M8 Sensor/Actuator Box; 6-port; 3-pole	
Version	2 m connecting cable	5 m connecting cable	10 m connecting cable	5 m connecting cable	10 m connecting cable
Item No.	757-443/000-002	757-443/000-005	757-443/000-010	757-463/000-005	757-463/000-010
Order Text	M8 S/A-Box; 4port; 3pole; 2m	M8 S/A-Box; 4port; 3pole; 5m	M8 S/A-Box; 4port; 3pole; 10m	M8 S/A-Box; 6port; 3pole; 5m	M8 S/A-Box; 6port; 3pole; 10m

Technical Data	M8 Sensor/Actuator Box; 4-port; 3-pole			M8 Sensor/Actuator Box; 6-port; 3-pole	
Connection technology: inputs/outputs	4 x M8 socket; 3-pole			6 x M8 socket; 3-pole	
Number of poles	3 (1 signal per contact)			3 (1 signal per contact)	
Connection technology: trunk cable	Fixed connecting cable			Fixed connecting cable	
Length of connecting cable	2 m	5 m	10 m	5 m	10 m
Dimensions W x H x D	30 x 20 x 117 mm			30 x 20 x 123 mm	
Approvals	E 175199; Ⓢ UL 508; Class 2 Equipment These components are designed to be supplied through Class 2 power supplies per UL 1310 or Class 2 transformers per UL 1585.			E 175199; Ⓢ UL 508; Class 2 Equipment These components are designed to be supplied through Class 2 power supplies per UL 1310 or Class 2 transformers per UL 1585.	
Data sheet and further information, see:	<a href="http://wago.com/757-443">wago.com/757-443</a>			<a href="http://wago.com/757-463">wago.com/757-463</a>	

Accessories	Item No.	Page	Item No.	Page
Marking strip	757-041	444	757-061	444
Felt-tip pen	210-110	444	210-110	444
Spacer module	757-040	444	757-060	444
M8 protective cap	756-8101	444	756-8101	444

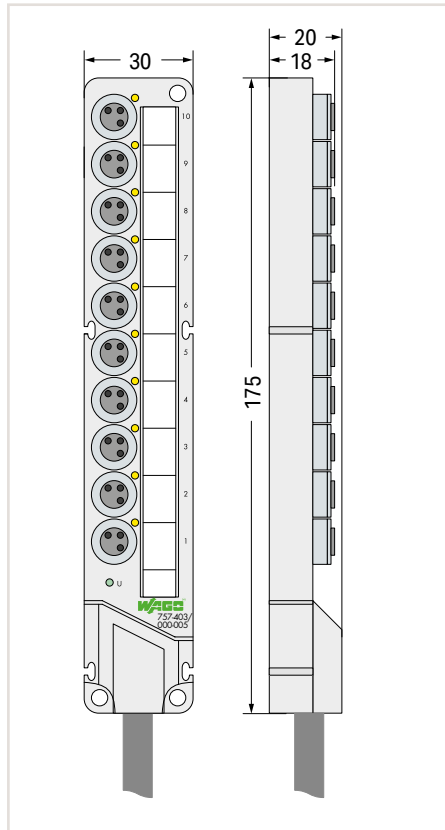
„ IP67 cables and pluggable connectors, see Section "Accessories and Tools"  
 „ Approvals and corresponding ratings, see page 529 or [www.wago.com](http://www.wago.com)



M8 Sensor/Actuator Box; 8-port; 3-pole	
5 m connecting cable	10 m connecting cable
757-483/000-005	757-483/000-010
M8 S/A-Box; 8port; 3pole; 5m	M8 S/A-Box; 8port; 3pole; 10m

8 x M8 socket; 3-pole	
3 (1 signal per contact)	
Fixed connecting cable	
5 m	10 m
30 x 20 x 152 mm	
E 175199; Ⓢ UL 508; Class 2 Equipment	
These components are designed to be supplied through Class 2 power supplies per UL 1310 or Class 2 transformers per UL 1585.	
<a href="http://wago.com/757-483">wago.com/757-483</a>	

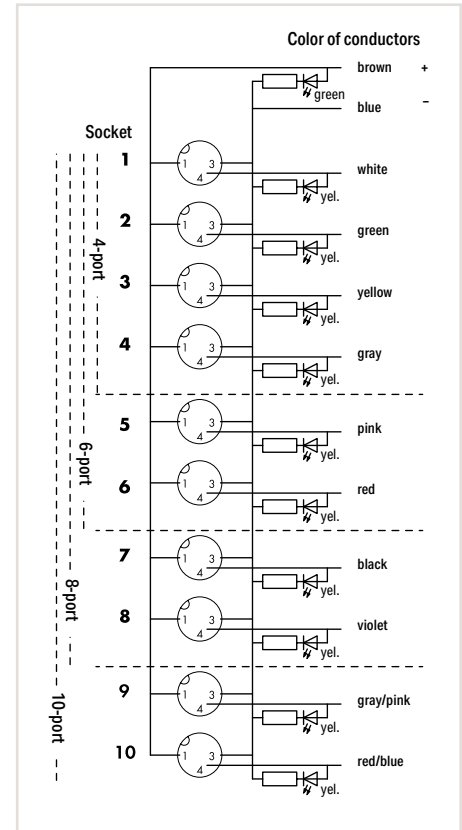
Item No.	Page
757-081	444
210-110	444
757-080	444
756-8101	444



M8 Sensor/Actuator Box; 10-port; 3-pole	
5 m connecting cable	10 m connecting cable
757-403/000-005	757-403/000-010
M8 S/A-Box; 10port; 3pole; 5m	M8 S/A-Box; 10port; 3pole; 10m

10 x M8 socket; 3-pole	
3 (1 signal per contact)	
Fixed connecting cable	
5 m	10 m
30 x 20 x 175 mm	
E 175199; Ⓢ UL 508; Class 2 Equipment	
These components are designed to be supplied through Class 2 power supplies per UL 1310 or Class 2 transformers per UL 1585.	
<a href="http://wago.com/757-403">wago.com/757-403</a>	

Item No.	Page
757-001	444
210-110	444
757-000	444
756-8101	444

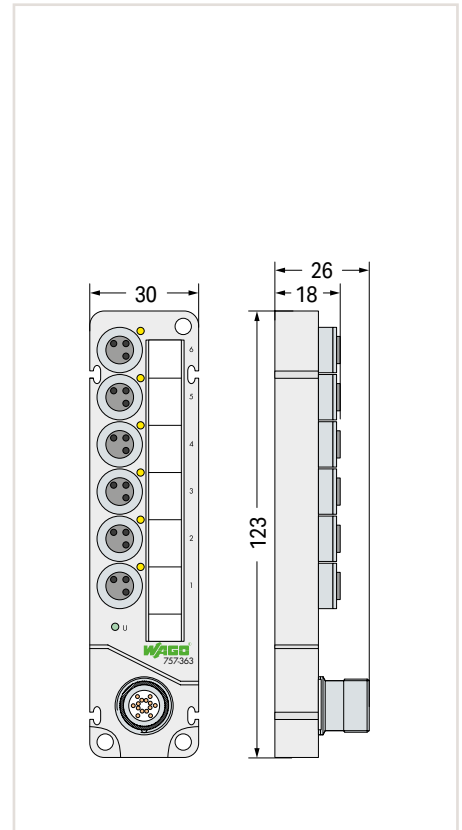
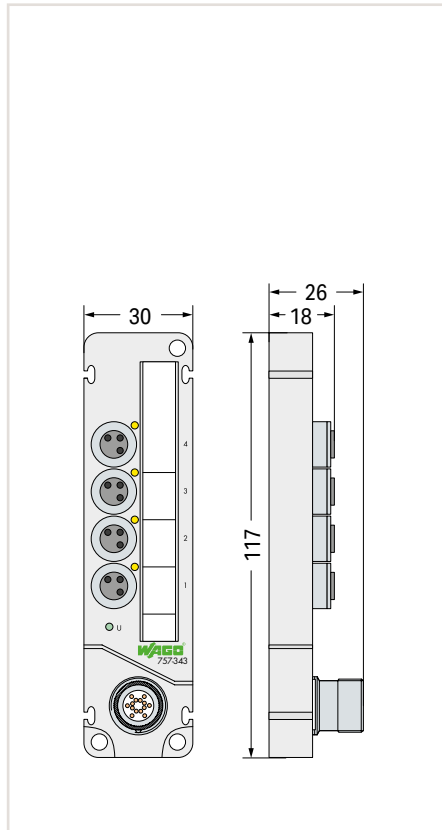


Circuit Diagram: Sensor/Actuator Box; 3-Pole

## M8 Sensor/Actuator Box; 3-Pole; With M16 Connector



Figure: 757-303

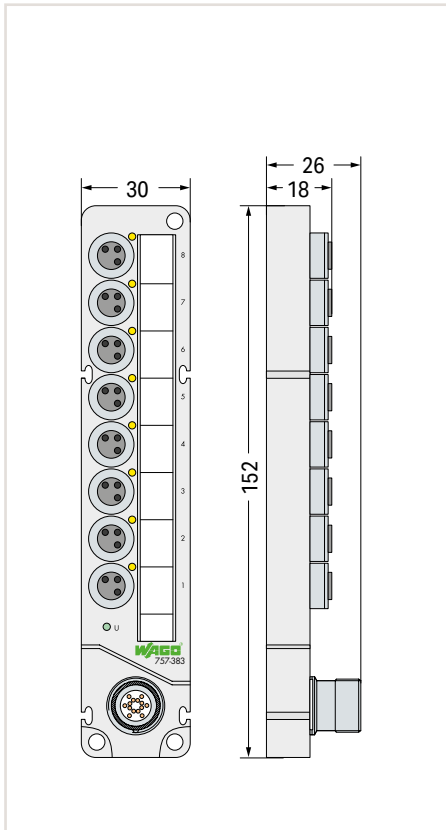


Item Description	M8 Sensor/Actuator Box; 4-port; 3-pole; M16 connector	M8 Sensor/Actuator Box; 6-port; 3-pole; M16 connector
Item No.	757-343	757-363
Order Text	M8 S/A-Box; 4port; 3pole; M16	M8 S/A-Box; 6port; 3pole; M16
<b>Technical Data</b>		
Connection technology: inputs/outputs	4 x M8 socket; 3-pole	6 x M8 socket; 3-pole
Number of poles	3 (1 signal per contact)	3 (1 signal per contact)
Connection technology: trunk cable	M16 plug; 14-pole	M16 plug; 14-pole
Dimensions W x H x D	30 x 26 x 117 mm	30 x 26 x 123 mm
<b>Approvals</b>	E 175199;  UL 508; Class 2 Equipment These components are designed to be supplied through Class 2 power supplies per UL 1310 or Class 2 transformers per UL 1585.	E 175199;  UL 508; Class 2 Equipment These components are designed to be supplied through Class 2 power supplies per UL 1310 or Class 2 transformers per UL 1585.
Data sheet and further information, see:	<a href="http://wago.com/757-343">wago.com/757-343</a>	<a href="http://wago.com/757-363">wago.com/757-363</a>
<b>Accessories</b>		
Marking strip	Item No. 757-041 Page 444	Item No. 757-061 Page 444
Felt-tip pen	Item No. 210-110 Page 444	Item No. 210-110 Page 444
Spacer module	Item No. 757-040 Page 444	Item No. 757-060 Page 444
M8 protective cap	Item No. 756-8101 Page 444	Item No. 756-8101 Page 444

„ Interconnecting cables, M16 socket, see page 445

„ IP67 cables and pluggable connectors, see Section "Accessories and Tools"

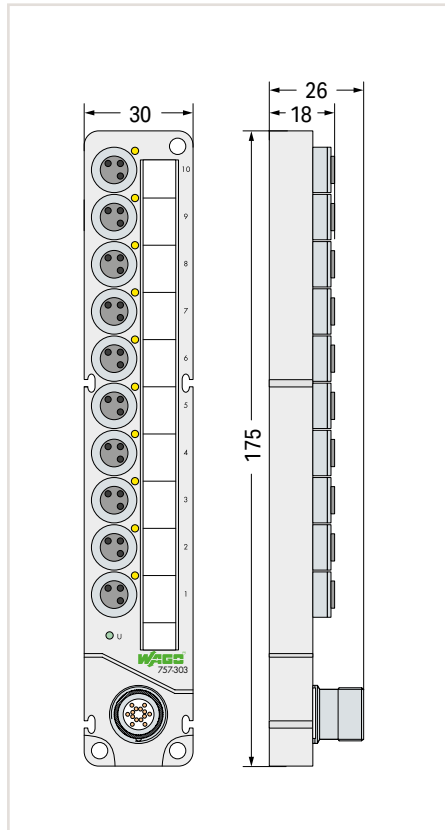
„ Approvals and corresponding ratings, see page 529 or [www.wago.com](http://www.wago.com)



**M8 Sensor/Actuator Box; 8-port; 3-pole; M16 connector**  
**757-383**  
 M8 S/A-Box; 8port; 3pole; M16

8 x M8 socket; 3-pole 3 (1 signal per contact)
M16 plug; 14-pole 30 x 26 x 152 mm
E 175199; UL 508; Class 2 Equipment These components are designed to be supplied through Class 2 power supplies per UL 1310 or Class 2 transformers per UL 1585. <a href="http://wago.com/757-383">wago.com/757-383</a>

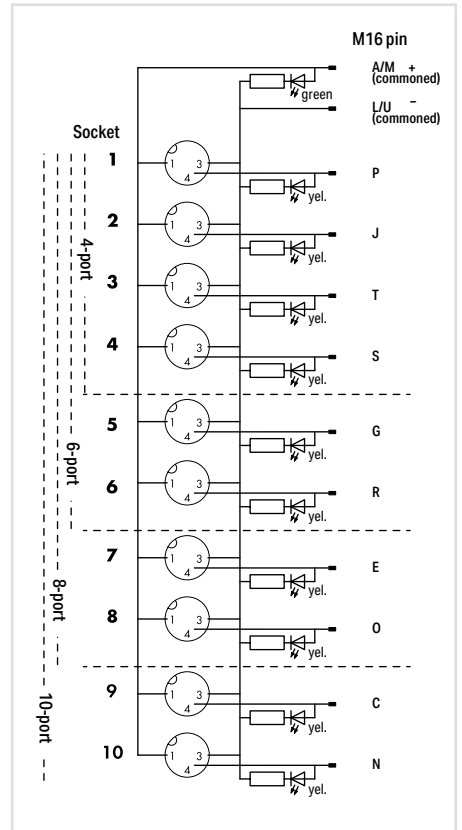
Item No.	Page
757-081	444
210-110	444
757-080	444
756-8101	444



**M8 Sensor/Actuator Box; 10-port; 3-pole; M16 connector**  
**757-303**  
 M8 S/A-Box; 10port; 3pole; M16

10 x M8 socket; 3-pole 3 (1 signal per contact)
M16 plug; 14-pole 30 x 26 x 175 mm
E 175199; UL 508; Class 2 Equipment These components are designed to be supplied through Class 2 power supplies per UL 1310 or Class 2 transformers per UL 1585. <a href="http://wago.com/757-303">wago.com/757-303</a>

Item No.	Page
757-001	444
210-110	444
757-000	444
756-8101	444



Circuit Diagram: Sensor/Actuator Box; 3-Pole

## Sensor/Actuator Boxes; Accessories



Marker card; not stretchable; snap-on type		
	Item No.	Pack. Unit
for M12 Sensor/Actuator Box	757-011	1



Marking strip; cut to defined length; not stretchable; plain; snap-on type		
for M8 Sensor/Actuator Box	Item No.	Pack. Unit
4-port	757-041	100
6-port	757-061	100
8-port	757-081	100
10-port	757-001	100



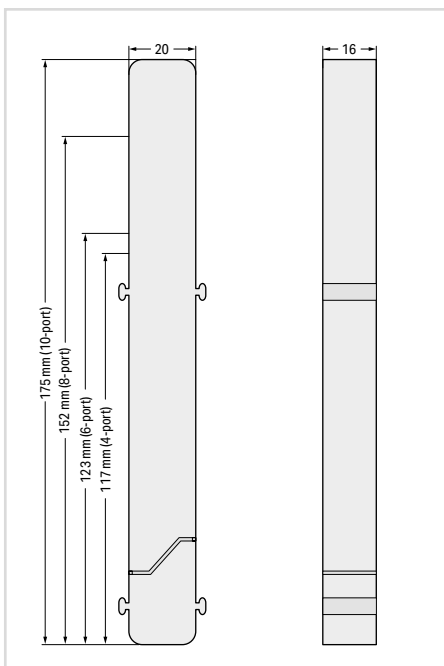
Felt-tip pen		
	Item No.	Pack. Unit
for permanent marking	210-110	1




Protective cap (for covering unused sensor/actuator ports)		
	Item No.	Pack. Unit
M8 protective cap	756-8101	10
M12 protective cap	756-8102	10



Spacer module for sensor/actuator box		
	Item No.	Pack. Unit
4-port	757-040	10
6-port	757-060	10
8-port	757-080	10
10-port	757-000	10


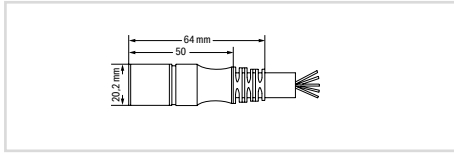
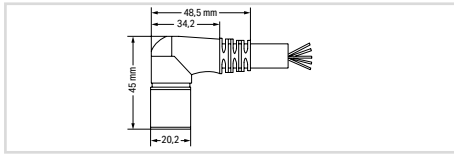




14-pole

Pin A, L: 0.75 mm<sup>2</sup>  
Pin C ... J, N ... T: 0.34 mm<sup>2</sup>

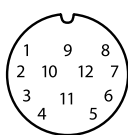
A	brown	N	pink-brown
C	white-pink	O	violet
E	black	P	white
G	rose	R	red
J	green	S	gray
L	blue	T	yellow
M	bridged with A	U	bridged with L

Operating voltage	150 V
Operating current	6 A (0.75 mm <sup>2</sup> ); 4 A (0.34 mm <sup>2</sup> )
Rated surge voltage	1.2 kV
Drag chain suitability	≥ 2 million bending cycles
Surrounding air temperature (operation), dynamic	-30 ... +90 °C
Protection type	IP67
Cable diameter	9.1 mm ±0.2

Interconnecting cable; 14-pole; M16 socket (straight)		
Cable Length	Item No.	Pack. Unit
5 m	756-3205/140-050	1
10 m	756-3205/140-100	1
15 m	756-3205/140-150	1


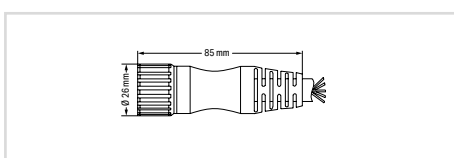
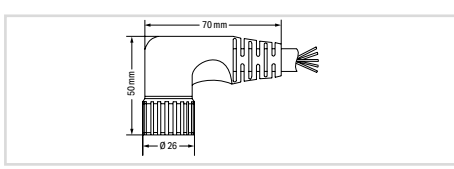
Interconnecting cable; 14-pole; M16 socket (angled)		
Cable Length	Item No.	Pack. Unit
5 m	756-3206/140-050	1
10 m	756-3206/140-100	1
15 m	756-3206/140-150	1



12-pole

Pin 9, 11, 12: 1.00 mm<sup>2</sup>;  
Pin 1 ... 8: 0.34 mm<sup>2</sup>

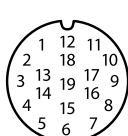
1	white	9	blue
2	green	10	bridged with 9
3	yellow	11	brown
4	gray	12	green-yellow
5	rose		
6	red		
7	black		
8	violet		

Operating voltage (max.)	300 V
Operating current	8 A
Rated surge voltage	≥ 2.0 kV rms
Drag chain suitability	≥ 2 million bending cycles
Surrounding air temperature (operation), dynamic	-25 ... +80 °C
Protection type	IP67
Cable diameter	9.3 mm ±0.3

Interconnecting cable; 12-pole; M23 socket (straight)		
Cable Length	Item No.	Pack. Unit
5 m	756-3201/120-050	1
10 m	756-3201/120-100	1
15 m	756-3201/120-150	1


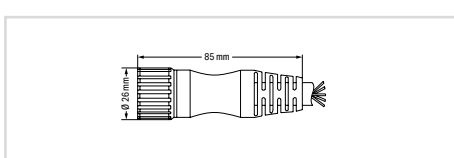
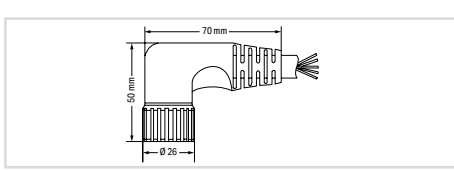
Interconnecting cable; 12-pole; M23 socket (angled)		
Cable Length	Item No.	Pack. Unit
5 m	756-3202/120-050	1
10 m	756-3202/120-100	1
15 m	756-3202/120-150	1



19-pole

Pin 6, 12, 19: 1.00 mm<sup>2</sup>;  
Pin 1 ... 5, 7 ... 11, 13 ... 19: 0.34 mm<sup>2</sup>

1	violet	11	black
2	red	12	green-yellow
3	gray	13	yellow-brown
4	red-blue	14	brown-green
5	green	15	white
6	blue	16	yellow
7	gray-pink	17	rose
8	white-green	18	gray-brown
9	white-yellow	19	brown
10	white-gray		

Operating voltage (max.)	300 V
Operating current	10 A (6, 12, 19 contacts); 8 A (remaining contacts)
Rated surge voltage	≥ 2.0 kV rms
Drag chain suitability	≥ 2 million bending cycles
Surrounding air temperature (operation), dynamic	-25 ... +80 °C
Protection type	IP67
Cable diameter	11.6 mm ±0.3

Interconnecting cable; 19-pole; M23 socket (straight)		
Cable Length	Item No.	Pack. Unit
5 m	756-3203/190-050	1
10 m	756-3203/190-100	1
15 m	756-3203/190-150	1

Interconnecting cable; 19-pole; M23 socket (angled)		
Cable Length	Item No.	Pack. Unit
5 m	756-3204/190-050	1
10 m	756-3204/190-100	1
15 m	756-3204/190-150	1



## Accessories and Tools






## Accessories and Tools Contents

		Page
	Power Supplies, 787 Series	Power Supplies Overview 448
		Backup Capacitor Module, DC/DC Converter 451
	System Wiring, 704, 706 Series	Interface Modules for System Wiring 452
		System Cables 454
	IP67 Cables and Connectors, 756 Series	Sensor/Actuator Cables and Distribution Connectors 456
		Configurable Connectors 464
		Torque Wrench M8 and M12 466
		ETHERNET Cables 467
	Configuration and Communication	<i>Bluetooth</i> <sup>®</sup> Adapter 468
		Communication Cables 469
		Memory Cards 470
	Antennas, 758 Series	GSM/UMTS/LTE/ <i>Bluetooth</i> <sup>®</sup> /WLAN 471
	Fieldbus Connectors, 750 Series	ETHERNET, PROFIBUS, PROFINET, CANopen, INTERBUS, CC-Link 472
	IP65 System Housings, 850 Series	Stainless Steel, Sheet Steel, Aluminum, Polyester 484
	DALI Multi-Master Accessories	DALI Multi-Sensor 490
		DALI Multi-Sensor Kit 492
		Power Supply to DALI Multi-Master 493
	Multi-Port Device Taps for DeviceNet, 810 Series	494
	Shield Connection System, 790, 791 Series	496
	Marking Accessories	504
	DIN-Rails and Accessories, 210, 249, 209 Series	506
	Tools, Test and Measurement Devices, 206, 210 Series	509

## Power Supplies

Additional Technical Data at [www.wago.com](http://www.wago.com)

	Item Number	Output	Input Voltage Range	Functional Description	
<b>Pro – Professional and Efficient Power Supplies with Extra Power</b>					
	787-819	12 VDC (11 ... 18 V) / 6 A	1 x 85 ... 264 VAC 120 ... 373 VDC	<ul style="list-style-type: none"> <li>• TopBoost provides up to 60 A of additional output for 50 ms</li> <li>• PowerBoost offers up to 200% output power for four seconds</li> <li>• DC OK contact and stand-by input</li> <li>• Clear operating status indication via LED</li> <li>• Up to 94% efficiency</li> <li>• Surrounding air temperature: -25 ... +70°C (device start at -40°C, type-tested)</li> <li>• Slim design and versatile mounting options</li> <li>• Pluggable CAGE CLAMP® connectors</li> <li>• Approvals: UL 508, UL 60950</li> <li>• LineMonitor for parameter setting and input/output monitoring<sup>a)</sup></li> </ul>	
	787-821	12 VDC (11 ... 18 V) / 10 A			
	787-831	12 VDC (11 ... 18 V) / 15 A			
	787-818	24 VDC (22 ... 29.5 V) / 3 A			
	787-822	24 VDC (22 ... 29.5 V) / 5 A			
	787-832	24 VDC (22 ... 29.5 V) / 10 A			
	787-834	24 VDC (22 ... 29.5 V) / 20 A			
	787-833	48 VDC (33 ... 52 V) / 5 A			
	787-835	48 VDC (33 ... 52 V) / 10 A			
	787-840	24 VDC (22.8 ... 28.8 V) / 10 A			2/3 x 340 ... 550 VAC 480 ... 780 VDC
	787-842	24 VDC (22.8 ... 28.8 V) / 20 A			
	787-844	24 VDC (22.8 ... 28.8 V) / 40 A			
	787-850 <sup>a)</sup>	24 VDC (22.8 ... 28.8 V) / 10 A			
	787-852 <sup>a)</sup>	24 VDC (22.8 ... 28.8 V) / 20 A			
	787-854 <sup>a)</sup>	24 VDC (22.8 ... 28.8 V) / 40 A			
	787-845	48 VDC (39 ... 53 V) / 10 A			
	787-847	48 VDC (39 ... 53 V) / 20 A			
<b>Classic – Robust Power Supplies with Integrated TopBoost</b>					
	787-1601 <sup>b)</sup>	12 VDC (11.5 ... 14.5 V) / 2 A	1/2 x 85 ... 264 VAC 120 ... 372 VDC	<ul style="list-style-type: none"> <li>• Slim design</li> <li>• Integrated TopBoost (787-16xx with ≥ 120 W)</li> <li>• DC OK signal/contact</li> <li>• Clear operating status indication via LED</li> <li>• Marking field for device identification</li> <li>• Up to 93% efficiency</li> <li>• Surrounding air temperature: -25 ... +70°C (device start at -40°C, type-tested)</li> <li>• Pluggable CAGE CLAMP® connectors</li> <li>• Approvals: UL 508, UL 60950, GL</li> <li>• Approval: EN 60335-1<sup>b)</sup></li> </ul>	
	787-1611 <sup>b)</sup>	12 VDC (11.5 ... 14.5 V) / 4 A			
	787-1621 <sup>b)</sup>	12 VDC (11.5 ... 14.5 V) / 7 A			
	787-1631	12 VDC (11.5 ... 15 V) / 15 A			
	787-1602 <sup>b)</sup>	24 VDC (23 ... 28.5 V) / 1 A			
	787-1606 <sup>b)</sup>	24 VDC (23 ... 28.5 V) / 2 A			
	787-1616 <sup>b)</sup>	24 VDC (23 ... 28.5 V) / 4 A			
	787-1616/000-1000 <sup>b)</sup>	24 VDC (23 ... 28.5 V) / 3.8 A LPS			
	787-1622 <sup>b)</sup>	24 VDC (23 ... 28.5 V) / 5 A			
	787-1632	24 VDC (23 ... 28.5 V) / 10 A			
	787-1634	24 VDC (23 ... 28.5 V) / 20 A			
	787-1623 <sup>b)</sup>	48 VDC (40 ... 56 V) / 2 A	1/2 x 180 ... 500 VAC 254 ... 780 VDC		
	787-1633	48 VDC (40 ... 56 V) / 5 A			
	787-1635	48 VDC (40 ... 56 V) / 10 A			
	787-1628	24 VDC (23 ... 28.5 V) / 5 A			
	787-1638	24 VDC (23 ... 28.5 V) / 10 A			2/3 x 320 ... 575 VAC 450 ... 800 VDC
	787-1640	24 VDC (23 ... 28.5 V) / 10 A			
	787-1642	24 VDC (23 ... 28.5 V) / 20 A			
	787-1644	24 VDC (23 ... 28.5 V) / 40 A			
	<b>Eco – Economical Power Supplies for Standard Applications</b>				
	787-712 <sup>c)</sup>	24 VDC (22 ... 28 V) / 2.5 A	1 x 85 ... 264 VAC 130 ... 373 VDC	<ul style="list-style-type: none"> <li>• Economical and robust metal housing</li> <li>• Clear operating status LED indication and optional DC OK contact</li> <li>• Up to 90% efficiency</li> <li>• Surrounding air temperature: -25 ... +70°C</li> <li>• Overhead mounting possible</li> <li>• Approvals: UL 508, UL 60950</li> <li>• Approvals: ATEX/IEC Ex, Zone 2 or Class I Div. 2<sup>c)</sup></li> </ul>	
	787-722 <sup>c)</sup>	24 VDC (22 ... 28 V) / 5 A			
	787-732 <sup>c)</sup>	24 VDC (22 ... 28 V) / 10 A			
	787-734	24 VDC (22 ... 28 V) / 20 A	1 x 90 ... 264 VAC 130 ... 373 VDC		
	787-736	24 VDC (22 ... 28 V) / 40 A			
	787-738	24 VDC (22 ... 28 V) / 6.25 A	2/3 x 360 ... 460 VAC		
	787-740	24 VDC (24 ... 28 V) / 10 A			
	787-2742	24 VDC (22 ... 28 V) / 20 A	2/3 x 340 ... 575 VAC 460 ... 800 VDC		
	787-2744	24 VDC (24 ... 28 V) / 40 A			
	787-1701	12 VDC (10 ... 14 V) / 2 A	1 x 90 ... 264 VAC 125 ... 375 VDC		<ul style="list-style-type: none"> <li>• Budget-friendly for basic applications</li> <li>• Flexible mounting via DIN-rail adapter</li> <li>• Flexible installation via screw-mount clips</li> <li>• Up to 84% efficiency</li> <li>• Approvals: UL 508, UL 60950, EN 60335-1</li> </ul>
	787-1711	12 VDC (10 ... 14 V) / 4 A			
	787-1721	12 VDC (10 ... 14 V) / 8 A			
	787-1702	24 VDC (22 ... 26 V) / 1.25 A			
	787-1712	24 VDC (22 ... 26 V) / 2.5 A			
787-1722	24 VDC (22 ... 26 V) / 5 A				
787-1732	24 VDC (22 ... 26 V) / 10 A				




## Power Supplies

Additional Technical Data at [www.wago.com](http://www.wago.com)

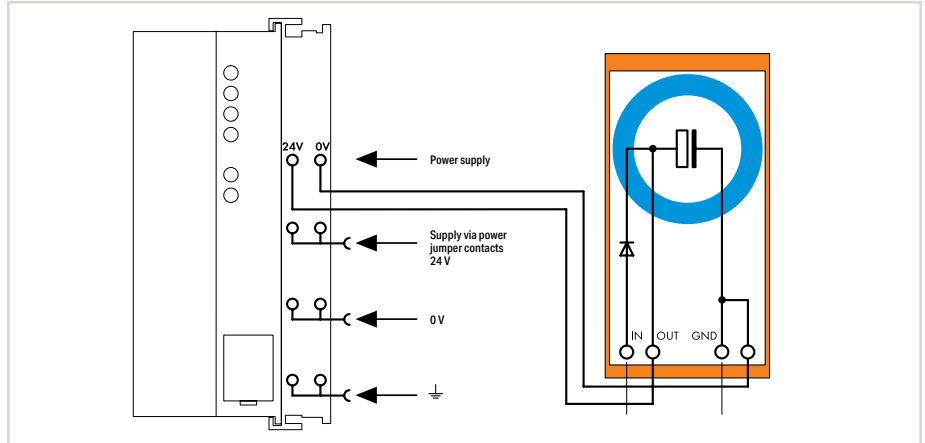
	Item Number	Output	Input Voltage Range	Functional Description
<b>COMPACT Power – Compact and High-Performance Power Supplies</b>				
	787-1001	12 VDC (10.8 ... 18 V) / 2 A	1 x 85 ... 264 VAC 120 ... 373 VDC	<ul style="list-style-type: none"> <li>• Compact, low-profile design</li> <li>• Ideal for decentralized applications</li> <li>• Clear operating status indication via LED</li> <li>• Up to 88% efficiency</li> <li>• Surrounding air temperature: -25 ... +60°C (device start at -40°C, type-tested)</li> <li>• Overhead mounting permitted</li> <li>• Approvals: UL 508, UL 60950, GL</li> </ul>
	787-1011	12 VDC (10.5 ... 15.5 V) / 4 A		
	787-1021	12 VDC (10.5 ... 15.5 V) / 6.5 A		
	787-1017	18 VDC (15 ... 28 V) / 2.5 A		
	787-1002	24 VDC (22.8 ... 26.4 V) / 1.3 A		
	787-1012	24 VDC (22.8 ... 26.4 V) / 2.5 A		
	787-1022	24 VDC (22.8 ... 26.4 V) / 4 A		
	787-1020	5 VDC (4.5 ... 8.5 V) / 5.5 A		
	787-1102	24 VDC (22.8 ... 26.4 V) / 1.3 A	1 x 90 ... 264 VAC 125 ... 375 VDC	<ul style="list-style-type: none"> <li>• Budget-friendly for basic applications</li> <li>• Mounting on DIN-rail and flexible installation via screw-mount clips</li> <li>• Removable front plate improves cooling in alternative mounting positions</li> <li>• Up to 90% efficiency</li> <li>• Surrounding air temperature: -25 ... +70°C</li> <li>• Approvals: UL 508, UL 60950, EN 60335-1</li> </ul>
	787-1112	24 VDC (22.8 ... 26.4 V) / 2.5 A		
	787-1122	24 VDC (22.8 ... 26.4 V) / 4 A		
	787-1202	24 VDC (22 ... 26 V) / 1.3 A		
	787-1212	24 VDC (22 ... 26 V) / 2.5 A		
	787-1216	24 VDC (22 ... 26 V) / 4.2 A		
	787-1226	24 VDC (22 ... 26 V) / 6 A		
<b>IP67 Power – Reliable Power Supply for Distributed Automation</b>				
	787-6716	24 VDC / 4 A	1x 90 ... 264 VAC	<ul style="list-style-type: none"> <li>• IP67 protection</li> <li>• PowerBoost offers up 150% output power for four seconds</li> <li>• Efficiency: 92.3%</li> <li>• Surrounding air temperature: -40 ... +85°C</li> </ul>
<b>Safety Transformers – Robust and Low-Profile DIN-Rail-Mount Modules</b>				
	787-974	12/24 VAC (0 ... 24 V) / 40 VA	110/230 VAC (0 ... 230 V)	<ul style="list-style-type: none"> <li>• Robust housing for easy and vibration-proof DIN-rail mounting</li> <li>• Surrounding air temperature: -25 ... +55°C</li> <li>• Approval: UL 5085</li> </ul>
	787-976	12/24 VAC (0 ... 24 V) / 63 VA		
<b>Fan Control</b>				
	787-914	22 VDC (12 ... 22 V) / 1 A	1 x 90 ... 264 VAC 130 ... 373 VDC	<ul style="list-style-type: none"> <li>• Adjustable output voltage: 12 ... 22 VDC, front side by tool and analog signal 0 ... 10 V</li> <li>• Easy mounting on DIN-rail</li> <li>• Flexible installation via screw-mount clips</li> </ul>
<b>DC/DC Converters – Dependable Power Supply for Specialty Voltages</b>				
	787-2801	5 VDC / 0.5 A	24 VDC (10 ... 30 V)	<ul style="list-style-type: none"> <li>• Full commoning of the supply voltage with both 857 and 2857 Series</li> <li>• DC OK contact</li> <li>• Approvals: UL 508, UL 60950</li> </ul>
	787-2802	10 VDC / 0.5 A	24 VDC (15 ... 30 V)	
	787-2803	24 VDC / 0.5 A	48 VDC (40 ... 55 V)	
	787-2805	12 VDC / 0.5 A	24 VDC (15 ... 30 V)	
	787-2810	5 / 10 / 12 VDC, adjustable / 0.5 A	24 VDC (10 ... 30 V)	
	787-1014	24 VDC / 2 A	110 VDC (77 ... 140 V)	<ul style="list-style-type: none"> <li>• Electrically isolated output</li> <li>• Suitable for railway applications per EN 50155</li> <li>• Approvals: UL 508, UL 60950 (except 787-1015/0072-0000)</li> </ul>
	787-1014/072-000	24 VDC / 2 A	72 VDC (40 ... 90 V)	
	787-1015/072-000	12 VDC / 4 A	72 VDC (40 ... 90 V)	
	787-1650	12 VDC / 4 A	24 VDC (18 ... 60 V)	
<b>Uninterruptible Power Supplies (UPS) – Reliably Compensate for Long Power Outages</b>				
	787-870	24 VDC (20 ... 25.5 V) / 10 A	24 VDC	<ul style="list-style-type: none"> <li>• Slim UPS charger and controller with convenient visualization and configuration</li> <li>• Optional power supply with integrated UPS charger and controller (787-1675)</li> <li>• Battery control technology for predictive maintenance that extends battery life</li> <li>• Pluggable CAGE CLAMP® connectors</li> <li>• Approvals: UL 508, UL 60950</li> </ul>
	787-875	24 VDC (20 ... 25.5 V) / 20 A		
	787-1675	23 ... 28.5 VDC (mains operation) 18.5 ... 27.5 VDC (battery operation) / 5 A	1/2 x 85 ... 264 VAC 110 ... 370 VDC	
	787-1671	24 VDC / max. 5 A / 0.8 Ah	24 VDC	
	787-876	24 VDC / max. 7.5 A / 1.2 Ah		
	787-871	24 VDC / max. 20 A / 3.2 Ah		
	787-872	24 VDC / max. 40 A / 7 Ah		
	787-873	24 VDC / max. 40 A / 12 Ah		

## Power Supplies

Additional Technical Data at [www.wago.com](http://www.wago.com)

	Item Number	Output	Input Voltage Range	Functional Description	
<b>Capacitive Buffer Modules – Short-Term Power Reserves for Power Outages and Load Variations</b>					
	787-880	24 VDC (20.4 ... 24 V) / 10 A	24 VDC	<ul style="list-style-type: none"> <li>Maintenance-free, high-energy gold caps</li> <li>Integrated diodes for decoupling buffered loads from unbuffered loads</li> <li>Parallel connections possible</li> <li>Indication via LED and contact</li> <li>Configurable switch-on threshold</li> <li>Surrounding air temperature: -10 ... +50°C</li> <li>Pluggable CAGE CLAMP® connectors</li> <li>Approval: UL 508</li> </ul>	
	787-881	24 VDC (20.4 ... 24 V) / 20 A			
<b>Redundancy Modules – Reliably Increase Power Supply Stability</b>					
	787-1685	24 VDC / 20 A, max. 40 A	2 x 24 VDC	<ul style="list-style-type: none"> <li>Integrated power diodes or MOSFET (787-1685 only) with overload capability</li> <li>Solutions for 12/24/48 VDC supply, up to 76 A</li> <li>Parallel connections possible, reverse voltage protection</li> <li>Clear operating status LED indication and optional signal contact</li> <li>Surrounding air temperature: -25 ... +70°C (787-1685: cold start at -40°C)</li> <li>Approvals: UL 508, UL 60950</li> </ul>	
	787-885	24 VDC / 20 A, max. 40 A			
	787-886	48 VDC / 20 A, max. 40 A	2 x 48 VDC		
	787-783	9 ... 54 VDC / 12.5 A, max. 25 A	2 x 9 ... 54 VDC		
	787-785	9 ... 54 VDC / 40 A, max. 76 A			
<b>Electronic Circuit Breakers – Compact and Precise ECBs for DC Circuits</b>					
	787-2861/100-000	1 x 24 VDC / 1 A	24 VDC	<ul style="list-style-type: none"> <li>One channel with preset nominal current</li> <li>Two, four or eight channels with a six-stage adjustable nominal current</li> <li>Slim design, communication capability</li> <li>High switch-on capacity reduces false tripping</li> <li>Surrounding air temperature: -25 ... +70°C</li> <li>Approvals: UL 508, UL 2367, UL 61010, GL</li> <li>Optional active current limitation <sup>d)</sup></li> <li>With potential-free signal contact <sup>e)</sup></li> <li>Specialty configuration <sup>f)</sup></li> <li>Communication via IO-Link protocol <sup>g)</sup></li> </ul>	
	787-2861/200-000	1 x 24 VDC / 2 A			
	787-2861/400-000	1 x 24 VDC / 4 A			
	787-2861/600-000	1 x 24 VDC / 6 A			
	787-2861/800-000	1 x 24 VDC / 8 A			
	787-2861/108-020	1 x 24 VDC / 1 ... 8 A			
	787-1662	2 x 24 VDC / 2 ... 10 A			
	787-1662/106-000	2 x 24 VDC / 1 ... 6 A			
	787-1662/000-054 <sup>e, f)</sup>	2 x 24 VDC / 2 ... 10 A			
	787-1662/004-1000 <sup>d)</sup>	2 x 24 VDC / 3.8 A			
	787-1662/006-1000 <sup>d)</sup>	2 x 24 VDC / 0.5 ... 6 A			
	787-1664	4 x 24 VDC / 2 ... 10 A			
	787-1664/106-000	4 x 24 VDC / 1 ... 6 A			
	787-1664/000-004 <sup>f)</sup>	4 x 24 VDC / 2 ... 10 A			
	787-1664/000-054 <sup>e, f)</sup>	4 x 24 VDC / 2 ... 10 A			
	787-1664/000-080 <sup>g)</sup>	4 x 24 VDC / 2 ... 10 A			
	787-1664/004-1000 <sup>d)</sup>	4 x 24 VDC / 3.8 A			
	787-1664/006-1000 <sup>d)</sup>	4 x 24 VDC / 0.5 ... 6 A			
	787-1664/212-1000 <sup>d)</sup>	4 x 24 VDC / 2 ... 12 A			
	787-1664/006-1054 <sup>d, e, f)</sup>	4 x 24 VDC / 0.5 ... 6 A			
	787-1668	8 x 24 VDC / 2 ... 10 A			
	787-1668/106-000	8 x 24 VDC / 1 ... 6 A			
	787-1668/000-004 <sup>f)</sup>	8 x 24 VDC / 2 ... 10 A			
	787-1668/000-054 <sup>e, f)</sup>	8 x 24 VDC / 2 ... 10 A			
	787-1668/000-080 <sup>g)</sup>	8 x 24 VDC / 2 ... 10 A			
	787-1668/006-1000 <sup>d)</sup>	8 x 24 VDC / 0.5 ... 6 A			
	787-1668/006-1054 <sup>d, e, f)</sup>	8 x 24 VDC / 0.5 ... 6 A			
	787-1664/000-100	4 x 12 VDC / 2 ... 10 A			12 VDC
	787-1662/000-250 <sup>e)</sup>	2 x 48 VDC / 2 ... 10 A			48 VDC
	787-1664/000-200	4 x 48 VDC / 2 ... 10 A			
	787-1664/000-250 <sup>e)</sup>	4 x 48 VDC / 2 ... 10 A			
	787-1668/000-200	8 x 48 VDC / 2 ... 10 A			
787-1668/000-250 <sup>e)</sup>	8 x 48 VDC / 2 ... 10 A				

## Backup Capacitor Module and DC/DC Converter



### Item Description

Item No.

**Component module with capacitor; 1 module;**  
**Capacity: 10 mF; Nominal voltage: 24 VDC**  
**288-824**

This back-up capacitor module smooths unstable 24 VDC power supplies for electronic modules in case the voltage tolerances mentioned in our data sheets cannot be ensured. Reasons for voltage transients could be:

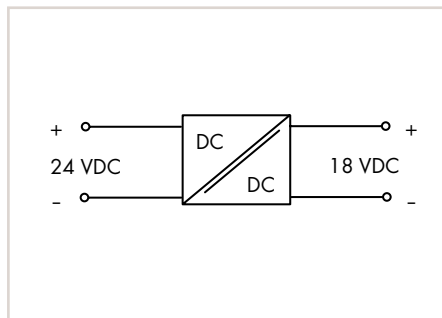
- Power interruptions (switching transients) on primary side
- Overloads on secondary side
- Switching of inductive or capacitive loads
- The back-up capacitor module is connected between the 24 V power supply and the electronic device to be protected.

**Notice:**

Using insufficiently smoothed and unregulated single-phase power supplies may lead to voltage increases by the back-up capacitor module.

### Technical Data

Nominal input voltage (DC) max.	24 VDC (+25 %)
Input current I <sub>i</sub> (max.)	1 A
Nominal capacity	10 mF
Weight	104.4 g
Dimensions W x H x D	38 x 81 x 85 mm; height from upper-edge of DIN-rail
Conductor connection	CAGE CLAMP® (236 Series)
Conductor cross sections	0.08 ... 2.5 mm <sup>2</sup> / 28 ... 12 AWG
Strip length	5 ... 6 mm / 0.24 inch
<b>Data sheet and further information, see:</b>	<a href="http://wago.com/288-824">wago.com/288-824</a>



### Item Description

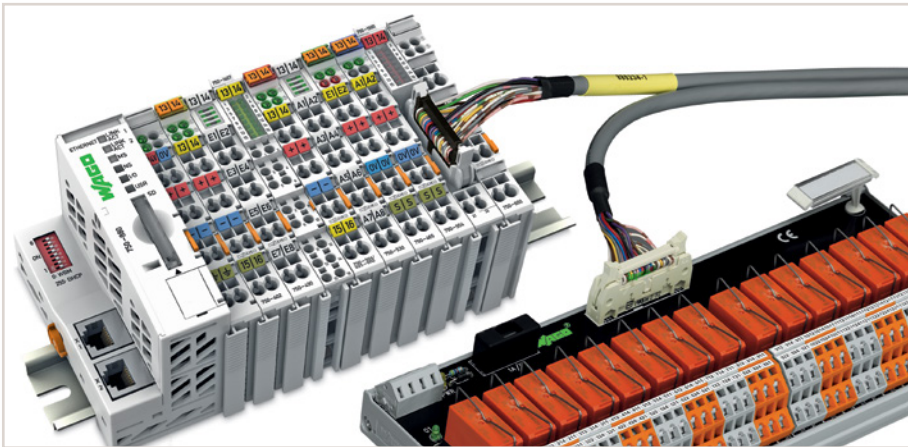
Item No.

**DC/DC Converter; Input voltage: 24 VDC;**  
**Output voltage: 18 VDC;**  
**Output current: 0.4 A**  
**288-895**

### Technical Data

Nominal input voltage (DC) max.	24 VDC
Input Voltage Range	18 ... 36 VDC
Nominal output voltage (DC)	18 VDC (±2 %)
Output nominal current	0.4 A
Efficiency	82 %
Short-circuit-protected	Yes
Surrounding air temperature (operation)	-25 ... +70 °C
Weight	76 g
Dimensions W x H x D	50 x 25 x 85 mm; height from upper-edge of DIN-rail
Conductor connection	CAGE CLAMP® (256 Series)
Conductor cross sections	0.08 ... 2.5 mm <sup>2</sup> / 28 ... 12 AWG (THHN, THWN)
Strip length	5 ... 6 mm / 0.24 inch
<b>Data sheet and further information, see:</b>	<a href="http://wago.com/288-895">wago.com/288-895</a>

# Interface Modules for System Wiring



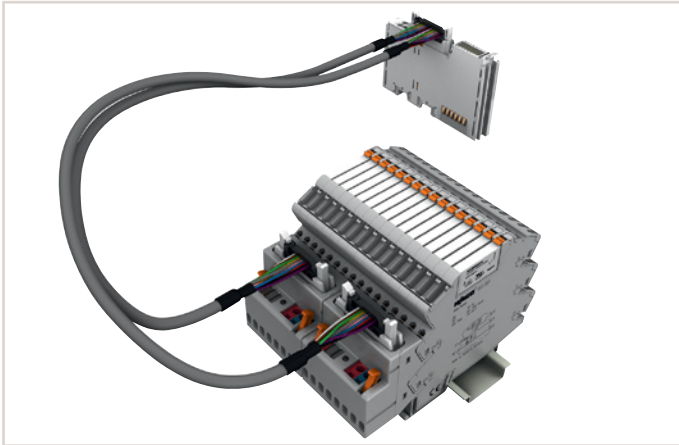
I/O modules equipped with a ribbon cable connector provide easy and fast connection of WAGO interface modules to the WAGO-I/O-SYSTEM. WAGO's pre-assembled system cables eliminate discrete wiring, while reducing costs for system wiring applications. Furthermore, modules can be pre-wired, also allowing the connection level to be relocated.

WAGO-I/O-SYSTEM 750			WAGO System Cables		WAGO Interface Modules	
I/O Module	Item No.		System Cable	Item No.	Interface Module	Item No.
DI	750-1400	16-Channel Digital Input; 24 VDC; 3 ms; Ribbon cable		706-3057/300-xxx (see page 452)		Input Module; 20-pole; T16ES: 289-614, 704-2004, 704-2024, 704-2044, 704-2054*
	750-1402	16-Channel Digital Input; 24 VDC; 3 ms; Low-side switching; Ribbon cable		706-7753/302-xxx (see page 452)		Input Module; 10-pole; T8ES: 289-611, 704-2003*
DO	750-1500	16-Channel Digital Output; 24 VDC; 0.5 A; Ribbon cable		706-3057/300-xxx (see page 452)		Output Module; 20-pole; T16S: 704-5004, 704-5014, 704-5024, 704-5034, 704-5044, 704-5054, 704-5064, 704-5074* or Input Module; 20-pole; Relay Module; 16 channels
	750-1501	16-Channel Digital Output; 24 VDC; 0.5 A; Low-side switching; Ribbon cable		706-7753/302-xxx (see page 452)		Relay Module; 8 channels T8S: 704-5003, 704-5013* or Input Module; 10-pole
DI/DO	750-1502	8-Channel Digital Input/Output; 24 VDC; 0.5 A; Ribbon cable		706-7753/302-xxx (see page 452)		Input Module; 10-pole; T8ES: 289-611, 704-2003*
						Relay Module; 8 channels T8S: 704-5003, 704-5013* or Input Module; 10-pole
WAGO-I/O-SYSTEM 753			WAGO System Cables		WAGO Interface Modules	
I/O Module	Item No.		System Cable	Item No.	Interface Module	Item No.
DI	753-430 753-431 753-436 753-437	8 DI 8 DI 8 DI 8 DI		706-7753/300-xxx (see page 453)		Input Module; 10-pole; T8ES: 289-611, 704-2003*
	753-430 (x2) 753-431 (x2) 753-436 (x2) 753-437 (x2)	2 x 8 DI 2 x 8 DI 2 x 8 DI 2 x 8 DI		706-7753/301-xxx (see page 453)		Input Module; 20-pole; T16ES: 289-614, 704-2004, 704-2024, 704-2044, 704-2054*
DO	753-530	8 DO		706-7753/300-xxx (see page 453)		Relay Module; 8 channels T8S: 704-5003, 704-5013* or Input Module; 10-pole
	753-530 (x2)	2 x 8 DO		706-7753/301-xxx (see page 453)		Relay Module; 16 channels T16S: 704-5004, 704-5014, 704-5024, 704-5034, 704-5044, 704-5054, 704-5064, 704-5074* or Input Module; 20-pole

\*For additional technical data, visit [www.wago.com](http://www.wago.com).

10

# Interface Adapter for System Wiring



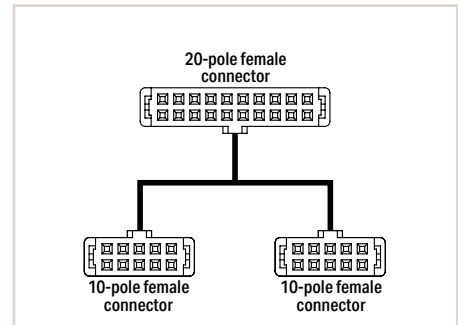
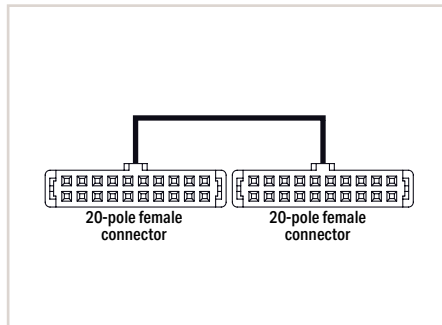
## WAGO Interface Adapter, 857 Series

WAGO's Interface Adapter quickly connects the WAGO-I/O-SYSTEM (PLC) to 857 Series Relay/Optocoupler Modules via pre-assembled WAGO System Cables (706 Series). This eliminates cumbersome discrete wiring between 750 Series I/O Modules and 857 Series Relays/Optocouplers. As a result, both installation time and costs are reduced. Depending on the application, WAGO's Interface Adapters can be used with D-sub or ribbon cable connectors. They feature both status indicator and integrated test ports for each channel. The interface adapters are simply plugged into the 857 Series Relay/Optocoupler Modules via jumper slot. Furthermore, the WAGO Interface Adapter features locking devices for secure connection.

WAGO-I/O-SYSTEM 750			WAGO System Cables		WAGO Interface Adapters	
I/O Module	Item No.		System Cable	Item No.	Interface Adapter	Item No.
DI	750-1400	16-Channel Digital Input; 24 VDC; 3 ms; Ribbon cable		706-7753/304-xxx*		Item No.: 857-982*; Interface Adapter; 14-pole; High-side switching output
	750-1402	16-Channel Digital Input; 24 VDC; 3 ms; Low-side switching; Ribbon cable				
DO	750-1500	16-Channel Digital Output; 24 VDC; 0.5 A; Ribbon cable		706-7753/306-xxx*		Item No.: 857-986*; Interface Adapter; 15-pole; High-side switching input
	750-1501	16-Channel Digital Output; 24 VDC; 0.5 A; Low-side switching; Ribbon cable				
DI/DO	750-1502	8DI 8DO 24 VDC 0.5 A; Ribbon cable		706-7753/304-xxx*		Item No.: 857-982*; Interface Adapter; 14-pole; High-side switching output
				706-7753/306-xxx*		Item No.: 857-986*; Interface Adapter; 15-pole; High-side switching input

\*For additional technical data, visit [www.wago.com](http://www.wago.com).

# System Cable for 289, 704 Series, in Connection with the WAGO-I/O-SYSTEM 750 706 Series



System Cable; for Schneider TSX; 16 digital inputs or outputs		
Length	Item No.	Pack. Unit
1 m	706-3057/300-100	1
2 m	706-3057/300-200	1
2 m (UL listed)	706-3057/1300-300	1
3 m	706-3057/300-300	1

WAGO's System Cables provide fast and easy connection of WAGO I/O Modules equipped with HE 10 pluggable connector (750-1400, -1402, -1500, -1501, -1502) to appropriate interface or relay modules (16-channel) featuring a 20-pole HE 10 pluggable connector.

System Cable; for WAGO-I/O-SYSTEM, 753 Series; 8 digital inputs and 8 digital outputs		
Length	Item No.	Pack. Unit
1 m	706-7753/302-100	1
2 m	706-7753/302-200	1

WAGO's System Cables provide fast and easy connection of WAGO I/O Modules equipped with HE 10 pluggable connector (750-1400, -1402, -1500, -1501, -1502) to appropriate interface or relay modules (16-channel) featuring a 10-pole HE 10 pluggable connector. For example, this cable connects two relay modules (8-channel) to a WAGO I/O Module.

### Technical Data

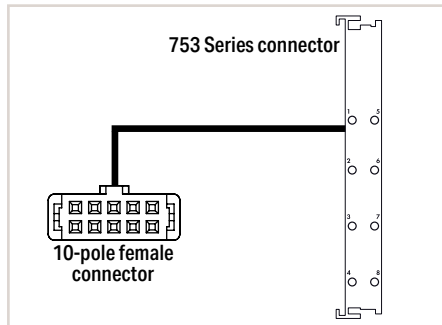
Connectors	2 x 20-pole connector per DIN 41651
Wire cross section	0.14 mm <sup>2</sup> LiYY
Color code	per DIN VDE 47100
Current per wire (max.)	1 A
Surrounding air temperature (operation)	-25 ... +70 °C
Protection type	IP20

Connectors	1 x 20-pole / 2 x 10-pole connector per DIN 41651
Wire cross section	0.14 mm <sup>2</sup> LiYY
Color code	per DIN VDE 47100
Current per wire (max.)	1 A
Surrounding air temperature (operation)	-25 ... +70 °C
Protection type	IP20

Connectors	1 x 20-pole / 2 x 10-pole connector per DIN 41651
Wire cross section	0.14 mm <sup>2</sup> LiYY
Color code	per DIN VDE 47100
Current per wire (max.)	1 A
Surrounding air temperature (operation)	-25 ... +70 °C
Protection type	IP20

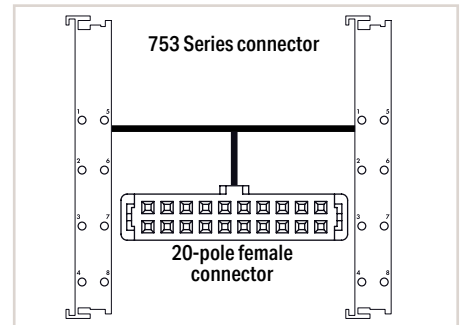


# System Cable for 289, 704 Series, in Connection with the WAGO-I/O-SYSTEM 753 706 Series



**System Cable; for WAGO-I/O-SYSTEM, 753 Series; 8 digital inputs or outputs**

Length	Item No.	Pack. Unit
1 m	706-7753/300-100	1
2 m	706-7753/300-200	1



**System Cable; for WAGO-I/O-SYSTEM, 753 Series; 16 digital inputs or outputs**

Length	Item No.	Pack. Unit
2 m	706-7753/301-200	1

WAGO's System Cables provide fast and easy connection of WAGO I/O Modules equipped with a pluggable connector (e.g., 753-430, -431, -530) to appropriate interface or relay modules featuring 10-pole connectors.

WAGO's System Cables provide fast and easy connection of WAGO I/O Modules equipped with a pluggable connector (e.g., 753-430, -431, -530) to appropriate interface or relay modules featuring 20-pole connectors. For example, this cable connects two WAGO I/O Modules to one relay output module (16-channel).

### Technical Data

Connectors	Plug (753 Series) / 10-pole connector per DIN 41651
Wire cross section	0.14 mm <sup>2</sup> LiYY
Color code	per DIN VDE 47100
Current per wire (max.)	1 A
Surrounding air temperature (operation)	-25 ... +70 °C*
Protection type	IP20

Connectors	Plug (753 Series) / 20-pole connector per DIN 41651
Wire cross section	0.14 mm <sup>2</sup> LiYY
Color code	per DIN VDE 47100
Current per wire (max.)	1 A
Surrounding air temperature (operation)	-25 ... +70 °C*
Protection type	IP20

\* Observe the surrounding air temperature (operation) of the WAGO I/O Modules used.

## IP67 Cables and Pluggable Connectors



The 756 Series offers a wide range of accessories for connecting inductive or capacitive proximity switches, photoelectric sensors, flow monitors, limit switches, pressure switches, etc. The cables not only protect against the ingress of dust and water, but also provide protection against self-loosening due to vibration in the form of a constructive "brake" due to the design of their coupling nuts. Injected cable entries also offer a kink protection function.

A distinction is made between cables assembled on one or both ends. Cables assembled on one end are often used where an exact cable length can not be determined or the installation of cables with connectors proves to be very difficult. These free-end cables therefore offer an individual possibility to adapt to the respective requirements as needed. In contrast, cables assembled on both sides reduce installation and installation times and therefore offer cost advantages in particular.

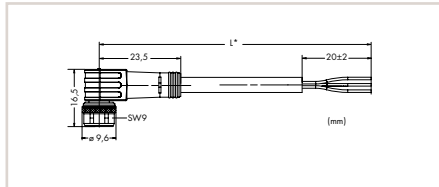
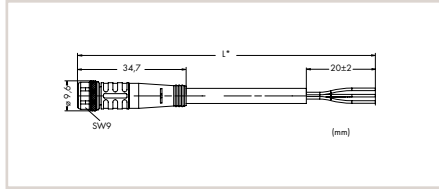
## Sensor/Actuator Cable; Fitted on One End

### M8 Socket



3-pole

Pin 1 ... 4: 0.34 mm<sup>2</sup>  
 1 brown (+)  
 3 blue (-)  
 4 black (S)



Operating voltage	60 VAC/DC
Operating current	4 A (max.)
Rated surge voltage	1.5 kV
Drag chain suitability	≥ 2 million bending cycles
Surrounding air temperature (operation), dynamic	-25 ... +90 °C
Protection type	IP67
Cable diameter	4.1 mm ±0.2

### Sensor/Actuator Cable; M8 socket (straight)

Pole No.	Cable Length	Item No.	Pack. Unit
3-pole	1.5 m	756-5101/030-015	10
3-pole	5 m	756-5101/030-050	10
3-pole	10 m	756-5101/030-100	10

### Sensor/Actuator Cable; M8 socket (angled)

Pole No.	Cable Length	Item No.	Pack. Unit
3-pole	1.5 m	756-5102/030-015	10
3-pole	5 m	756-5102/030-050	10
3-pole	10 m	756-5102/030-100	10

### M12 Socket



3-pole

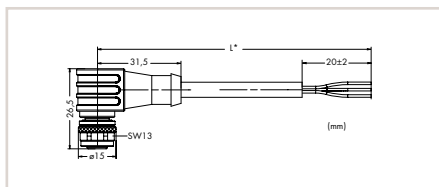
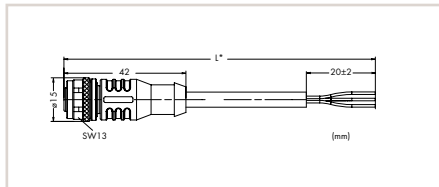


4-pole



5-pole

Pin 1 ... 5: 0.34 mm<sup>2</sup>  
 1 brown (+)  
 2 white (Ö)  
 3 blue (-)  
 4 black (S)  
 5 gray



Operating voltage	250 VAC/DC
Operating current	4 A (max.)
Rated surge voltage	2.5 kV (3-, 4-pole); 1.5 kV (5-pole)
Drag chain suitability	≥ 2 million bending cycles
Surrounding air temperature (operation), dynamic	-25 ... +90 °C
Protection type	IP67
Cable diameter	4.3 mm ±0.2 (3-pole); 4.7 mm ±0.2 (4-pole); 5.0 mm ±0.2 (5-pole); 6.5 mm ±0.2 (5-pole; shielded)

### Sensor/Actuator Cable; M12 socket (straight)


Pole No.	Cable Length	Item No.	Pack. Unit
3-pole	1.5 m	756-5301/030-015	10
3-pole	5 m	756-5301/030-050	10
3-pole	10 m	756-5301/030-100	10
4-pole	1.5 m	756-5301/040-015	10
4-pole	5 m	756-5301/040-050	10
4-pole	10 m	756-5301/040-100	10
5-pole	1.5 m	756-5301/050-015	10
5-pole	5 m	756-5301/050-050	10
5-pole	10 m	756-5301/050-100	10
5-pole; shielded	1.5 m	756-5301/060-015	10
5-pole; shielded	5 m	756-5301/060-050	10
5-pole; shielded	10 m	756-5301/060-100	10

### Sensor/Actuator Cable; M12 socket (angled)

Pole No.	Cable Length	Item No.	Pack. Unit
3-pole	1.5 m	756-5302/030-015	10
3-pole	5 m	756-5302/030-050	10
3-pole	10 m	756-5302/030-100	10
4-pole	1.5 m	756-5302/040-015	10
4-pole	5 m	756-5302/040-050	10
4-pole	10 m	756-5302/040-100	10
5-pole	1.5 m	756-5302/050-015	10
5-pole	5 m	756-5302/050-050	10
5-pole	10 m	756-5302/050-100	10
5-pole; shielded	1.5 m	756-5302/060-015	10
5-pole; shielded	5 m	756-5302/060-050	10
5-pole; shielded	10 m	756-5302/060-100	10

## Sensor/Actuator Cable; Fitted on One End

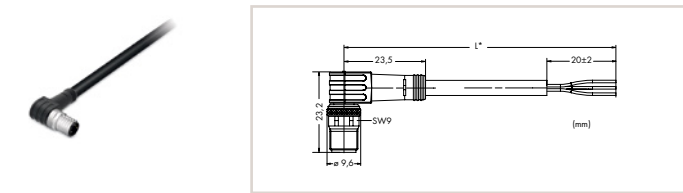
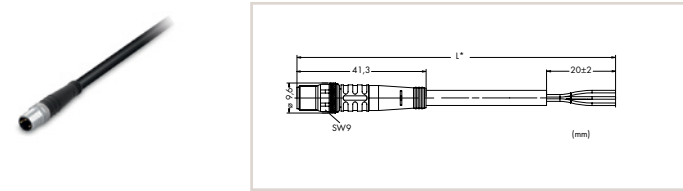
**M8 Plug**



Pin 1 ... 4: 0.34 mm<sup>2</sup>

- 1 brown (+)
- 3 blue (-)
- 4 black (S)

3-pole



Operating voltage	60 VAC/DC
Operating current	4 A (max.)
Rated surge voltage	1.5 kV
Drag chain suitability	≥ 2 million bending cycles
Surrounding air temperature (operation), dynamic	-25 ... +90 °C
Protection type	IP67
Cable diameter	4.1 mm ±0.2


### Sensor/Actuator Cable; M8 plug (straight)

Pole No.	Cable Length	Item No.	Pack. Unit
3-pole	1.5 m	756-5111/030-015	10
3-pole	5 m	756-5111/030-050	10
3-pole	10 m	756-5111/030-100	10


### Sensor/Actuator Cable; M8 plug (angled)

Pole No.	Cable Length	Item No.	Pack. Unit
3-pole	1.5 m	756-5112/030-015	10
3-pole	5 m	756-5112/030-050	10
3-pole	10 m	756-5112/030-100	10

**M12 Plug**



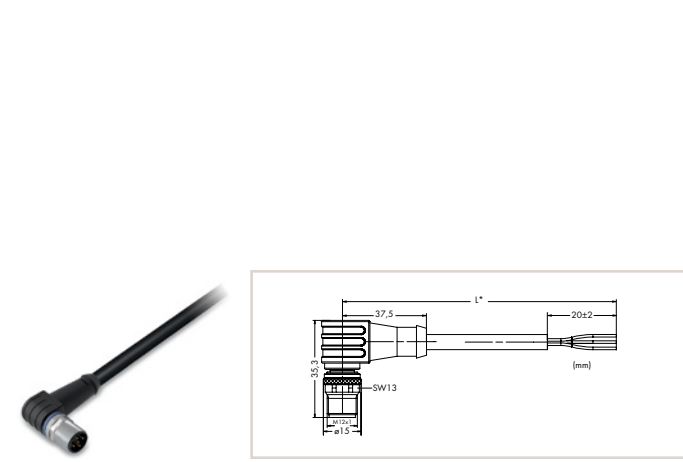
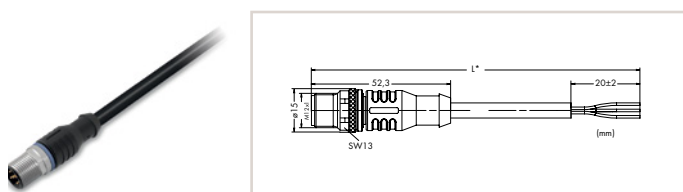
3-pole (Pin 2: n.c.)  
4-pole



5-pole

Pin 1 ... 5: 0.34 mm<sup>2</sup>

- 1 brown (+)
- 2 white (Ö)
- 3 blue (-)
- 4 black (S)
- 5 gray



Operating voltage	250 VAC/DC
Operating current	4 A (max.)
Rated surge voltage	2.5 kV (3-, 4-pole); 1.5 kV (5-pole)
Drag chain suitability	≥ 2 million bending cycles
Surrounding air temperature (operation), dynamic	-25 ... +90 °C
Protection type	IP67
Cable diameter	4.3 mm ±0.2 (3-pole); 4.7 mm ±0.2 (4-pole); 5.0 mm ±0.2 (5-pole); 6.5 mm ±0.2 (5-pole; shielded)

### Sensor/Actuator Cable; M12 plug (straight)

Pole No.	Cable Length	Item No.	Pack. Unit
3-pole	1.5 m	756-5311/030-015	10
3-pole	5 m	756-5311/030-050	10
3-pole	10 m	756-5311/030-100	10
4-pole	1.5 m	756-5311/040-015	10
4-pole	5 m	756-5311/040-050	10
4-pole	10 m	756-5311/040-100	10
5-pole	1.5 m	756-5311/050-015	10
5-pole	5 m	756-5311/050-050	10
5-pole	10 m	756-5311/050-100	10
5-pole; shielded	1.5 m	756-5311/060-015	10
5-pole; shielded	5 m	756-5311/060-050	10
5-pole; shielded	10 m	756-5311/060-100	10

### Sensor/Actuator Cable; M12 plug (angled)

Pole No.	Cable Length	Item No.	Pack. Unit
3-pole	1.5 m	756-5312/030-015	10
3-pole	5 m	756-5312/030-050	10
3-pole	10 m	756-5312/030-100	10
4-pole	1.5 m	756-5312/040-015	10
4-pole	5 m	756-5312/040-050	10
4-pole	10 m	756-5312/040-100	10
5-pole	1.5 m	756-5312/050-015	10
5-pole	5 m	756-5312/050-050	10
5-pole	10 m	756-5312/050-100	10
5-pole; shielded	1.5 m	756-5312/060-015	10
5-pole; shielded	5 m	756-5312/060-050	10
5-pole; shielded	10 m	756-5312/060-100	10

10

## Sensor/Actuator Cable; Fitted on One End

### M12 Plug

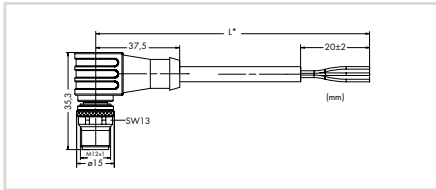
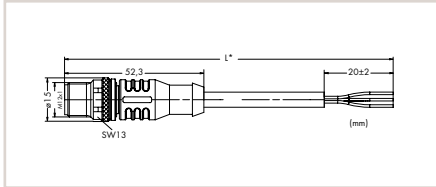


8-pole, shielded

Pin 1 ... 8: 0.25 mm<sup>2</sup>

- 1 white
- 2 brown
- 3 green
- 4 yellow
- 5 gray
- 6 rose
- 7 blue
- 8 red
- Shield

Operating voltage	250 VAC/DC
Operating current	4 A (max.)
Rated surge voltage	1.5 kV
Drag chain suitability	≥ 2 million bending cycles
Surrounding air temperature (operation), dynamic	-25 ... +90 °C
Protection type	IP67
Cable diameter	6.3 mm ±0.2



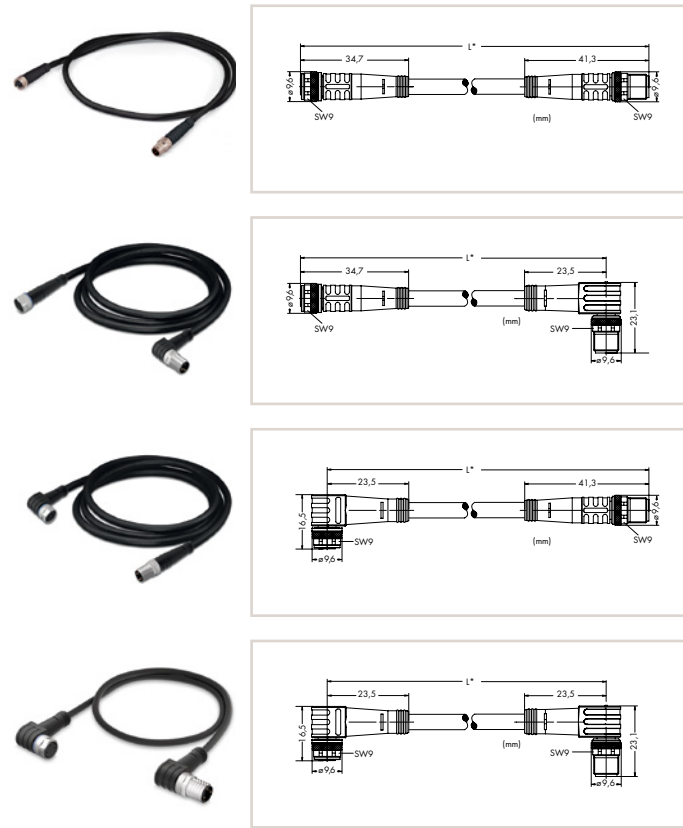
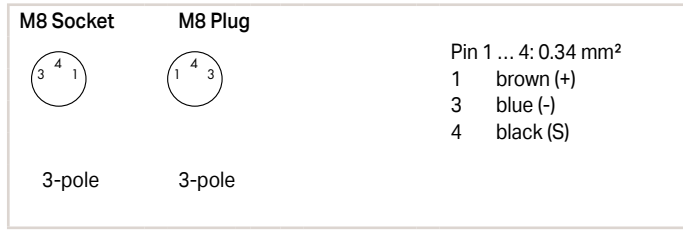
### Sensor/Actuator Cable; M12 plug (straight)

Pole No.	Cable Length	Item No.	Pack. Unit
8-pole; shielded	1.5 m	756-5311/090-015	10
8-pole; shielded	5 m	756-5311/090-050	10
8-pole; shielded	10 m	756-5311/090-100	10

### Sensor/Actuator Cable; M12 plug (angled)

Pole No.	Cable Length	Item No.	Pack. Unit
8-pole; shielded	1.5 m	756-5312/090-015	10
8-pole; shielded	5 m	756-5312/090-050	10
8-pole; shielded	10 m	756-5312/090-100	10

### Sensor/Actuator Cable; Fitted on both ends



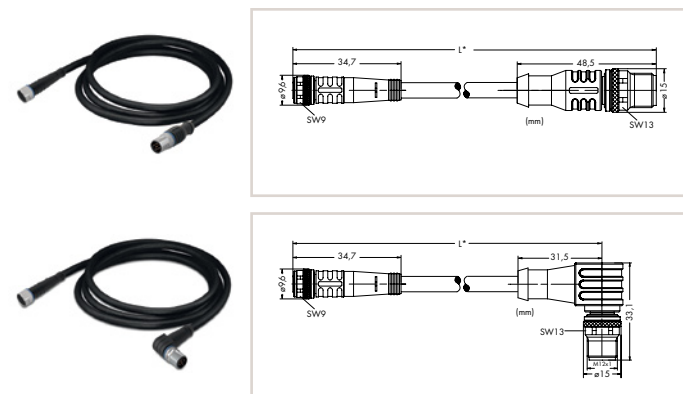
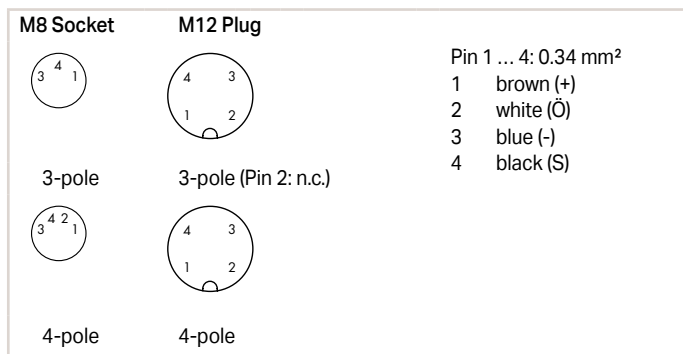
Operating voltage	60 VAC/DC
Operating current	4 A (max.)
Rated surge voltage	1.5 kV
Drag chain suitability	≥ 2 million bending cycles
Surrounding air temperature (operation), dynamic	-25 ... +90 °C
Protection type	IP67
Cable diameter	4.1 mm ±0.2

Sensor/Actuator Cable; M8 socket (straight) – M8 plug (straight)			
Pole No.	Cable Length	Item No.	Pack. Unit
3-pole	1 m	756-5201/030-010	10
3-pole	2 m	756-5201/030-020	10

Sensor/Actuator Cable; M8 socket (straight) – M8 plug (angled)			
Pole No.	Cable Length	Item No.	Pack. Unit
3-pole	1 m	756-5202/030-010	10
3-pole	2 m	756-5202/030-020	10

Sensor/Actuator Cable; M8 socket (angled) – M8 plug (straight)			
Pole No.	Cable Length	Item No.	Pack. Unit
3-pole	1 m	756-5203/030-010	10
3-pole	2 m	756-5203/030-020	10

Sensor/Actuator Cable; M8 socket (angled) – M8 plug (angled)			
Pole No.	Cable Length	Item No.	Pack. Unit
3-pole	1 m	756-5204/030-010	10
3-pole	2 m	756-5204/030-020	10



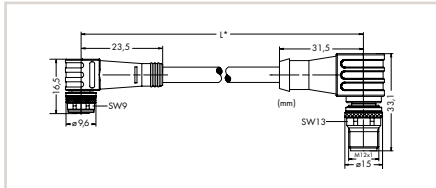
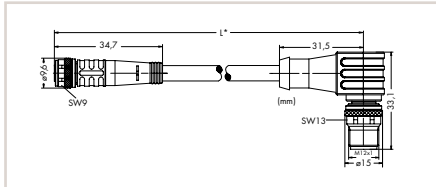
Operating voltage	60 VAC/DC
Operating current	4 A (max.)
Rated surge voltage	1.5 kV
Drag chain suitability	≥ 2 million bending cycles
Surrounding air temperature (operation), dynamic	-25 ... +90 °C
Protection type	IP67
Cable diameter	4.1 mm ±0.2

Sensor/Actuator Cable; M8 socket (straight) – M12 plug (straight)			
Pole No.	Cable Length	Item No.	Pack. Unit
3-pole	1 m	756-5507/030-010	10
3-pole	2 m	756-5507/030-020	10
4-pole	1 m	756-5507/040-010	10
4-pole	2 m	756-5507/040-020	10

Sensor/Actuator Cable; M8 socket (straight) – M12 plug (angled)			
Pole No.	Cable Length	Item No.	Pack. Unit
3-pole	1 m	756-5508/030-010	10
3-pole	2 m	756-5508/030-020	10
4-pole	1 m	756-5508/040-010	10
4-pole	2 m	756-5508/040-020	10

10

### Sensor/Actuator Cable; Fitted on both ends



#### Sensor/Actuator Cable; M8 socket (angled) – M12 plug (straight)

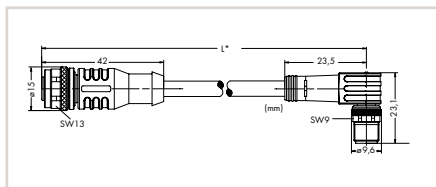
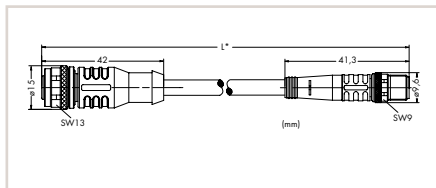
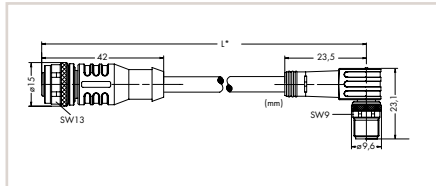
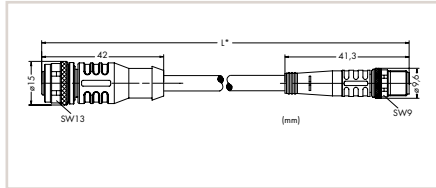
Pole No.	Cable Length	Item No.	Pack. Unit
3-pole	1 m	756-5509/030-010	10
3-pole	2 m	756-5509/030-020	10
4-pole	1 m	756-5509/040-010	10
4-pole	2 m	756-5509/040-020	10

#### Sensor/Actuator Cable; M8 socket (angled) – M12 plug (angled)

Pole No.	Cable Length	Item No.	Pack. Unit
3-pole	1 m	756-5510/030-010	10
3-pole	2 m	756-5510/030-020	10
4-pole	1 m	756-5510/040-010	10
4-pole	2 m	756-5510/040-020	10

M12 Socket	M8 Plug	
		Pin 1 ... 4: 0.34 mm <sup>2</sup>
		1 brown (+)
		3 blue (-)
		4 black (S)
3-pole	3-pole	

Operating voltage	60 VAC/DC
Operating current	4 A (max.)
Rated surge voltage	1.5 kV
Drag chain suitability	≥ 2 million bending cycles
Surrounding air temperature (operation), dynamic	-25 ... +90 °C
Protection type	IP67
Cable diameter	4.1 mm ±0.2



#### Sensor/Actuator Cable; M12 socket (straight) – M8 plug (straight)

Pole No.	Cable Length	Item No.	Pack. Unit
3-pole	1 m	756-5501/030-010	10
3-pole	2 m	756-5501/030-020	10

#### Sensor/Actuator Cable; M12 socket (straight) – M8 plug (angled)

Pole No.	Cable Length	Item No.	Pack. Unit
3-pole	1 m	756-5502/030-010	10
3-pole	2 m	756-5502/030-020	10

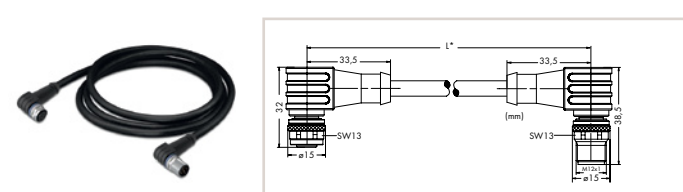
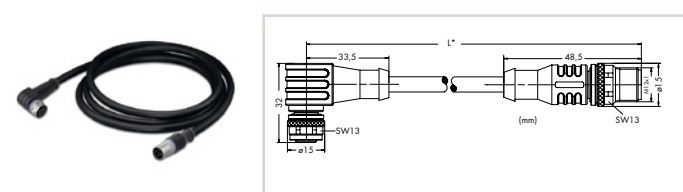
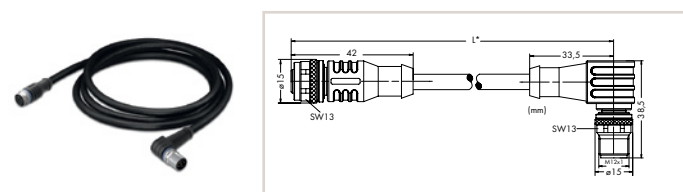
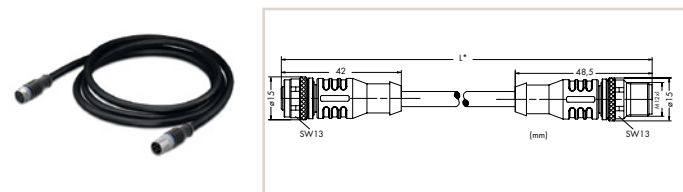
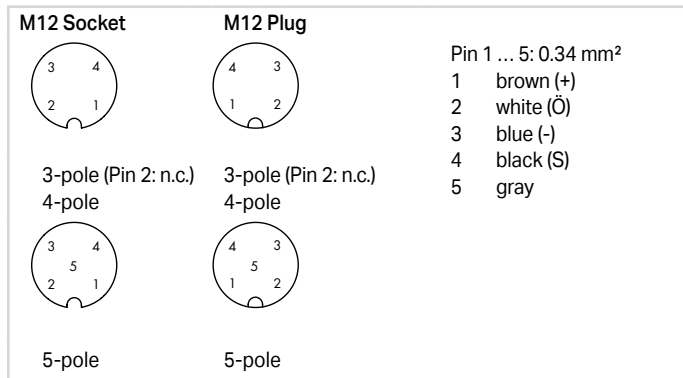
#### Sensor/Actuator Cable; M12 socket (angled) – M8 plug (straight)

Pole No.	Cable Length	Item No.	Pack. Unit
3-pole	1 m	756-5503/030-010	10
3-pole	2 m	756-5503/030-020	10

#### Sensor/Actuator Cable; M12 socket (angled) – M8 plug (angled)

Pole No.	Cable Length	Item No.	Pack. Unit
3-pole	1 m	756-5504/030-010	10
3-pole	2 m	756-5504/030-020	10

## Sensor/Actuator Cable; Fitted on both ends



Operating voltage	250 VAC/DC
Operating current	4 A (max.)
Rated surge voltage	2.5 kV (3-, 4-pole); 1.5 kV (5-pole)
Drag chain suitability	≥ 2 million bending cycles
Surrounding air temperature (operation), dynamic	-25 ... +90 °C
Protection type	IP67
Cable diameter	4.3 mm ±0.2 (3-pole); 4.7 mm ±0.2 (4-pole); 5.0 mm ±0.2 (5-pole); 6.5 mm ±0.2 (5-pole; shielded)

### Sensor/Actuator Cable; M12 socket (straight) – M12 plug (straight)

Pole No.	Cable Length	Item No.	Pack. Unit
3-pole	1 m	756-5401/030-010	10
3-pole	2 m	756-5401/030-020	10
4-pole	1 m	756-5401/040-010	10
4-pole	2 m	756-5401/040-020	10
5-pole	1 m	756-5401/050-010	10
5-pole	2 m	756-5401/050-020	10
5-pole; shielded	1 m	756-5401/060-010	10
5-pole; shielded	2 m	756-5401/060-020	10

### Sensor/Actuator Cable; M12 socket (straight) – M12 plug (angled)

Pole No.	Cable Length	Item No.	Pack. Unit
3-pole	1 m	756-5402/030-010	10
3-pole	2 m	756-5402/030-020	10
4-pole	1 m	756-5402/040-010	10
4-pole	2 m	756-5402/040-020	10
5-pole	1 m	756-5402/050-010	10
5-pole	2 m	756-5402/050-020	10
5-pole; shielded	1 m	756-5402/060-010	10
5-pole; shielded	2 m	756-5402/060-020	10

### Sensor/Actuator Cable; M12 socket (angled) – M12 plug (straight)

Pole No.	Cable Length	Item No.	Pack. Unit
3-pole	1 m	756-5403/030-010	10
3-pole	2 m	756-5403/030-020	10
4-pole	1 m	756-5403/040-010	10
4-pole	2 m	756-5403/040-020	10
5-pole	1 m	756-5403/050-010	10
5-pole	2 m	756-5403/050-020	10
5-pole; shielded	1 m	756-5403/060-010	10
5-pole; shielded	2 m	756-5403/060-020	10

### Sensor/Actuator Cable; M12 socket (angled) – M12 plug (angled)

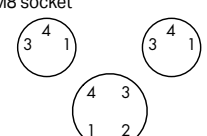
Pole No.	Cable Length	Item No.	Pack. Unit
3-pole	1 m	756-5404/030-010	10
3-pole	2 m	756-5404/030-020	10
4-pole	1 m	756-5404/040-010	10
4-pole	2 m	756-5404/040-020	10
5-pole	1 m	756-5404/050-010	10
5-pole	2 m	756-5404/050-020	10
5-pole; shielded	1 m	756-5404/060-010	10
5-pole; shielded	2 m	756-5404/060-020	10

10




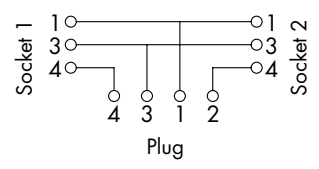
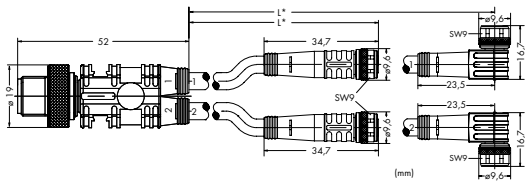
## Sensor/Actuator Cable; Fitted on Both Ends; Distribution Connector

2 x M8 socket



Pin 1 ... 4: 0.34 mm<sup>2</sup>

M12 Plug

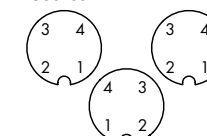




Operating voltage	60 VAC/DC
Operating current	4 A (max.)
Rated surge voltage	1.5 kV
Drag chain suitability	≥ 2 million bending cycles
Surrounding air temperature (operation), dynamic	-25 ... +90 °C
Protection type	IP67
Cable diameter	4.1 mm ±0.2

Sensor/Actuator Cable; 2 x M8 socket (straight) – M12 plug (straight)			
Pole No.	Cable Length	Item No.	Pack. Unit
4-pole	1 m	756-5513/040-010	10
4-pole	2 m	756-5513/040-020	10


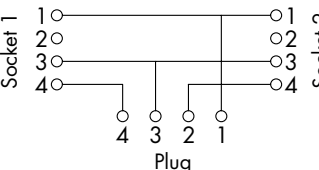
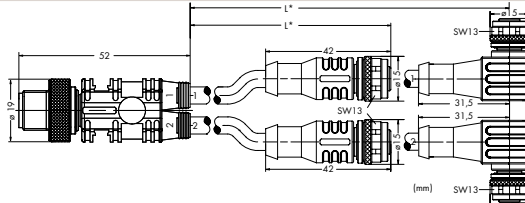
Sensor/Actuator Cable; 2 x M8 socket (angled) – M12 plug (straight)			
Pole No.	Cable Length	Item No.	Pack. Unit
4-pole	1 m	756-5514/040-010	10
4-pole	2 m	756-5514/040-020	10

2 x M12 Socket



Pin 1 ... 4: 0.34 mm<sup>2</sup>



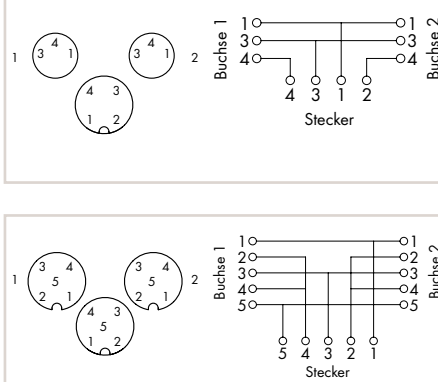
M12 Plug

Operating voltage	250 VAC/DC
Operating current	4 A (max.)
Rated surge voltage	2.5 kV
Drag chain suitability	≥ 2 million bending cycles
Surrounding air temperature (operation), dynamic	-25 ... +90 °C
Protection type	IP67
Cable diameter	4.7 mm ±0.2

Sensor/Actuator Cable; 2 x M12 socket (straight) – M12 plug (straight)			
Pole No.	Cable Length	Item No.	Pack. Unit
4-pole	1 m	756-5516/040-010	10
4-pole	2 m	756-5516/040-020	10

Sensor/Actuator Cable; 2 x M12 socket (angled) – M12 plug (straight)			
Pole No.	Cable Length	Item No.	Pack. Unit
4-pole	1 m	756-5517/040-010	10
4-pole	2 m	756-5517/040-020	10

Distribution Connector M8/M12		
	Item No.	Pack. Unit
Accessories; M12/M8 Distribution Connector	756-9301/040-000	1

Distribution Connector M12/M12		
	Item No.	Pack. Unit
Accessories; M12/M12 Distribution Connector	756-9301/050-000	1

## Configurable Connectors



Connectable cable:  
 Ø 4 ... 5 mm  
 0.14 ... 0.34 mm<sup>2</sup>

3-pole

### M8 Plug, Straight and Angled

	Item No.	Pack. Unit
Configurable Connectors; 3-pole; M8 plug (straight); IDC technology	756-9102/030-000	5
Configurable Connectors; 3-pole; M8 plug (angled); IDC technology	756-9105/030-000	5



Connectable cable:  
 Ø 4 ... 5 mm  
 0.14 ... 0.34 mm<sup>2</sup>

3-pole

### M8 Socket, Straight and Angled

	Item No.	Pack. Unit
Configurable Connectors; 3-pole; M8 socket (straight); IDC technology	756-9112/030-000	5
Configurable Connectors; 3-pole; M8 socket (angled); IDC technology	756-9115/030-000	5



Connectable cable:  
 Ø 4 ... 6 mm/0.25 ... 0.75 mm<sup>2</sup> (Screw clamp technology)  
 Ø 4 ... 6 mm/0.14 ... 0.50 mm<sup>2</sup> (Spring clamp technology)

4-pole

5-pole

### M12 Plug, Straight and Angled

	Item No.	Pack. Unit
Configurable Connectors; 4-pole; M12 plug (straight); Screw connection technology	756-9201/040-000	5
Configurable Connectors; 4-pole; M12 plug (angled); Screw connection technology	756-9204/040-000	5
Configurable Connectors; 4-pole; M12 plug (straight); Spring clamp technology	756-9202/040-000	5
Configurable Connectors; 4-pole; M12 plug (angled); Spring clamp technology	756-9205/040-000	5
Configurable Connectors; 5-pole; M12 plug (straight); Screw connection technology	756-9201/050-000	5
Configurable Connectors; 5-pole; M12 plug (angled); Screw connection technology	756-9204/050-000	5
Configurable Connectors; 5-pole; M12 plug (straight); Spring clamp technology	756-9202/050-000	5
Configurable Connectors; 5-pole; M12 plug (angled); Spring clamp technology	756-9205/050-000	5



Connectable cable:  
 Ø 4 ... 6 mm/0.25 ... 0.75 mm<sup>2</sup> (Screw clamp technology)  
 Ø 4 ... 6 mm/0.14 ... 0.50 mm<sup>2</sup> (Spring clamp technology)

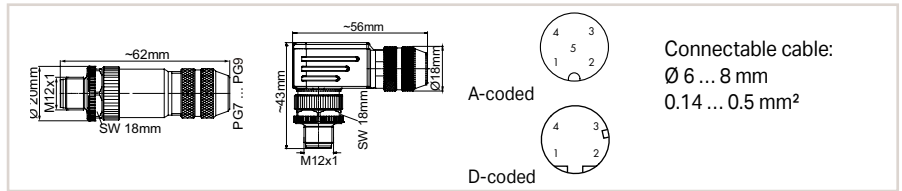
4-pole

5-pole

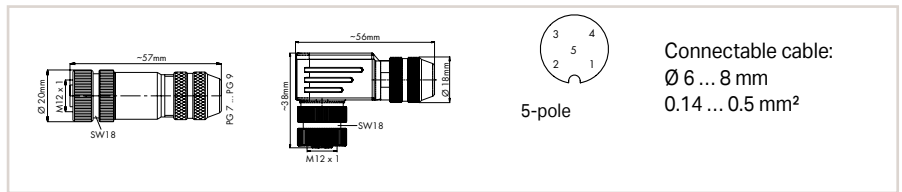
### M12 Socket, Straight and Angled

	Item No.	Pack. Unit
Configurable Connectors; 4-pole; M12 socket (straight); Screw connection technology	756-9211/040-000	5
Configurable Connectors; 4-pole; M12 socket (angled); Screw connection technology	756-9214/040-000	5
Configurable Connectors; 4-pole; M12 socket (straight); Spring clamp technology	756-9212/040-000	5
Configurable Connectors; 4-pole; M12 socket (angled); Spring clamp technology	756-9215/040-000	5
Configurable Connectors; 5-pole; M12 socket (straight); Spring clamp technology	756-9212/050-000	5
Configurable Connectors; 5-pole; M12 socket (angled); Spring clamp technology	756-9215/050-000	5

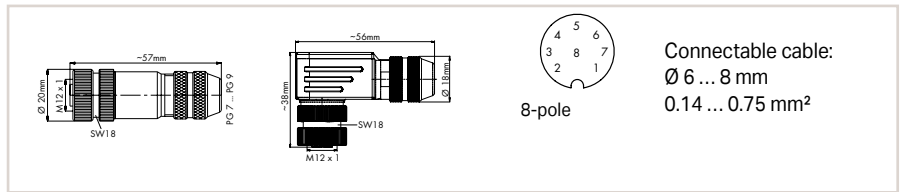
## Configurable Shielded Connectors



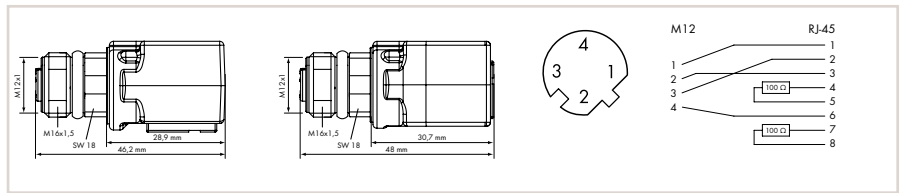
M12 Plug, Straight and Angled		Item No.	Pack. Unit
Configurable Connectors; 5-pole; Shielded; M12 plug (straight); A-coded; Spring clamp technology		756-9207/060-000	1
Configurable Connectors; 4-pole; Shielded; M12 plug (straight); D-coded; Spring clamp technology		756-9501/060-000	1
Configurable Connectors; 5-pole; Shielded; M12 plug (angled); A-coded; Spring clamp technology		756-9211/060-000	1
Configurable Connectors; 4-pole; Shielded; M12 plug (angled); D-coded; Spring clamp technology		756-9501/040-000	1



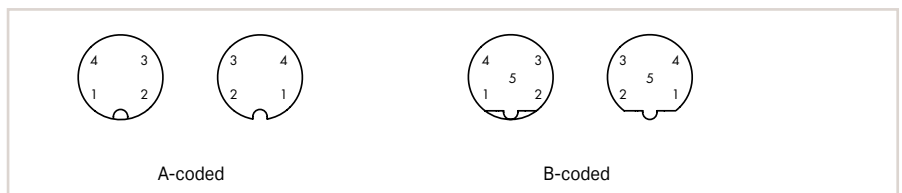
M12 Socket, Straight and Angled		Item No.	Pack. Unit
Configurable Connectors; 5-pole; Shielded; M12 socket (straight); Spring clamp technology		756-9208/060-000	1
Configurable Connectors; 5-pole; Shielded; M12 socket (angled); Spring clamp technology		756-9210/060-000	1



M12 Socket, Straight and Angled		Item No.	Pack. Unit
Configurable Connectors; 8-pole; Shielded; M12 socket (straight); Screw connection technology		756-9211/090-000	1
Configurable Connectors; 8-pole; Shielded; M12 socket (angled); Screw connection technology		756-9214/090-000	1



Adapter M12 Socket/ RJ-45 Socket		Item No.	Pack. Unit
Adapter M12 socket; D-coded/ RJ-45 socket; angled		756-9503/040-000	1
Adapter M12 socket; D-coded/ RJ-45 socket; straight		756-9504/040-000	1



M12 Panel Feed-through Connector		Item No.	Pack. Unit
M12 panel feed-through connector; 4-pole; M12 socket; A-coded		756-9217/050-000	1
M12 panel feed-through connector; 5-pole; M12 socket; B-coded		756-9406/050-000	1

## Torque Wrench M8 and M12; Assembly Kit



Assembly kit for pre-assembled IP67 cables and hex nut connectors (756 Series), consists of:

- Tool kit
- Torque screwdriver with adjustable torque (window scale)
- Adjustment tool for changing the torque
- Socket wrench SW9 (for M8 cable assemblies)
- Socket wrench SW13 (for M12 cable assemblies)

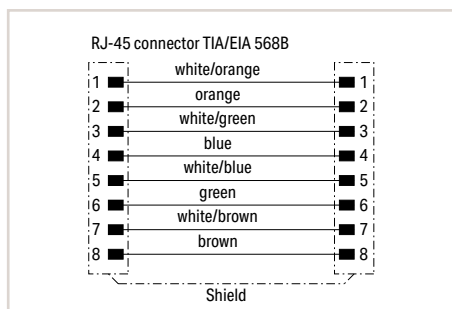
A torque specification of 0.6 Nm for M8 connectors and 1.0 Nm for M12 connectors is required for 756 Series Cables and Connectors.

Torque Wrench M8 and M12; Assembly Kit		
	Item No.	Pack. Unit
	206-701	1

Torque range	0,4 ... 1 Nm ±6 %
Material	
Handle	Polypropylene (PP) for hard zone; Thermoplastic elastomers (TPE) for soft zone
Allen key	Polyamide (PA), glass-fiber-reinforced; Chrome-vanadium-molybdenum steel (CrMoV) (1.2381)
Adjustment tool	Cellulose acetate; Chrome-vanadium-molybdenum steel (CrMoV) (1.2381)
Color	Black
Standards/specifications	EN ISO 6789; BS EN 26789; ASME B107.14.M

# ETHERNET Cable; Cat. 6A S/FTP



Item Description
Version

ETHERNET Cable; Cat. 6A; RJ-45; RJ-45		
Cable Length	Item No.	Pack. Unit
0.5 m	756-1250/1013-005	1
1 m	756-1250/1013-010	1
2 m	756-1250/1013-020	1
3 m	756-1250/1013-030	1
5 m	756-1250/1013-050	1
7.5 m	756-1250/1013-075	1
10 m	756-1250/1013-100	1

ETHERNET Cable; Cat. 6A; RJ-45; RJ-45		
Axial unlocking		
Cable Length	Item No.	Pack. Unit
0.5 m	756-1250/1023-005	1
1 m	756-1250/1023-010	1
2 m	756-1250/1023-020	1
3 m	756-1250/1023-030	1
5 m	756-1250/1023-050	1
7.5 m	756-1250/1023-075	1
10 m	756-1250/1023-100	1

Technical Data	
Transmission	10 Gbit/s (500 MHz)
Operating voltage	80 V
Operating current	720 mA
Rated surge voltage	500 V (wire/wire/screen rms 50 Hz 1 min)
Insulation resistance	≥ 1x108 Ωxkm
Resistance of conductor	< 142 Ω/km
Surrounding air temperature (operation)	-40 ... +80 °C (static and moving)
Bending radius	10 mm (min.)
Bending cycles	≥ 8500
Cable	S/FTP 4x2xAWG26/7
Overall shield	Overlapped aluminum-laminated foil and tinned copper braid (PiMF)
Conductor	Bare copper wire (7 x 0.16 mm)
Conductor insulation	Halogen-free PE
Outer jacket	LSOH TPE; halogen-free per IEC 60754-2; flame-retardant per IEC 60332-1; low-smoke per IEC 61034
Color	Green (RAL 6018)
Cable diameter	Ø 6.2 mm ±0.2
Plug	2 x Cat. 6A RJ-45
Contact material	CuZn
Contact plating	CuNi/Au; 50 µin gold plating
Mech. service life	> 1200 mating cycles
Data sheet and further information, see:	<a href="http://wago.com/756-1250">wago.com/756-1250</a>

Transmission	10 Gbit/s (500 MHz)
Operating voltage	80 V
Operating current	720 mA
Rated surge voltage	500 V (wire/wire/screen rms 50 Hz 1 min)
Insulation resistance	≥ 1x108 Ωxkm
Resistance of conductor	< 142 Ω/km
Surrounding air temperature (operation)	-40 ... +80 °C (static and moving)
Bending radius	10 mm (min.)
Bending cycles	≥ 8500
Cable	S/FTP 4x2xAWG26/7
Overall shield	Overlapped aluminum-laminated foil and tinned copper braid (PiMF)
Conductor	Bare copper wire (7 x 0.16 mm)
Conductor insulation	Halogen-free PE
Outer jacket	LSOH TPE; halogen-free per IEC 60754-2; flame-retardant per IEC 60332-1; low-smoke per IEC 61034
Color	Green (RAL 6018)
Cable diameter	Ø 6.2 mm ±0.2
Plug	2 x Cat. 6A RJ-45
Contact material	CuZn
Contact plating	CuNi/Au; 50 µin gold plating
Mech. service life	> 1200 mating cycles
Data sheet and further information, see:	<a href="http://wago.com/756-1250">wago.com/756-1250</a>

Short description:

- Halogen-free TPE
- Cat. 6A S/FTP
- Highly flexible
- 50 µin gold plating in the contact area
- Mechanically/electrically tested
- 4C Channel Link Test
- Wrap-around label for clear traceability
- Easy plug unlocking (756-1250/1023-xxx)

## Bluetooth® Adapter



Item Description	Bluetooth® Adapter
Item No.	750-921
Order Text	Bluetooth® Adapter
<b>Technical Data</b>	
Transmission range	20 m in open air (Class 2)*
Data transmission rate	9600 ... 115000 bit/s
Frequency range	ISM band; 2402 ... 2483 MHz
Type of communication	Peer-to-peer connection
Supported profiles	Serial Port Profile (SPP)
Radio technology	Bluetooth® 2.1
Antenna	Integrated
Connectors	4-pole service connectors
Configuration	AT commands (e.g., via HyperTerminal)
Function	Master or slave
LED	Operating mode
Security encryption	128-bit encryption
Surrounding air temperature (operation)	-20 ... +60 °C
Dimensions W x H x D	15 x 50 x 19 mm
<b>Approvals</b>	Bluetooth® approval; 1
Data sheet and further information, see:	<a href="http://wago.com/750-921">wago.com/750-921</a>

The *Bluetooth®* Adapter wirelessly connects a notebook computer with *Bluetooth®* functionality to the service interface of the fieldbus coupler/controller. It also provides an active connection to a controller.

As a cable substitute, the *Bluetooth®* Adapter allows communication between two controllers, as well as between fieldbus couplers/controllers via WAGO Software Tools.

The adapter is supplied via both service interface and power supply of the coupler/controller.

\*The maximum range in the field decreases within buildings and varies depending on building materials and spatial geometry. Therefore, range specifications within buildings can only represent a typical value that can normally be achieved. More detailed information is available in the manual.

## WAGO Communication Cables



<b>Item Description</b>	<b>RS-232 Communication Cable; RS-232 (D-sub; 9-pole); Service Interface I/O System 750</b>	
<b>Item No.</b>	<b>750-920</b>	
<b>Order Text</b>	Communication Cable	
<b>Technical Data</b>		
Connectors	4-pole service connectors	
Cable Length	2.5 m	
Surrounding air temperature (operation)	0 ... +55 °C	
Protection type	IP20	
<b>Data sheet and further information, see:</b>	<a href="http://wago.com/750-920">wago.com/750-920</a>	

This communication cable connects the engineering software to the controller or fieldbus coupler.

NOTICE: The communication cable must not be connected or removed when energized.



<b>Item Description</b>	<b>USB Communication Cable; USB-A; Service Interface I/O System 750</b>	
<b>Version</b>	<b>2.5 m</b>	<b>5 m</b>
<b>Item No.</b>	<b>750-923</b>	<b>750-923/000-001</b>
<b>Order Text</b>	CONF-CABLE; USB; 2.5m	CONF-CABLE; USB; 5m
<b>Technical Data</b>		
USB specification	2.0 compatible/full-speed device	
Operating system	Microsoft® Windows® 2000; Microsoft® Windows® XP Professional; Microsoft® Windows® Vista®; Microsoft® Windows® 7	
USB interface	Type A/m	
Cable Length	2.5 m	5 m
Surrounding air temperature (operation)	-25 ... +70 °C	
<b>Approvals</b>	CE	
<b>Data sheet and further information, see:</b>	<a href="http://wago.com/750-923">wago.com/750-923</a>	

This USB communication cable connects the engineering software to the controller or fieldbus coupler.

Notice: A specific firmware version is required to connect the 759-923 USB Communication Cable to some particular controllers.

## Memory Cards



Item Description	Memory Card microSD; SLC-NAND; 2 GB; Temperature range: -40 ... +90 °C	Memory Card SD; SLC-NAND; 2 GB; Temperature range: -40 ... +90 °C
Item No.	758-879/000-3102	758-879/000-001
<b>Technical Data</b>		
Memory	2 GB (SLC)	2 GB (SLC)
Read/write cycles (max.)	17 MB/s / 20 MB/s	16 Mb/s / 22 Mb/s
MTBF	4,000,000 hrs.	4,000,000 hrs.
service life	2,000,000 program/operating cycles	2,000,000 program/operating cycles
Surrounding air temperature (operation)	-40 ... +90 °C	-45 ... +90 °C
Surrounding air temperature (storage)	-40 ... +90 °C	-45 ... +90 °C
Relative humidity	95 %; non condensing	95 %; non condensing
Dimensions W x H x D	15 x 11 x 1 mm	24 x 32 x 2.1 mm
Vibration resistance	15g	15g
Shock resistance	50g	50g (operating), 1000g (not operating)
Data transmission rate	Up to 20 MB/s	Up to 22 MB/s



## Antennas



**Self-Adhesive Antenna; with 2.5 m cable and SMA straight plug; GSM/UMTS/LTE/Bluetooth®/WLAN; 699-960, 1710-2690 MHz**

**Item No.** 758-961

### Technical Data

Frequency band	699 ... 960 MHz 1710 ... 2690 MHz
Dimensions W x H	117 x 12 mm
Cable length	2.5 m
Cable type	RG174
Gain	2.15 dBi
VSWR	< 1.5
Connector	SMA straight plug



**Theft-Proof Antenna; with 1 m cable and SMA straight plug; GSM/UMTS/BT/WLAN; 850/900/1800/1900/2100/2400 MHz**

**Item No.** 758-962

### Technical Data

Frequency band	850 / 900 / 1800 / 1900 / 2100 MHz
Dimensions W x H	29 x 52 mm
Cable length	1 m
Cable type	RG174
Gain	2 dBi
VSWR	< 2
Connector	SMA straight plug



**Rod Antenna; with 1 m cable and SMA straight plug; GSM UMTS; 850/900/1800/1900/2100 MHz**

**Item No.** 758-963

### Technical Data

Frequency band	850 / 900 / 1800 / 1900 / 2100 MHz
Dimensions (height)	298 mm
Cable length	1 m
Cable type	RG58
Gain	2.2 dBi
VSWR	< 1.6
Connector	SMA straight plug



**Magnetic-Mount Antenna; with 2.5 m cable and SMA straight plug; GSM UMTS; 850/900/1800/1900/2100 MHz**

**Item No.** 758-965

### Technical Data

Frequency band	850 / 900 / 1800 / 1900 / 2100 MHz
Dimensions (height)	88 mm
Cable length	2.5 m
Cable type	RG174
Gain	2.2 dBi
VSWR	< 2
Connector	SMA straight plug



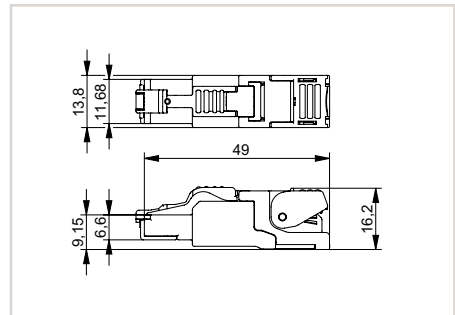
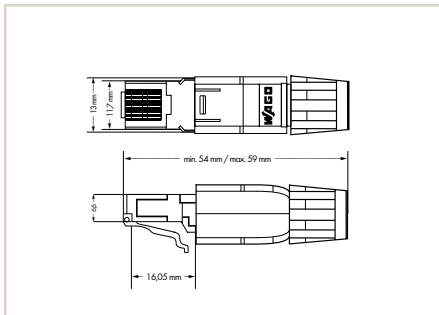
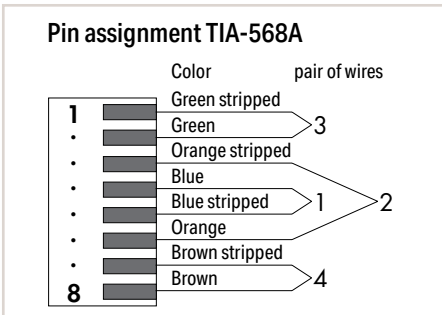
**Theft-Proof Combination Antenna; with 2.5 m cable and SMA straight plug; GSM UMTS; 850/900/1800/1900/2100 MHz**

**Item No.** 758-966

### Technical Data

Frequency band	850 / 900 / 1800 / 1900 / 2100 MHz
Dimensions W x H	29 x 52 mm
Cable length	2.5 m
Cable type	RG174
Gain	2 dBi
VSWR	< 2
Connector	SMA straight plug

# ETHERNET Connector; Code T568A



<b>Item Description</b>
<b>Version</b>
<b>Item No.</b>
<b>Order Text</b>

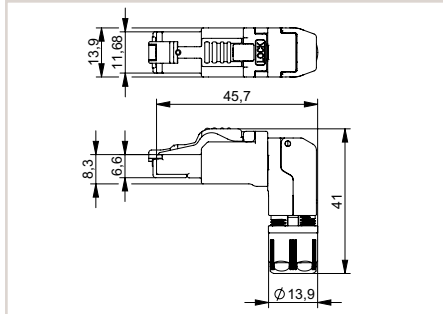
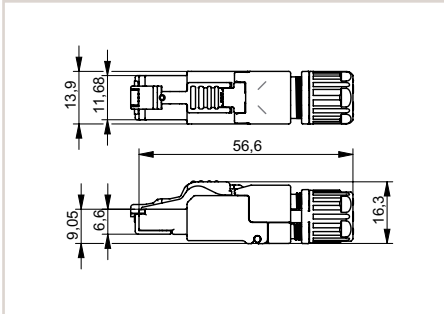
<b>ETHERNET Connector; RJ-45; Cat. 5; Straight; Code T568A</b>
<b>AWG22</b>
<b>750-975</b>
Connector ETHERNET; RJ45; Cat.5; 180°; T568A AWG22

<b>ETHERNET Connector; RJ-45; Cat. 6A; Straight; Code T568A</b>	
<b>AWG22</b>	<b>AWG24</b>
<b>750-977/000-011</b>	<b>750-977/000-021</b>
Connector ETHERNET; RJ-45; Cat.6A; 180°; T568A; AGW22	Connector ETHERNET; RJ-45; Cat.6A; 180°; T568A; AGW24

<b>Technical Data</b>	
Cable category	Cat. 5e
Data transmission rate (max.)	1 GBit/s
Code	TiA-568A
Cable exit	180°
Pole No.	8
Housing material	Plastic
Mating cycles	> 1000
Conductor connection	IDC (Insulation Displacement Contact)
Conductor cross sections	Solid: 0.13 ... 0.24 mm <sup>2</sup> / 26/1 ... 23/1 AWG; Stranded: 0.14 ... 0.36 mm <sup>2</sup> / 26/7 ... 22/7 AWG
Cable jacket diameter	4.5 ... 8 mm
Cable strain relief	Screw clamp connection
Shield connection	> 180°
Surrounding air temperature (operation)	-20 ... +70 °C
Surrounding air temperature (storage)	-40 ... +70 °C
Relative humidity	95 %; non condensing
Protection type	IP20
Standards/specifications	Basic standard: IEC 60603-7 RJ-45 Category 5; CD ISO/IEC 11801: 2002; EN 50173: 2002; EIA/TIA 568A: 2002; UL 1863
Approvals	Marine
Data sheet and further information, see:	<a href="http://wago.com/750-975">wago.com/750-975</a>

<b>ETHERNET Connector; RJ-45; Cat. 6A; Straight; Code T568A</b>	
Cable category	Cat. 6A
Data transmission rate (max.)	10 GBit/s
Code	TiA-568A
Cable exit	180°
Pole No.	8
Housing material	Zinc die-cast
Mating cycles	> 750
Conductor connection	IDC (Insulation Displacement Contact)
Conductor cross sections	Solid: 0.21 ... 0.32 mm <sup>2</sup> / 24/1 ... 22/1 AWG; Stranded: 0.11 ... 0.36 mm <sup>2</sup> / 27/7 ... 22/7 AWG
Cable jacket diameter	5.5 ... 9 mm
Cable strain relief	Screw clamp connection
Shield connection	> 180°
Surrounding air temperature (operation)	-40 ... +85 °C
Surrounding air temperature (storage)	-40 ... +85 °C
Relative humidity	95 %; non condensing
Protection type	IP20
Standards/specifications	IEC60603-7-51; ISO/IEC 11801; IEEE 802.3an; EIA/TIA 568-C.2; DIN EN 50173-1; UL 1863; UL 2043
Approvals	Marine
Data sheet and further information, see:	<a href="http://wago.com/750-977/000-011">wago.com/750-977/000-011</a>

<b>ETHERNET Connector; RJ-45; Cat. 6A; Straight; Code T568A</b>	
Cable category	Cat. 6A
Data transmission rate (max.)	10 GBit/s
Code	TiA-568A
Cable exit	180°
Pole No.	8
Housing material	Zinc die-cast
Mating cycles	> 750
Conductor connection	IDC (Insulation Displacement Contact)
Conductor cross sections	Solid: 0.13 ... 0.21 mm <sup>2</sup> / 26/1 ... 24/1 AWG; Stranded: 0.11 ... 0.23 mm <sup>2</sup> / 27/7 ... 24/7 AWG
Cable jacket diameter	5.5 ... 9 mm
Cable strain relief	Screw clamp connection
Shield connection	> 180°
Surrounding air temperature (operation)	-40 ... +85 °C
Surrounding air temperature (storage)	-40 ... +85 °C
Relative humidity	95 %; non condensing
Protection type	IP20
Standards/specifications	IEC60603-7-51; ISO/IEC 11801; IEEE 802.3an; EIA/TIA 568-C.2; DIN EN 50173-1; UL 1863; UL 2043
Approvals	Marine
Data sheet and further information, see:	<a href="http://wago.com/750-977/000-021">wago.com/750-977/000-021</a>



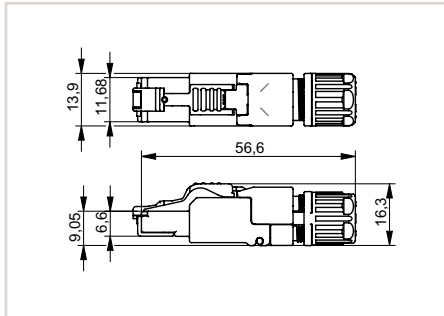
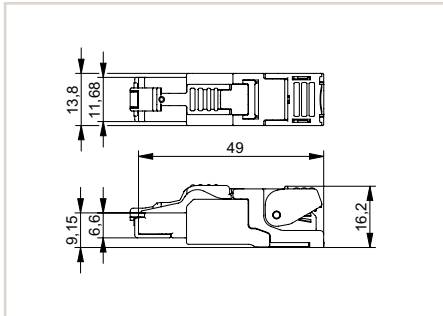
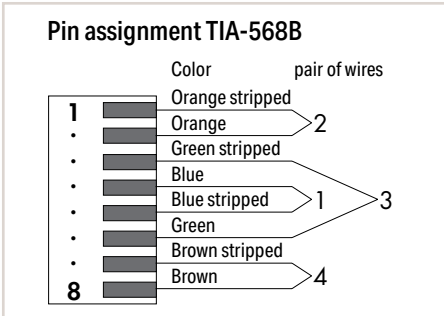
<b>ETHERNET Connector; RJ-45; Cat. 6A; Straight; Code T568A; Strain relief</b>	
<b>AWG22</b>	<b>AWG24</b>
750-978/000-011	750-978/000-021
Connector ETHERNET; RJ-45; Cat.6A; 180°; T568A; AGW22; Strain relief	Connector ETHERNET; RJ-45; Cat.6A; 180°; T568A; AGW24; Strain relief

<b>ETHERNET Connector; RJ-45; Cat. 6A; Angled; Code T568A; Strain relief</b>	
<b>AWG22</b>	<b>AWG24</b>
750-979/000-011	750-979/000-021
Connector ETHERNET; RJ-45; Cat.6A; 90°; T568A; AGW22; Strain relief	Connector ETHERNET; RJ-45; Cat.6A; 90°; T568A; AGW24; Strain relief

Cat. 6A	
10 GBit/s	
TiA-568A	
180°	
8	
Zinc die-cast	
> 750	
IDC (Insulation Displacement Contact)	
Solid: 0.21 ... 0.32 mm <sup>2</sup> / 24/1 ... 22/1 AWG;	Solid: 0.13 ... 0.21 mm <sup>2</sup> / 26/1 ... 24/1 AWG;
Stranded: 0.11 ... 0.36 mm <sup>2</sup> / 27/7 ... 22/7 AWG	Stranded: 0.11 ... 0.23 mm <sup>2</sup> / 27/7 ... 24/7 AWG
5.5 ... 10 mm	
Screw clamp connection	
360°	
-40 ... +85 °C	
-40 ... +85 °C	
95 %; non condensing	
IP20	
IEC60603-7-51; ISO/IEC 11801; IEEE 802.3an; EIA/TIA 568-C.2; DIN EN 50173-1; UL 1863; UL 2043	
wago.com/ 750-978/000-011	wago.com/ 750-978/000-021

Cat. 6A	
10 GBit/s	
TiA-568A	
90°; selectable position	
8	
Zinc die-cast	
> 750	
IDC (Insulation Displacement Contact)	
Solid: 0.21 ... 0.32 mm <sup>2</sup> / 24/1 ... 22/1 AWG;	Solid: 0.13 ... 0.21 mm <sup>2</sup> / 26/1 ... 24/1 AWG;
Stranded: 0.11 ... 0.36 mm <sup>2</sup> / 27/7 ... 22/7 AWG	Stranded: 0.11 ... 0.23 mm <sup>2</sup> / 27/7 ... 24/7 AWG
5.5 ... 10 mm	
Screw clamp connection	
360°	
-40 ... +85 °C	
-40 ... +85 °C	
95 %; non condensing	
IP20	
IEC60603-7-51; ISO/IEC 11801; IEEE 802.3an; EIA/TIA 568-C.2; DIN EN 50173-1; UL 1863; UL 2043	
wago.com/ 750-979/000-011	wago.com/ 750-979/000-021

# ETHERNET Connector; Code T568B

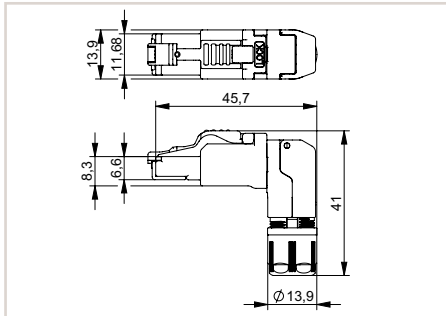


Item Description	ETHERNET Connector; RJ-45; Cat. 6A; Straight; Code T568B		ETHERNET Connector; RJ-45; Cat. 6A; Straight; Code T568B; Strain relief	
Version				
Item No.	750-977/000-012	750-977/000-022	750-978/000-012	750-978/000-022
Order Text	Connector ETHERNET; RJ-45; Cat.6A; 180°; T568B; AWG22	Connector ETHERNET; RJ-45; Cat.6A; 180°; T568B; AWG24	Connector ETHERNET; RJ-45; Cat.6A; 180°; T568B; AWG22; Strain relief	Connector ETHERNET; RJ-45; Cat.6A; 180°; T568B; AWG24; Strain relief

Technical Data	ETHERNET Connector; RJ-45; Cat. 6A; Straight; Code T568B		ETHERNET Connector; RJ-45; Cat. 6A; Straight; Code T568B; Strain relief	
Cable category	Cat. 6A		Cat. 6A	
Data transmission rate (max.)	10 GBit/s		10 GBit/s	
Code	TIA-568B		TIA-568B	
Cable exit	180°		180°	
Pole No.	8		8	
Housing material	Zinc die-cast		Zinc die-cast	
Mating cycles	> 750		> 750	
Conductor connection	IDC (Insulation Displacement Contact)		IDC (Insulation Displacement Contact)	
Conductor cross sections	Solid: 0.21 ... 0.32 mm <sup>2</sup> / 24/1 ... 22/1 AWG; Stranded: 0.11 ... 0.36 mm <sup>2</sup> / 27/7 ... 22/7 AWG	Solid: 0.13 ... 0.21 mm <sup>2</sup> / 26/1 ... 24/1 AWG; Stranded: 0.11 ... 0.23 mm <sup>2</sup> / 27/7 ... 24/7 AWG	Solid: 0.21 ... 0.32 mm <sup>2</sup> / 24/1 ... 22/1 AWG; Stranded: 0.11 ... 0.36 mm <sup>2</sup> / 27/7 ... 22/7 AWG	Solid: 0.13 ... 0.21 mm <sup>2</sup> / 26/1 ... 24/1 AWG; Stranded: 0.11 ... 0.23 mm <sup>2</sup> / 27/7 ... 24/7 AWG
Cable jacket diameter	5.5 ... 9 mm		5.5 ... 10 mm	
Cable strain relief			Screw clamp connection	
Shield connection	360°		360°	
Surrounding air temperature (operation)	-40 ... +85 °C		-40 ... +85 °C	
Surrounding air temperature (storage)	-40 ... +85 °C		-40 ... +85 °C	
Relative humidity	95 %; non condensing		95 %; non condensing	
Protection type	IP20		IP20	
Standards/specifications	IEC60603-7-51; ISO/IEC 11801; IEEE 802.3an; EIA/TIA 568-C.2; DIN EN 50173-1; UL 1863; UL 2043		IEC60603-7-51; ISO/IEC 11801; IEEE 802.3an; EIA/TIA 568-C.2; DIN EN 50173-1; UL 1863; UL 2043	

Approvals	ETHERNET Connector; RJ-45; Cat. 6A; Straight; Code T568B		ETHERNET Connector; RJ-45; Cat. 6A; Straight; Code T568B; Strain relief	
Data sheet and further information, see:	wago.com/ 750-977/000-012	wago.com/ 750-977/000-022	wago.com/ 750-978/000-012	wago.com/ 750-978/000-022

10

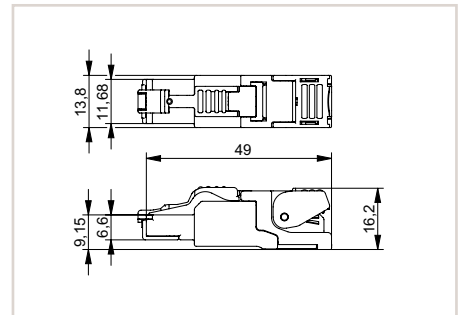
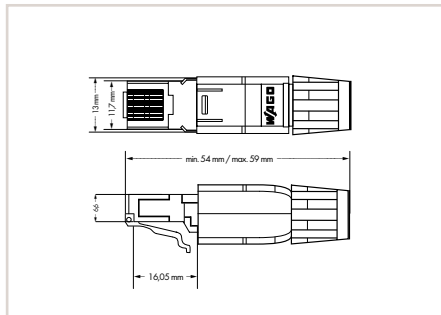
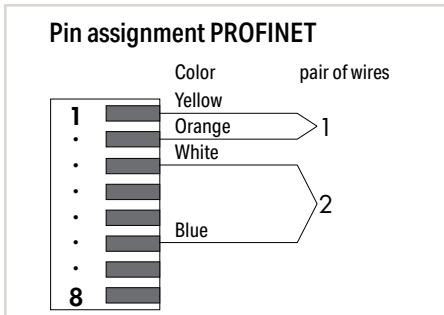


**ETHERNET Connector; RJ-45; Cat. 6A; Angled; Code T568B; Strain relief**

AWG22	AWG24
750-979/000-012	750-979/000-022
Connector ETHERNET; RJ-45; Cat.6A; 90°; T568B; AWG22; Strain relief	Connector ETHERNET; RJ-45; Cat.6A; 90°; T568B; AWG24; Strain relief

Cat. 6A	
10 GBit/s	
TiA-568B	
90°; selectable position	
8	
Zinc die-cast	
> 750	
IDC (Insulation Displacement Contact)	
Solid: 0.21 ... 0.32 mm <sup>2</sup> / 24/1 ... 22/1 AWG;	Solid: 0.13 ... 0.21 mm <sup>2</sup> / 26/1 ... 24/1 AWG;
Stranded: 0.11 ... 0.36 mm <sup>2</sup> / 27/7 ... 22/7 AWG	Stranded: 0.11 ... 0.23 mm <sup>2</sup> / 27/7 ... 24/7 AWG
5.5 ... 10 mm	
Screw clamp connection	
360°	
-40 ... +85 °C	
-40 ... +85 °C	
95 %; non condensing	
IP20	
IEC60603-7-51; ISO/IEC 11801; IEEE 802.3an; EIA/TIA 568-C.2; DIN EN 50173-1; UL 1863; UL 2043	
wago.com/ 750-979/000-012	wago.com/ 750-979/000-022

# PROFINET Connector



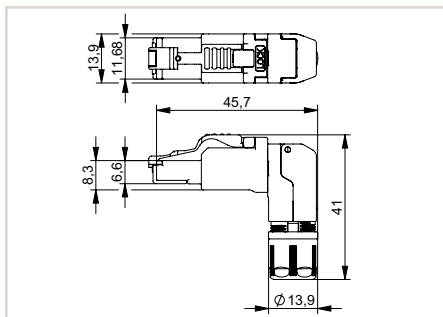
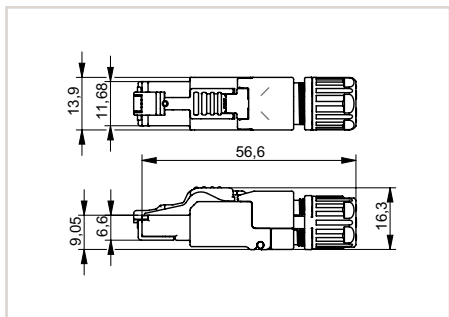
<b>Item Description</b>
<b>Version</b>
<b>Item No.</b>
<b>Order Text</b>

<b>PROFINET Connector ; RJ-45; Cat. 5; Straight</b>
<b>AWG 22</b>
<b>750-976</b>
Connector PROFINET; RJ-45; Cat.5; 180°; AWG22

<b>PROFINET Connector ; RJ-45; Cat. 6A; Straight</b>
<b>AWG 22</b>
<b>750-977/000-013</b>
Connector PROFINET; RJ-45; Cat.6A; 180°; AWG22

Technical Data	
Cable category	Cat. 5e
Data transmission rate (max.)	100 MBit/s
Code	PROFINET
Cable exit	180°
Pole No.	8
Housing material	Plastic
Mating cycles	> 1000
Conductor connection	IDC (Insulation Displacement Contact)
Conductor cross sections	Solid: 0.13 ... 0.24 mm <sup>2</sup> / 26/1 ... 23/1 AWG; Stranded: 0.14 ... 0.36 mm <sup>2</sup> / 26/7 ... 22/7 AWG
Cable jacket diameter	4.5 ... 8 mm
Cable strain relief	Screw clamp connection
Shield connection	>180°
Surrounding air temperature (operation)	-20 ... +70 °C
Surrounding air temperature (storage)	-40 ... +70 °C
Relative humidity	95 %; non condensing
Protection type	IP20
Standards/specifications	Basic standard: IEC 60603-7 RJ-45 Category 5; CD ISO/IEC 11801: 2002; EN 50173: 2002; EIA/TIA 568A: 2002; UL 1863
<b>Approvals</b>	Marine
<b>Data sheet and further information, see:</b>	<a href="http://wago.com/750-976">wago.com/750-976</a>

Cat. 6A
100 MBit/s
PROFINET
180°
8
Zinc die-cast
> 750
IDC (Insulation Displacement Contact)
Solid: 0.21 ... 0.32 mm <sup>2</sup> / 24/1 ... 22/1 AWG; Stranded: 0.11 ... 0.36 mm <sup>2</sup> / 27/7 ... 22/7 AWG
5.5 ... 9 mm
360°
-40 ... +85 °C
-40 ... +85 °C
95 %; non condensing
IP20
IEC60603-7-51; ISO/IEC 11801; IEEE 802.3an; EIA/TIA 568-C.2; DIN EN 50173-1; UL 1863; UL 2043
<a href="http://wago.com/750-977/000-013">wago.com/750-977/000-013</a>



**PROFINET Connector ; RJ-45; Cat. 6A; Straight; Strain relief**

**AWG 22**

**750-978/000-013**

Connector PROFINET; RJ-45; Cat.6A; 180°; AWG22; Strain relief

**PROFINET Connector ; RJ-45; Cat. 6A; Angled; Strain relief**

**AWG 22**

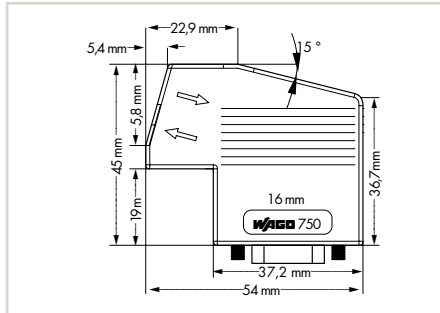
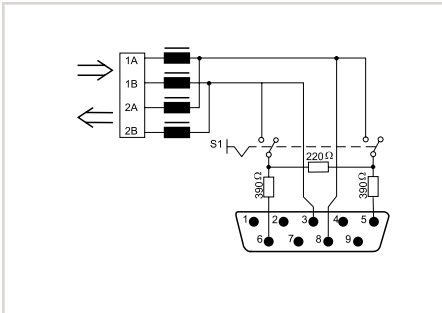
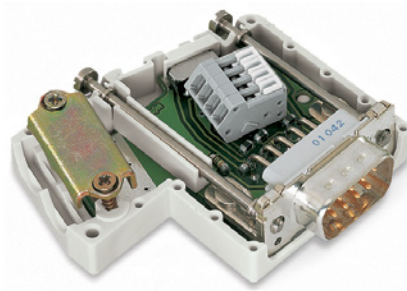
**750-979/000-013**

Connector PROFINET; RJ-45; Cat.6A; 90°; AWG22; Strain relief

Cat. 6A
100 MBit/s
PROFINET
180°
8
Zinc die-cast
> 750
IDC (Insulation Displacement Contact)
Solid: 0.21 ... 0.32 mm <sup>2</sup> / 24/1 ... 22/1 AWG;
Stranded: 0.11 ... 0.36 mm <sup>2</sup> / 27/7 ... 22/7 AWG
5.5 ... 10 mm
Screw clamp connection
360°
-40 ... +85 °C
-40 ... +85 °C
95 %; non condensing
IP20
IEC60603-7-51; ISO/IEC 11801; IEEE 802.3an;
EIA/TIA 568-C.2; DIN EN 50173-1;
UL 1863; UL 2043
<a href="http://wago.com/750-978/000-013">wago.com/750-978/000-013</a>

Cat. 6A
100 MBit/s
PROFINET
90°; selectable position
8
Zinc die-cast
> 750
IDC (Insulation Displacement Contact)
Solid: 0.21 ... 0.32 mm <sup>2</sup> / 24/1 ... 22/1 AWG;
Stranded: 0.11 ... 0.36 mm <sup>2</sup> / 27/7 ... 22/7 AWG
5.5 ... 10 mm
Screw clamp connection
360°
-40 ... +85 °C
-40 ... +85 °C
95 %; non condensing
IP20
IEC60603-7-51; ISO/IEC 11801; IEEE 802.3an;
EIA/TIA 568-C.2; DIN EN 50173-1;
UL 1863; UL 2043
<a href="http://wago.com/750-979/000-013">wago.com/750-979/000-013</a>

# PROFIBUS Fieldbus Connector



**Item Description**  
**Item No.**  
**Order Text**

**PROFIBUS Fieldbus Connector; D-sub; 9-pole**  
**750-960**  
 Connector PROFIBUS; DSub-M; 9P

**Technical Data**  
 Double cable entry point  
 Data transmission rate (max.)  
 Terminating resistor  
 Housing color  
 Protection type  
 Surrounding air temperature (operation)  
 Surrounding air temperature (storage)  
 Relative humidity  
 Conductor connection  
 Conductor cross sections  
**Approvals**  
 Data sheet and further information, see:

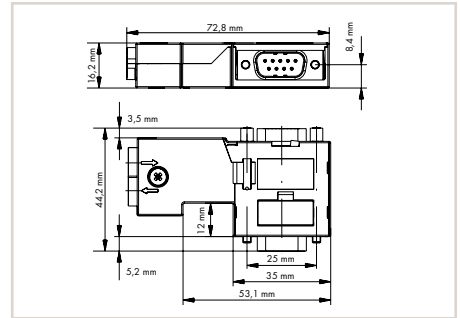
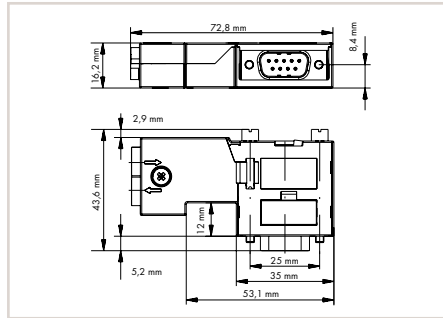
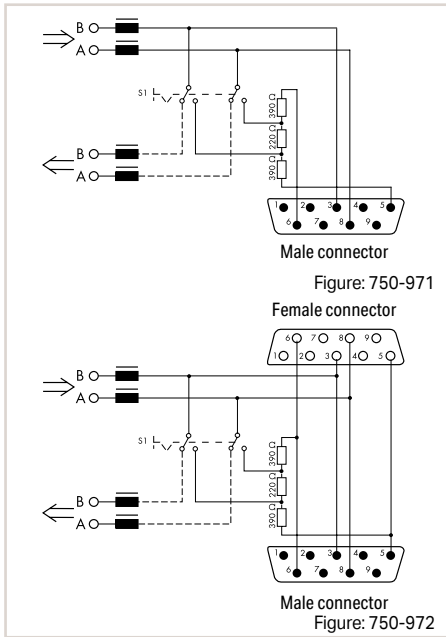
min. 4.5 mm Ø/ max. 9.5 mm Ø  
 12 Mbit/s  
 Integrated switch  
 Light gray  
 IP20  
 0 ... +60 °C  
 -25 ... +85 °C  
 95 %; non condensing  
 CAGE CLAMP® terminal strip with locking slides (218 Series)  
 0.08 ... 0.5 mm<sup>2</sup> / 28 ... 20 AWG; limited connection 0.75 mm<sup>2</sup> / 18 AWG possible  
 Marine; OrdLoc/HazLoc; ATEX/IECEx  
[wago.com/750-960](http://wago.com/750-960)

**Accessories**  
 Operating tool with a partially insulated shaft; Type 1; (2.5 x 0.4) mm blade  
 Operating tool with a partially insulated shaft; Type 2; (3.5 x 0.5) mm blade

Item No.	Page
210-719	504
210-720	504



# PROFIBUS Fieldbus Connector



<b>Item Description</b>
<b>Item No.</b>
<b>Order Text</b>

<b>PROFIBUS Fieldbus Connector; D-sub; 9-pole</b>
<b>750-971</b>
Connector PROFIBUS; DSub-M; 9P

<b>PROFIBUS Fieldbus Connector; with D-sub male and female connectors; 9-pole</b>
<b>750-972</b>
Connector PROFIBUS; DSub-M; 9P; PG-Int

<b>Technical Data</b>
Double cable entry point
Data transmission rate (max.)
Terminating resistor
Housing color
Protection type
Surrounding air temperature (operation)
Surrounding air temperature (storage)
Relative humidity
Conductor connection
Conductor cross sections
<b>Data sheet and further information, see:</b>

8.5 mm Ø
12 Mbit/s
Integrated switch
Light gray
IP20
-25 ... +70 °C
-25 ... +85 °C
95 %; non condensing
CAGE CLAMP® terminal strip with locking slides (218 Series)
0.08 ... 0.5 mm <sup>2</sup> / 28 ... 20 AWG; limited connection 0.75 mm <sup>2</sup> / 18 AWG possible
<a href="http://wago.com/750-971">wago.com/750-971</a>

8.5 mm Ø
12 Mbit/s
Integrated switch
Light gray
IP20
-25 ... +70 °C
-25 ... +85 °C
95 %; non condensing
CAGE CLAMP® terminal strip with locking slides (218 Series)
0.08 ... 0.5 mm <sup>2</sup> / 28 ... 20 AWG; limited connection 0.75 mm <sup>2</sup> / 18 AWG possible
<a href="http://wago.com/750-972">wago.com/750-972</a>

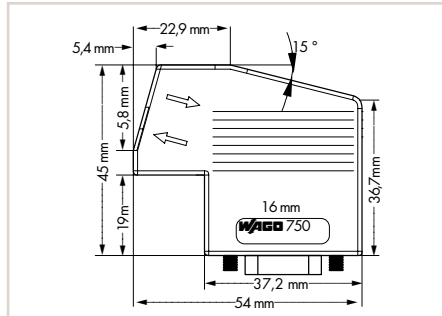
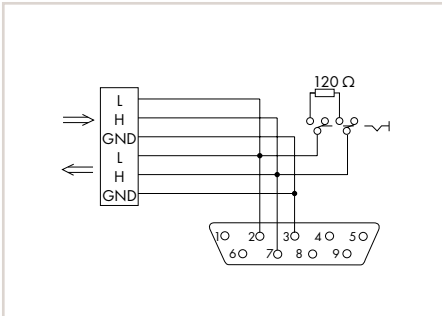
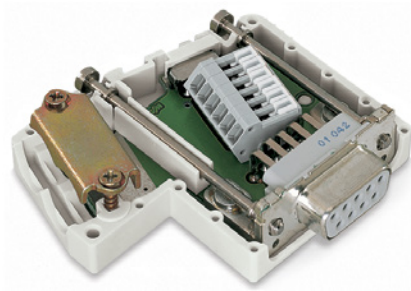
<b>Accessories</b>
Operating tool with a partially insulated shaft; Type 1; (2.5 x 0.4) mm blade

<b>Item No.</b>	<b>Page</b>
210-719	504

<b>Item No.</b>	<b>Page</b>
210-719	504

This fieldbus connector can be connected to a programming tool without interrupting the connection to the PROFIBUS device.

# CANopen Fieldbus Connector



<b>Item Description</b>	<b>CANopen Fieldbus Connector; with D-sub female connector; 9-pole</b>
<b>Item No.</b>	<b>750-963</b>
<b>Order Text</b>	Connector CANopen; DSub-F; 9P

Technical Data	
Double cable entry point	min. 4.5 mm Ø / max. 9.5 mm Ø
Data transmission rate (max.)	1 Mbd
Terminating resistor	Integrated switch
Housing color	Light gray
Protection type	IP20
Surrounding air temperature (operation)	0 ... +60 °C
Surrounding air temperature (storage)	-25 ... +85 °C
Relative humidity	95 %; non condensing
Conductor connection	CAGE CLAMP® terminal strip with locking slides (218 Series)
Conductor cross sections	0.08 ... 0.5 mm <sup>2</sup> / 28 ... 20 AWG; limited connection 0.75 mm <sup>2</sup> / 18 AWG possible
<b>Approvals</b>	☞ Marine; ☞ OrdLoc; ☞ ATEX/IECEX
<b>Data sheet and further information, see:</b>	<a href="http://wago.com/750-963">wago.com/750-963</a>

Accessories	
Operating tool with a partially insulated shaft; Type 1; (2.5 x 0.4) mm blade	<b>Item No.</b> 210-719 <b>Page</b> 504
Operating tool with a partially insulated shaft; Type 2; (3.5 x 0.5) mm blade	210-720 504

# INTERBUS Fieldbus Connector

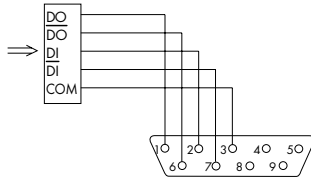


Figure: 750-961

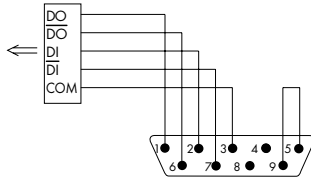
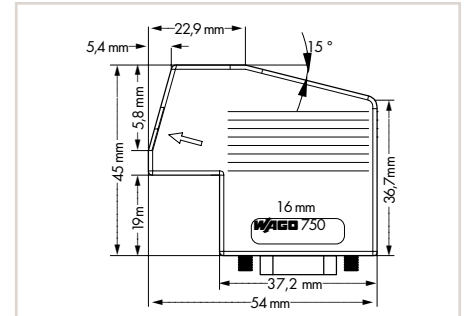
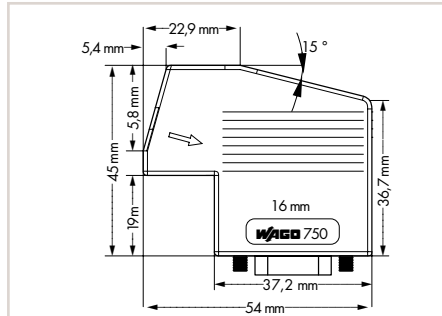
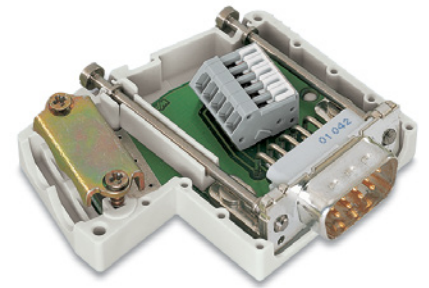
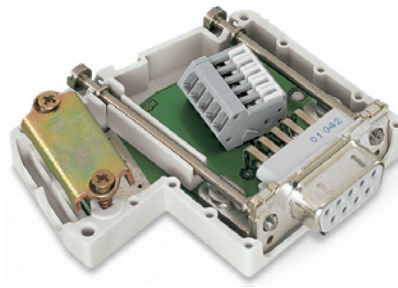


Figure: 750-962



<b>Item Description</b>
<b>Item No.</b>
<b>Order Text</b>

<b>INTERBUS Fieldbus Connector (IN); with D-sub female connector; 9-pole</b>
<b>750-961</b>
Connector INTERBUS; DSub-F; 9P

<b>INTERBUS Fieldbus Connector (OUT); with D-sub male connector; 9-pole</b>
<b>750-962</b>
Connector INTERBUS; DSub-M; 9P

<b>Technical Data</b>
Double cable entry point
Data transmission rate (max.)
Housing color
Protection type
Surrounding air temperature (operation)
Surrounding air temperature (storage)
Relative humidity
Conductor connection
Conductor cross sections
<b>Approvals</b>
<b>Data sheet and further information, see:</b>

min. 4.5 mm Ø/ max. 9.5 mm Ø
2 Mbd
Light gray
IP20
0 ... +60 °C
-25 ... +85 °C
95 %; non condensing
CAGE CLAMP® terminal strip with locking slides (218 Series)
0.08 ... 0.5 mm² / 28 ... 20 AWG; limited connection 0.75 mm² / 18 AWG possible
OrdLoc/HazLoc; ATEX/IECEx
<a href="http://wago.com/750-961">wago.com/750-961</a>

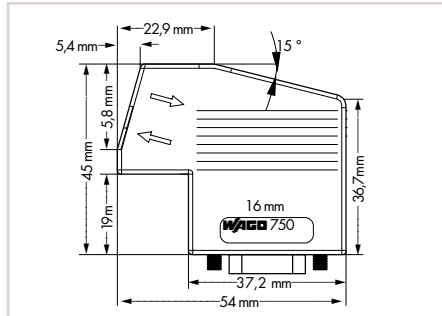
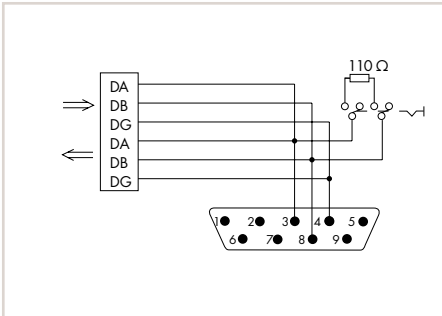
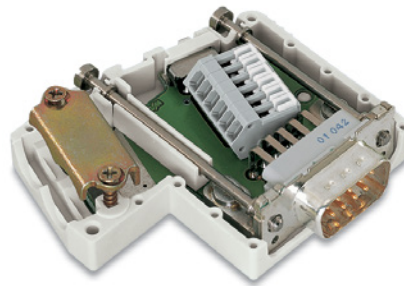
min. 4.5 mm Ø/ max. 9.5 mm Ø
2 Mbd
Light gray
IP20
0 ... +60 °C
-25 ... +85 °C
95 %; non condensing
CAGE CLAMP® terminal strip with locking slides (218 Series)
0.08 ... 0.5 mm² / 28 ... 20 AWG; limited connection 0.75 mm² / 18 AWG possible
OrdLoc/HazLoc; ATEX/IECEx
<a href="http://wago.com/750-962">wago.com/750-962</a>

<b>Accessories</b>
Operating tool with a partially insulated shaft; Type 1; (2.5 x 0.4) mm blade
Operating tool with a partially insulated shaft; Type 2; (3.5 x 0.5) mm blade

<b>Item No.</b>	<b>Page</b>
210-719	504
210-720	504

<b>Item No.</b>	<b>Page</b>
210-719	504
210-720	504

# CC-Link Fieldbus Connector



<b>Item Description</b>	<b>CC-Link Fieldbus Connector; with D-sub male connector; 9-pole</b>
<b>Item No.</b>	<b>750-965</b>
<b>Order Text</b>	Connector CC-Link; DSub-M; 9P

Technical Data	
Double cable entry point	min. 4.5 mm Ø / max. 9.5 mm Ø
Terminating resistor	Integrated switch
Housing color	Light gray
Protection type	IP20
Surrounding air temperature (operation)	0 ... +60 °C
Surrounding air temperature (storage)	-25 ... +85 °C
Relative humidity	95 %; non condensing
Conductor connection	CAGE CLAMP® terminal strip with locking slides (218 Series)
Conductor cross sections	0.08 ... 0.5 mm <sup>2</sup> / 28 ... 20 AWG; limited connection 0.75 mm <sup>2</sup> / 18 AWG possible
Approvals	® OrdLoc
Data sheet and further information, see:	<a href="http://wago.com/750-965">wago.com/750-965</a>

Accessories	
Operating tool with a partially insulated shaft; Type 1; (2.5 x 0.4) mm blade	<b>Item No.</b> 210-719 <b>Page</b> 504
Operating tool with a partially insulated shaft; Type 2; (3.5 x 0.5) mm blade	210-720 504

10

## System Enclosures

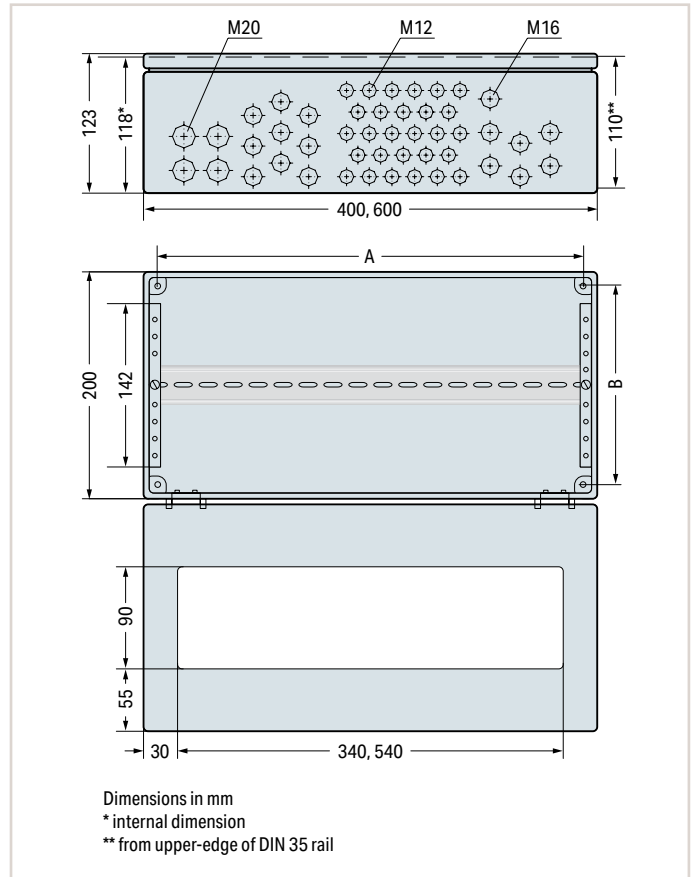


- ❶ Stainless steel
- ❷ Sheet steel
- ❸ Cast aluminum
- ❹ Polyester
- ❺ Sheet steel with cable entry plates

The increasing importance of the application of industrial fieldbus systems in various process engineering areas, such as the chemical and food industry, equally calls for enclosures to protect both the system technology used and the products to be produced.

For this reason, WAGO offers system enclosures that allow the use of the WAGO-I/O-SYSTEM 750/753 in systems exposed to severe environmental conditions. Each enclosure version is available in four different sizes and features the appropriate number of cable grips with metric thread or cable entry plates.

# Stainless-Steel System Enclosure



Item Description	IP65 System Enclosure; Stainless steel		
Version	WxHxD (400x123x200 mm); 4 x M20, 16 x M16, 28 x M12 cable grip	WxHxD (400x123x200 mm); 2 x M20, 13 x M16, 32 x M12 cable grip	WxHxD (600x123x200 mm); 4 x M20, 19 x M16, 67 x M12 cable grip
Item No.	850-804	850-804/000-001	850-805
Order Text	SST Enclosure; 14301 400mm CG5	SST Enclosure; 14301 400mm CG1	SST Enclosure; 14301 600mm CG6

Technical Data			
Number of M12 cable grips	28	32*	67
Number of M16 cable grips	16	13*	19
Number of M20 cable grips	4	2*	4
Recommended assembly dimension (A x B)	376 x 176 mm		576 x 176 mm
Dimensions W x H x D	400 x 123 x 200 mm		600 x 123 x 200 mm
Number of I/O modules	≤ 24**		≤ 40**
Data sheet and further information, see:	<a href="http://wago.com/850-804">wago.com/850-804</a>		<a href="http://wago.com/850-805">wago.com/850-805</a>

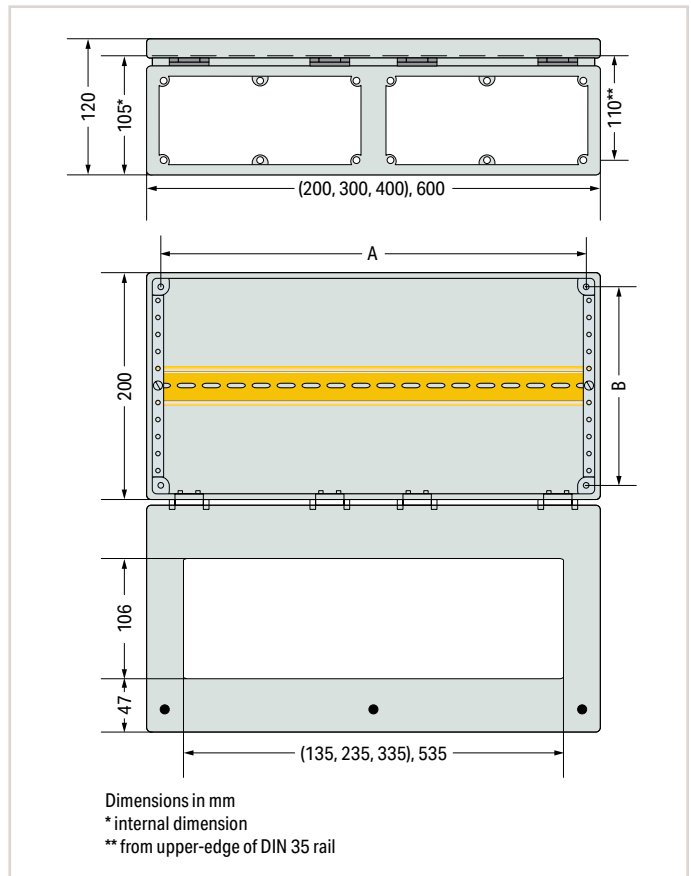
Accessories	Item No.
Pole mounting	850-903

\*Cable grip configuration differs from standard.  
 \*\*Both fieldbus coupler and end module are part of the system. This applies to 12 mm wide I/O modules. I/O modules with a width of 24 mm count as two I/O modules.

**Included:**

- Stainless steel enclosure 1.4301 streak finish
- Hinged cover 90°, (850-804/000-001: 180°), with cellular rubber gasket made of natural rubber, and 2-3 quick disconnects
- Hinges made of chromed GdZn (Gadulium Zinc) with M5 countersunk screws
- Macrolon inspection glass
- Metric cable glands (brass, nickel-plated), incl. blind plugs
- M12 fitting, cable diameter 5 ... 6 mm
- M16 fitting, cable diameter 5 ... 9 mm
- M20 fitting, cable diameter 9 ... 13 mm
- 1 x DIN 35/7.5 rail

# Sheet-Steel System Enclosure



Item Description	IP65 System Enclosure; Sheet steel (RAL 7035); without flange plate			
Version	WxHxD (200x120x200 mm)	WxHxD (300x120x200 mm)	WxHxD (400x120x200 mm)	WxHxD (600x120x200 mm)
Item No.	850-814/002-000	850-815/002-000	850-816/002-000	850-817/002-000
Order Text	STE Enclosure; RAL7035 200mm	STE Enclosure; RAL7035 300mm	STE Enclosure; RAL7035 400mm	STE Enclosure; RAL7035 600mm

Technical Data	160 x 160	260 x 160	360 x 160	560 x 160
Recommended assembly dimension (A x B)	160 x 160	260 x 160	360 x 160	560 x 160
Dimensions W x H x D	200 x 120 x 200 mm	300 x 120 x 200 mm	400 x 120 x 200 mm	600 x 120 x 200 mm
Number of I/O modules	≤ 8*	≤ 16*	≤ 24*	≤ 40*
Data sheet and further information, see:	<a href="http://wago.com/850-814/002-000">wago.com/ 850-814/002-000</a>	<a href="http://wago.com/850-815/002-000">wago.com/ 850-815/002-000</a>	<a href="http://wago.com/850-816/002-000">wago.com/ 850-816/002-000</a>	<a href="http://wago.com/850-817/002-000">wago.com/ 850-817/002-000</a>

Accessories: Flange Plates	Number of flange plates that can be fitted			
Size 195 x 95 mm: F200; F200-1; F200-2; F204	1	-	2	-
Size 295 x 95 mm: F300; F300-1; F300-2; F304	-	1	-	2

Accessories	Item No.
Wall mount	850-904

\*Both fieldbus coupler and end module are part of the system. This applies to 12 mm wide I/O modules. I/O modules with a width of 24 mm count as two I/O modules.

Included:

- Powder-coated, sheet steel enclosure
- Box with narrow beveled edge, sturdy gutter profile
- Hinged cover 180° (PA), with foam PU seal and 2–3 quick disconnects
- Quick-release fasteners in plastic bushes
- Mounting holes (incl. sealing plugs)
- Large Macrolon inspection glass
- Removable, yellow-chromized interior profiles
- Galvanized DIN-35/7.5 rail (contact with enclosure), adjustable in 12.5 mm spacing
- Grounding lug for cover and flanges with quick-release ribbon cable connectors
- Light gray (RAL 7035)

10



## Flange Plate and Cable Entry Plate

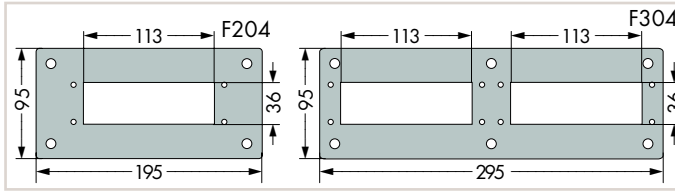
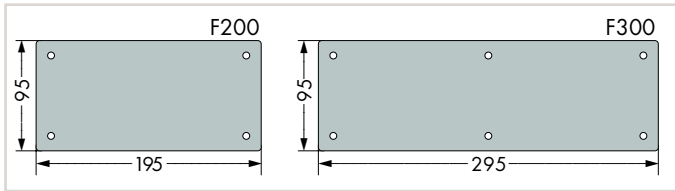
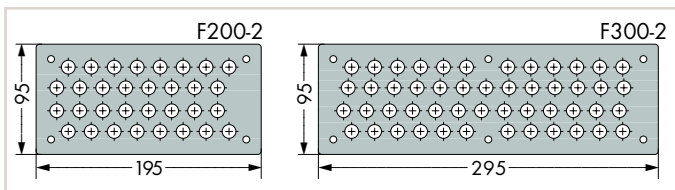
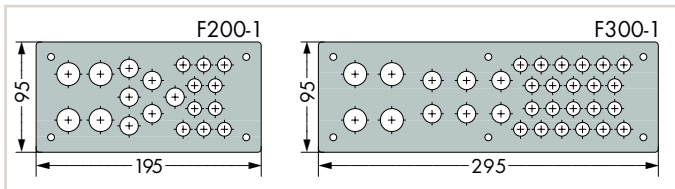


Illustration: Flange Plate F204 with Cable Entry Plate KDP 22



Similar to illustration

Flange Plate; RAL7035; without cut-out		
	Width x Height	Item No.
F200 Flange Plate RAL7035 WCO	195 x 95 mm	850-818/002-000
F300 Flange Plate RAL7035 WCO	295 x 95 mm	850-819/002-000

Flange Plate; RAL7035; with cut-out		
	Width x Height	Item No.
F204 Flange Plate RAL7035 1CO	195 x 95 mm	850-818/002-005
F304 Flange Plate RAL7035 2CO	295 x 95 mm	850-819/002-005

Cable Entry Plate		Item No.
KDP 22 Cable Entry Plate; 16 x Size 1, 4 x Size 2, 2 x Size 3		850-820/000-001
KDP 29 Cable Entry Plate; 29 x Size 1		850-820/000-002

Cable entry plate, polyamide  
 Size 1: Cable diameter 3.0 ... 6.5 mm  
 Size 2: Cable diameter 5.0 ... 9.2 mm  
 Size 3: Cable diameter 8.0 ... 12.5 mm

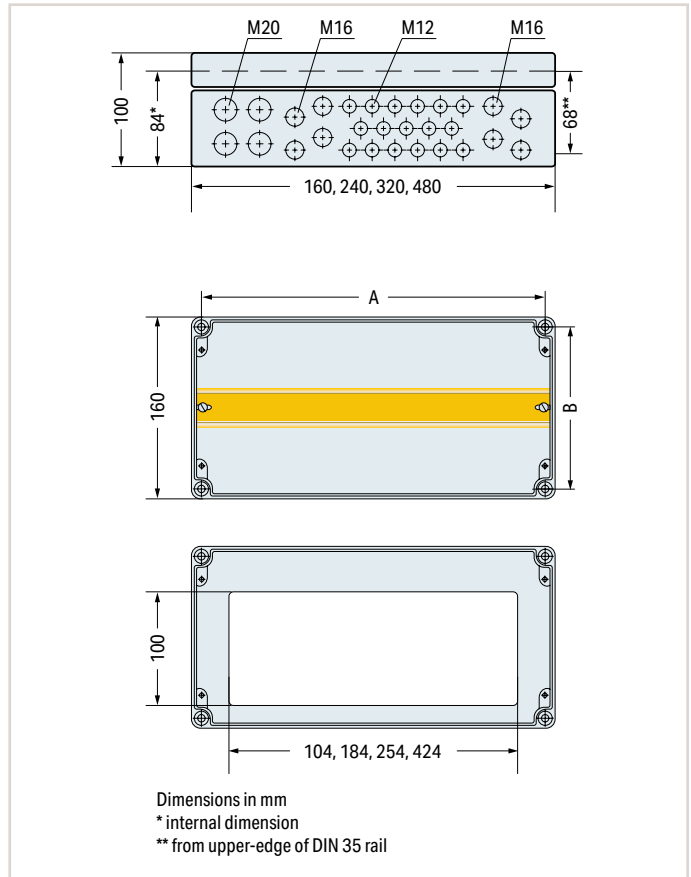
Flange Plate; RAL7035; M20, M16, M12 bore holes		
	Width x Height	Item No.
F200-1 Flange Plate RAL7035 HO1; 4 x M20, 6 x M16, 10 x M12	195 x 95 mm	850-818/002-001
F300-1 Flange Plate RAL7035 HO5; 4 x M20, 6 x M16, 22 x M12	295 x 95 mm	850-819/002-001

Flange Plate; RAL7035; M20, M16, M12 cable grips		
	Width x Height	Item No.
F200-1 Flange Plate RAL7035 CG8; 4 x M20, 6 x M16, 10 x M12	195 x 95 mm	850-818/002-002
F300-1 Flange Plate RAL7035 CG9; 4 x M20, 6 x M16, 22 x M12	295 x 95 mm	850-819/002-002

Flange Plate; RAL7035; M12 bore holes		
	Width x Height	Item No.
F200-2 Flange Plate RAL7035 HO4; 32 x M12	195 x 95 mm	850-818/002-003
F300-2 Flange Plate RAL7035 HO6; 50 x M12	295 x 95 mm	850-819/002-003

Flange Plate; RAL7035; M12 cable grips		
	Width x Height	Item No.
F200-2 Flange Plate RAL7035 HO2; 32 x M12	195 x 95 mm	850-818/002-004
F300-2 Flange Plate RAL7035 CG12; 50 x M12	295 x 95 mm	850-819/002-004

# Aluminum System Enclosure



Item Description	IP65 System Enclosure; Aluminum			
Version	Enclosure type in RAL 7032			
Item No.	850-825	850-826	850-827	850-828
Order Text	ALU Enclosure; RAL7032 160mm CG11	ALU Enclosure; RAL7032 240mm CG7	ALU Enclosure; RAL7032 320mm CG10	ALU Enclosure; RAL7032 480mm CG4
Version	Enclosure type in RAL 7035			
Item No.		850-826/002-000	850-827/002-000	850-828/002-000
Order Text		ALU Enclosure; RAL7035 240mm CG7	ALU Enclosure; RAL7035 320mm CG10	ALU Enclosure; RAL7035 480mm CG4
<b>Technical Data</b>				
Number of M12 cable grips	9	14	17	35
Number of M16 cable grips	-	4	8	10
Number of M20 cable grips	4			
Recommended assembly dimension (A x B)	142 x 142 mm	222 x 142 mm	302 x 142 mm	462 x 142 mm
Dimensions W x H x D	160 x 100 x 160 mm	240 x 100 x 160 mm	320 x 100 x 160 mm	480 x 100 x 160 mm
Number of I/O modules	≤ 4*	≤ 11*	≤ 18*	≤ 31*
Data sheet and further information, see:	wago.com/850-825	wago.com/850-826	wago.com/850-827	wago.com/850-828
<b>Accessories</b>	<b>Item No.</b>			
Pole mounting	850-903			

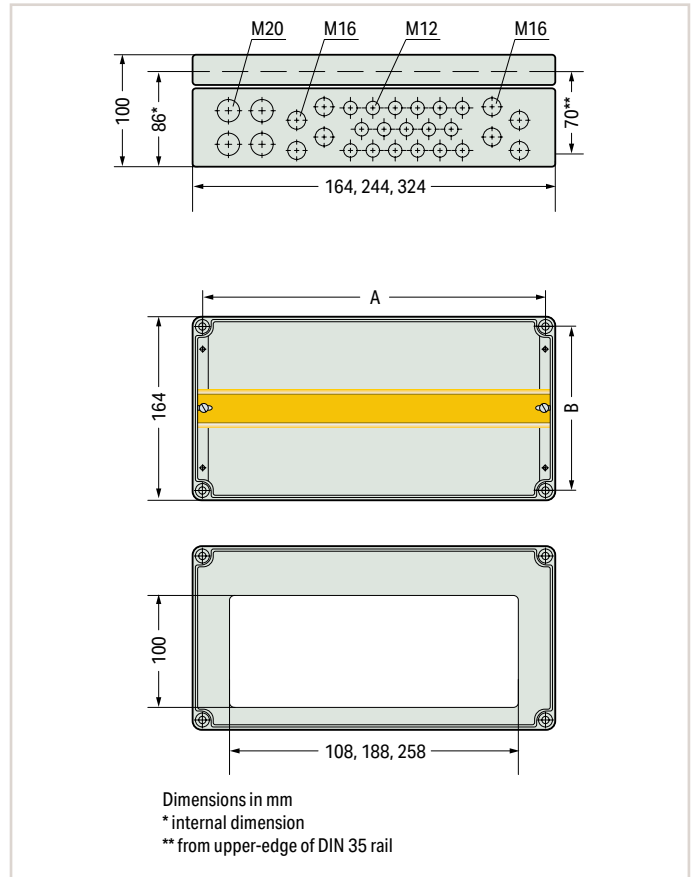
\*Both fieldbus coupler and end module are part of the system. This applies to 12 mm wide I/O modules. I/O modules with a width of 24 mm count as two I/O modules.

**Included:**

- Aluminum enclosure, G AL Si 12 alloy / DIN 1725
- Stainless steel cover screws, captive
- Inspection glass, incl. attachment panel for customer marking (marking not included in scope of supply)
- Mounting holes (4 mounting channels located outside the sealed enclosure)
- Metric cable glands (brass, nickel-plated), incl. blind plugs
- M12 fitting, cable diameter 5 ... 6 mm
- M16 fitting, cable diameter 5 ... 9 mm
- M20 fitting, cable diameter 9 ... 13 mm
- 1x DIN-35/7.5 rail
- Tongue and groove system, seal with groove in enclosure cover
- Oil and petroleum-resistant neoprene round chord seal
- Grounding link in enclosure
- Pebble gray RAL 7032 or light gray RAL 7035

10

# Polyester System Enclosure



Item Description	IP65 System Enclosure; Polyester (RAL 7032)		
Version	WxHxD (164x100x164 mm); 9 x M12, 4 x M20	WxHxD (244x100x164 mm); 4 x M20, 4 x M16, 14 x M12 cable grip	WxHxD (324x100x164 mm); 4 x M20, 8 x M16, 17 x M12 cable grip
Item No.	850-834	850-835	850-836
Order Text	POL Enclosure; RAL7032 164mm CG11	POL Enclosure; RAL7032 244mm CG7	POL Enclosure; RAL7032 324mm CG10

Technical Data			
Number of M12 cable grips	9	14	17
Number of M16 cable grips	-	4	8
Number of M20 cable grips	4		
Recommended assembly dimension (A x B)	142 x 142 mm	222 x 142 mm	302 x 142 mm
Dimensions W x H x D	164 x 100 x 164 mm	244 x 100 x 164 mm	324 x 100 x 164 mm
Number of I/O modules	≤ 4*	≤ 11*	≤ 18*
Data sheet and further information, see:	<a href="http://wago.com/850-834">wago.com/850-834</a>	<a href="http://wago.com/850-835">wago.com/850-835</a>	<a href="http://wago.com/850-836">wago.com/850-836</a>

Accessories	Item No.
Pole mounting	850-903

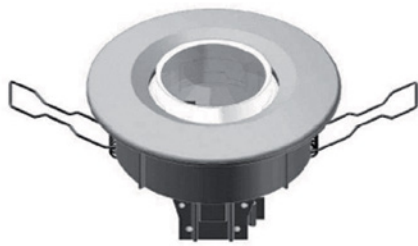
\*Both fieldbus coupler and end module are part of the system. This applies to 12 mm wide I/O modules. I/O modules with a width of 24 mm count as two I/O modules.

Included:

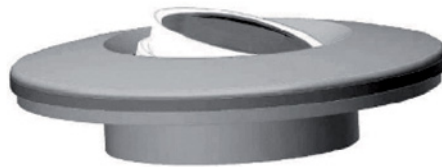
- Polyester enclosure, glass-fiber-reinforced, halogen-free, as V0 version (self-extinguishing)
- Polyamide cover screws, captive
- Inspection glass, incl. attachment panel for customer marking (marking not included in scope of supply)
- Mounting holes (4 mounting channels located outside the sealed enclosure)
- Metric cable grips (polyamide PA 6), incl. blind plugs
- M12 fitting, cable diameter 5 ... 6 mm
- M16 fitting, cable diameter 5 ... 9 mm
- M20 fitting, cable diameter 9 ... 13 mm
- 1x DIN-35/7.5 rail
- Oil and petroleum-resistant neoprene round chord seal
- Pebble gray, RAL 7032

# DALI Multi-Sensor

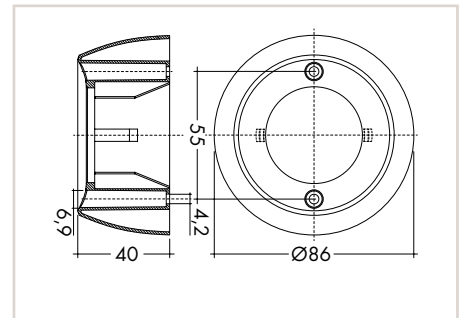
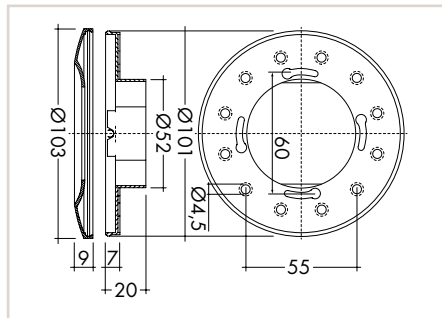
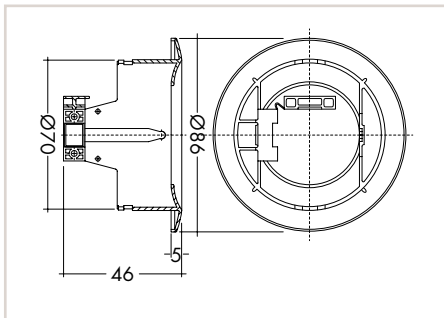
## Ceiling Installation



## Box Installation



## Surface Mount



The WAGO DALI MSensor 02 is paired with DALI Master I/O modules (753-647 or 750-641) and has been designed for the following key applications:

- Individual offices
- Open-plan offices
- Training/Presentation rooms
- Corridors, passageways and garages

This multi-sensor features both a motion/presence detector and a light sensor. As an option, the sensor can be operated via remote control (from Tridonic). The sensor enables both motion/presence detection and daylight-dependent lighting control, both of which can also be deactivated.

Addressing is performed via rotary switch or WAGO DALI Configurator. Parameters can be adjusted individually via WAGO DALI Configurator. Power supply is provided via the DALI line.

The number of sensors, which can be operated on a DALI line, depends on the total power consumption of the specific devices and the address range for the actuators and sensors. Due to the capacity of the DALI bus, a maximum of 16 DALI sensor couplers may be operated on a DALI Multi-Master Module (753-647).

### Installation notes:

- The DALI MSensor 02 is supplied directly via DALI line.
- DALI is not SELV (Safety Extra Low Voltage). The installation instructions for mains voltage therefore apply.
- The detection range of the sensor must be within the lighting area of the controlled luminaires.
- The detection ranges of the sensors must not overlap as this may influence the lighting control.
- When installed at a height other than the recommended installation height (2.5 m), the presence and light sensor might show different characteristics. If installed at a higher height, the sensitivity is reduced; the range is reduced when installed at a lower height.
- Heaters, fans, printers and copiers located in the detection range may cause incorrect presence detection.

Item Description	DALI MSensor 02 5DPI 41rc (ceiling installation)	DALI MSensor 02 5DPI 41w (box installation)	DALI MSensor 02 5DPI 41rs (surface mount)
Item No.	2851-8301	2851-8302	2851-8303
<b>Technical Data</b>			
Diameter of detection range when installed at a height of 2.5 m	5 m		
Extension of the detection range	2 m (if mounted at a height of 2.5 m and swiveled through 15°)	-	
Swivel design	Yes	No	
Swivel range	± 15°	-	
Detection angle	360°		
Light measurement at the sensor head	10 ... 650 lx (The measured value at the sensor head corresponds to approx. 15 to 2,000 lux on the surface measured.)		
Remote control range	5 m		
Data sheet and further information, see:	<a href="http://wago.com/2851-8301">wago.com/2851-8301</a>	<a href="http://wago.com/2851-8302">wago.com/2851-8302</a>	<a href="http://wago.com/2851-8303">wago.com/2851-8303</a>

10

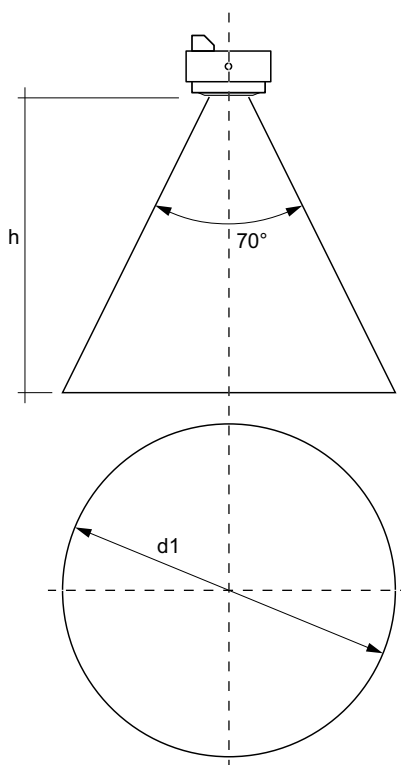
**Technical Data**

Power supply	via DALI line
Current consumption	6 mA from DALI line
Surrounding air temperature (operation)	0 ... +50 °C
Surrounding air temperature (storage)	-25 ... +55 °C
Protection type	IP20
Wire type and cross section	Solid or fine-stranded wires ranging from 0.5 to 1.5 mm <sup>2</sup> (20 ... 16 AWG)

**Technical Data**

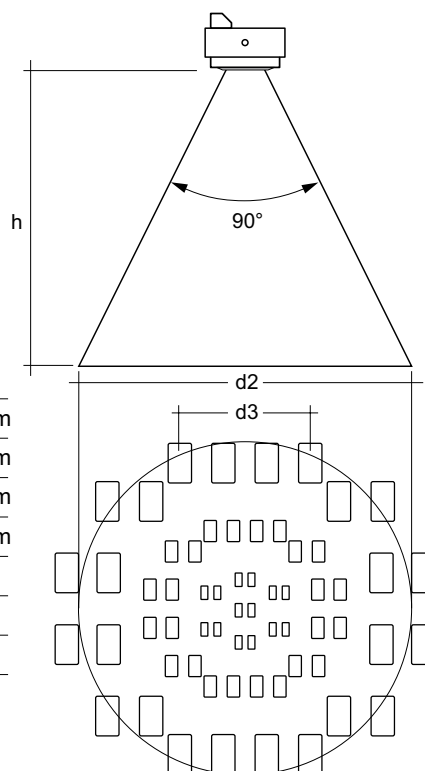
<b>General Settings</b>	
Motion detector	Switching, on/off
Lighting control	Switching
Setpoint (lighting control)	150 lx
Power-on setting	No action
Bright-out timeout	10 min
Bright-out threshold	150 %
Control speed	4
Switch-on value	Automatic (calculated)
Rotary switch	0, broadcast
<b>Motion Detector Settings</b>	
Fade-in time	< 0.7 s
Presence value	Regulated
Run-on time	20 min
Fade time	5.6 s
Absence value	3 %
Switch-off delay	10 min
Fade-off time	5.6 s
Manual-off	10 min

**Light Detection**



$h^*$	$d_1$	$d_2$	$d_3$
1,7m	2,4m	3,4m	1,36m
2,0m	2,8m	4,0m	1,60m
2,3m	3,2m	4,6m	1,84m
2,5m	3,5m	5,0m	2,00m
2,7m	3,8m	5,4m	-
3,0m	4,2m	6,0m	-
3,5m	4,9m	7,0m	-
4,0m	5,6m	8,0m	-

**Motion Detection (d2) and Presence Detection (d3)**

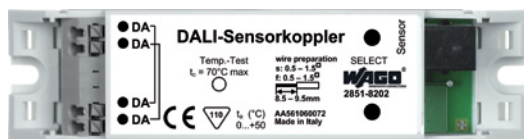


\*The recommended maximum room height for office applications is 3 m and for corridor applications 4 m, for example.

Calculation of the diameter:  
 $d = 2 \times \tan(0.5 \times \alpha) \times h$

## WAGO DALI Multi-Sensor Kit

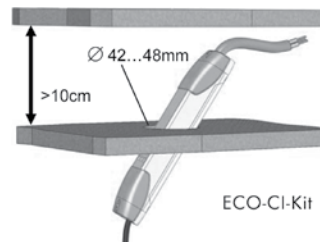
### DALI Sensor Coupler



### MULTI 3 CI Sensor



### Eco CI Kit



The WAGO DALI Multi-Sensor Kit is paired with the WAGO 753-647 DALI Multi-Master Module and includes the following three components:

- DALI Sensor Coupler (also available individually)
- Eco CI Kit
- MULTI 3 CI Sensor

The DALI Sensor Coupler connects the MULTI 3 CI Sensor to a DALI bus system. For this, the MULTI 3 CI Sensor is connected to the DALI Sensor Coupler via RJ-10 socket. DALI terminals connect the DALI Sensor Coupler to both the DALI network and WAGO DALI Module.

The Eco CI Kit contains two covers, which can be used as touch guards and strain relief for cables within the ceiling installation of the DALI Sensor Coupler. The MULTI 3 CI Sensor has a motion and light sensor, enabling both motion detection and daylight-dependent lighting control. Power supply to the DALI Sensor Coupler is provided via DALI line. The DALI Sensor Coupler transmits measured values from the connected sensor channels as telegrams to the WAGO DALI Module via DALI line. Parameters can be adjusted individually via WAGO DALI Configurator.

The number of sensors, which can be operated on a DALI line, depends on the total power consumption of the specific devices and the address range for the actuators and sensors. Due to the capacity of the DALI bus, a maximum of 16 DALI Sensor Couplers may be operated on a DALI Multi-Master Module (753-647).

#### Assembly

#### Sensor Connection

The MULTI 3 CI Sensor is connected to a 4-pole RJ-10 socket (4P4C), which is marked as "Sensor" on the housing cover.

For easy connection, the sensor plug is equipped with a quick-connect latch. Only one MULTI 3 CI Sensor must be connected to sensor coupler.

#### Ceiling Installation

For installation outside of a lighting fixture (e.g., suspended ceiling), the Eco CI Kit must also be attached to both sides of the unit to ensure strain relief and touch protection. The DALI Sensor Coupler can also be installed in lighting fixtures. The installation spaces available in lighting fixtures can be used, as the dimensions correspond to those of an electronic ballast.

#### Note:

The DALI Sensor Coupler is also available individually, allowing the unit to be combined with other multi-sensor models from OSRAM.

#### WAGO DALI Multi-Sensor Kit

Delivery type	Item No.
Set includes:	
DALI Sensor Coupler, MULTI 3 CI Sensor, Eco CI Kit	2851-8201
DALI Sensor Coupler	2851-8202

#### DALI Sensor Coupler

Power supply	via DALI line
Current consumption	5 mA (from the DALI line)
Input signal voltage/current	according to MULTI 3 CI Sensor
Conductor connection	Inputs: for MULTI 3 CI Sensor's modular plug 4p4c (RJ-10); Sensor cable length ( max.): 5 m; DALI connection: Push-wire connectors; Strip length: 8.5 ... 9.5 mm
Conductor cross sections	0.5 ... 1.5 mm <sup>2</sup> (s + f-st)
Dimensions W x H x D	118 x 21 x 30 mm
Weight	35 g
Surrounding air temperature (operation)	0 ... +50 °C
Surrounding air temperature (storage)	-25 ... +70 °C
Relative humidity	5 ... 93 %; non-condensing
Protection type	IP20
Approvals	CE

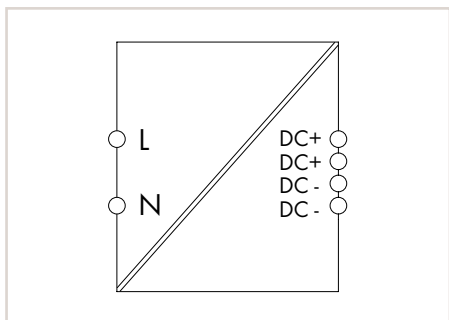
#### Eco CI Kit

Installation opening diameter	42 ... 48 mm
Minimum suspended ceiling distance	25 mm

#### MULTI 3 CI Sensor

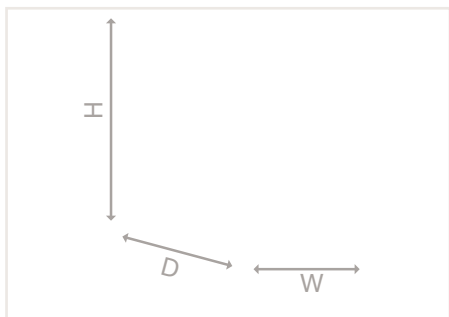
Maximum total length of signal line (incl. all connections to the control units)	100 m
Dimensions (diameter x H)	50 x 25 mm
Light sensor detection range	20 ... 600 lx (measured at sensor), beam angle approx. 90°
Recommended installation height	2 ... 4 m
Motion detection range	Cone-shaped, beam angle approx. 80°, depending on installation level 4 ... 8 m

## Switched-Mode Power Supply; for DALI Module; Compact; 1-Phase 787 Series



Switched-Mode Power Supply; for DALI Module (753-647); 1-phase; Output voltage: 18 VDC; Output current: 1.1 A

Item No.	Pack. Unit
787-1007	1



### Short description:

The 787-1007 Switched-Mode Power Supply is specially designed to supply the 753-647 DALI Multi-Master Module. The 787-1007 features a 54 mm wide DIN-rail-mount enclosure with input voltage range of 85 to 264 VAC (120 ... 373 VAC). The power supply provides an output voltage of 18 VDC and a maximum output current of 1100 mA. This allows several DALI Multi-Master Modules to be supplied in parallel. The maximum current per DALI line is limited to 200 mA in each DALI Multi-Master Module.

### Features:

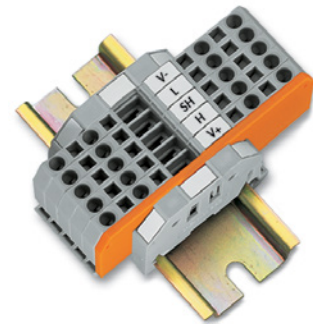
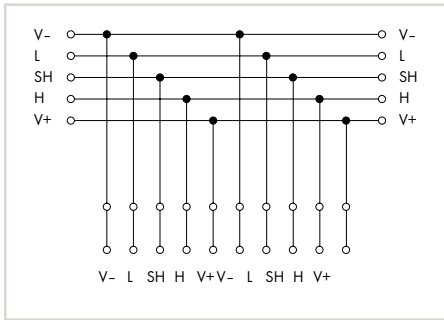
- Supplies up to five 753-647 DALI Multi-Master Modules\*
- Suitable for protection class II equipment
- Natural convection cooling when horizontally mounted
- Stepped profile, ideal for distribution boards/boxes

### \*Note:

The 787-1007 Power Supply must be operated in a DALI network with interconnected 753-647 DALI Multi-Master Module. Otherwise the connected DALI devices will be destroyed.

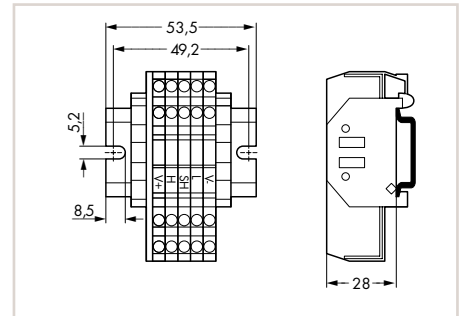
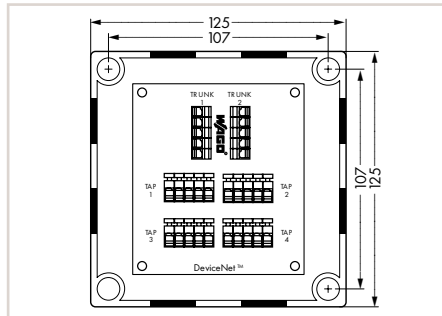
<b>Input</b>	
Phases	1
Nominal input voltage $U_i \text{ nom}$	100 ... 240 VAC
Input Voltage Range	85 ... 264 VAC; 120 ... 373 VDC
Nominal mains frequency range	44 ... 66 Hz; 0 Hz
Input current $I_i$	$\leq 0.4 \text{ A}$ (230 VAC); $\leq 0.6 \text{ A}$ (110 VAC)
Inrush current	$\leq 30 \text{ A}$ (NTC)
Mains failure hold-up time	$\geq 80 \text{ ms}$ (230 VAC); $> 10 \text{ ms}$ (110 VAC)
<b>Output</b>	
Nominal output voltage $V_o \text{ nom}$	18 VDC
Default setting	18 VDC
Nominal output current $I_o \text{ nom}$	1.1 A (18 VDC); max. 0.8 A (18 VDC) in any mounting position
Adjustment accuracy	$\leq 2 \%$
Residual ripple	$\leq 100 \text{ mV}$ (peak-to-peak)
Current limitation	1.1 x $I_o \text{ nom}$ (typ.)
Overload behavior	Constant current
<b>Signaling and Communication</b>	
Status indication	Green LED ( $U_o$ )
<b>Efficiency/Power Losses</b>	
Power loss PI	$\leq 3 \text{ W}$ (230 VAC; no load); $\leq 6 \text{ W}$ (230 VAC; nominal load)
Efficiency	$\geq 80 \%$
<b>Fuse Protection</b>	
Internal fuse	2 AT
Required backup fusing	An external DC fuse is required for the DC input voltage.
Recommended backup fusing	Circuit breaker 10 A (C characteristic), 16 A (B characteristic) or higher
<b>Safety and Protection</b>	
Isolation voltage (pri.-sec.)	4.242 kVDC
Protection class	II
Protection type	IP20 (per EN 60529)
Feedback voltage	$\leq 20 \text{ VDC}$
Short-circuit-protected	Yes
Open-circuit-proof	Yes
MTBF	$> 500,000 \text{ h}$ (per IEC 61709)
<b>Connection Data</b>	
Connection type	Input/output
Connection technology	CAGE CLAMP®
WAGO Connector	WAGO 740 Series
Solid conductor	0.08 ... 2.5 mm <sup>2</sup> / 28 ... 12 AWG
Fine-stranded conductor	0.08 ... 2.5 mm <sup>2</sup> / 28 ... 12 AWG
Strip length	6 ... 7 mm / 0.24 ... 0.28 inch
<b>Geometric Data</b>	
Width	54 mm / 2.126 inch
Height	89 mm / 3.504 inch
Depth	59 mm / 2.323 inch
Depth from upper-edge of DIN-rail	55 mm / 2.165 inch
<b>Mechanical Data</b>	
Mounting type	DIN-35 rail (EN 60715)
<b>Material Data</b>	
Weight	170 g
<b>Environmental Requirements</b>	
Surrounding air temperature (operation)	-25 ... +60 °C
Surrounding air temperature (storage)	-25 ... +80 °C
Relative humidity	5 ... 96 % (no condensation permissible)
Pollution degree	2
Climatic category	3K3 (per EN 60721)
<b>Standards and Specifications</b>	
Standards/specifications	EN 60950-1; EN 61204-3; UL 508; DNV GL

## Multi Port Device Tap for DeviceNet



For DeviceNet, a terminating resistor must be connected to each end of the trunk cable. A metal film resistor with the following values must be used: 121 Ohm ± 1 %, ¼ W.

Do not connect terminating resistors to the end of a drop cable, but only to the ends of the trunk cable.



Item Description	Multi Port Device Tap; 2 trunk cables (input, output); 4 drop cables; IP65/NEMA 4 housing	Multi Port Device Tap; 2 trunk cables (input, output); 2 drop cables; Open style
Item No.	810-900/000-001	810-901/000-001

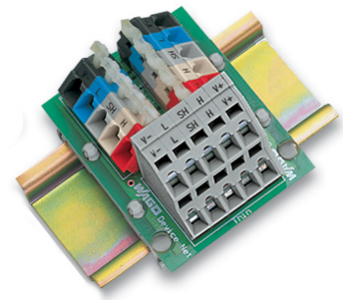
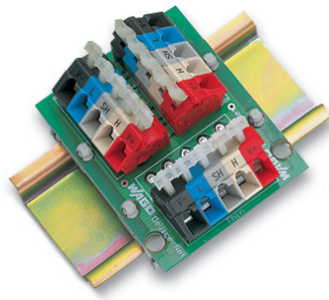
Technical Data		
Wire connection for trunk cables	2 x 256-405 (PCB terminal blocks)	
Wire connection for drop cables	4 x 255-405 (PCB terminal blocks)	
Housing	with cable entry holes	
Terminal block		5 x 280-633
End terminal block		2 x 249-116
DIN-rail		DIN 35, slotted
Conductor cross sections	0.08 ... 2.5 mm <sup>2</sup> / 28 ... 12 AWG	0.08 ... 2.5 mm <sup>2</sup> / 28 ... 12 AWG
Cable diameter (trunk cable)	10 ... 14 mm Ø	
Cable diameter (drop cable)	6 ... 12 mm Ø	
Degree of protection	IP65/NEMA 4	
Data sheet and further information, see:	<a href="http://wago.com/810-900/000-001">wago.com/810-900/000-001</a>	<a href="http://wago.com/810-901/000-001">wago.com/810-901/000-001</a>

Accessories	Item No.	Pack. Unit	Item No.	Pack. Unit
Cable grip for trunk cable 10 ... 14 mm Ø	810-900/001-000	1		
Cable grip for drop cable 6 ... 12 mm Ø	810-900/002-000	1		
Terminating resistor	810-900/003-000	200	810-900/003-000	200
Test adapter for miniature banana plug	810-900/004-000	1	810-901/001-000	1

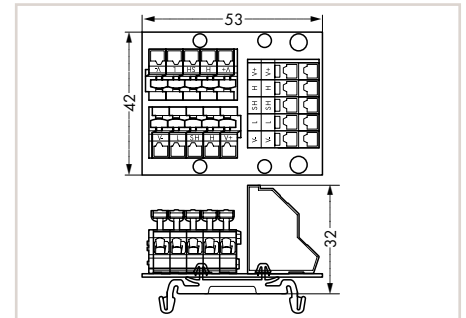
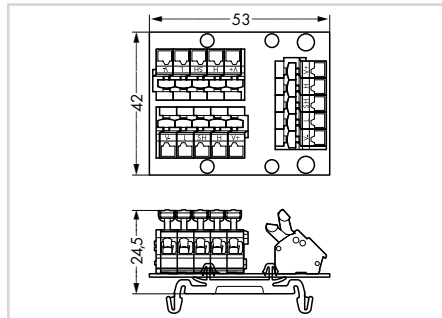
\*when using the cable grip  
(available as accessories)



## Multi Port Device Tap for DeviceNet

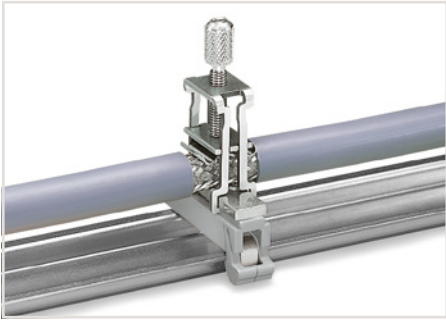


For DeviceNet, a terminating resistor must be connected to each end of the trunk cable. A metal film resistor with the following values must be used: 121 Ohm ± 1 %, ¼ W.  
Do not connect terminating resistors to the end of a drop cable, but only to the ends of the trunk cable.



Item Description	Multi Port Device Taps with Mounting Foot; 2 trunk cables (input, output); 1 drop cable; Open style		Multi Port Device Taps with Mounting Foot; 2 trunk cables (input, output); 2 drop cables; Open style	
Item No.	810-902/000-001		810-902/000-002	
<b>Technical Data</b>				
Wire connection for trunk cables	2 x 5 x 256 Series (PCB terminal blocks)		2 x 5 x 256 Series (PCB terminal blocks)	
Wire connection for drop cables	1 x 5 x 256 Series (PCB terminal blocks)		1 x 5 x 736 Series (PCB terminal blocks)	
Conductor cross sections	0.08 ... 2.5 mm <sup>2</sup> / 28 ... 12 AWG		0.08 ... 2.5 mm <sup>2</sup> / 28 ... 12 AWG	
Data sheet and further information, see:	<a href="http://wago.com/810-902/000-001">wago.com/810-902/000-001</a>		<a href="http://wago.com/810-902/000-002">wago.com/810-902/000-002</a>	
<b>Accessories</b>				
Terminating resistor	Item No.	Pack. Unit	Item No.	Pack. Unit
Test adapter for miniature banana plug	810-900/003-000	200	810-900/003-000	200
	810-901/001-000	1	810-901/001-000	1

## Shield Connection System, 790 Series Application and Installation Instructions



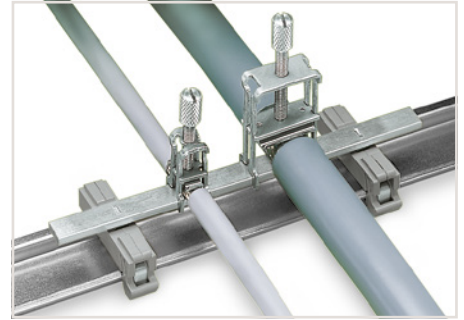
Carrier with grounding foot\* (790-113),  
45 mm long, busbar 90° to the rail

\*for all shield clamping saddle sizes



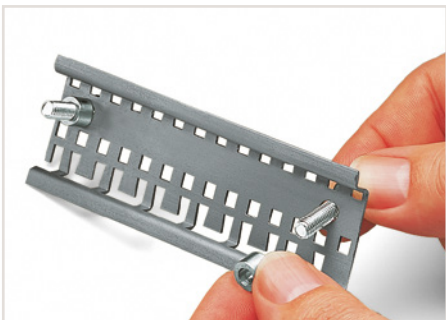
Carrier with grounding foot\* (790-114),  
45 mm long, busbar parallel to the rail

\*for all shield clamping saddle sizes



Carrier with grounding foot\* (790-115),  
125 mm long, busbar parallel to the rail

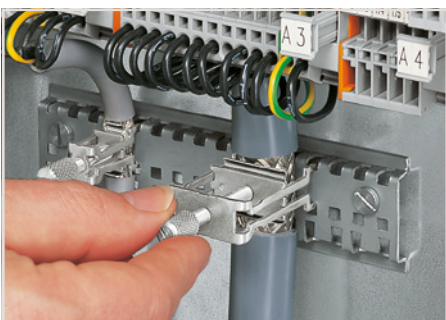
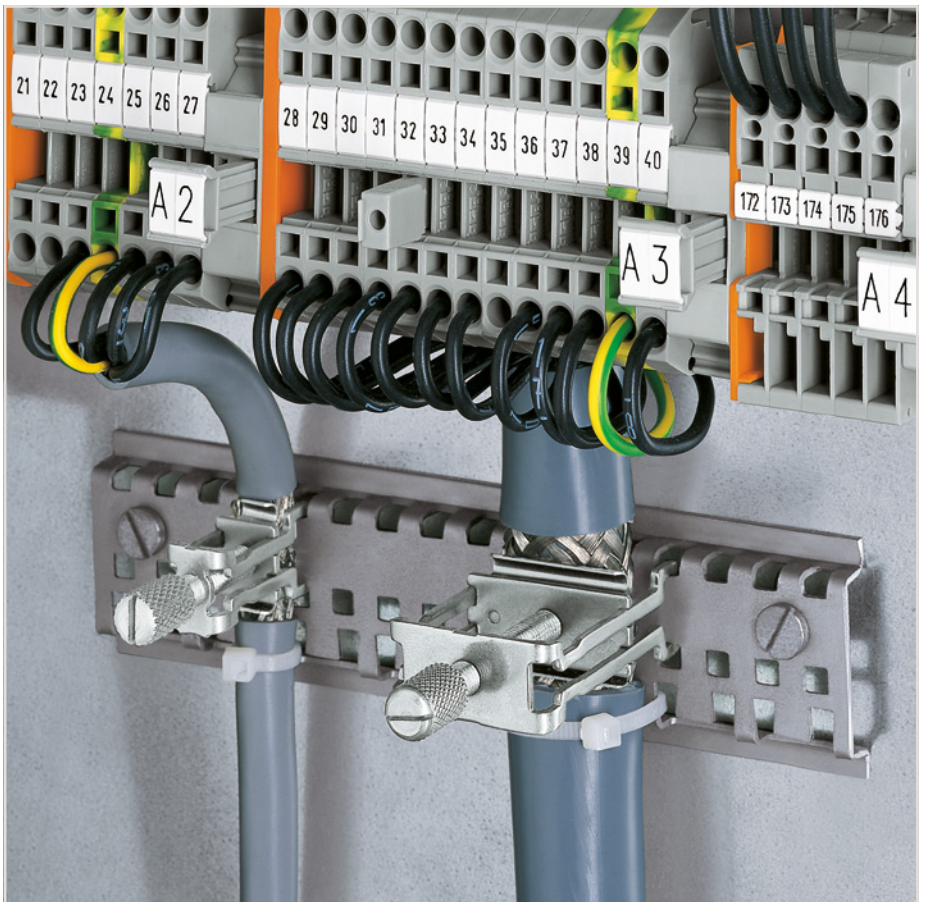
\*for all shield clamping saddle sizes



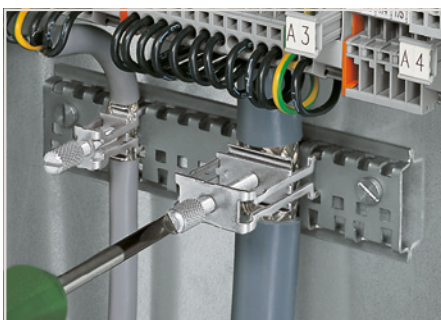
Securing a spacer sleeve to a specialty slotted  
DIN-rail.



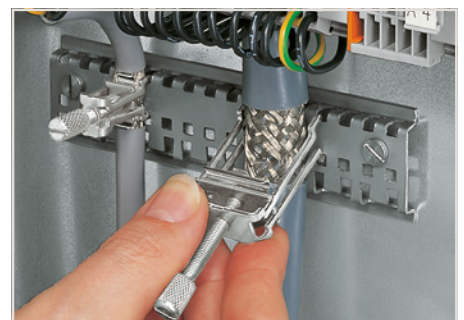
Securing an additional shield clamping saddle.



Tightening/removing a shield clamping saddle.



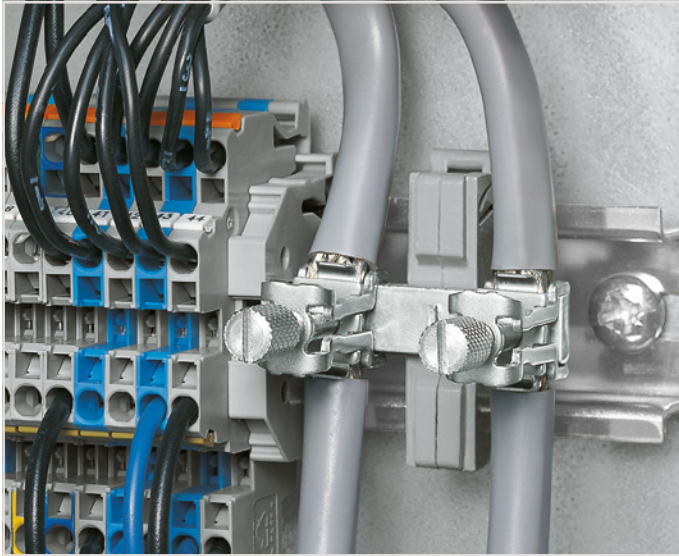
After connection, tighten the knurled screw to  
complete the installation. Recommended tighten-  
ing torque: 0.5 Nm



To remove the clamping saddle, unscrew until  
ratcheted mechanism is released, then slightly tip  
saddle and remove the clamping saddle.

10

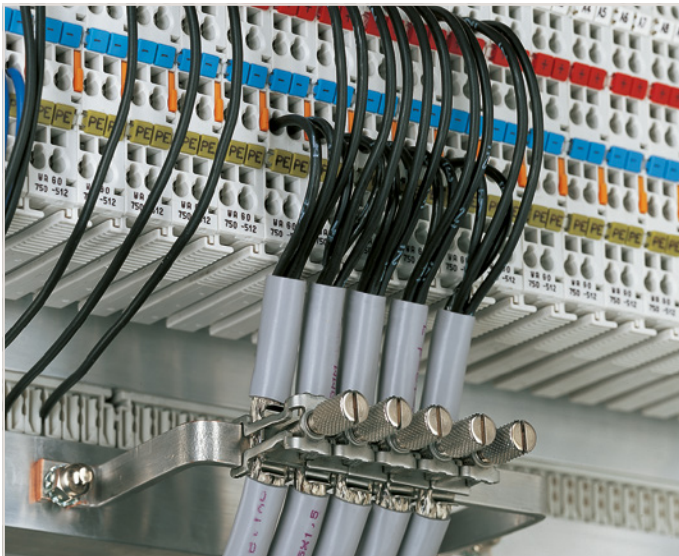
# Shield Connection System, 790 Series Application and Installation Instructions



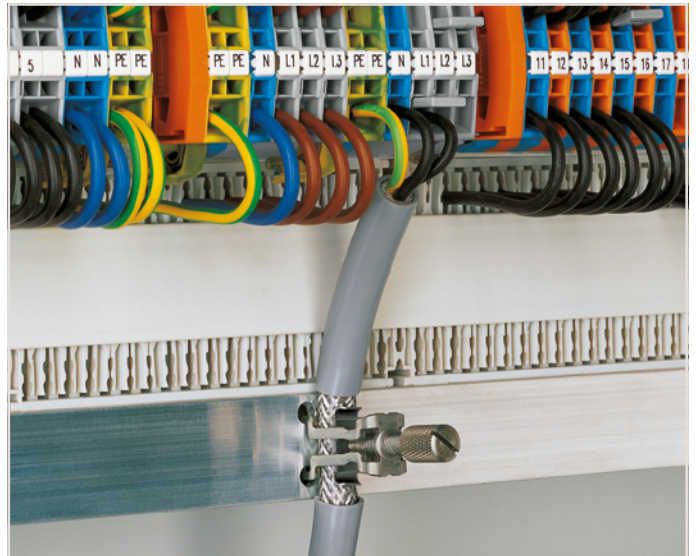
Carrier with grounding foot – busbar parallel to the rail



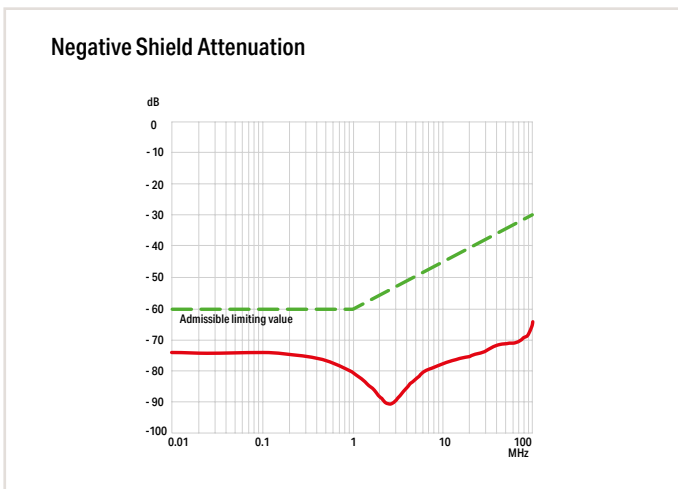
Insulated mounting carriers for a common shield reference potential, independent of housing potential



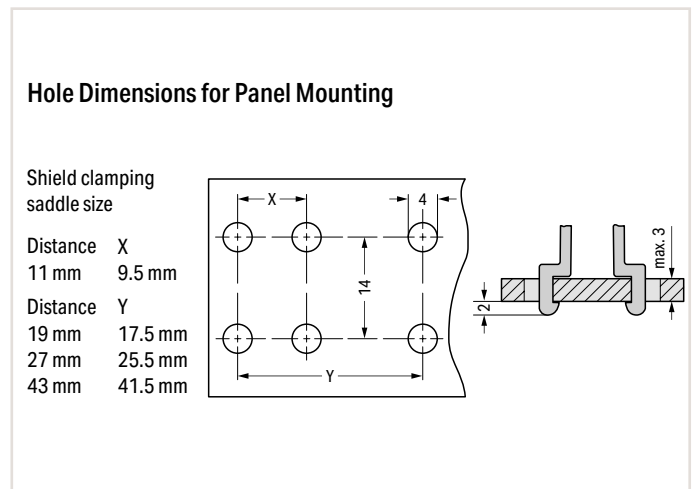
U-shaped (10 x 3) mm copper busbar



Snap shield clamping saddles into any metal plate (max. thickness: 3 mm).



WAGO's shield connection system is highly effective because the clamping unit can be brought very close to the unshielded part of the cable.



Additionally, the spring material is part of the clamping saddle, providing a good electrical connection (the system also acts as a partial strain relief). The spring element integrated in the shield clamping saddle compensates deformation and settling that results from a connected shield.

# Shield Clamping Saddle 790 Series



Shield clamping saddle; 11 mm wide;  
Connectable shield diameter: up to 8 mm

Item No.	Pack. Unit
790-108	50 (10)



Shield clamping saddle; 19 mm wide;  
Connectable shield diameter: 7 ... 16 mm

Item No.	Pack. Unit
790-116	50 (10)



Shield clamping saddle; 27 mm wide;  
Connectable shield diameter: 6 ... 24 mm

Item No.	Pack. Unit
790-124	50 (10)



Shield clamping saddle; 43 mm wide;  
Connectable shield diameter: 22 ... 40 mm

Item No.	Pack. Unit
790-140	50 (10)

### Installation

The shield clamping saddle is shipped ready for direct connection to the (10 x 3) mm busbar or to a drilled mounting plate. After connection, tighten the knurled screw to complete the installation. Maximum tightening torque: 0.5 Nm

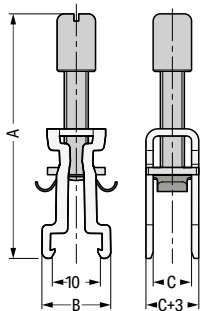


### Removal

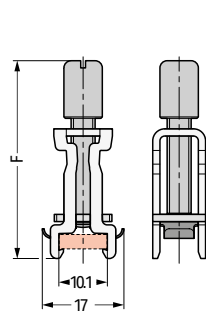
To remove the clamping saddle, unscrew until ratcheted mechanism is released, then slightly tip saddle and remove the clamping saddle.



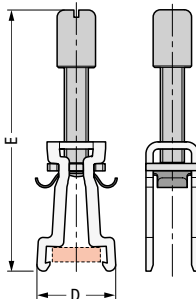
Delivery position –  
for direct snapping



Snapping position  
closed



Release position



Dimensions in mm

Item No.	A	B	C	D	E	F
790-108	51	15	8	16	55	42
790-116	53	15	16	16	57	45
790-124	78	15	24	16	83	58
790-140	97	15	40	16	100	73

10

# Spring-Equipped Shield Clamping Saddle 790 Series



Shield clamping saddle; 3 ... 8 mm diameter; 12.4 mm wide		
Item No.	Pack. Unit	
790-208	50	



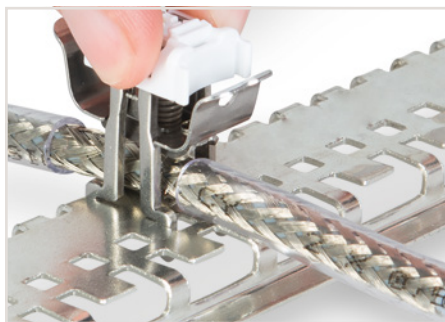
Shield clamping saddle; 6 ... 16 mm diameter; 21.8 mm wide		
Item No.	Pack. Unit	
790-216	25	



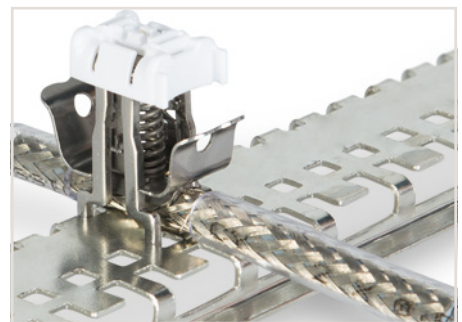
Shield clamping saddle; 6 ... 20 mm diameter; 30 mm wide		
Item No.	Pack. Unit	
790-220	25	



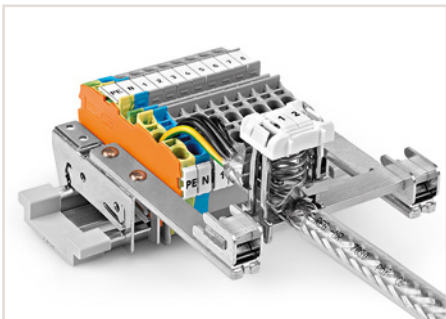
Mounting a clamping saddle on a specialty slotted DIN-rail (790-145).  
When releasing the saddle, do not place your finger under the clamping spring!



Removing the shield clamping saddle.



Shield clamping saddle contacts shield conductor and specialty slotted DIN-rail (790-145).



Application example

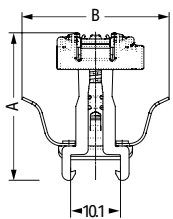


Labeling using a marking strip.

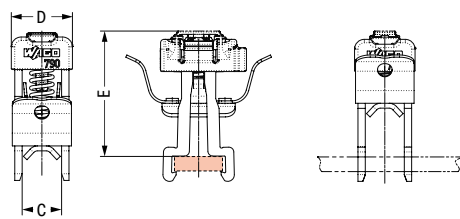


Labeling using WMB markers.

Delivery position



Mounting position



Dimensions in mm

Item No.	A	B	C	D	E*
790-208	30	29.9	8	12.4	25.8
790-216	34.6	28.3	16	21.8	30.2
790-220	45.6	28.3	24	30	41.2

\*Height with WMB marker

# Shield Clamp and Shield Termination 791 and 709 Series



Shield clamp; Connectable shield diameter:  
1.5 ... 6.5 mm; Height: 40 mm (max.); 10 mm wide

Item No.	Pack. Unit
791-107	50

Shield clamp; Connectable shield diameter:  
5 ... 11 mm; Height: 47 mm (max.); 17 mm wide

Item No.	Pack. Unit
791-111	50

Shield clamp; Connectable shield diameter:  
10 ... 17 mm; Height: 63 mm (max.); 23 mm wide

Item No.	Pack. Unit
791-117	50

Shield clamp; Connectable shield diameter:  
16 ... 24 mm; Height: 78 mm (max.); 30 mm wide

Item No.	Pack. Unit
791-124	50



Shield termination; includes cable ties for  
5 ... 10 mm shield diameter;  
60 mm long

Item No.	Pack. Unit
709-350	100 (25)

Shield termination; includes cable ties for  
5 ... 10 mm shield diameter;  
150 mm long

Item No.	Pack. Unit
709-352	100 (25)



Insert the shield termination into the female plug using the operating tool.



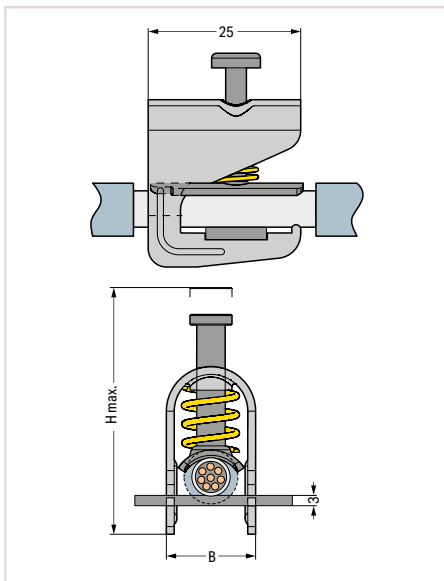
Fit the shield termination to the shield cable.



Secure both shield cable and shield termination to the strain relief plate using cable ties.

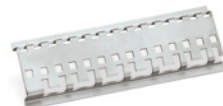


Shield termination connected to an X-COM® female plug



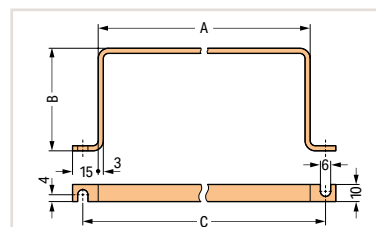
Dimensions in mm

## Accessories for Shield Connection Systems

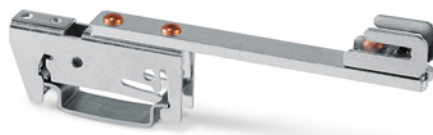


Item Description				Item No.	Pack. Unit
<b>Carrier with grounding foot</b>					
Carrier with grounding foot; Busbar parallel to the rail; 15 mm long; Copper (10 x 3) mm; suitable for shield clamping saddles (790-108)				790-110	25
Carrier with grounding foot; Busbar parallel to the rail; 25 mm long; Copper (10 x 3) mm; suitable for shield clamping saddles (790-108; 790-116) and shield clamps (791-111; 791-117)				790-112	25
Carrier with grounding foot; Busbar 90° to the DIN-rail; 45 mm long; Copper (10 x 3) mm; suitable for shield clamping saddles (790 Series)				790-113	25
Carrier with grounding foot; Busbar parallel to the DIN-rail; 45 mm long; Copper (10 x 3) mm; suitable for shield clamping saddles (790 Series) and shield clamps (791 Series)				790-114	25
<b>Carrier with two grounding feet</b>					
Carrier with two grounding feet; Busbar parallel to the DIN-rail; 125 mm long; Copper (10 x 3) mm				790-115	25
<b>Busbar</b>					
Busbar; tin-plated; 1000 mm long; Copper (10 x 3) mm				210-133	1
Busbar; tin-plated; 30 mm long; Copper (10 x 3) mm				790-133	20
Busbar; tin-plated; 50 mm long; Copper (10 x 3) mm				790-134	20
<b>DIN-rail; specialty slotted</b>					
DIN-rail; specialty slotted; 1000 mm long; tin-plated				790-145	1
Spacer sleeve; for DIN-rail; suitable for M5-size screw; specialty slotted				790-144	200 (100)
<b>Insulated mounting foot</b>					
Insulated mounting foot; for busbar with M4 x 8 mm screw				790-100	50 (25)
Insulated mounting foot; for busbar with (3.5 x 9) mm sheet metal screw				790-101	50 (25)
<b>U-shaped busbar; suitable for 750 Series I/O Modules</b>					
	A	B	C		
U-shaped busbar; Copper (10 x 3) mm; for 5 I/O	63	60	83	790-190	25 (5)
U-shaped busbar; Copper (10 x 3) mm; for 8 I/O	100	60	118	790-191	25
U-shaped busbar; Copper (10 x 3) mm; for 5 I/O	63	35	83	790-192	25
U-shaped busbar; Copper (10 x 3) mm; for 5 I/O	100	35	118	790-193	25

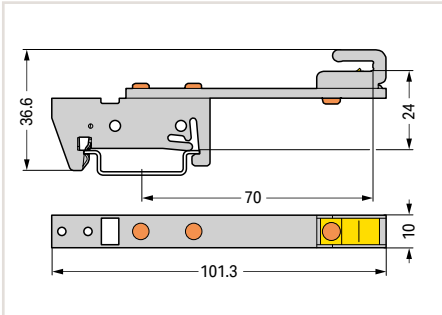
Dimensions in mm



# Busbar Carrier 790 Series



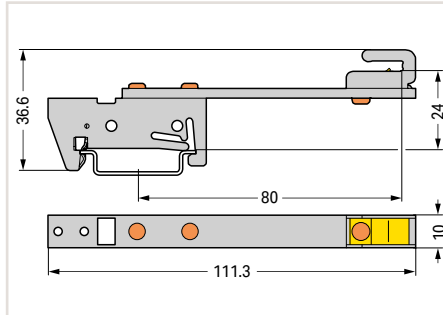
Dimensions in mm



Busbar carrier; for (10 x 3) mm copper busbars; single side; straight; snaps onto DIN-35 rail

Item No.	Pack. Unit
790-300	10

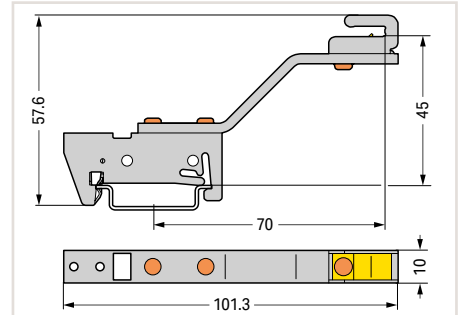
Dimensions in mm



Busbar carrier; for (10 x 3) mm copper busbars; single side; straight; snaps onto DIN-35 rail

Item No.	Pack. Unit
790-302	10

Dimensions in mm

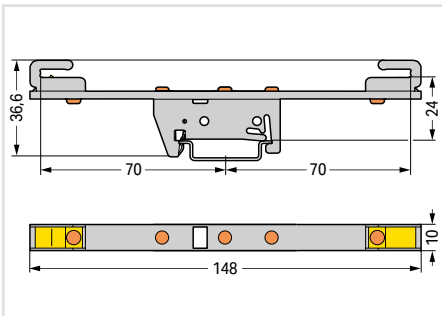


Busbar carrier; for (10 x 3) mm copper busbars; single side; angled; snaps onto DIN-35 rail

Item No.	Pack. Unit
790-301	10



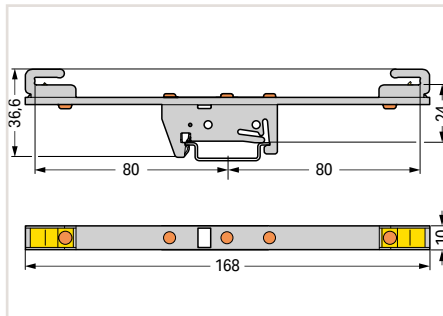
Dimensions in mm



Busbar carrier; for (10 x 3) mm copper busbars; both sides; straight; snaps onto DIN-35 rail

Item No.	Pack. Unit
790-310	10

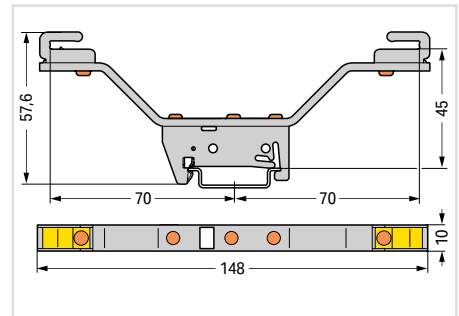
Dimensions in mm



Busbar carrier; for (10 x 3) mm copper busbars; both sides; straight; snaps onto DIN-35 rail

Item No.	Pack. Unit
790-312	10

Dimensions in mm



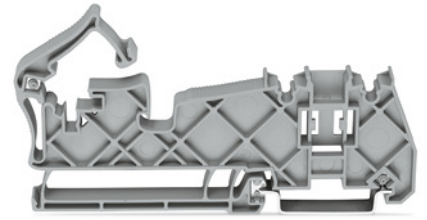
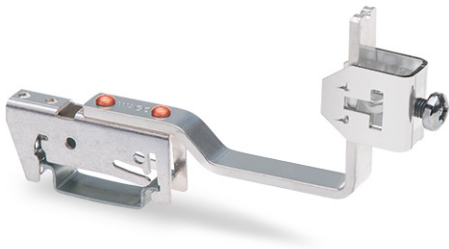
Busbar carrier; for (10 x 3) mm copper busbars; both sides; angled; snaps onto DIN-35 rail

Item No.	Pack. Unit
790-311	10

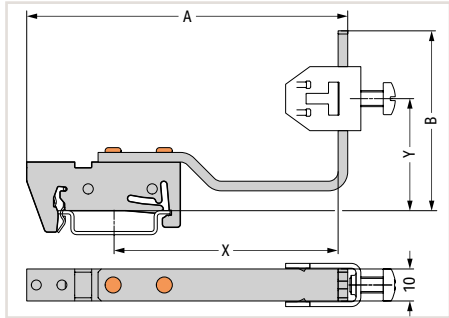
10



# Busbar Carrier 790 Series



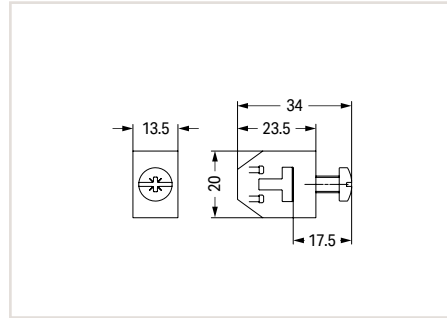
Dimensions in mm



Busbar carrier; for (10 x 3) mm copper busbars; flexible; snaps onto DIN-35 rail

Item No.	Pack. Unit
790-350/790-398	12
790-352/790-398	12
790-360/790-398	12
790-362/790-398	25

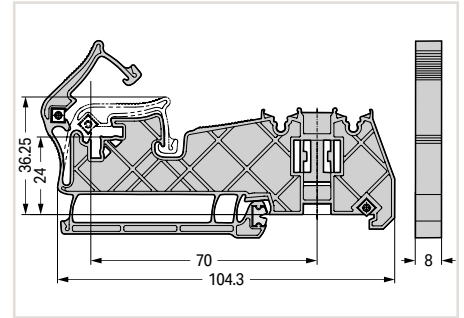
Dimensions in mm



T-connector; for (10 x 3) mm copper busbars

Item No.	Pack. Unit
790-398	10

Dimensions in mm

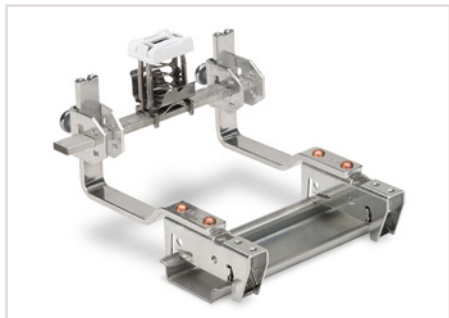


Busbar carrier; for (10 x 3) mm copper busbars; no contact to DIN-rail; insulated

Color	Item No.	Pack. Unit
gray	790-400	20

Dimensions in mm

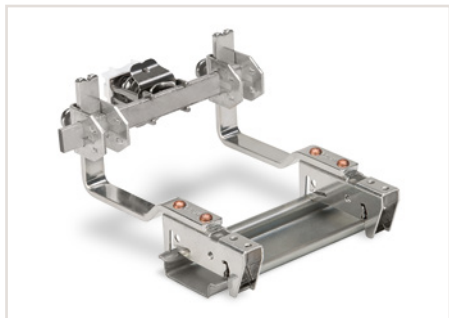
Item No.	A	B	X	Y
790-350/790-398	100	56	70	15 ... 52
790-352/790-398	100	99	70	15 ... 92
790-360/790-398	115	56	85	15 ... 52
790-362/790-398	115	99	85	15 ... 92



Horizontal mounting position of the busbar



Horizontal mounting position of the busbar



Vertical mounting position of the busbar



Vertical mounting position of the busbar

## Mini-WSB Marking Card; as Card and Mini-WSB Inline; for Smart Printer; on Reel



### Mini-WSB Marking Card; as card; not stretchable; plain; snap-on type

Color	Item No.	Pack. Unit
white	248-501	5
yellow	248-501/000-002	5
red	248-501/000-005	5
blue	248-501/000-006	5
gray	248-501/000-007	5
orange	248-501/000-012	5
light green	248-501/000-017	5
green	248-501/000-023	5
violet	248-501/000-024	5

### Mini-WSB Inline; for Smart Printer; on reel; stretchable 5 ... 5.2 mm; plain; snap-on type

Color	Item No.	Pack. Unit
white	2009-145	1

### Mini-WSB Marking Card; as card; with marking; not stretchable; horizontal marking; snap-on type

Marking	No. of Markings	Color	Item No.	Pack. Unit
0V	100x	blue	247-506/000-006	5
0V	100x	white	247-506	5
-	100x	blue	247-507/000-006	5
-	100x	white	247-507	5
24 V	100x	red	247-508/000-005	5
24 V	100x	white	247-508	5
+	100x	red	247-509/000-005	5
+	100x	white	247-509	5
⊕	100x	light green	247-552/000-017	5
⊕	100x	white	247-552	5
PE	100x	light green	248-578/000-017	5
PE	100x	white	248-578	5
A0 A1 ... A8 A9	10x	white	247-510	5
E0 E1 ... E8 E9	10x	white	247-511	5
X0 X1 ... X8 X9	10x	white	247-512	5
00 ... 09	10x	white	247-513	5
10 ... 19	10x	white	247-514	5
20 ... 29	10x	white	247-515	5
30 ... 39	10x	white	247-516	5
40 ... 49	10x	white	247-517	5
50 ... 59	10x	white	247-518	5
60 ... 69	10x	white	247-519	5
70 ... 79	10x	white	247-520	5
80 ... 89	10x	white	247-521	5
90 ... 99	10x	white	247-522	5
00 ... 49	2x	white	247-523	5
50 ... 99	2x	white	247-524	5
100 ... 149	2x	white	247-525	5
150 ... 199	2x	white	247-526	5
200 ... 249	2x	white	247-527	5
250 ... 299	2x	white	247-528	5
300 ... 349	2x	white	247-529	5
350 ... 399	2x	white	247-530	5
400 ... 449	2x	white	247-531	5
450 ... 499	2x	white	247-532	5
500 ... 549	2x	white	247-533	5
550 ... 599	2x	white	247-534	5
600 ... 649	2x	white	247-535	5
650 ... 699	2x	white	247-536	5
700 ... 749	2x	white	247-537	5
750 ... 799	2x	white	247-538	5
800 ... 849	2x	white	247-539	5
850 ... 899	2x	white	247-540	5
900 ... 949	2x	white	247-541	5
950 ... 999	2x	white	247-542	5
.0 ... 7 / frei	10x/20x	white	247-543	5
.0 ... 7 /-	10x/20x	white	247-544	5
.0 ... 7 /-	10x/20x	blue	247-544/000-006	5
.0 ... 7 /+	10x/20x	white	247-545	5
.0 ... 7 /+	10x/20x	red	247-545/000-005	5
.0 ... 7 /N	10x/20x	white	247-546	5
.0 ... 7 /N	10x/20x	blue	247-546/000-006	5
.0 ... 7 /L	10x/20x	white	247-547	5

# Marking Card and Group Marker Carrier



Figure: 750-103

Marking Card; as DIN A4 sheet; plain		
	Item No.	Pack. Unit
	750-100	1

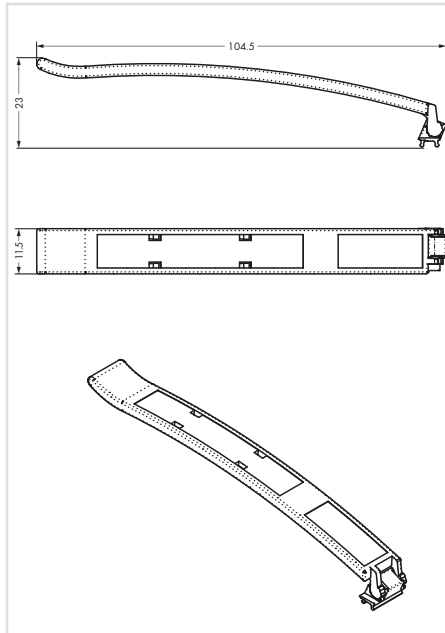


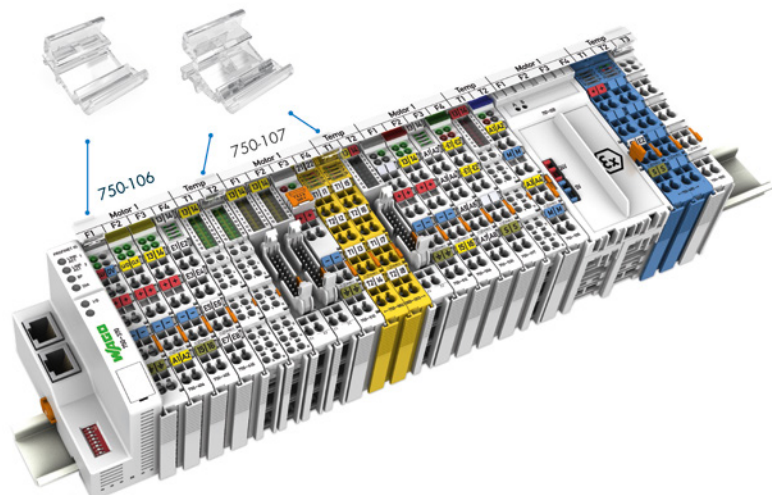
Figure: 750-106

Figure: 750-107

Item Description
Item No.
Technical Data
Dimensions W x D
Material
Weight
Data sheet and further information, see:
Accessories
Marking strip; on reel; 7.5 mm wide; not stretchable; plain; snap-on type
Marking Card; as DIN A4 sheet; plain
Marking strip; on reel; not stretchable; plain; snap-on type
WMB Inline; for Smart Printer; on reel; stretchable 5 ... 5.2 mm; plain; snap-on type

Group Marker Carrier
Item No.
750-103
Dimensions W x D
11.5 x 104.5 mm
Material
Polycarbonate
Weight
2.84 g
Data sheet and further information, see:
wago.com/750-103
Item No.
709-178
750-105

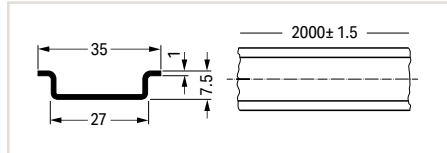
Group Marker Carrier	
4 LEDs (max.)	8/16 LEDs (max.)
750-106	750-107
Material	Polycarbonate
Weight	0.4 g
Data sheet and further information, see:	wago.com/750-106   wago.com/750-107
Item No.	
2009-110	
2009-115	



# Steel DIN-Rail



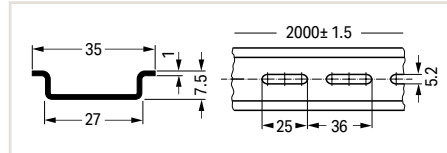
Dimensions in mm



**Steel DIN-rail; unslotted;**  
**IN 76 A (based on 1 m length);**  
**35 x 7.5 mm; 1 mm thick, 2 m long**

	Item No.	Pack. Unit
per EN 60715	210-113	10
similar to EN 60715	210-505	1

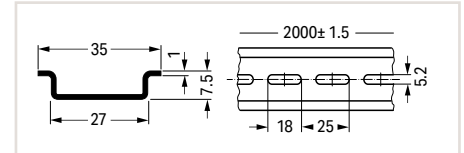
Dimensions in mm



**Steel DIN-rail; slotted;**  
**IN 76 A (based on 1 m length);**  
**35 x 7.5 mm; 1 mm thick; 2 m long;**  
**25 mm hole width; 36 mm hole spacing**

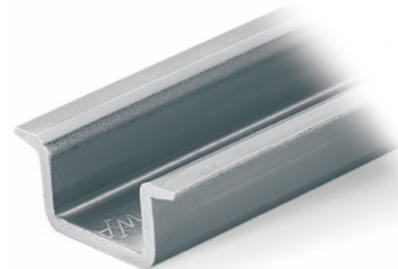
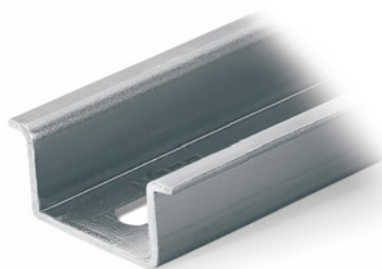
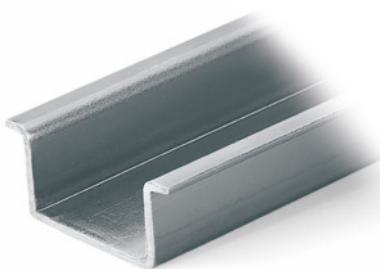
	Item No.	Pack. Unit
per EN 60715	210-112	10 (1)
similar to EN 60715	210-504	1

Dimensions in mm

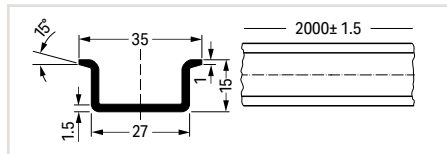


**Steel DIN-rail; slotted;**  
**IN 76 A (based on 1 m length);**  
**35 x 7.5 mm; 1 mm thick; 2 m long;**  
**18 mm hole width; 25 mm hole spacing**

	Item No.	Pack. Unit
per EN 60715	210-115	1



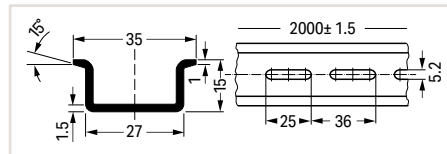
Dimensions in mm



**Steel DIN-rail; unslotted;**  
**IN 125 A (based on 1 m length);**  
**35 x 15 mm; 1.5 mm thick; 2 m long**

	Item No.	Pack. Unit
per EN 60715	210-114	10
similar to EN 60715	210-506	1

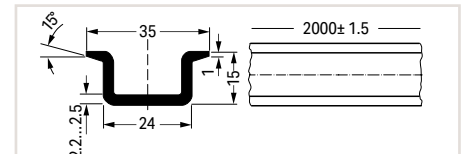
Dimensions in mm



**Steel DIN-rail; slotted;**  
**IN 125 A (based on 1 m length);**  
**35 x 15 mm; 1.5 mm thick; 2 m long;**  
**25 mm hole width; 36 mm hole spacing**

	Item No.	Pack. Unit
per EN 60715	210-197	10
similar to EN 60715	210-508	1

Dimensions in mm



**Steel DIN-rail; unslotted;**  
**IN 125 A (based on 1 m length);**  
**35 x 15 mm; 2.3 mm thick; 2 m long**

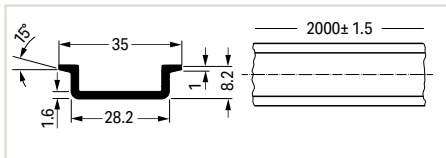
	Item No.	Pack. Unit
per EN 60715	210-118	10

10

# Aluminum DIN-Rail; Copper DIN-Rail; Angled Support Bracket; Rail End Cap



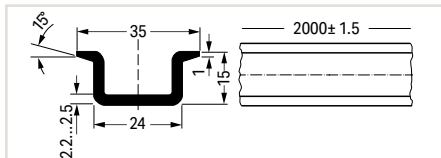
Dimensions in mm



Aluminum DIN-rail; unslotted;  
IN 76 A (based on 1 m length);  
35 x 8.2 mm; 1.6 mm thick; 2 m long

	Item No.	Pack. Unit
similar to EN 60715	210-196	10

Dimensions in mm

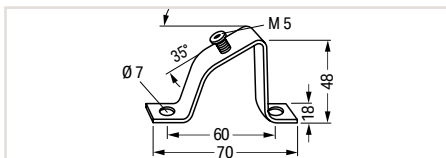


Copper DIN-rail; unslotted;  
IN 309 A (based on 1 m length);  
35 x 15 mm; 2.3 mm thick; 2 m long

	Item No.	Pack. Unit
similar to EN 60715	210-198	10



Dimensions in mm



Angled support bracket

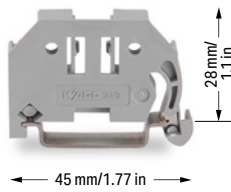
	Item No.	Pack. Unit
without screw	210-148	10
M5 x 8 screw	210-149	100 (20)



Rail end cap; for DIN-35 rail (7.5 mm high)

Color	Item No.	Pack. Unit
gray	209-109	50 (25)

# Screwless End Stop



Screwless end stop; 6 mm wide		
Color	Item No.	Pack. Unit
gray	249-116	100 (25)



Screwless end stop; 14 mm wide		
Color	Item No.	Pack. Unit
gray	249-197	10

Screwless end stop; 10 mm wide		
Color	Item No.	Pack. Unit
gray	249-117	50 (25)

Snap on – that’s it! Assembling the new WAGO Screwless End Stop is as simple and quick as snapping a WAGO Rail-Mount Terminal Block onto the DIN-rail.

**Tool free!**

A tool-free design allows rail-mount terminal blocks to be safely and economically secured against any movement on all DIN-35 rails per DIN EN 50022 (35 x 7.5 mm; 35 x 15 mm).

**Entirely without screws!**

The “secret” to a perfect fit lies in the two small clamping plates which keep the end stop in position, even if the rails are mounted vertically.

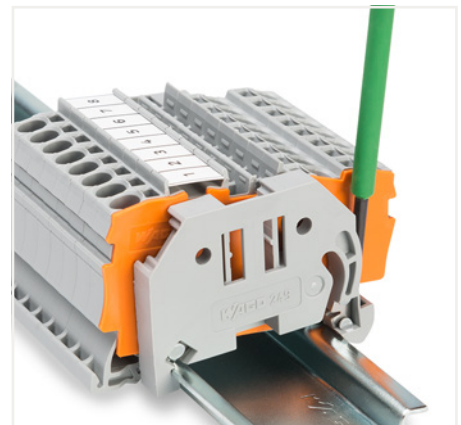
**Simply snap on – that’s it!**

In addition, costs are significantly reduced when using large numbers of end stops.

Additional benefit: Three marker slots for all WAGO Rail-Mount Terminal Block Marking Systems and one snap-in hole for WAGO’s adjustable height group marker carriers offer individual marking options.



Snapping an end stop onto the DIN-rail.



Removing an end stop from the DIN-rail.

## Operating Tool and Cable Cutter



Operating tool with a partially insulated shaft; Type 1; (2.5 x 0.4) mm blade		
Item No.	Pack. Unit	
210-719	50 (1)	

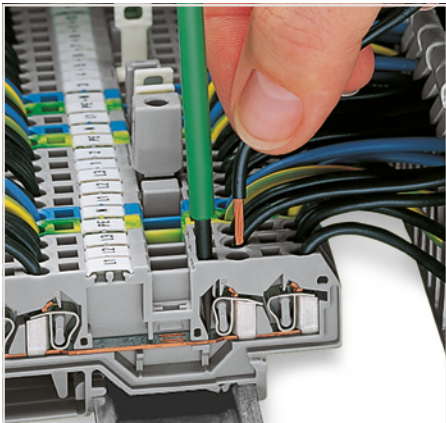
Operating tool with a partially insulated shaft; Type 2; (3.5 x 0.5) mm blade		
Item No.	Pack. Unit	
210-720	50 (1)	

Operating tool with a partially insulated shaft; Type 3; (5.5 x 0.8) mm blade		
Item No.	Pack. Unit	
210-721	25 (1)	

Set of operating tools with a partially insulated shaft; Type 1; (2.5 x 0.4) mm blade; Type 2; (3.5 x 0.5) mm blade; Type 3; (5.5 x 0.8) mm blade		
Item No.	Pack. Unit	
210-722	1	



Cable cutter; for copper and aluminum cables up to 35 mm <sup>2</sup>		
Item No.	Pack. Unit	
206-118	1	



The blade dimensions of the above-listed operating tools with a partially insulated shaft are ideal for easy operation of front-entry terminal blocks.



Cutting a cable.

## Cable Stripper



Cable knife; for  $\varnothing$  8 ... 28 mm / 0.31 ... 1.10 inch; with a unique, changeable cable bracket system; including cable bracket

Item No.	Pack. Unit
206-1403	1

### Accessories

Item No.	Pack. Unit
206-1418	1
206-1419	1

### Cable bracket

	Item No.	Pack. Unit
for $\varnothing$ 4 ... 16 mm / 0.16 ... 0.63 inch	206-1411	1
for $\varnothing$ 8 ... 28 mm / 0.31 ... 1.10 inch	206-1412	1
for $\varnothing$ 27 ... 35 mm / 1.06 ... 1.38 inch	206-1413	1
for $\varnothing$ 35 ... 50 mm / 1.38 ... 1.97 inch	206-1414	1
for $\varnothing$ 50 ... 70 mm / 1.97 ... 2.75 inch	206-1415	1

Cable knife set; for  $\varnothing$  4 ... 70 mm / 0.16 ... 2.75 inch; including all cable brackets in a Sortimo® Box

Item No.	Pack. Unit
206-1400	1



In-socket cable stripper; for  $\varnothing$  8 ... 13 mm / 5/16 ... 1/2 inch

Item No.	Pack. Unit
206-1441	1

Universal cable stripper; for  $\varnothing$  8 ... 13 mm / 5/16 ... 1/2 inch

Item No.	Pack. Unit
206-1442	1

Data cable stripper; for  $\varnothing$  4.5 ... 10 mm / 3/16 ... 3/8 inch

Item No.	Pack. Unit
206-1451	1



### Product features:

- Extra long design and improved force transmission simplifies stripping in deep device connection sockets
- Special four-blade design for an even more precise round cut
- No cutting depth adjustment required
- TiN-coated blades, TÜV/GS tested
- $\varnothing$  8 ... 13 mm / 5/16 ... 1/2 inch
- Strips all standard round cables, including NYM 3 x 1.5 mm<sup>2</sup> ... 5 x 2.5 mm<sup>2</sup>

### Product features:

- Secure grip achieved with soft padding for non-slip grips
- Technically improved functionality
- New locking mechanism prevents the unwanted opening of the tool
- Absolutely straightforward, quick and easy longitudinal cuts – with innovative internal cable duct
- Redesigned blade layout and intake to stop cable waste from jamming the tool
- Durable and ergonomically designed pocket clip
- $\varnothing$  8 ... 13 mm / 5/16 ... 1/2 inch

### Product features:

- Strip outer insulation and foil sheathing with one tool
- Ideal for stripping PVC-insulated data cables with thin insulation (e.g., Cat 5, Cat 6, Cat 7, twisted-pair cables)
- TiN-coated blades
- $\varnothing$  4.5 ... 10 mm / 3/16 ... 3/8 inch



## Cable Stripper; Wire Stripper



Stripping pliers; for sensor cables		
	Item No.	Pack. Unit
	206-1481	1

Stripping pliers; for control cables		
	Item No.	Pack. Unit
	206-1482	1

Accessories		
	Item No.	Pack. Unit
Replacement blade set; for $\varnothing$ 3.2 ... 4.4 mm / 0.13 ... 0.17 inch	206-1491	1

Accessories		
	Item No.	Pack. Unit
Replacement blade set; for $\varnothing$ 4.4 ... 7 mm / 0.17 ... 0.27 inch	206-1492	1

The stripping pliers for sensor cables have a blade geometry specially designed for sensor cables with a smaller cross section and a working range from  $\varnothing$  3.2 mm (for stranded cables and round cables with  $\varnothing$  3.2 mm ... 4.4 mm / 0.13 ... 0.17 inch).

The stripping pliers for control cables are designed for stronger cables from  $\varnothing$  4.4 mm (for stranded cables and round cables with  $\varnothing$  4.4 mm ... 7 mm / 0.17 ... 0.27 inch).

These stripping pliers quickly and safely strip cables for connecting, e.g., sensor/actuator distribution boxes, bus couplers and pluggable connectors.

Suitable for:

- Halogen-free PUR sensor/actuator cables
- Highly flexible TPE-U cables
- Control cables
- PUR cables
- PUR/PVC cables
- PVC cables
- Multi-core cables
- Shielded and unshielded cables

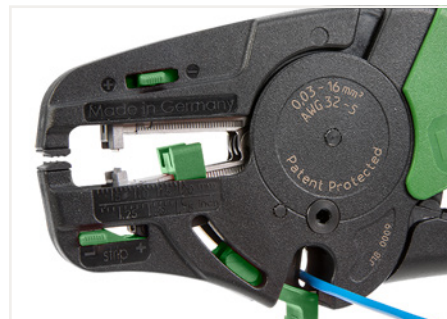
Never use this tool on or near live electrical circuits!



Wire stripper "Quickstrip Vario"; 0.03 ... 16 mm<sup>2</sup> / 34 ... 6 AWG

	Item No.	Pack. Unit
	206-1125	1

Accessories		
	Item No.	Pack. Unit
Blade set; Standard; 0.03 ... 16 mm <sup>2</sup> / 34 ... 6 AWG	206-1126	1
Blade set; V-blade; 0.14 ... 4 mm <sup>2</sup> / 24 ... 12 AWG	206-1127	1
Blade set; Oval blade; 10 ... 16 mm <sup>2</sup> / 8 ... 6 AWG	206-1128	1
Spare stripping stop	206-1129	1
Spare cut protector	206-1131	1
Spare clamping jaws	206-1132	1



Cutting a conductor.



Partially stripping a conductor.

Wire Stripper:

- Automatically adjust to conductor size
- Stripping blades cause no damage to conductor strands
- Gripping pressure of jaws adjusts automatically to conductor insulation diameter
- Clamping jaws and stripping blades automatically open once the stripping process is completed – no splaying of the conductor strands
- Exact strip length may be set by sliding black setting stop
- Stripping blades can be replaced
- Self-sharpening, fully protected cutter (replaceable)
- Entire body made of glass-fiber-reinforced polyamide
- Cutting capacity of the wire cutter of fine-stranded conductors up to 16 mm<sup>2</sup> (6 AWG)

# Test and Measurement Device

## 206 Series



Multi-Tester; digital multimeter with non-contact voltage tester		Clamp-Multi-Tester		Testboy; with integrated flashlight, non-contact voltage tester	
Item No.	Pack. Unit	Item No.	Pack. Unit	Item No.	Pack. Unit
206-810	1	206-816	1	206-804	1



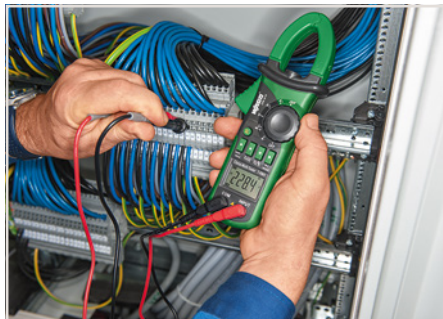
- Additional Multi-Tester features:
- Contact-less voltage test AC >100 V (optical and acoustical)
  - Resistance measurement up to 20 MΩ
  - Acoustical continuity test
  - Diode test
  - Data hold function
  - Auto power-off function
  - LED torch lamp function
  - CAT IV 600 V
  - TÜV/GS tested and approved
  - IEC/EN 61010-1 (DIN VDE 0411)



- Voltage testing in control cabinet:
- Additional Clamp-Multi-Tester features:
    - DC and AC current up to 600 A
    - True RMS and min./max. value measurement
    - DC and AC voltage up to 600 V
    - Manual or automatic measurement range selection
    - Resistance up to 60 MΩ
    - Capacitance measurement, acoustical continuity test
    - Diode test, data hold function
    - Large LCD with backlight
    - LED measuring point lighting
    - CAT III 600 V overvoltage protection
    - IEC/EN 61010-1 (DIN VDE 0411)
  - Includes batteries, measurement leads and carrying bag



- A device that will reliably detect AC voltage in cables, sockets, fuses, switches, outlets and other installations. Testboy can detect the following:
- Live conductors
  - Cable breaks
  - Blown fuses (in cartridges or holders)
  - Defective switches
  - Defective lamps in strings of lights



Current measurement in a control cabinet

## Test and Measurement Devices

### 206 Series



**Profi-LCD+; 2-pole voltage tester with LCD display; removable 4 mm Ø test probes**

Item No.	Pack. Unit
206-707	1



**Profi-LED+; 2-pole voltage tester with LED display; removable 4 mm Ø test probes**

Item No.	Pack. Unit
206-706	1



**Spare test probes; 4 mm Ø (2 pieces)**

Item No.	Pack. Unit
206-808	25



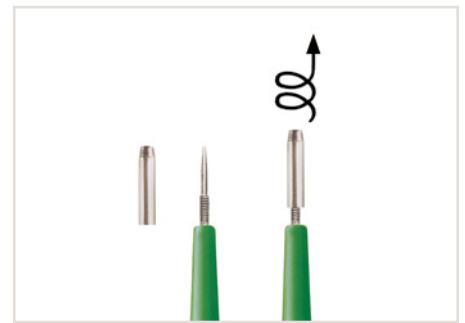
#### Additional Profi-LCD+ features:

- Automatic measurement range selection
- Single-pole phase testing AC > 100 V
- Two-pole sequence testing (R and L)
- Continuity testing
- RDC/RCD testing (30 mA) via buttons
- One-hand operation for SCHUKO® and CEE sockets
- LED torch lamp function
- Automatic backlight
- Auto power-off function
- CAT IV 1000 V
- TÜV/GS tested and approved
- IEC/EN 61243-3 (DIN VDE 0682-401)



#### Additional Profi-LED+ features:

- Automatic measurement range selection
- Single-pole phase testing AC > 100 V
- Two-pole sequence testing (R and L)
- Continuity testing
- RDC/RCD testing (30 mA) via buttons
- One-hand operation for SCHUKO® and CEE sockets
- LED torch lamp function
- CAT IV 1000 V
- TÜV/GS tested and approved
- IEC/EN 61243-3 (DIN VDE 0682-401)



#### Profi-LED+:

- Improved socket contact via 4 mm Ø test probes
- Removable test probes for small test ports (suitable for all WAGO Terminal Blocks)

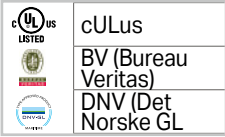
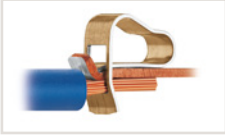
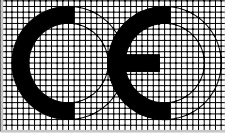







## Technical Section



## Technical Section Contents

	Page
	<b>Approvals Overview</b> 516
	<b>Operating WAGO Connection Technologies</b> 530
	<b>CE Marking and EC Directives</b> 532
	<b>General Technical Information for Electrical Equipment Used in Hazardous Areas</b> 533
<b>Immunity for Industrial Environments</b> <b>Test</b> EN 61000-4-2   ESD	<b>Electromagnetic Compatibility and Mechanical Strength (Industrial and Residential Environments)</b> 534
<b>Immunity for Marine Applications</b> <b>Test</b> IEC 61000-4-2   ESD	<b>Electromagnetic Compatibility and Mechanical Strength (Marine Applications)</b> 535
IEC 61131-1 EN 61131-1 Programmable Logic Controllers – Part 1: General Information	<b>Specifications and Test Results</b> 536
	<b>Electrical Engineering Laboratory: Product Safety for Our Customers</b> 540
	<b>WAGO Seminars</b> 542

# Approvals Overview

## Controllers – PFC100/200, PFC200 XTR, Controllers 750, Controllers 750 XTR

Versions with an extended temperature range (Item No. with Suffix /025-...) see the following pages

	cULus OrdLoc	E175199 Sec. 1, UL 508, UL 61010
	ABS (American Bureau of Shipping)	19-HG1821926-PDA; 18-HG1778162-PDA; 19-HG1821812-PDA
	BV (Bureau Veritas)	13453/D0 BV, 30389/B0 BV
	DNV (Det Norske Veritas) GL (Germanischer Lloyd)	TAA0000194; TAA00000Y7; TAA00001J4; TAA00001FS
	KR (Korean Register of Shipping)	HMB05880-AC001
	LR (Lloyd's Register)	02/20026 (E5); 17/20073 (E2)
	NK (Nippon Kaiji Kyokai)	TA17255M
	Polski Rejestr Statkow	TE/2210/880590/18; TE/2215/880590/18; TE/2214/880590/18
	RINA (Registro Italiano Navale)	ELE343217XG
	cULus HazLoc	E198726 Sec. 1, ANSI/ISA 12.12.01 E480271 Sec. 1, AEx UL60079
	INMETRO	TÜV 12.1297 X; TÜV 14.1911 X
	TÜV	07ATEX554086 X; IECEX TUN 09.0001 X 12ATEX106032 X; IECEX TUN 12.0039 X 14ATEX148929 X; IECEX TUN 14.0035 X 17ATEX193969 X; IECEX TUN 16.0046 X 17ATEX196484 X; IECEX TUN 17.0005 X DEKRA 11ATEX0203 X

Item No.	Item Description	ATEX/IECEX	BRA-Ex	HazLoc	RINA	PRS	NK	LR	KR	DNV GL	BV	ABS	OrdLoc	See Page
<b>PFC100/PFC200 <sup>1)</sup></b>														
			Ex				Marine Approvals					UL		
750-8100	PFC100; 2ETH; Eco	■	■	■	■	■	■	■	■	■	■	■	■	78
750-8101	PFC100; 2ETH	■	■	■	■	■	■	■	■	■	■	■	■	79
750-8102	PFC100; 2ETH RS	■	■	■	■	■	■	■	■	■	■	■	■	79
750-8207	PFC200; 2ETH RS 3G	■	■	■	■	■	■	■	■	■	■	■	□	85
750-8208	PFC200; 2ETH RS CAN DPM	■	■	■	■	■	■	■	■	■	■	■	□	86
750-8212	PFC200; G2; 2ETH RS	■	■	■	■	■	■	■	■	■	■	■	□	80
750-8213	PFC200; G2; 2ETH CAN	■	■	■	■	■	■	■	■	■	■	■	□	81
750-8214	PFC200; G2; 2ETH RS CAN	■	■	■	■	■	■	■	■	■	■	■	□	82
750-8215	PFC200; G2; 4ETH CAN USB	■	■	■	■	■	■	■	■	□	■	■	□	83
750-8216	PFC200; G2; 2ETH RS CAN DPS	■	■	■	■	■	■	■	■	■	■	■	□	84
<b>PFC200 XTR <sup>1)</sup></b>														
750-8202/040-000	PFC200; 2ETH RS; XTR	■	■	■	■	■	■	■	■	■	■	■	■	100
750-8202/040-001	PFC200; 2ETH RS; Tele; XTR	■	■	■	■	■	■	■	■	■	■	■	■	100
750-8206/040-000	PFC200; 2ETH RS CAN DPS; XTR	■	■	■	■	■	■	■	■	■	■	■	■	101
750-8206/040-001	PFC200; 2ETH RS CAN DPS; Tele; XTR	■	■	■	■	■	■	■	■	■	■	■	■	101
<b>Controllers 750 <sup>1)</sup></b>														
750-806	Controller DeviceNet	■	■	■	■	■	■	■	■	■	■	■	■	116
750-815/300-000	Controller Modbus®; RS485; 115.2kBd	■	■	■	■	■	■	■	■	■	■	■	■	117
750-816/300-000	Controller Modbus®; RS232; 115.2kBd	■	■	■	■	■	■	■	■	■	■	■	■	117
750-829	Controller BACnet MS/TP	■	■	■	■	■	■	■	■	■	■	■	■	115
750-831	Controller BACnet/IP	■	■	■	■	■	■	■	■	■	■	■	■	114
750-833	Controller PROFIBUS Slave	■	■	■	■	■	■	■	■	■	■	■	■	118
750-837	Controller CANopen; M1; MCS	■	■	■	■	■	■	■	■	■	■	■	■	119
750-838	Controller CANopen; M1; DSub	■	■	■	■	■	■	■	■	■	■	■	■	119
750-842	Controller ETHERNET; G1	■	■	■	■	■	■	■	■	■	■	■	■	112
750-843	Controller ETHERNET; G1; Eco	■	■	■	■	■	■	■	■	■	■	■	■	112
750-852	Controller ETHERNET; G3; Eco	■	■	■	■	■	■	■	■	■	■	■	■	111
750-862	Controller Modbus TCP; G4; Eco	■	■	■	■	■	■	■	■	■	■	■	□	111
750-880	Controller ETHERNET; G3; SD	■	■	■	■	■	■	■	■	■	■	■	■	108
750-881	Controller ETHERNET; G3	■	■	■	■	■	■	■	■	■	■	■	■	109
750-882	Controller ETHERNET; G3; MR	■	■	■	■	■	■	■	■	■	■	■	■	110
750-885	Controller ETHERNET; G3; SD; MR	■	■	■	■	■	■	■	■	■	■	■	■	110
750-889	Controller KNX/IP	■	■	■	■	■	■	■	■	■	■	■	■	113
750-890	Controller Modbus TCP; G4; SD	■	■	■	■	■	■	■	■	■	■	■	□	109
750-891	Controller Modbus TCP; G4	■	■	■	■	■	■	■	■	■	■	■	□	109
<b>Controllers 750 XTR <sup>1)</sup></b>														
750-838/040-000	Controller CANopen; M3 DSub XTR	■	■	■	■	■	■	■	■	■	■	■	■	127
750-880/040-000	Controller ETHERNET; G3; SD; XTR	■	■	■	■	■	■	■	■	■	■	■	■	126
750-880/040-001	Controller ETHERNET; G3; SD; Tele; XTR	■	■	■	■	■	■	■	■	■	■	■	■	126











<sup>1)</sup> Notice: WAGO's 750-626 Filter Module is mandatory for marine approval (observe power supply instructions)!

■ Approval is available. □ Approval is pending.

# Approvals Overview

## Fieldbus Couplers – I/O System 750; Fieldbus Connectors

Versions with an extended temperature range (Item No. with Suffix /025-...) see the following pages

	cULus OrdLoc	E175199 Sec. 1, UL 508, UL 61010
	ABS (American Bureau of Shipping)	19-HG1821926-PDA; 18-HG1778162-PDA; 19-HG1821812-PDA
	BV (Bureau Veritas)	13453/D0 BV, 30389/B0 BV
	DNV (Det Norske Veritas) GL (Germanischer Lloyd)	TAA0000194; TAA00000Y7; TAA00001J4; TAA00001FS
	KR (Korean Register of Shipping)	HMB05880-AC001
	LR (Lloyd's Register)	02/20026 (E5); 17/20073 (E2)
	NK (Nippon Kaiji Kyokai)	TA17255M
	Polski Rejestr Statkow	TE/2210/880590/18; TE/2215/880590/18; TE/2214/880590/18
	RINA (Registro Italiano Navale)	ELE343217XG
	cULus HazLoc	E198726 Sec. 1, ANSI/ISA 12.12.01 E480271 Sec. 1, AEx UL60079
	INMETRO	TÜV 12.1297 X; TÜV 14.1911 X
	TÜV	07ATEX554086 X; IECEx TUN 09.0001 X 12ATEX106032 X; IECEx TUN 12.0039 X 14ATEX148929 X; IECEx TUN 14.0035 X 17ATEX193969 X; IECEx TUN 16.0046 X 17ATEX196484 X; IECEx TUN 17.0005 X DEKRA 11ATEX0203 X

Item No.	Item Description	ATEX/IECEX	BRA-Ex	HazLoc	RINA	PRS	NK	LR	KR	DNV GL	BV	ABS	OrdLoc	See Page
<b>Fieldbus Couplers – I/O System 750 <sup>1)</sup></b>														
		Ex	Marine Approvals										UL	
750-303	FC PROFIBUS; G1; 12MBd	■	■	■	■	■	■	■	■	■	■	■	■	149
750-304	FC INTERBUS	■	■	■	■	■	■	■	■	■	■	■	■	160
750-306	FC DeviceNet	■	■	■	■	■	■	■	■	■	■	■	■	155
750-307	FC CANopen	■	■	■	■	■	■	■	■	■	■	■	■	156
750-310	FC CC-Link	■	■	■	■	■	■	■	■	■	■	■	■	161
750-315/300-000	FC Modbus®; RS485; 115.2kBd	■	■	■	■	■	■	■	■	■	■	■	■	159
750-316/300-000	FC Modbus®; RS232; 115.2kBd	■	■	■	■	■	■	■	■	■	■	■	■	159
750-331	FC PROFIBUS; FOC; 1.5MBd	■	■	■	■	■	■	■	■	■	■	■	■	150
750-333	FC PROFIBUS; G2; 12MBd	■	■	■	■	■	■	■	■	■	■	■	■	149
750-337	FC CANopen; MCS	■	■	■	■	■	■	■	■	■	■	■	■	156
750-338	FC CANopen; DSub	■	■	■	■	■	■	■	■	■	■	■	■	157
750-342	FC ETHERNET; G1	■	■	■	■	■	■	■	■	■	■	■	■	152
750-343	FC PROFIBUS; 12MBd; Eco	■	■	■	■	■	■	■	■	■	■	■	■	150
750-344	FC INTERBUS; 500kbit/s; Eco	■	■	■	■	■	■	■	■	■	■	■	■	160
750-346	FC DeviceNet; Eco	■	■	■	■	■	■	■	■	■	■	■	■	155
750-347	FC CANopen; MCS; Eco	■	■	■	■	■	■	■	■	■	■	■	■	157
750-348	FC CANopen; DSub; Eco	■	■	■	■	■	■	■	■	■	■	■	■	157
750-351	FC Sercos®	■	■	■	■	■	■	■	■	■	■	■	■	158
750-352	FC ETHERNET; G3	■	■	■	■	■	■	■	■	■	■	■	■	151
750-354	FC EtherCAT®	■	■	■	■	■	■	■	■	■	■	■	■	154
750-362	FC Modbus TCP; G4	■	■	■	■	■	■	■	■	■	■	■	□	151
750-375	FC PROFINET; G3; Adv	■	■	■	■	■	■	■	■	■	■	■	■	148
750-377	FC PROFINET; G3; Eco; Adv	■	■	■	■	■	■	■	■	■	■	■	■	148
<b>Fieldbus Connectors</b>														
750-960	PROFIBUS Fieldbus Connector; with D-sub male connector; 9-pole	■	■	■	■	■	■	■	■	■	■	■	■	478
750-961	INTERBUS Fieldbus Connector (IN); with D-sub female connector; 9-pole	■	■	■	■	■	■	■	■	■	■	■	■	481
750-962	INTERBUS Fieldbus Connector (OUT); with D-sub male connector; 9-pole	■	■	■	■	■	■	■	■	■	■	■	■	481
750-963	CANopen Fieldbus Connector; with D-sub female connector; 9-pole	■	■	■	■	■	■	■	■	■	■	■	■	480
750-965	CC-Link Fieldbus Connector; with D-sub male connector; 9-pole	■	■	■	■	■	■	■	■	■	■	■	■	482
750-975	ETHERNET RJ-45 connector, IP20; ETHERNET 10/100 Mbit/s; for field assembly	■	■	■	■	■	■	■	■	■	■	■	■	472
750-976	PROFINET RJ-45 connector, IP20; ETHERNET 10/100 Mbit/s; for field assembly	■	■	■	■	■	■	■	■	■	■	■	■	476

<sup>1)</sup>Notice: WAGO's 750-626 Filter Module is mandatory for marine approval (observe power supply instructions)!  
 ■ Approval is available. □ Approval is pending.

# Approvals Overview

## Digital Input Modules – I/O System 750/753

Versions with an extended temperature range (Item No. with Suffix /025-...) see the following pages

	cULus OrdLoc	E175199 Sec. 1, UL 508, UL 61010
	ABS (American Bureau of Shipping)	19-HG1821926-PDA; 18-HG1778162-PDA; 19-HG1821812-PDA
	BV (Bureau Veritas)	13453/D0 BV, 30389/B0 BV
	DNV (Det Norske Veritas) GL (Germanischer Lloyd)	TAA0000194; TAA00000Y7; TAA00001J4; TAA00001FS
	KR (Korean Register of Shipping)	HMB05880-AC001
	LR (Lloyd's Register)	02/20026 (E5); 17/20073 (E2)
	NK (Nippon Kaiji Kyokai)	TA17255M
	Polski Rejestr Statkow	TE/2210/880590/18; TE/2215/880590/18; TE/2214/880590/18
	RINA (Registro Italiano Navale)	ELE343217XG
	cULus HazLoc	E198726 Sec. 1, ANSI/ISA 12.12.01 E480271 Sec. 1, AEx UL60079
	INMETRO	TÜV 12.1297 X; TÜV 14.1911 X
	TÜV	07ATEX554086 X; IECEx TUN 09.0001 X 12ATEX106032 X; IECEx TUN 12.0039 X 14ATEX148929 X; IECEx TUN 14.0035 X 17ATEX193969 X; IECEx TUN 16.0046 X 17ATEX196484 X; IECEx TUN 17.0005 X DEKRA 11ATEX0203 X

Item No.	Item Description	ATEX/IECEX	BRA-Ex	HazLoc	RINA	PRS	NK	LR	KR	DNV GL	BV	ABS	OrdLoc	See Page
Digital Input Modules		Ex	Marine Approvals										UL	
750-400	2DI; 24 VDC; 3ms	■	■	■	■	■	■	■	■	■	■	■	■	165
750-401	2DI; 24 VDC; 0.2ms	■	■	■	■	■	■	■	■	■	■	■	■	171
750-402	4DI; 24 VDC; 3ms	■	■	■	■	■	■	■	■	■	■	■	■	166
750-403	4DI; 24 VDC; 0.2ms	■	■	■	■	■	■	■	■	■	■	■	■	171
750-405	2DI; 230 VAC	■	■	■	■	■	■	■	■	■	■	■	■	188
750-406	2DI; 120 VAC	■	■	■	■	■	■	■	■	■	■	■	■	188
750-407	2DI; 220 VDC	■	■	■	■	■	■	■	■	■	■	■	■	187
750-408	4DI; 24 VDC; 3ms; LSS	■	■	■	■	■	■	■	■	■	■	■	■	174
750-409	4DI; 24 VDC; 0.2ms; LSS	■	■	■	■	■	■	■	■	■	■	■	■	177
750-410	2DI; 24 VDC; 3ms; Proxi Sensor	■	■	■	■	■	■	■	■	■	■	■	■	179
750-411	2DI; 24 VDC; 0.2ms; Proxi Sensor	■	■	■	■	■	■	■	■	■	■	■	■	179
750-412	2DI; 48 VDC; 3ms	■	■	■	■	■	■	■	■	■	■	■	■	185
750-414	4DI; 5 VDC; 0.2ms	■	■	■	■	■	■	■	■	■	■	■	■	164
750-415	4DI; 24 VAC/VDC; 20ms	■	■	■	■	■	■	■	■	■	■	■	■	183
750-418	2DI; 24 VDC; 3ms; Acknol; Diagn	■	■	■	■	■	■	■	■	■	■	■	■	165
750-421	2DI; 24 VDC; 3ms; Diagn	■	■	■	■	■	■	■	■	■	■	■	■	166
750-422	4DI; 24 VDC; Pulse Extention	■	■	■	■	■	■	■	■	■	■	■	■	182
750-423	4DI; 24 VAC/VDC; 50ms	■	■	■	■	■	■	■	■	■	■	■	■	183
750-424	2DI; Intruder Detection	■	■	■	■	■	■	■	■	■	■	■	■	181
750-425	2DI; NAMUR	■	■	■	■	■	■	■	■	■	■	■	■	180
750-427	2DI; 110 VDC	■	■	■	■	■	■	■	■	■	■	■	■	187
750-428	4DI; 42 VAC/VDC; 20ms	■	■	■	■	■	■	■	■	■	■	■	■	184
750-430	8DI; 24 VDC; 3ms	■	■	■	■	■	■	■	■	■	■	■	■	168
750-431	8DI; 24 VDC; 0.2ms	■	■	■	■	■	■	■	■	■	■	■	■	173
750-432	4DI; 24 VDC; 3ms; 2-wire	■	■	■	■	■	■	■	■	■	■	■	■	167
750-433	4DI; 24 VDC; 0.2ms	■	■	■	■	■	■	■	■	■	■	■	■	172
750-435 <sup>2)</sup>	1DI; NAMUR; Ex i	■	■	■	■	■	■	■	■	■	■	■	■	311
750-436	8DI; 24 VDC; 3ms; LSS	■	■	■	■	■	■	■	■	■	■	■	■	175
750-437	8DI; 24 VDC; 0.2ms; LSS	■	■	■	■	■	■	■	■	■	■	■	■	178
750-438 <sup>2)</sup>	2DI; NAMUR; Ex i	■	■	■	■	■	■	■	■	■	■	■	■	311
750-439 <sup>2)</sup>	8DI; NAMUR; Ex i	■	■	■	■	■	■	■	■	■	■	■	■	312
750-1400	16DI; 24 VDC; 3ms; Ribbon Cable	■	■	■	■	■	■	■	■	■	■	■	■	169
750-1402	16DI; 24 VDC; 3ms; LSS; Ribbon Cable	■	■	■	■	■	■	■	■	■	■	■	■	176
750-1405	16DI; 24 VDC; 3ms	■	■	■	■	■	■	■	■	■	■	■	■	169
750-1406	16DI; 24 VDC; 0.2ms	■	■	■	■	■	■	■	■	■	■	■	■	173
750-1407	16DI; 24 VDC; 3ms; LSS	■	■	■	■	■	■	■	■	■	■	■	■	176
750-1415	8DI; 24 VDC; 3ms; 2-wire	■	■	■	■	■	■	■	■	■	■	■	■	168
750-1416	8DI; 24 VDC; 0.2ms; 2-wire	■	■	■	■	■	■	■	■	■	■	■	■	173
750-1417	8DI; 24 VDC; 3ms; LSS; 2-wire	■	■	■	■	■	■	■	■	■	■	■	■	175
750-1418	8DI; 24 VDC; 0.2ms; LSS; 2-wire	■	■	■	■	■	■	■	■	■	■	■	■	178
750-1420	4DI; 24 VDC; 3ms; 3-wire	■	■	■	■	■	■	■	■	■	■	■	■	167
750-1421	4DI; 24 VDC; 0.2ms; 3-wire	■	■	■	■	■	■	■	■	■	■	■	■	172
750-1422	4DI; 24 VDC; 3ms; LSS; 3-wire	■	■	■	■	■	■	■	■	■	■	■	■	174
750-1423	4DI; 24 VDC; 0.2ms; LSS; 3-wire	■	■	■	■	■	■	■	■	■	■	■	■	177
750-1425	8DI; PTC	■	■	■	■	■	■	■	■	■	■	■	■	190
753-429	2DI; 60 VDC; 3ms	■	■	■	■	■	■	■	■	■	■	■	■	186
753-434	8DI; 5/12 VDC; 0.2ms	■	■	■	■	■	■	■	■	■	■	■	■	164
753-440	4DI; 120/230 VAC	■	■	■	■	■	■	■	■	■	■	■	■	189

\*Approval also applies to WAGO's I/O module variant equipped with 753 Series Pluggable Connector.

<sup>2)</sup> This I/O module shall only be used in connection with the 24 VDC Ex i supply module (observe power supply instructions)!











■ Approval is available. □ Approval is pending.



# Approvals Overview

## Digital Output Modules – I/O System 750/753

Versions with an extended temperature range (Item No. with Suffix /025-...) see the following pages

	cULus OrdLoc	E175199 Sec. 1, UL 508, UL 61010
	ABS (American Bureau of Shipping)	19-HG1821926-PDA; 18-HG1778162-PDA; 19-HG1821812-PDA
	BV (Bureau Veritas)	13453/D0 BV, 30389/B0 BV
	DNV (Det Norske Veritas) GL (Germanischer Lloyd)	TAA0000194; TAA00000Y7; TAA00001J4; TAA00001FS
	KR (Korean Register of Shipping)	HMB05880-AC001
	LR (Lloyd's Register)	02/20026 (E5); 17/20073 (E2)
	NK (Nippon Kaiji Kyokai)	TA17255M
	Polski Rejestr Statkow	TE/2210/880590/18; TE/2215/880590/18; TE/2214/880590/18
	RINA (Registro Italiano Navale)	ELE343217XG
	cULus HazLoc	E198726 Sec. 1, ANSI/ISA 12.12.01 E480271 Sec. 1, AEx UL60079
	INMETRO	TÜV 12.1297 X; TÜV 14.1911 X
	TÜV	07ATEX554086 X; IECEx TUN 09.0001 X 12ATEX106032 X; IECEx TUN 12.0039 X 14ATEX148929 X; IECEx TUN 14.0035 X 17ATEX193969 X; IECEx TUN 16.0046 X 17ATEX196484 X; IECEx TUN 17.0005 X DEKRA 11ATEX0203 X

Item No.	Item Description	ATEX/IECEX	BRA-Ex	HazLoc	RINA	PRS	NK	LR	KR	DNV GL	BV	ABS	OrdLoc	See Page
Digital Output Modules		Ex	Marine Approvals										UL	
750-501	2DO; 24 VDC; 0.5A	■	■	■	■	■	■	■	■	■	■	■	■	195
750-502	2DO; 24 VDC; 2A	■	■	■	■	■	■	■	■	■	■	■	■	196
750-504	4DO; 24 VDC; 0.5A	■	■	■	■	■	■	■	■	■	■	■	■	198
750-506	2DO; 24 VDC; 0.5A; Diagn	■	■	■	■	■	■	■	■	■	■	■	■	197
750-508	2DO; 24 VDC; 2A; Diagn	■	■	■	■	■	■	■	■	■	■	■	■	197
750-509	2DO; 230 VAC; 0.3A; SSR	■	■	■	■	■	■	■	■	■	■	■	■	206
750-512	2RO; 250 VAC; 2A; Relay2NO	■	■	■	■	■	■	■	■	■	■	■	■	208
750-513	2RO; 250 VAC; 2A; Pot-free; Relay2NO	■	■	■	■	■	■	■	■	■	■	■	■	209
750-514	2RO; 125 VAC; 0.5A; Pot-free; Relay2CO	■	■	■	■	■	■	■	■	■	■	■	■	207
750-515	4RO; 250 VAC; 2A; Pot-free; Relay4NO	■	■	■	■	■	■	■	■	■	■	■	■	210
750-516	4DO; 24 VDC; 0.5A; LSS	■	■	■	■	■	■	■	■	■	■	■	■	200
750-517	2RO; 250 VAC; 1A; Pot-free; Relay2CO	■	■	■	■	■	■	■	■	■	■	■	■	208
750-519	4DO; 5 VDC; 20mA	■	■	■	■	■	■	■	■	■	■	■	■	194
750-523	1RO; 230 VAC; 16A; Pot-free; Relay1NO	■	■	■	■	■	■	■	■	■	■	■	■	211
750-530	8DO; 24 VDC; 0.5A	■	■	■	■	■	■	■	■	■	■	■	■	201
750-531	4DO; 24 VDC; 0.5A; 2-wire	■	■	■	■	■	■	■	■	■	■	■	■	199
750-532	4DO; 24 VDC; 0.5A; Diagn	■	■	■	■	■	■	■	■	■	■	■	■	200
750-534	8DO; 12 VDC; 1A	■	■	■	■	■	■	■	■	■	■	■	■	194
750-535 <sup>2)</sup>	2DO; 24 VDC; Ex i	■	■	■	■	■	■	■	■	■	■	■	■	314
750-536	8DO; 24 VDC; 0.5A; LSS	■	■	■	■	■	■	■	■	■	■	■	■	201
750-537	8DO; 24 VDC; 0.5A; Diagn	■	■	■	■	■	■	■	■	■	■	■	■	201
750-538 <sup>2)</sup>	2RO; 100 VAC/ 30 VDC; Pot-free; Relay2CO; Ex i	■	■	■	■	■	■	■	■	■	■	■	■	315
750-539 <sup>2)</sup>	4DO; 24 VDC; Valve; Ex i	■	■	■	■	■	■	■	■	■	■	■	■	314
750-1500	16DO; 24 VDC; 0.5A; Ribbon Cable	■	■	■	■	■	■	■	■	■	■	■	■	204
750-1501	16DO; 24 VDC; 0.5A; LSS; Ribbon Cable	■	■	■	■	■	■	■	■	■	■	■	■	205
750-1502	8DIO; 24 VDC; 0.5A; Ribbon Cable	■	■	■	■	■	■	■	■	■	■	■	■	203
750-1504	16DO; 24 VDC; 0.5A	■	■	■	■	■	■	■	■	■	■	■	■	204
750-1505	16DO; 24 VDC; 0.5A; LSS	■	■	■	■	■	■	■	■	■	■	■	■	205
750-1506	8DIO; 24 VDC; 0.5A	■	■	■	■	■	■	■	■	■	■	■	■	203
750-1515	8DO; 24 VDC; 0.5A; 2-wire	■	■	■	■	■	■	■	■	■	■	■	■	202
750-1516	8DO; 24 VDC; 0.5A; LSS; 2-wire	■	■	■	■	■	■	■	■	■	■	■	■	202
753-540	4DO; 230 VAC; 0.25A; SSR	■	■	■	■	■	■	■	■	■	■	■	■	206

\*Approval also applies to WAGO's I/O module variant equipped with 753 Series Pluggable Connector.

<sup>2)</sup>This I/O module shall only be used in connection with the 24 VDC Ex i supply module (observe power supply instructions)!

■ Approval is available. □ Approval is pending.

# Approvals Overview

## Analog Input Modules – I/O System 750/753

Versions with an extended temperature range (Item No. with Suffix /025-...) see the following pages

	cULus OrdLoc	E175199 Sec. 1, UL 508, UL 61010
	ABS (American Bureau of Shipping)	19-HG1821926-PDA; 18-HG1778162-PDA; 19-HG1821812-PDA
	BV (Bureau Veritas)	13453/D0 BV, 30389/B0 BV
	DNV (Det Norske Veritas) GL (Germanischer Lloyd)	TAA0000194; TAA00000Y7; TAA00001J4; TAA00001FS
	KR (Korean Register of Shipping)	HMB05880-AC001
	LR (Lloyd's Register)	02/20026 (E5); 17/20073 (E2)
	NK (Nippon Kaiji Kyokai)	TA17255M
	Polski Rejestr Statkow	TE/2210/880590/18; TE/2215/880590/18; TE/2214/880590/18
	RINA (Registro Italiano Navale)	ELE343217XG
	cULus HazLoc	E198726 Sec. 1, ANSI/ISA 12.12.01 E480271 Sec. 1, AEx UL60079
	INMETRO	TÜV 12.1297 X; TÜV 14.1911 X
	TÜV	07ATEX554086 X; IECEx TUN 09.0001 X 12ATEX106032 X; IECEx TUN 12.0039 X 14ATEX148929 X; IECEx TUN 14.0035 X 17ATEX193969 X; IECEx TUN 16.0046 X 17ATEX196484 X; IECEx TUN 17.0005 X DEKRA 11ATEX0203 X

Item No.	Item Description	ATEX/IECEX	BRA-Ex	HazLoc	RINA	PRS	NK	LR	KR	DNV GL	BV	ABS	OrdLoc	See Page
Analog Input Modules		Ex	Marine Approvals										UL	
750-450	4AI; RTD; Adjust	■												237
750-451	8AI; RTD; Adjust	■												237
750-452	2AI; 0-20mA; Diff	■	■	■	■	■	■	■	■	■	■	■	■	214
750-453	4AI; 0-20mA; SE	■	■	■	■	■	■	■	■	■	■	■	■	216
750-454	2AI; 4-20mA; Diff	■	■	■	■	■	■	■	■	■	■	■	■	217
750-455	4AI; 4-20mA; SE	■	■	■	■	■	■	■	■	■	■	■	■	224
750-456	2AI; ±10 VDC; Diff	■	■	■	■	■	■	■	■	■	■	■	■	227
750-457	4AI; ±10 VDC; SE	■	■	■	■	■	■	■	■	■	■	■	■	228
750-458	8AI; TC; Adjust	■												239
750-459	4AI; 0-10 VDC; SE	■	■	■	■	■	■	■	■	■	■	■	■	230
750-461	2AI; Pt100/RTD	■	■	■	■	■	■	■	■	■	■	■	■	234
750-463	4AI; RTD; -30°C...+150°C	■												237
750-464	2/4AI; RTD; Adjust	■	■	■	■	■	■	■	■	■	■	■	■	236
750-465	2AI; 0-20mA; SE	■	■	■	■	■	■	■	■	■	■	■	■	215
750-466	2AI; 4-20mA; SE	■	■	■	■	■	■	■	■	■	■	■	■	219
750-467	2AI; 0-10 VDC; SE	■	■	■	■	■	■	■	■	■	■	■	■	229
750-468	4AI; 0-10 VDC; SE	■	■	■	■	■	■	■	■	■	■	■	■	230
750-469	2AI; TC K; Diagn	■	■	■	■	■	■	■	■	■	■	■	■	238
750-470	2AI; 0-20mA; SE	■	■	■	■	■	■	■	■	■	■	■	■	215
750-471	4AI; U/I; Diff; Galv	■	■	■	■	■	■	■	■	■	■	■	■	233
750-472	2AI; 0-20mA; SE; 16bits	■	■	■	■	■	■	■	■	■	■	■	■	216
750-473	2AI; 4-20mA; SE	■	■	■	■	■	■	■	■	■	■	■	■	220
750-474	2AI; 4-20mA; SE; 16bits	■	■	■	■	■	■	■	■	■	■	■	■	221
750-475	2AI; 0-1A AC/DC; Diff	■	■	■	■	■	■	■	■	■	■	■	■	226
750-476	2AI; ±10 VDC; SE; 16bits	■	■	■	■	■	■	■	■	■	■	■	■	228
750-477	2AI; 0-10 VAC/VDC; Diff	■	■	■	■	■	■	■	■	■	■	■	■	232
750-478	2AI; 0-10 VDC; SE; 16bits	■	■	■	■	■	■	■	■	■	■	■	■	229
750-479	2AI; ±10 VDC; Diff	■	■	■	■	■	■	■	■	■	■	■	■	227
750-480	2AI; 0-20mA; Diff	■	■	■	■	■	■	■	■	■	■	■	■	214
750-481/003-000 <sup>2)</sup>	2AI; RTD; Ex i	■	■	■	■	■	■	■	■	■	■	■	■	318
750-482	2AI; 4-20mA HART	■	■	■	■	■	■	■	■	■	■	■	■	222
750-483	2AI; 0-30 VDC; Diff	■	■	■	■	■	■	■	■	■	■	■	■	232
750-484 <sup>2)</sup>	2AI; 4-20mA HART; Ex i	■	■	■	■	■	■	■	■	■	■	■	■	317
750-484/000-001 <sup>2)</sup>	2AI 4-20mA HART NAMUR NE43 Ex i	■	■	■	■	■	■	■	■	■	■	■	■	317
750-485 <sup>2)</sup>	4AI; 4-20mA; Ex i	■	■	■	■	■	■	■	■	■	■	■	■	316
750-486 <sup>2)</sup>	4AI; 0/4-20mA; NE43; Ex i	■	■	■	■	■	■	■	■	■	■	■	■	316
750-487/003-000 <sup>2)</sup>	2AI; TC; Ex i	■	■	■	■	■	■	■	■	■	■	■	■	318
750-491	1AI; DMS	■											□	240
750-492	2AI; 4-20mA; Diff	■	■	■	■	■	■	■	■	■	■	■	■	218
750-493	3-PHASE POM; 480VAC 1A	■	■	■	■	■	■	■	■	■	■	■	■	241
750-494	3-PHASE POM; 480VAC 1A	■	■	■	■	■	■	■	■	■	■	■	■	242
750-495	3-PHASE POM; 690VAC 1A	■	■	■	■	■	■	■	■	■	■	■	■	244
750-496	8AI; 0/4-20mA; SE	■	■	■	■	■	■	■	■	■	■	■	■	225
750-497	8AI; 0-10 V/±10 VDC; SE	■	■	■	■	■	■	■	■	■	■	■	■	231

\*Approval also applies to WAGO's I/O module variant equipped with 753 Series Pluggable Connector.

<sup>2)</sup>This I/O module shall only be used in connection with the 24 VDC Ex i supply module (observe power supply instructions)!

■ Approval is available. □ Approval is pending.



# Approvals Overview

## Function, Technology and Communication Modules – I/O System 750/753

Versions with an extended temperature range (Item No. with Suffix /025-...) see the following pages

	cULus OrdLoc	E175199 Sec. 1, UL 508, UL 61010
	ABS (American Bureau of Shipping)	19-HG1821926-PDA; 18-HG1778162-PDA; 19-HG1821812-PDA
	BV (Bureau Veritas)	13453/D0 BV, 30389/B0 BV
	DNV (Det Norske Veritas) GL (Germanischer Lloyd)	TAA0000194; TAA00000Y7; TAA00001J4; TAA00001FS
	KR (Korean Register of Shipping)	HMB05880-AC001
	LR (Lloyd's Register)	02/20026 (E5); 17/20073 (E2)
	NK (Nippon Kaiji Kyokai)	TA17255M
	Polski Rejestr Statkow	TE/2210/880590/18; TE/2215/880590/18; TE/2214/880590/18
	RINA (Registro Italiano Navale)	ELE343217XG
	cULus HazLoc	E198726 Sec. 1, ANSI/ISA 12.12.01 E480271 Sec. 1, AEx UL60079
	INMETRO	TÜV 12.1297 X; TÜV 14.1911 X
	TÜV	07ATEX554086 X; IECEx TUN 09.0001 X 12ATEX106032 X; IECEx TUN 12.0039 X 14ATEX148929 X; IECEx TUN 14.0035 X 17ATEX193969 X; IECEx TUN 16.0046 X 17ATEX196484 X; IECEx TUN 17.0005 X DEKRA 11ATEX0203 X

Item No.	Item Description	ATEX/IECEX	BRA-Ex	HazLoc	RINA	PRS	NK	LR	KR	DNV GL	BV	ABS	OrdLoc	See Page
Function, Technology and Communication Modules		Ex	Marine Approvals										UL	
750-404	Up/Down Counter	■	■	■	■	■	■	■	■	■	■	■	■	258
750-511	2PWM; 24 VDC; 0.1A; 250Hz	■	■	■	■	■	■	■	■	■	■	■	■	261
750-630	SSI Interface; 24bits; 125kHz; Gray	■	■	■	■	■	■	■	■	■	■	■	■	262
750-631/000-004	Inc. Encoder; RS422; 16bits	■	■	■	■	■	■	■	■	■	■	■	■	264
750-632	Proportional Valve Module	■	■	■	■	■	■	■	■	■	■	■	■	274
750-633 <sup>2)</sup>	Up/Down Counter; Ex i	■	■	■	■	■	■	■	■	■	■	■	■	320
750-635	Digital impulse interface	■	■	■	■	■	■	■	■	■	■	■	■	266
750-637	Inc. Encoder; RS422; 32bits	■	■	■	■	■	■	■	■	■	■	■	■	264
750-638	2Up/Down Counter; 16bits; 500Hz	■	■	■	■	■	■	■	■	■	■	■	■	260
750-640	RTC Module	■	■	■	■	■	■	■	■	■	■	■	■	267
750-642	Radio Receiver EnOcean	■	■	■	■	■	■	■	■	■	■	■	■	284
750-643	MP-Bus Master	■	■	■	■	■	■	■	■	■	■	■	■	288
750-645	2VIB VRMS/SPM Multi	■	■	■	■	■	■	■	■	■	■	■	■	268
750-650	RS232 C Interface; 9600Bd	■	■	■	■	■	■	■	■	■	■	■	■	278
750-651	TTY Interface; 9600Bd; N; 8/1	■	■	■	■	■	■	■	■	■	■	■	■	283
750-652	RS232/485 Interface	■	■	■	■	■	■	■	■	■	■	■	■	282
750-653	RS485 Interface	■	■	■	■	■	■	■	■	■	■	■	■	280
750-654	Data Exchange Interface	■	■	■	■	■	■	■	■	■	■	■	■	294
750-655	AS-Interface Master	■	■	■	■	■	■	■	■	■	■	■	■	291
750-657	IO-Link Master	■	■	■	■	■	■	■	■	■	■	■	■	292
750-658	CAN Gateway	■	■	■	■	■	■	■	■	■	■	■	■	293
750-660/000-001	8FDI; 24 VDC; PROFIsafe	■	■	■	■	■	■	■	■	■	■	■	■	300
750-661/000-003	4FDI; 24 VDC; PROFIsafe V2 iPar	■	■	■	■	■	■	■	■	■	■	■	■	301
750-662/000-003	8FDI; 24 VDC; PROFIsafe V2 iPar	■	■	■	■	■	■	■	■	■	■	■	■	301
750-663/000-003	4F-Ex i DI; 24 VDC; PROFIsafe V2 iPar	■	■	■	■	■	■	■	■	■	■	■	■	305
750-665/000-001	4FDI/4FDO; 24 VDC; 0.5A; PROFIsafe	■	■	■	■	■	■	■	■	■	■	■	■	300
750-666/000-003	4FDI/2FDO; 24 VDC; 10A; PROFIsafe V2 iPar	■	■	■	■	■	■	■	■	■	■	■	■	302
750-667/000-003	4FDI/4FDO; 24 VDC; 2A; PROFIsafe V2 iPar	■	■	■	■	■	■	■	■	■	■	■	■	303
750-670	Stepper Controller; RS422/24 VDC; 20mA	■	■	■	■	■	■	■	■	■	■	■	■	269
750-671	Stepper Controller; 24 VDC; 1.5A	■	■	■	■	■	■	■	■	■	■	■	■	270
753-646	KNX/EIB/TP1 Interface	■	■	■	■	■	■	■	■	■	■	■	■	285
753-647	DALI Multi-Master	■	■	■	■	■	■	■	■	■	■	■	■	286
753-648	LON® FTT Interface	■	■	■	■	■	■	■	■	■	■	■	■	287

\*Approval also applies to WAGO's I/O module variant equipped with 753 Series Pluggable Connector.











<sup>2)</sup>This I/O module shall only be used in connection with the 24 VDC Ex i supply module (observe power supply instructions)!

■ Approval is available. □ Approval is pending.

# Approvals Overview

## Supply and Segment Modules – I/O System 750/753

Versions with an extended temperature range (Item No. with Suffix /025-...) see the following pages

	cULus OrdLoc	E175199 Sec. 1, UL 508, UL 61010
	ABS (American Bureau of Shipping)	19-HG1821926-PDA; 18-HG1778162-PDA; 19-HG1821812-PDA
	BV (Bureau Veritas)	13453/D0 BV, 30389/B0 BV
	DNV (Det Norske Veritas) GL (Germanischer Lloyd)	TAA0000194; TAA00000Y7; TAA00001J4; TAA00001FS
	KR (Korean Register of Shipping)	HMB05880-AC001
	LR (Lloyd's Register)	02/20026 (E5); 17/20073 (E2)
	NK (Nippon Kaiji Kyokai)	TA17255M
	Polski Rejestr Statkow	TE/2210/880590/18; TE/2215/880590/18; TE/2214/880590/18
	RINA (Registro Italiano Navale)	ELE343217XG
	cULus HazLoc	E198726 Sec. 1, ANSI/ISA 12.12.01 E480271 Sec. 1, AEx UL60079
	INMETRO	TÜV 12.1297 X; TÜV 14.1911 X
	TÜV	07ATEX554086 X; IECEx TUN 09.0001 X 12ATEX106032 X; IECEx TUN 12.0039 X 14ATEX148929 X; IECEx TUN 14.0035 X 17ATEX193969 X; IECEx TUN 16.0046 X 17ATEX196484 X; IECEx TUN 17.0005 X DEKRA 11ATEX0203 X

Item No.	Item Description	ATEX/IECEX	BRA-Ex	HazLoc	RINA	PRS	NK	LR	KR	DNV GL	BV	ABS	OrdLoc	See Page
Supply and Segment Modules		Ex	Marine Approvals										UL	
750-600	End Module	■	■	■	■	■	■	■	■	■	■	■	■	342
750-601 <sup>3)</sup>	Power Supply; 24 VDC; Fuse	■	■	■	■	■	■	■	■	■	■	■	■	325
750-602 <sup>3)</sup>	Power Supply; 24 VDC	■	■	■	■	■	■	■	■	■	■	■	■	324
750-603	Potential Distribution; 8*24V	■	■	■	■	■	■	■	■	■	■	■	■	332
750-604	Potential Distribution; 8*0V	■	■	■	■	■	■	■	■	■	■	■	■	332
750-606	Power Supply; 24 VDC; Diagn; Ex i	■	■	■	■	■	■	■	■	■	■	■	■	310
750-609	Power Supply; 230 VAC; Fuse	■	■	■	■	■	■	■	■	■	■	■	■	329
750-610 <sup>3)</sup>	Power Supply; 24 VDC; Fuse; Diagn	■	■	■	■	■	■	■	■	■	■	■	■	325
750-611	Power Supply; 230 VAC; Fuse; Diagn	■	■	■	■	■	■	■	■	■	■	■	■	329
750-612 <sup>4)</sup>	Power Supply; 0-230 VAC/VDC	■	■	■	■	■	■	■	■	■	■	■	■	327
750-613 <sup>1)</sup>	System Power Supply; 24 VDC	■	■	■	■	■	■	■	■	■	■	■	■	326
750-614	Potential Distribution	■	■	■	■	■	■	■	■	■	■	■	■	331
750-615	Power Supply; 120 VAC; Fuse	■	■	■	■	■	■	■	■	■	■	■	■	328
750-616	Distance Module	■	■	■	■	■	■	■	■	■	■	■	■	341
750-617	Power Supply; 24 VAC; Fuse	■	■	■	■	■	■	■	■	■	■	■	■	328
750-621	Distance Module	■	■	■	■	■	■	■	■	■	■	■	■	341
750-622	Binary Spacer Module	■	■	■	■	■	■	■	■	■	■	■	■	339
750-623	Power Supply; 24/5-15 VDC	■	■	■	■	■	■	■	■	■	■	■	■	324
750-624	Field Supply Filter; 24 VDC	■	■	■	■	■	■	■	■	■	■	■	■	334
750-625/000-001	Power Supply; 24 VDC; Ex i	■	■	■	■	■	■	■	■	■	■	■	■	310
750-626	Supply Filter; 24 VDC	■	■	■	■	■	■	■	■	■	■	■	■	336
750-627	Bus Extension End Module	■	■	■	■	■	■	■	■	□	■	■	■	338
750-628	Bus Extension Coupler Module	■	■	■	■	■	■	■	■	□	■	■	■	338
750-1605	Potential Distribution; 16*24V	■	■	■	■	■	■	■	■	■	■	■	■	333
750-1606	Potential Distribution; 16*0V	■	■	■	■	■	■	■	■	■	■	■	■	333
750-1607	Potential Distribution; 8*24V/8*0V	■	■	■	■	■	■	■	■	■	■	■	■	333
753-620	DALI Multi-Master DC/DC-Converter	■	■	■	■	■	■	■	■	■	■	■	■	330
753-629/020-000	Spacer Module; Passive	■	■	■	■	■	■	■	■	■	■	■	■	340
753-1629	Spacer Module; Active	■	■	■	■	■	■	■	■	■	■	■	■	340

\*Approval also applies to WAGO's I/O module variant equipped with 753 Series Pluggable Connector.

<sup>1)</sup> Notice: WAGO's 750-626 Filter Module is mandatory for marine approval (observe power supply instructions)!

<sup>3)</sup> Notice: WAGO's 750-624 Filter Module is mandatory for marine approval (observe power supply instructions)!

<sup>4)</sup> Notice: WAGO's 750-626 Filter Module is mandatory for marine approval at 24 VDC power supply (observe power supply instructions)!

■ Approval is available. □ Approval is pending.

# Approvals Overview

## I/O System 750; Versions with an extended temperature range

Surrounding air temperature (operation): -20 ... +60 °C

	cULus OrdLoc	E175199 Sec. 1, UL 508, UL 61010
	ABS (American Bureau of Shipping)	19-HG1821926-PDA; 18-HG1778162-PDA; 19-HG1821812-PDA
	BV (Bureau Veritas)	13453/D0 BV, 30389/B0 BV
	DNV (Det Norske Veritas) GL (Germanischer Lloyd)	TAA0000194; TAA00000Y7; TAA00001J4; TAA00001FS
	KR (Korean Register of Shipping)	HMB05880-AC001
	LR (Lloyd's Register)	02/20026 (E5); 17/20073 (E2)
	NK (Nippon Kaiji Kyokai)	TA17255M
	Polski Rejestr Statkow	TE/2210/880590/18; TE/2215/880590/18; TE/2214/880590/18
	RINA (Registro Italiano Navale)	ELE343217XG
	cULus HazLoc	E198726 Sec. 1, ANSI/ISA 12.12.01 E480271 Sec. 1, AEx UL60079
	INMETRO	TÜV 12.1297 X; TÜV 14.1911 X
	TÜV	07ATEX554086 X; IECEx TUN 09.0001 X 12ATEX106032 X; IECEx TUN 12.0039 X 14ATEX148929 X; IECEx TUN 14.0035 X 17ATEX193969 X; IECEx TUN 16.0046 X 17ATEX196484 X; IECEx TUN 17.0005 X DEKRA 11ATEX0203 X

Item No.	Item Description	ATEX/IECEx	BRA-Ex	HazLoc	RINA	PRS	NK	LR	KR	DNV GL	BV	ABS	OrdLoc	See Page	
<b>Controllers PFC100/PFC200 <sup>1)</sup></b>		<b>Ex</b>												<b>UL</b>	
750-8101/025-000	PFC100; 2ETH; T	■		■									■	79	
750-8102/025-000	PFC100; 2ETH RS; T	■		■									■	79	
750-8207/025-000	PFC200; 2ETH RS 3G	■											□	85	
750-8207/025-001	PFC200; 2ETH RS 3G	■											□	85	
750-8208/025-000	PFC200; 2ETH RS CAN DPM	■				■							■	86	
750-8208/025-001	PFC200; 2ETH RS CAN DPM	■				■							■	86	
750-8212/025-000	PFC200; G2; 2ETH RS; T	■		■									■	80	
750-8212/025-001	PFC200; G2; 2ETH RS; Tele; T	■		■									■	80	
750-8212/025-002	PFC200; G2; 2ETH RS; Tele; T; Eco	■		■									■	80	
750-8216/025-000	PFC200; G2; 2ETH RS CAN DPS; T	■		■									■	84	
750-8216/025-001	PFC200; G2; 2ETH RS CAN DPS; Tele; T	■		■									■	84	
<b>Controllers 750 <sup>1)</sup></b>															
750-815/325-000	Controller Modbus®; RS485; 115.2kBd; T	■		■	■	■	■	■	■	■	■	■	■	117	
750-833/025-000	Controller PROFIBUS Slave; T	■	■	■	■	■	■	■	■	■	■	■	■	118	
750-880/025-000	Controller ETHERNET; G3; SD; T	■	■	■	■	■	■	■	■	■	■	■	■	108	
750-880/025-001	Controller ETHERNET; G3; SD; Tele; T	■	■	■	■	■	■	■	■	■	■	■	■	108	
750-880/025-002	Controller ETHERNET; G3; SD; Tele; T; Eco	■	■	■	■	■	■	■	■	■	■	■	■	108	
750-885/025-000	Controller ETHERNET; G3; SD; MR; T	■	■	■	■	■	■	■	■	■	■	■	■	110	
<b>Fieldbus Couplers</b>															
750-333/025-000	FC PROFIBUS; G2; 12MBd; T	■	■	■	■	■	■	■	■	■	■	■	■	149	
750-337/025-000	FC CANopen; MCS; T	■	■	■	■	■	■	■	■	■	■	■	■	156	
750-375/025-000	FC PROFINET; G3; Adv; T	■	■	■	■	■	■	■	■	■	■	■	■	148	
750-377/025-000	FC PROFINET; G3; Eco; Adv; T	■	■	■	■	■	■	■	■	■	■	■	■	148	
<b>Digital Input Modules</b>															
750-400/025-000	2DI; 24 VDC; 3ms; T	■	■	■	■	■	■	■	■	■	■	■	■	165	
750-402/025-000	4DI; 24 VDC; 3ms; T	■	■	■	■	■	■	■	■	■	■	■	■	166	
750-408/025-000	4DI; 24 VDC; 3ms; LSS; T	■	■	■	■	■	■	■	■	■	■	■	■	174	
750-430/025-000	8DI; 24 VDC; 3ms; T	■	■	■	■	■	■	■	■	■	■	■	■	168	
<b>Digital Output Modules</b>															
750-504/025-000	4DO; 24 VDC; 0.5A; T	■	■	■	■	■	■	■	■	■	■	■	■	198	
750-504/025-800	4DO; 24 VDC; 0.5A; IF; T	■	■	■	■	■	■	■	■	■	■	■	■	198	
750-530/025-000	8DO; 24 VDC; 0.5A; T	■	■	■	■	■	■	■	■	■	■	■	■	201	

<sup>1)</sup> Notice: WAGO's 750-626/... Filter Module is mandatory for marine approval (observe power supply instructions)!

■ Approval is available. □ Approval is pending.

# Approvals Overview

## I/O System 750; Versions with an extended temperature range











Surrounding air temperature (operation): -20 ... +60 °C

Item No.	Item Description	ATEX/IECEX	BRA-Ex	HazLoc	RINA	PRS	NK	LR	KR	DNV GL	BV	ABS	OrdLoc	See Page																																																																																																																																																																						
<table border="1"> <tr> <td></td> <td>cULus OrdLoc</td> <td colspan="12">E175199 Sec. 1, UL 508, UL 61010</td> </tr> <tr> <td></td> <td>ABS (American Bureau of Shipping)</td> <td colspan="12">19-HG1821926-PDA; 18-HG1778162-PDA; 19-HG1821812-PDA</td> </tr> <tr> <td></td> <td>BV (Bureau Veritas)</td> <td colspan="12">13453/D0 BV, 30389/B0 BV</td> </tr> <tr> <td></td> <td>DNV (Det Norske Veritas) GL (Germanischer Lloyd)</td> <td colspan="12">TAA0000194; TAA00000Y7; TAA00001J4; TAA00001FS</td> </tr> <tr> <td></td> <td>KR (Korean Register of Shipping)</td> <td colspan="12">HMB05880-AC001</td> </tr> <tr> <td></td> <td>LR (Lloyd's Register)</td> <td colspan="12">02/20026 (E5); 17/20073 (E2)</td> </tr> <tr> <td></td> <td>NK (Nippon Kaiji Kyokai)</td> <td colspan="12">TA17255M</td> </tr> <tr> <td></td> <td>Polski Rejestr Statkow</td> <td colspan="12">TE/2210/880590/18; TE/2215/880590/18; TE/2214/880590/18</td> </tr> <tr> <td></td> <td>RINA (Registro Italiano Navale)</td> <td colspan="12">ELE343217XG</td> </tr> <tr> <td rowspan="3"></td> <td>cULus HazLoc</td> <td colspan="12">E198726 Sec. 1, ANSI/ISA 12.12.01 E480271 Sec. 1, AEx UL60079</td> </tr> <tr> <td>INMETRO</td> <td colspan="12">TÜV 12.1297 X; TÜV 14.1911 X</td> </tr> <tr> <td>TÜV</td> <td colspan="12">07ATEX554086 X; IECEx TUN 09.0001 X 12ATEX106032 X; IECEx TUN 12.0039 X 14ATEX148929 X; IECEx TUN 14.0035 X 17ATEX193969 X; IECEx TUN 16.0046 X 17ATEX196484 X; IECEx TUN 17.0005 X DEKRA 11ATEX0203 X</td> </tr> </table>			cULus OrdLoc	E175199 Sec. 1, UL 508, UL 61010													ABS (American Bureau of Shipping)	19-HG1821926-PDA; 18-HG1778162-PDA; 19-HG1821812-PDA													BV (Bureau Veritas)	13453/D0 BV, 30389/B0 BV													DNV (Det Norske Veritas) GL (Germanischer Lloyd)	TAA0000194; TAA00000Y7; TAA00001J4; TAA00001FS													KR (Korean Register of Shipping)	HMB05880-AC001													LR (Lloyd's Register)	02/20026 (E5); 17/20073 (E2)													NK (Nippon Kaiji Kyokai)	TA17255M													Polski Rejestr Statkow	TE/2210/880590/18; TE/2215/880590/18; TE/2214/880590/18													RINA (Registro Italiano Navale)	ELE343217XG													cULus HazLoc	E198726 Sec. 1, ANSI/ISA 12.12.01 E480271 Sec. 1, AEx UL60079												INMETRO	TÜV 12.1297 X; TÜV 14.1911 X												TÜV	07ATEX554086 X; IECEx TUN 09.0001 X 12ATEX106032 X; IECEx TUN 12.0039 X 14ATEX148929 X; IECEx TUN 14.0035 X 17ATEX193969 X; IECEx TUN 16.0046 X 17ATEX196484 X; IECEx TUN 17.0005 X DEKRA 11ATEX0203 X																								
	cULus OrdLoc	E175199 Sec. 1, UL 508, UL 61010																																																																																																																																																																																		
	ABS (American Bureau of Shipping)	19-HG1821926-PDA; 18-HG1778162-PDA; 19-HG1821812-PDA																																																																																																																																																																																		
	BV (Bureau Veritas)	13453/D0 BV, 30389/B0 BV																																																																																																																																																																																		
	DNV (Det Norske Veritas) GL (Germanischer Lloyd)	TAA0000194; TAA00000Y7; TAA00001J4; TAA00001FS																																																																																																																																																																																		
	KR (Korean Register of Shipping)	HMB05880-AC001																																																																																																																																																																																		
	LR (Lloyd's Register)	02/20026 (E5); 17/20073 (E2)																																																																																																																																																																																		
	NK (Nippon Kaiji Kyokai)	TA17255M																																																																																																																																																																																		
	Polski Rejestr Statkow	TE/2210/880590/18; TE/2215/880590/18; TE/2214/880590/18																																																																																																																																																																																		
	RINA (Registro Italiano Navale)	ELE343217XG																																																																																																																																																																																		
	cULus HazLoc	E198726 Sec. 1, ANSI/ISA 12.12.01 E480271 Sec. 1, AEx UL60079																																																																																																																																																																																		
	INMETRO	TÜV 12.1297 X; TÜV 14.1911 X																																																																																																																																																																																		
	TÜV	07ATEX554086 X; IECEx TUN 09.0001 X 12ATEX106032 X; IECEx TUN 12.0039 X 14ATEX148929 X; IECEx TUN 14.0035 X 17ATEX193969 X; IECEx TUN 16.0046 X 17ATEX196484 X; IECEx TUN 17.0005 X DEKRA 11ATEX0203 X																																																																																																																																																																																		
<b>Analog Input Modules</b>		<b>Ex</b>	<b>Marine Approvals</b>									<b>UL</b>																																																																																																																																																																								
750-451/025-000	8AI; RTD; Adjust; T	■	■	■	■	■	■	■	■	■	■	■	■	237																																																																																																																																																																						
750-454/025-000	2AI; 4-20mA; Diff; T	■	■	■	■	■	■	■	■	■	■	■	■	217																																																																																																																																																																						
750-454/025-003	2AI; 4-20mA; Diff; T; EM	■	■	■	■	■	■	■	■	■	■	■	■	217																																																																																																																																																																						
750-455/025-000	4AI; 4-20mA; SE; T	■	■	■	■	■	■	■	■	■	■	■	■	224																																																																																																																																																																						
750-457/025-000	4AI; ±10 VDC; SE; T	■	■	■	■	■	■	■	■	■	■	■	■	228																																																																																																																																																																						
750-461/025-000	2AI; Pt100/RTD; T	■	■	■	■	■	■	■	■	■	■	■	■	234																																																																																																																																																																						
750-465/025-000	2AI; 0-20mA; SE; T	■	■	■	■	■	■	■	■	■	■	■	■	215																																																																																																																																																																						
750-466/025-000	2AI; 4-20mA; SE; T	■	■	■	■	■	■	■	■	■	■	■	■	219																																																																																																																																																																						
750-468/025-000	4AI; 0-10 VDC; SE; T	■	■	■	■	■	■	■	■	■	■	■	■	230																																																																																																																																																																						
750-482/025-000	2AI; 4-20mA HART; T	■	■	■	■	■	■	■	■	■	■	■	■	222																																																																																																																																																																						
750-493/025-000	3-PHASE POM; 480VAC 1A; T	■	■	■	■	■	■	■	■	■	■	■	■	241																																																																																																																																																																						
750-494/025-000	3-PHASE POM; 480VAC 1A; T	■	■	■	■	■	■	■	■	■	■	■	■	242																																																																																																																																																																						
750-494/025-001	3-PHASE POM; 480VAC 5A; T	■	■	■	■	■	■	■	■	■	■	■	■	242																																																																																																																																																																						
<b>Analog Output Modules</b>																																																																																																																																																																																				
750-552/025-000	2AO; 0-20mA; T	■	■	■	■	■	■	■	■	■	■	■	■	248																																																																																																																																																																						
750-554/025-000	2AO; 4-20mA; T	■	■	■	■	■	■	■	■	■	■	■	■	250																																																																																																																																																																						
750-559/025-000	4AO; 0-10 VDC; T	■	■	■	■	■	■	■	■	■	■	■	■	253																																																																																																																																																																						
<b>Function/Technology and Communication Modules</b>																																																																																																																																																																																				
750-638/025-000	2Up/Down Counter; 16bits; 500Hz; T	■	■	■	■	■	■	■	■	■	■	■	■	260																																																																																																																																																																						
750-652/025-000	RS232/485 Interface; T	■	■	■	■	■	■	■	■	■	■	■	■	282																																																																																																																																																																						
750-653/025-000	RS485 Interface; T	■	■	■	■	■	■	■	■	■	■	■	■	280																																																																																																																																																																						
750-653/025-018	RS485 Interface; 9600Bd; N; 8/1	■	■	■	■	■	■	■	■	■	■	■	■	280																																																																																																																																																																						
<b>Supply and Segment Modules</b>																																																																																																																																																																																				
750-600/025-000	End Module; T	■	■	■	■	■	■	■	■	■	■	■	■	342																																																																																																																																																																						
750-602/025-000 <sup>3)</sup>	Power Supply; 24 VDC; T	■	■	■	■	■	■	■	■	■	■	■	■	324																																																																																																																																																																						
750-626/025-000	Supply Filter; 24 VDC; T	■	■	■	■	■	■	■	■	■	■	■	■	336																																																																																																																																																																						
750-626/025-001	Supply Filter; 24 VDC; HI; T	■	■	■	■	■	■	■	■	■	■	■	■	336																																																																																																																																																																						

<sup>3)</sup> Notice: WAGO's 750-624 Filter Module is mandatory for marine approval (observe power supply instructions!)  
 ■ Approval is available. □ Approval is pending.

# Approvals Overview I/O System 750 XTR

Surrounding air temperature (operation): -40 ... +70 °C

	cULus OrdLoc	E175199 Sec. 1, UL 508, UL 61010
	ABS (American Bureau of Shipping)	19-HG1821926-PDA; 18-HG1778162-PDA; 19-HG1821812-PDA
	BV (Bureau Veritas)	13453/D0 BV, 30389/B0 BV
	DNV (Det Norske Veritas) GL (Germanischer Lloyd)	TAA0000194; TAA00000Y7; TAA00001J4; TAA00001FS
	KR (Korean Register of Shipping)	HMB05880-AC001
	LR (Lloyd's Register)	02/20026 (E5); 17/20073 (E2)
	NK (Nippon Kaiji Kyokai)	TA17255M
	Polski Rejestr Statkow	TE/2210/880590/18; TE/2215/880590/18; TE/2214/880590/18
	RINA (Registro Italiano Navale)	ELE343217XG
	cULus HazLoc	E198726 Sec. 1, ANSI/ISA 12.12.01 E480271 Sec. 1, AEx UL60079
	INMETRO	TÜV 12.1297 X; TÜV 14.1911 X
	TÜV	07ATEX554086 X; IECEX TUN 09.0001 X 12ATEX106032 X; IECEX TUN 12.0039 X 14ATEX148929 X; IECEX TUN 14.0035 X 17ATEX193969 X; IECEX TUN 16.0046 X 17ATEX196484 X; IECEX TUN 17.0005 X DEKRA 11ATEX0203 X

Item No.	Item Description	ATEX/IECEX	BRA-Ex	HazLoc	RINA	PRS	NK	LR	KR	DNV GL	BV	ABS	OrdLoc	See Page	
<b>Fieldbus Couplers – I/O System 750 XTR <sup>1)</sup></b>		<b>Ex</b>		<b>Marine Approvals</b>										<b>UL</b>	
750-333/040-000	FC PROFIBUS; G2; 12 MBd; XTR	■	■	■	■	■	■	■	■	■	■	■	■	352	
750-338/040-000	FC CANopen; DSub; XTR	■	■	■	■	■	■	■	■	■	■	■	■	354	
750-352/040-000	FC ETHERNET; G3; XTR	■	■	■	■	■	■	■	■	■	■	■	■	353	
<b>Digital Input Modules XTR</b>															
750-407/040-000	2DI; 220 VDC; XTR	■	■	■	■	■	■	■	■	■	■	■	■	359	
750-427/040-000	2DI; 110 VDC; XTR	■	■	■	■	■	■	■	■	■	■	■	■	358	
750-429/040-001	2DI; 60 VDC; 3ms; XTR	■	■	■	■	■	■	■	■	■	■	■	■	358	
750-430/040-000	8DI; 24 VDC; 3ms; XTR	■	■	■	■	■	■	■	■	■	■	■	■	355	
750-431/040-000	8DI; 24 VDC; 0.2ms; XTR	■	■	■	■	■	■	■	■	■	■	■	■	357	
750-439/040-000 <sup>2)</sup>	8DI; NAMUR; Ex i; XTR	■	■	■	■	■	■	■	■	■	■	■	■	386	
750-1405/040-000	16DI; 24 VDC; 3ms; XTR	■	■	■	■	■	■	■	■	■	■	■	■	356	
750-1415/040-000	8DI; 24 VDC; 3ms; 2-wire; XTR	■	■	■	■	■	■	■	■	■	■	■	■	355	
750-1416/040-000	8DI; 24 VDC; 0.2ms; 2-wire; XTR	■	■	■	■	■	■	■	■	■	■	■	■	357	
<b>Digital Output Modules XTR</b>															
750-508/040-000	2DO; 24 VDC; 2A; Diagn; XTR	■	■	■	■	■	■	■	■	■	■	■	■	360	
750-517/040-000	2RO; 250 VAC; 1A; Relay2CO; XTR	■	■	■	■	■	■	■	■	■	■	■	■	362	
750-535/040-000 <sup>2)</sup>	2DO; 24 VDC; Ex i; XTR	■	■	■	■	■	■	■	■	■	■	■	■	387	
750-537/040-000	8DO; 24 VDC; 0.5A; Diagn; XTR	■	■	■	■	■	■	■	■	■	■	■	■	360	
750-1515/040-000	8DO; 24 VDC; 0.5A; 2-wire; XTR	■	■	■	■	■	■	■	■	■	■	■	■	361	
<b>Analog Input Modules XTR</b>															
750-453/040-000	4AI; 0-20mA; SE; XTR	■	■	■	■	■	■	■	■	■	■	■	■	363	
750-455/040-000	4AI; 4-20mA; SE; XTR	■	■	■	■	■	■	■	■	■	■	■	■	363	
750-457/040-000	4AI; ±10 VDC; SE; XTR	■	■	■	■	■	■	■	■	■	■	■	■	365	
750-464/040-000	2/4AI; RTD; Adjust; XTR	■	■	■	■	■	■	■	■	■	■	■	■	367	
750-468/040-000	4AI; 0-10 VDC; SE; XTR	■	■	■	■	■	■	■	■	■	■	■	■	365	
750-469/040-000	2AI; TC; Adjust; XTR	■	■	■	■	■	■	■	■	■	■	■	■	367	
750-481/040-000 <sup>2)</sup>	2AI; RTD; Ex i; XTR	■	■	■	■	■	■	■	■	■	■	■	■	390	
750-483/040-000	2AI; 0-30 VDC; Diff; XTR	■	■	■	■	■	■	■	■	■	■	■	■	368	
750-484/040-000 <sup>2)</sup>	2AI; 4-20mA HART; Ex i; XTR	■	■	■	■	■	■	■	■	■	■	■	■	389	
750-486/040-000 <sup>2)</sup>	4AI; 0/4-20mA; Ex i; XTR	■	■	■	■	■	■	■	■	■	■	■	■	388	
750-492/040-001	2AI; 4-20mA; Diff; NE43; XTR	■	■	■	■	■	■	■	■	■	■	■	■	364	
750-495/040-000	3-PHASE POM; 690VAC 1A; XTR	■	■	■	■	■	■	■	■	■	■	■	■	368	
750-495/040-001	3-PHASE POM; 690VAC 5A; XTR	■	■	■	■	■	■	■	■	■	■	■	■	368	
750-495/040-002	3-PHASE POM; 690VAC R.C.; XTR	■	■	■	■	■	■	■	■	■	■	■	■	368	
<b>Analog Output Modules XTR</b>															
750-557/040-000	4AO; ±10V DC; XTR	■	■	■	■	■	■	■	■	■	■	■	■	370	
750-559/040-000	4AO; 0-10V DC; XTR	■	■	■	■	■	■	■	■	■	■	■	■	370	
750-563/040-000	2AO; 0/4-20mA; 16Bit; 6-18 VDC; XTR	■	■	■	■	■	■	■	■	■	■	■	■	369	
750-585/040-000 <sup>2)</sup>	2AO; 0-20mA; Ex i; XTR	■	■	■	■	■	■	■	■	■	■	■	■	391	

<sup>1)</sup> Notice: WAGO's 750-626/040-000 Filter Module is mandatory for marine approval (observe power supply instructions)!

<sup>2)</sup> This I/O module shall only be used in connection with the 24 VDC Ex i XTR supply module (observe power supply instructions)!

■ Approval is available. □ Approval is pending.



# Approvals Overview I/O System 750 XTR

Surrounding air temperature (operation): -40 ... +70 °C

Item No.	Item Description	ATEX/IECEX	BRA-Ex	HazLoc	RINA	PRS	NK	LR	KR	DNV GL	BV	ABS	OrdLoc	See Page
<b>Function/Technology Modules XTR</b>														
750-404/040-003	Counter; Adjust; XTR	■	■	■	■	■	■	■	■	■	■	■	■	371
750-630/040-001	SSI Interface; Adjust; XTR	■	■	■	■	■	■	■	■	■	■	■	■	372
750-633/040-000 <sup>2)</sup>	Up/Down Counter; Ex i; XTR	■	■	■	■	■	■	■	■	■	■	■	■	392
750-637/040-001	Inc. Encoder; 24 VDC; Diff; 32Bit; XTR	■	■	■	■	■	■	■	■	■	■	■	■	373
<b>Communication Modules XTR</b>														
750-652/040-000	RS232/485 Interface; XTR	■	■	■	■	■	■	■	■	■	■	■	■	374
750-658/040-000	CAN Gateway; XTR	■	■	■	■	■	■	■	■	■	■	■	■	375
<b>Supply and Segment Modules XTR</b>														
750-600/040-000	End Module; XTR	■	■	■	■	■	■	■	■	■	■	■	■	383
750-601/040-000	Power Supply; 24 VDC; Fuse; XTR	■	■	■	■	■	■	■	■	■	■	■	■	376
750-602/040-000	Power Supply; 24 VDC; XTR	■	■	■	■	■	■	■	■	■	■	■	■	376
750-606/040-000	Power supply; 24 VDC; Ex i; XTR	■	■	■	■	■	■	■	■	■	■	■	■	385
750-610/040-000	Power Supply; 24 VDC; Fuse Diagn; XTR	■	■	■	■	■	■	■	■	■	■	■	■	377
750-612/040-000	Power Supply; 0-230 VAC/VDC; XTR	■	■	■	■	■	■	■	■	■	■	■	■	377
750-613/040-000	System Power Supply; 24 VDC; XTR	■	■	■	■	■	■	■	■	■	■	■	■	377
750-614/040-000	Potential distribution; XTR	■	■	■	■	■	■	■	■	■	■	■	■	379
750-616/040-000	Distance Module; XTR	■	■	■	■	■	■	■	■	■	■	■	■	382
750-624/040-000	Field supply filter; 24 VDC; HI; XTR	■	■	■	■	■	■	■	■	■	■	■	■	380
750-624/040-001	Field Supply Filter; 24 VDC; HI; NC; XTR	■	■	■	■	■	■	■	■	■	■	■	■	380
750-626/040-000	Supply Filter; 24 VDC; HI; XTR	■	■	■	■	■	■	■	■	■	■	■	■	381
750-1605/040-000	Potential Distribution; 16*24V; XTR	■	■	■	■	■	■	■	■	■	■	■	■	378
750-1606/040-000	Potential Distribution; 16*0V; XTR	■	■	■	■	■	■	■	■	■	■	■	■	378

<sup>1)</sup> Notice: WAGO's 750-626/040-000 Filter Module is mandatory for marine approval (observe power supply instructions)!

<sup>2)</sup> This I/O module shall only be used in connection with the 24 VDC Ex i XTR supply module (observe power supply instructions)!

■ Approval is available. □ Approval is pending.

# Approvals Overview

## Operation and Monitoring – Touch Panels

Logo	Approval Name	Approval Details	ATEX/IECEX	BRA-Ex	HazLoc	RINA	PRS	NK	LR	KR	DNV GL	BV	ABS	OrdLoc	See Page
	cULus OrdLoc	E175199 Sec. 1, UL 508, UL 61010													
	ABS (American Bureau of Shipping)	19-HG1821926-PDA; 18-HG1778162-PDA; 19-HG1821812-PDA													
	BV (Bureau Veritas)	13453/D0 BV, 30389/B0 BV													
	DNV (Det Norske Veritas) GL (Germanischer Lloyd)	TAA0000194; TAA00000Y7; TAA00001J4; TAA00001FS													
	KR (Korean Register of Shipping)	HMB05880-AC001													
	LR (Lloyd's Register)	02/20026 (E5); 17/20073 (E2)													
	NK (Nippon Kaiji Kyokai)	TA17255M													
	Polski Rejestr Statkow	TE/2210/880590/18; TE/2215/880590/18; TE/2214/880590/18; TE/2190/880590/18													
	RINA (Registro Italiano Navale)	ELE343217XG													
	cULus HazLoc	E198726 Sec. 1, ANSI/ISA 12.12.01 E480271 Sec. 1, AEx UL60079													
	INMETRO	TÜV 12.1297 X; TÜV 14.1911 X													
	TÜV	07ATEX554086 X; IECEX TUN 09.0001 X 12ATEX106032 X; IECEX TUN 12.0039 X 14ATEX148929 X; IECEX TUN 14.0035 X 17ATEX193969 X; IECEX TUN 16.0046 X 17ATEX196484 X; IECEX TUN 17.0005 X DEKRA 11ATEX0203 X													
Item No.	Item Description													See Page	
<b>Touch Panels; e/DISPLAY 7300T</b>			<b>Ex</b>	<b>Marine Approvals</b>										<b>UL</b>	
762-3000	Web Panel; WP; 4.3; 480x272; PIO1														66
762-3001	Web Panel; WP; 5.7; 640x480; PIO1														66
762-3002	Web Panel; WP; 7.0; 800x480; PIO1														67
762-3003	Web Panel; WP 10.1 1280x800 PIO1														67
<b>Touch Panels; 600 Standard Line</b>															
762-4101	Web Panel; TP600; 4.3; 480x272; PIO1; WP														58
762-4102	Web Panel; TP600; 5.7; 640x480; PIO1; WP														59
762-4103	Web Panel; TP600; 7.0; 800x480; PIO1; WP														60
762-4104	Web Panel; TP600; 10.1; 1280x800; PIO1; WP														61
762-4201/8000-001	Visu Panel; TP600; 4.3; 480x272; PIO2; VP														58
762-4202/8000-001	Visu Panel; TP600; 5.7; 640x480; PIO2; VP														59
762-4203/8000-001	Visu Panel; TP600; 7.0; 800x480; PIO2; VP														60
762-4204/8000-001	Visu Panel; TP600; 10.1; 1280x800; PIO2; VP														61
762-4301/8000-002	Control Panel; TP600; 4.3; 480x272; PIO3; CP														58
762-4302/8000-002	Control Panel; TP600; 5.7; 640x480; PIO3; CP														59
762-4303/8000-002	Control Panel; TP600; 7.0; 800x480; PIO3; CP														60
762-4304/8000-002	Control Panel; TP600; 10.1; 1280x800; PIO3; CP														61
<b>Touch Panels; 600 Advanced Line</b>															
762-5203/8000-001	Visu Panel; TP600; 7.0; 800x480; PIO2; VP														62
762-5204/8000-001	Visu Panel; TP600; 10.1; 1280x800; PIO2; VP														63
762-5303/8000-002	Control Panel; TP600; 7.0; 800x480; PIO3; CP														62
762-5304/8000-002	Control Panel; TP600; 10.1; 1280x800; PIO3; CP														63
<b>Touch Panels; 600 Marine Line</b>															
762-6201/8000-001	Control Panel; TP600; 4.3; 480x272; PIO2; VP														64
762-6202/8000-001	Control Panel; TP600; 5.7; 640x480; PIO2; VP														64
762-6203/8000-001	Control Panel; TP600; 7.0; 800x480; PIO2; VP														65
762-6204/8000-001	Control Panel; TP600; 10.1; 1280x800; PIO2; VP														65

■ Approval is available. □ Approval is pending.



## Operating WAGO Connection Technologies

Please follow the applicable product-specific termination instructions:

### PUSH-IN CAGE CLAMP®



Push-in CAGE CLAMP® terminates the following copper conductors: solid



stranded



fine-stranded, also with tinned single strands



fine-stranded, tip-bonded



fine-stranded, with ferrule (gastight crimped)



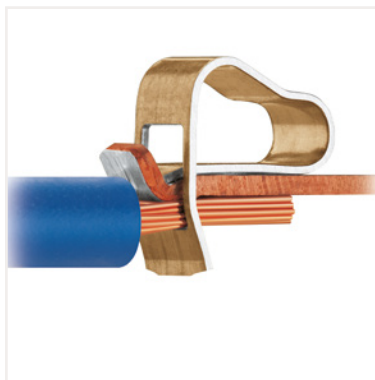
fine-stranded, with pin terminal (gastight crimped)

The universal connection with an additional advantage: Push-in connection  
Terminate solid and stranded, as well as ferruled conductors, by simply pushing them in – no tools required.

Termination for all conductor types:

- Open clamping unit.
- Insert the conductor.
- Release clamp – done!

### CAGE CLAMP®



CAGE CLAMP® terminates the following copper conductors: solid



stranded



fine-stranded, also with tinned single strands



fine-stranded, tip-bonded



fine-stranded, with ferrule (gastight crimped)



fine-stranded, with pin terminal (gastight crimped)

The universal connection for solid, stranded and fine-stranded conductors

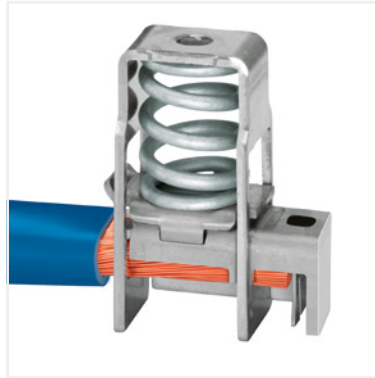
Termination:

- Open clamping unit.
- Insert the conductor.
- Release clamp – done!

## Operating WAGO Connection Technologies

Please follow the applicable product-specific termination instructions:

### POWER CAGE CLAMP®



POWER CAGE CLAMP® terminates the following copper conductors: solid



stranded



fine-stranded, also with tinned single strands



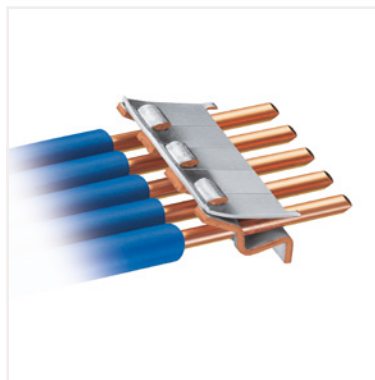
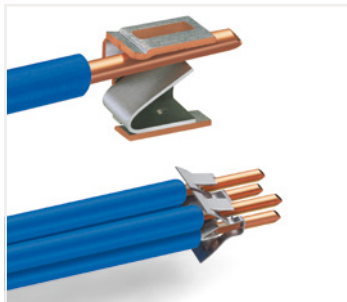
fine-stranded, with ferrule (gastight crimped)

The universal connection for conductors larger than 35 mm<sup>2</sup> (2 AWG)

Termination:

- Open clamp by turning a T-wrench counter-clockwise.
- Press the integrated latch to open clamping unit for hands-free wiring.
- Insert the conductor.
- A short counter-clockwise rotation closes the clamp, securing the conductor.

### PUSH WIRE®



PUSH WIRE® terminates the following copper conductors: solid

PUSH WIRE® connection for solid and stranded conductors (depending on the model used)

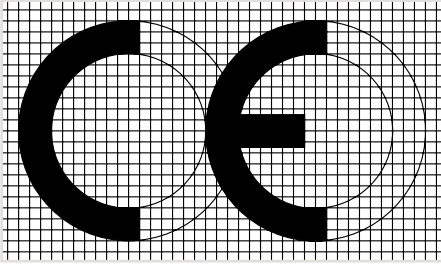
Termination:

Tool-free, twist-free terminations for solid and rigid stranded conductors – simply push into unit.

## CE Marking and EU Directives

### CE Conformity Marking

The CE conformity marking consists of the characters "CE" with the following script:



Communauté Européenne  
(European Community)

The CE conformity marking must be applied to all electrical equipment; should on-unit marking not be possible, mark the smallest packaging unit. With this marking, manufacturers attest conformity of their products to relevant directives.

In addition to the CE marking, manufacturers provide an EU "Declaration of Conformity" for their products. This declaration of conformity must be retained and submitted to a national surveillance authority upon request.

**EU directives are legally binding specifications for the European Union.** Their goal is aligning legal and administrative specifications in the various EU member countries, in order to prevent trading hindrances arising from different national specifications.

In order to launch a product on the market, it must comply with the relevant directives. Several directives may apply for one single product, for example, EMC and low voltage directives.

### Low Voltage Directive (LVD)

The safety of electrical equipment is guaranteed by the Low Voltage Directive (LVD). The LVD covers all electrical equipment operating with a voltage between 50 and 1000 VAC and between 75 and 1500 VDC. Products falling within the scope of the LVD that are designed in such a way that they can be used in other electrical devices and whose safety, for the most part, is dependant on how these components were built into the end product and what features the end product has are defined as basic components in accordance with the LVD. The LVD doesn't apply to basic components.

### EMC Directive

The EMC Directive implies that a product must meet the limits of the radiated electromagnetic disturbance and also requires that a product must be immune to electromagnetic interference. Electromagnetic passive components or components with no direct function, like resistors, diodes, capacitors, switching relays or cables (in the form of passive printed circuit boards) are not considered as apparatus within the meaning of the EMC Directive.

### Machinery Directive

The Machinery Directive does not apply to WAGO products.

### Explosive Atmospheres Directive (ATEX)

Directive for devices and protective systems intended for use in hazardous locations.

### Radio Equipment Directive

A device or relevant component thereof, capable of communication by emitting and/or receiving radio waves utilizing the spectrum allocated to terrestrial/space radio communication, falls within the scope of the Radio Equipment Directive. As such, these devices and components are tested and labeled accordingly. This label implicitly includes both Low Voltage and EMC Directives, since the Radio Equipment Directive also encompasses the safety targets for both of these directives.

## General Technical Information for Electrical Equipment Used in Hazardous Areas

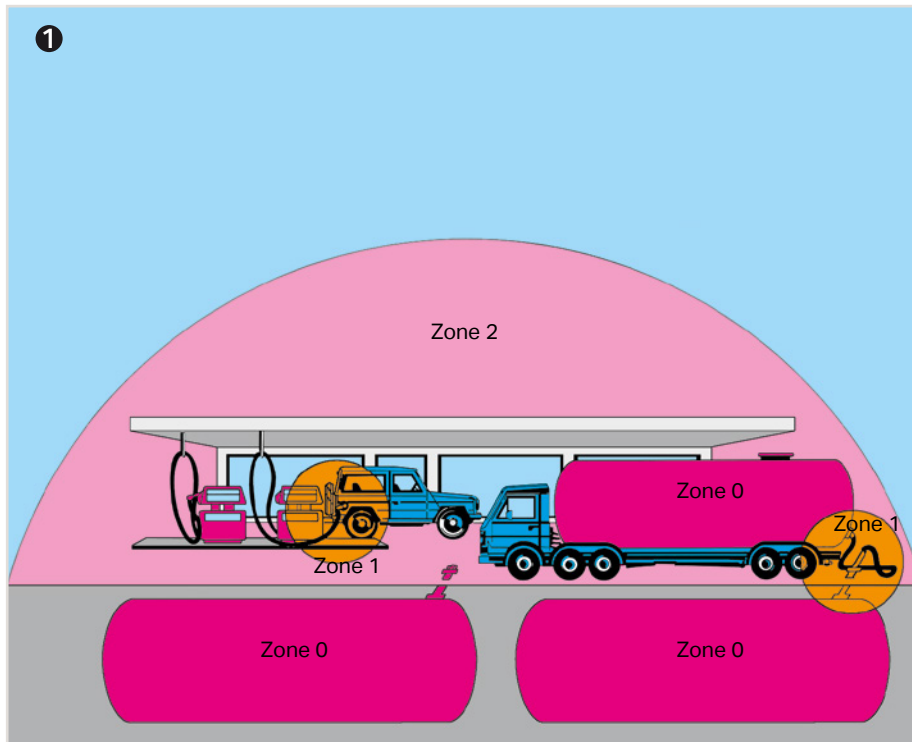
### Hazardous Areas

Hazardous areas are zones in which the atmosphere may become explosive. An explosive atmosphere is a mixture of flammable substances in the form of gases, vapors or mixtures with air under atmospheric conditions in critically mixed ratios such that excessive

high temperature, arcs or sparks may cause an explosion.

DIN EN 1127-1 and all other well-known standards rank hazardous areas according to the

likelihood of the occurrence of an explosive atmosphere into the following zones:



- ① Hazardous areas due to explosive gases, vapors and mists

#### Zone 0

Areas in which an explosive atmosphere is present continuously, for long periods or frequently.

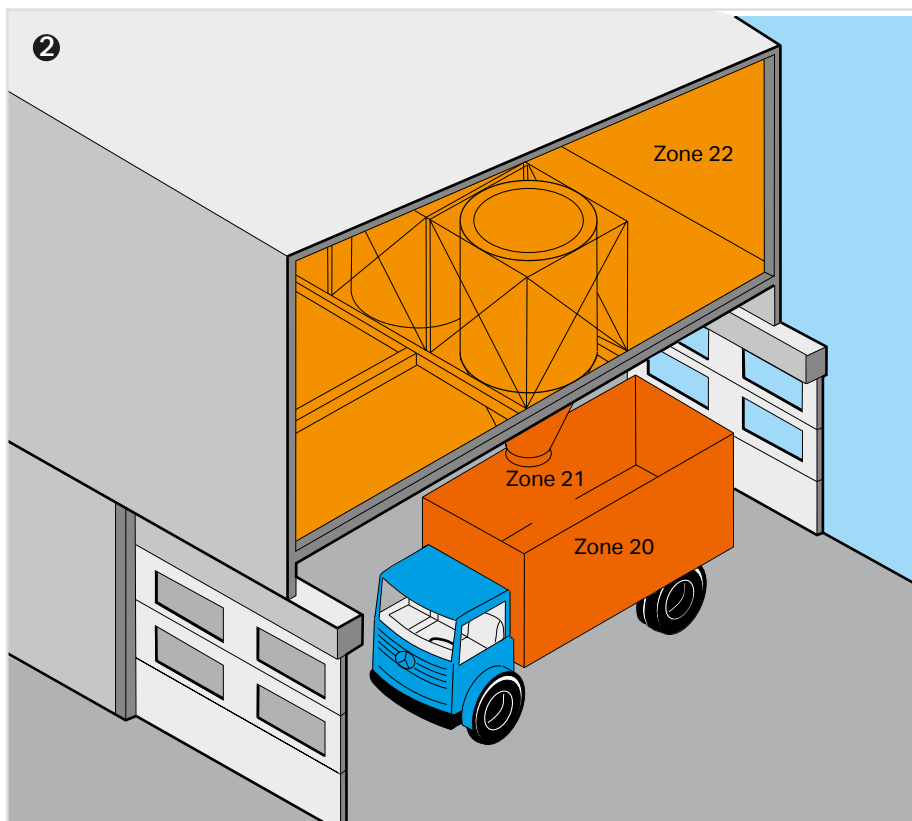
#### Zone 1

Areas in which an explosive atmosphere is likely to occur occasionally during normal operation.

#### Zone 2

Areas in which an explosive atmosphere is likely to occur rarely or only for a short period during normal operation.

- ② Hazardous areas due to explosive dust/air mixtures



#### Zone 20

Areas in which an explosive atmosphere due to dust/air mixtures is present continuously, for long periods or frequently and in which dust deposits of known or excessive thickness may form. Dust deposits alone do not constitute a Zone 20.

#### Zone 21

Areas in which the occurrence of an explosive atmosphere due to dust/air mixtures is to be expected occasionally and in which deposits or layers of combustible dust can generally be present.

#### Zone 22

Areas in which an explosive atmosphere due to dust/air mixtures is not likely to occur during normal operation and, if it occurs, will only exist for a short period, or in which accumulations or layers of combustible dust are present.

Please refer to the manuals for more information on explosion protection.

## Electromagnetic Compatibility and Mechanical Strength (Industrial and Residential Environments)

### Immunity for Industrial Environments per EN 61000-6-2

Test		Test Value	Evaluation Criteria *)
EN 61000-4-2	ESD	4 kV/8 kV (contact/air)	B
EN 61000-4-3	Electromagnetic fields	10 V/m: 80 MHz ... 1 GHz	A
		3V/m: 1.4 ... 2.0 GHz	A
		1V/m: 2.0 ... 2.7 GHz	A
EN 61000-4-4	Burst	1 kV/2 kV (data/supply)	B
EN 61000-4-5	Surge	Data: - / 1 kV (line : line – line : ground)	B
		DC supply: 0.5 kV / 0.5 kV (line : line – line : ground)	B
		AC supply: 1 kV / 2 kV (line : line – line : ground)	B
EN 61000-4-6	RF interference	10 V/m, 80 % AM (0.15 ... 80 MHz)	A
EN 61000-4-8	Magnetic field	30 A/m, 50/60Hz	A
*) Criteria A: The device must work in accordance with the regulations during and after the test. Criteria B: The device must work in accordance with the regulations after the test.			

### Emission Standard for Residential Environments per EN 61000-6-3

Test		Limits (Quasi-Peak)	Frequency Range	Distance
EN 55016-2-1	AC supply, conducted	66 ... 56 dB(μV)	150 ... 500 kHz	
		56 dB(μV)	500 kHz ... 5 MHz	
		60 dB(μV)	5 ... 30 MHz	
EN 55016-2-1	DC supply/data lines, conducted	79 dB(μV)	150 ... 500 kHz	
		73 dB(μV)	500 kHz ... 30 MHz	
EN 55016-2-3	radiated	30 dB(μV/m)	30 ... 230 MHz	10 m
		37 dB(μV/m)	230 MHz ... 1 GHz	10 m
EN 55022	Telecommunications/ Mains connection, conducted	84 ... 74 dB(μV)	150 ... 500 kHz	
		74 dB(μV)	500 kHz ... 30 MHz	

### Emission Standard for Industrial Environments per EN 61000-6-4

Test		Limits (Quasi-Peak)	Frequency Range	Distance
EN 55016-2-1	AC supply, conducted	79 dB(μV)	150 ... 500 kHz	
		73 dB(μV)	500 kHz ... 30 MHz	
EN 55016-2-3	radiated	40 dB(μV/m)	30 ... 230 MHz	10 m
		47 dB(μV/m)	230 MHz ... 1 GHz	10 m
EN 55022	Telecommunications/ Mains connection, conducted	97 ... 87 dB(μV)	150 ... 500 kHz	
		87 dB(μV)	500 kHz ... 30 MHz	

### Mechanical Strength per EN 61131-2

Test		Frequency Range	Limits	
IEC 60068-2-6	Vibration	5 Hz ≤ f < 9 Hz	1.75 mm amplitude (permanent)	
			3.5 mm amplitude (short term)	
		9 Hz ≤ f < 150 Hz	0.5g (permanent)	
			1g (short term)	
Note on vibration test:				
a) Frequency change: max. 1 octave/minute				
b) Vibration direction: 3 axes				
IEC 60068-2-27	Shock		15g	
		Note on shock test:		
		a) Type of shock: half sine		
		b) Shock duration: 11 ms		
c) Shock direction: 3x in positive and 3x in negative direction for each of the three mutually perpendicular axes of the test specimen				



## Electromagnetic Compatibility and Mechanical Strength (Marine Applications)

### Immunity for Marine Applications per Class Guideline DNVGL-CG-0339 (Harmonized with IACS E10)

Test	EMC Class <sup>1)</sup>	Designation	Test Value	Performance Criterion <sup>2)</sup>
IEC 61000-4-2	A and B	ESD	6 kV (contact) 8 kV (air)	B
IEC 61000-4-3	A and B	Electromagnetic fields	10 V/m; 80 MHz ... 2 GHz	A
IEC 61000-4-4	A and B	Burst	1 kV (data ports) 2 kV (power supply/ground ports)	B
IEC 61000-4-5	A and B	Surge	0.5 kV; line-to-line 1.0 kV; line-to-ground	B
IEC 61000-4-6	A B	RF interference	3 V r.m.s.; 150 kHz ... 80 MHz; 80 % AM at 1000 Hz 10 V r.m.s.; 2/3/4/6.2/8.2/12.6/16.5/18.8/22/25 MHz (spot frequencies)	A
Performance test	A and B	AF disturbances (harmonics)	3 V r.m.s.; 2 W; 50 Hz ... 10 kHz	A
Performance test	-	High voltage	775 VDC 1500 VAC	-
<sup>1)</sup> EMC Class A: All locations except bridge and open deck EMC Class B: All locations including bridge and open deck				
<sup>2)</sup> Performance criteria A: The device must work in accordance with the regulations during and after the test. Performance criteria B: The device must work in accordance with the regulations after the test.				

### Emission Standard for Marine Applications per Class Guideline DNVGL-CG-0339 (Harmonized with IACS E10)

Test	EMC Class <sup>1)</sup>	Emission	Frequency Range	Limits (Quasi-Peak)	Distance
Performance test	A	radiated	0.15 ... 30 MHz	80 ... 50 dB $\mu$ V/m	3 m
			30 ... 100 MHz	60 ... 54 dB $\mu$ V/m	3 m
			100 ... 2000 MHz (except 156 ... 165 MHz)	54 dB $\mu$ V/m 24 dB $\mu$ V/m	3 m
Performance test	A	conducted	10 ... 150 kHz	120 ... 69 dB $\mu$ V	
			150 ... 500 kHz	79 dB $\mu$ V	
			0.50 ... 30 MHz	73 dB $\mu$ V	
Performance test	B	radiated	150 ... 300 kHz	80 ... 52 dB $\mu$ V/m	3 m
			0.30 ... 30 MHz	52 ... 34 dB $\mu$ V/m	3 m
			30 ... 2000 MHz (except 156 ... 165 MHz)	54 dB $\mu$ V/m 24 dB $\mu$ V/m	3 m
Performance test	B	conducted	10 ... 150 kHz	96 ... 50 dB $\mu$ V	
			150 ... 350 kHz	60 ... 50 dB $\mu$ V	
			0.35 ... 30 MHz	50 dB $\mu$ V	
<sup>1)</sup> EMC Class A: All locations except bridge and open deck EMC Class B: All locations including bridge and open deck					

### Mechanical Strength per Class Guideline DNVGL-CG-0339 (Harmonized with IACS E10)

Test	Vibration Class	Frequency Range	Amplitude	Location
IEC 60068-2-6	A	2 Hz (+3/-0) $\leq$ f < 13.2 Hz 13.2 Hz $\leq$ f < 100 Hz	1.0 mm (peak value) 0.7g (acceleration)	On bulkheads, beams, deck, bridge
IEC 60068-2-6	B	2 Hz (+3/-0) $\leq$ f < 25 Hz 25 Hz $\leq$ f < 100 Hz	1.6 mm (peak value) 4.0g (acceleration)	On machinery such as internal combustion engines, compressors, pumps, including piping on such machinery
		40 Hz $\leq$ f < 2000 Hz	10g (acceleration)	Only for equipment installed on the exhaust gas pipes of diesel engines
IEC 60068-2-6	C	2 Hz (+3/-0) $\leq$ f < 15 Hz 15 Hz $\leq$ f < 50 Hz	2.6 mm (peak value) 2.3g (acceleration)	Masts

## Specifications and Test Results

The following standards apply to the design and application of the electrical components contained in this catalog:

DIN VDE 0100 Construction of high-current installations with nominal voltages up to 1000 V	IEC 60529 EN 60529 VDE 0470-1 Degrees of protection provided by enclosures (IP code)	IEC 60998-2-2 EN 60998-2-2 VDE 0613-2-2 Connecting devices for low-voltage circuits for household and similar purposes – Part 2-2: Particular requirements for connecting devices as separate entities with screwless-type clamping units
EN 50110-1 VDE 0105-1 Operation of electrical installations	IEC 60603-1 EN 60603-1 Connectors for frequencies below 3 MHz for use with printed boards – Part 1: Generic specification: General requirements and guide for the preparation of detail specifications, with assessed quality	IEC 60947-1 EN 60947-1 VDE 0660-100 Low-voltage switchgear and controlgear – Part 1: General rules
IEC 61140 EN 61140 VDE 0140-1 Protection against electric shock – Common aspects for installation and equipment	IEC 61984 EN 61984 VDE 0627 Connectors – Safety requirements and tests	IEC 60947-5-6 EN 60947-5-6 VDE 0660-212 Low-voltage switchgear and controlgear – Part 5-6: Control circuit devices and switching elements, DC interface for proximity sensors and switching amplifiers (NAMUR)
IEC 60664-1 EN 60664-1 VDE 0110-1 Insulation coordination for equipment within low-voltage systems – Part 1: Principles, requirements and tests	IEC 60999-1 EN 60999-1 VDE 0609-1 Connecting devices – Electrical copper conductors; Safety requirements for screw-type and screwless-type clamping units – Part 1: General requirements and particular requirements for clamping units for conductors 0.2 mm <sup>2</sup> up to 35 mm <sup>2</sup>	IEC 60439-1 EN 60439-1 VDE 0660-500 Low-voltage switchgear and controlgear assemblies – Part 1: Type-tested and partially type-tested assemblies
IEC 60204-1 EN 60204-1 VDE 0113-1 Safety of machinery – Electrical equipment of machines – Part 1: General requirements	IEC 60617-2 EN 60617-2 Graphical symbols for diagrams – Part 2: Symbol elements, qualifying symbols and other symbols having general application	IEC 60555-1 EN 60555 Part 1 VDE 0838-1 Disturbances in supply systems caused by household appliances and similar electrical equipment; Part 1: definitions
EN 50178 VDE 0160 Electronic equipment for use in power installations	IEC 61558-1 EN 61558-1 VDE 0570-1 Safety of power transformers, power supplies, reactors and similar products – Part 1: General requirements and tests	IEC 60715 EN 60715 Dimensions of low-voltage switchgear and controlgear – Standardized mounting on rails for mechanical support of electrical devices in switchgear and controlgear installations
IEC 62305-1 EN 62305-1 VDE 0185-305-1 Protection against lightning – Part 1: General principles	IEC 60669-2-1 EN 60669-2-1 VDE 0632-2-1 Switches for household and similar fixed electrical installations – Part 2-1: Particular requirements – Electronic switches	IEC 60950-1 EN 60950-1 VDE 0805-1 Information technology equipment – Safety Part 1: General requirements
IEC 60060-1 HD 588.1 S1 VDE 0432-1 High-voltage test techniques – Part 1: General specifications and test requirements	IEC 60947-7-1 EN 60947-7-1 VDE 0611-1 Low-voltage switchgear and controlgear – Part 7-1: Ancillary equipment – Terminal blocks for copper conductors	IEC 60127-6 EN 60127-6 VDE 0820-6 Miniature fuses – Part 6: Fuse-holders for miniature fuse-links
IEC 60085 EN 60085 VDE 0301-1 Electrical insulation – Thermal evaluation and designation		

EN 50155 VDE 0115-200 Railway applications – Electronic equipment used on rolling stock	<b>Interfaces – Fieldbuses</b>  DIN 66259-1 Electrical characteristics for unbalanced double-current interchange circuits	IEC 60079-14 EN 60079-14 VDE 0165-1 Explosive atmospheres – Part 14: Electrical installations design, selection and erection
EN 50090-2-2 VDE 0829-2-2 Home and Building Electronic Systems (HBES) – Part 2-2: System overview – General technical requirements; German version	EN 50325-1 Industrial communications subsystem based ISO 11898 (CAN) for controller-device interfaces – Part 1: General requirements	IEC 60079-15 EN 60079-15 VDE 0170-16 Electrical apparatus for explosive gas atmospheres – Part 15: Construction, test and marking of type of protection "n" electrical apparatus
IEC 60099-1 EN 60099-1 VDE 0675-1 Surge arresters – Part 1: Non-linear resistor type gapped surge arresters for a.c. systems	IEC 61784-1 EN 61784-1 Industrial communication networks – Profiles – Part 1: Fieldbus profiles	IEC 61241-0 EN 61241-0 VDE 0170-15-0 Electrical apparatus for use in the presence of combustible dust – Part 0: General requirements
IEC 61643-1 EN 61643-11 VDE 0675-6-11 Low-voltage surge protective devices – Part 11: Surge protective devices connected to low-voltage power systems – Requirements and tests	IEC 61158-2 EN 61158-2 Industrial communication networks – Fieldbus specifications – Part 2: Physical layer specification and service definition	IEC 61241-1 EN 61241-1 VDE 0170-15-1 Electrical apparatus for use in the presence of combustible dust – Part 1: Protection by enclosures "tD"
IEC 61643-21 EN 61643-21 VDE 0845-3-1 Low voltage surge protective devices – Part 21: Surge protective devices connected to telecommunications and signalling networks; Performance requirements and testing methods	IEC 61158-6-x EN 61158-6-x DIN EN 61158-6-x Industrial communication networks – Fieldbus specifications – Part 6-x	IEC 61241-11 EN 61241-11 VDE 0170-15-11 Electrical apparatus for use in the presence of combustible dust – Part 11: Protection by intrinsic safety "iD"
IEC 61508-1 EN 61508-1 VDE 0803-1 Functional safety of electrical/electronic/programmable electronic safety-related systems – Part 1: General requirements	<b>Explosion Protection</b>  IEC 60079-0 EN 60079-0 VDE 0170-1 Electrical apparatus for explosive gas atmospheres – Part 0: General requirements	
IEC 62061 EN 62061 VDE 0113-50 Safety of machinery – Functional safety of safety-related electrical, electronic and programmable electronic control systems	IEC 60079-7 EN 60079-7 VDE 0170-6 Explosive atmospheres – Part 7: Equipment protection by increased safety "e"	
	IEC 60079-11 EN 60079-11 VDE 0170-7 Explosive atmospheres – Part 11: Equipment protection by intrinsic safety "i"	

## Specifications and Test Results Continued

### Environmental Testing

IEC 60068-2-6  
EN 60068-2-6  
VDE 0468-2-6  
Environmental testing – Part 2-6: Tests – Test Fc: Vibration (sinusoidal)

IEC 60068-2-27  
EN 60068-2-27  
Basic environmental testing procedures – Part 2: Tests  
– Test Ea and guidance: Shock

IEC 60068-2-42  
EN 60068-2-42  
Environmental testing – Part 2-42: Tests – Test Kc: Sulfur dioxide test for contacts and connections

IEC 60068-2-43  
EN 60068-2-43  
Environmental testing – Part 2-43: Tests – Test Kd: Hydrogen sulphide test for contacts and connections

### EMC Requirements

IEC 61000-6-1  
EN 61000-6-1  
VDE 0839-6-1  
Electromagnetic compatibility (EMC) – Part 6-1: Generic standards  
– Immunity for residential, commercial and light-industrial environments

IEC 61000-6-2  
EN 61000-6-2  
VDE 0839-6-2  
Electromagnetic compatibility (EMC) – Part 6-2: Generic standards  
– Immunity for industrial environments

IEC 61000-6-3  
EN 61000-6-3  
VDE 0839-6-3  
Electromagnetic compatibility (EMC) – Part 6-3: Generic standards – Emission standard for residential, commercial and light-industrial environments

IEC 61000-6-4  
EN 61000-6-4  
VDE 0839-6-4  
Electromagnetic compatibility (EMC) – Part 6-4: Generic standards  
– Emission standard for industrial environments

IEC 61000-3-2  
EN 61000-3-2  
VDE 0838-2  
Electromagnetic compatibility (EMC) – Part 3-2: Limits  
– Limits for harmonic current emissions (equipment input current  $\leq 16$  A per phase)

IEC/CISPR 11  
EN 55011  
VDE 0875-11  
Industrial scientific and medical (ISM) radio-frequency equipment  
– Electromagnetic disturbance characteristics  
– Limits and methods of measurement

IEC/CISPR 22  
EN 55022  
VDE 0878-22  
Information technology equipment  
– Radio disturbance characteristics  
– Limits and methods of measurement

IEC/CISPR 24  
EN 55024  
VDE 0878-24  
Information technology equipment  
– Immunity characteristics  
– Limits and methods of measurement

IEC 61326-3-1  
EN 61326-3-1  
VDE 0843-20-3-1  
Electrical equipment for measurement, control and laboratory use – EMC requirements – Part 3-1: Immunity requirements for safety-related systems and for equipment intended to perform safety-related functions (functional safety) – General industrial applications

**PLC**

IEC 61131-1  
EN 61131-1  
Programmable Logic Controllers –  
Part 1: General Information

IEC 61131-2  
EN 61131-2  
VDE 0411-500  
Programmable controllers –  
Part 2: Equipment requirements and tests

IEC 61131-3  
EN 61131-3  
Programmable controllers –  
Part 3: Programming languages

**Relays**

IEC 61810-1  
EN 61810-1  
VDE 0435-201  
Electromechanical elementary relays – Part 1:  
General requirements

IEC 61810-2  
EN 61810-2  
VDE 0435-120  
Electromechanical elementary relays – Part  
2: Reliability

IEC 61810-5  
EN 50205  
VDE 0435-2022  
Electromechanical non-specified time all-or-  
nothing relays – Part 5: Insulation coordina-  
tion

IEC 60255-5  
EN 60255-5  
VDE 0435-130  
Electrical relays – Part 5: Insulation coordi-  
nation for measuring relays and protection  
equipment – Requirements and tests

**UL Directives**

UL 1059; ANSI 1059  
Rail-Mount Terminal Blocks

UL 486E  
Equipment wiring terminals for use with alu-  
minum and/or copper conductors

UL 508  
Industrial control equipment

ANSI/ISA12.12.01  
Nonincendive electrical equipment for use  
in Class I and Class II, Division 2 and Class III  
hazardous (classified) locations

**Ship Classifications**

ABS (American Bureau of Shipping)  
Steel Vessels  
Part 4: Vessel Systems and Machinery

BV (Bureau Veritas)  
Rules for the classification of steel ships and  
offshore units

DNV (Det Norsk Veritas)  
Det Norsk Veritas' Rules for Classification  
of Ships, High Speed & Light Craft and Det  
Norsk Veritas' Offshore Standards: 2007

GL (Germanischer Lloyd)  
Rules for Classification and Construction  
VI Additional Rules and Guidelines  
7 Guidelines for the Performance of  
Type Test  
2 Test Requirements for Electrical/Electronic  
Devices and Systems

LR (Lloyd's Register)  
Type Approval System  
Test Specification Number1

RINA (Registro Italiano Navale)  
Rules for the classification of ships  
Part C – Machinery, systems and fire protec-  
tion Ch.3, Sect.6, Table1

BSH (Federal Maritime and Hydrographic  
Agency)  
Certificate measuring the safe distance to  
the standard magnetic and steering magnetic  
compass in accordance with ISO R 695 and  
DIN EN 60945 Section 11.2

KR (Korean Register of Shipping)  
List of approved Manufacturers And Type  
Approval Equipment; Pt.6, Ch.1, Sec.3 of the  
Rules for Classification, Steel Ships

NKK (Nippon Kaiji Kyokai)  
Guidance for the approval and type approval  
of materials and equipment for marine use

PRS (Polski Rejestr Statkow)  
Publication No.11/P  
Enviromental Tests on Marine Equipment

## Electrical Engineering Laboratory Product Safety for Our Customers

To use terminal blocks globally, they must satisfy certain standards and obtain test certificates.

These requirements apply to every manufacturer. WAGO also performs its own tests to increase standards and offer greater reliability with its products. Products undergo different mechanical, electrical and climatic testing, including the following examples.

### WAGO Test Lab

#### Pull-Out Test (per EN 60947-7-1, EN 60998-2-2)

In the pull-out force test, a conductor is pulled on until it is removed from the clamping unit. The design of the terminals means that extraction only occurs after the standard pull-out force has been exceeded many times over.

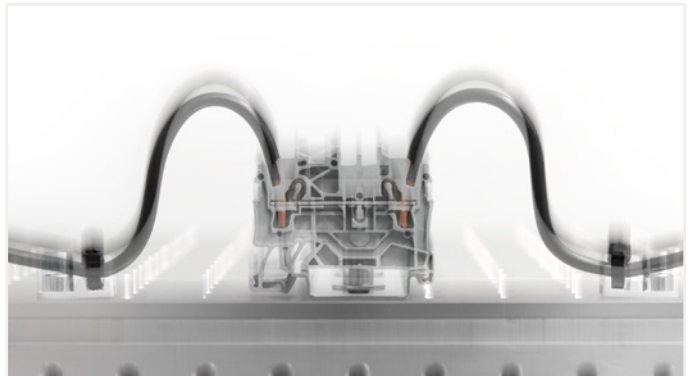
These tests confirm that WAGO's products can be used safely and reliably both on the European market and anywhere in the world for a wide variety of applications. We place great value on this, starting in development. As a result, we can present verifiably high levels of product safety and reliability while ensuring the fulfillment and accuracy of technical data, which are the highest priorities for our customers and users worldwide.

On December 22, 2009, our test lab was accredited by the German Accreditation Association (Deutsche Gesellschaft für Akkreditierung GmbH) in accordance with DIN EN ISO/IEC 17025.



#### Vibration Test (per IEC/EN 60068-2-6)

Depending on the application, such as railway (per EN 61373) or marine (per GL, LR, DNV), there are various testing requirements to determine if the long-term effects of vibrations degrade electrical connections. The test specimen is subjected to different loads on three axes in an electrodynamic vibration system. The amplitude, the acceleration and, in particular, the frequency of the vibration vary during the test. The test values are increased multiple times over the standard values to meet specific customer requirements.



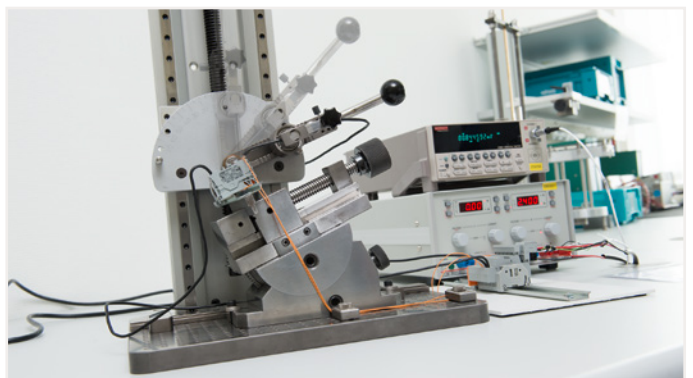
#### Shock Test (per IEC/EN 60068-2-27)

The shock test is very similar to the vibration test except that single shocks are applied to the test specimen, instead of continuous vibrations. Shock tests are usually performed, for example, at an acceleration of 20g over a period of 11 ms. Tests for special requirements often call for much higher values and are also conducted in our laboratory. WAGO's single-deck TOPJOB® S Rail-Mount Terminal Blocks, for example, pass shock tests up to 500 g.



#### Voltage Drop Test under Bending Stress (per EN 60947-7-1, EN 60999-1)

The voltage drop test under bending stress simulates mechanical stress on the clamping unit. In everyday use, this stress can occur during installation, for example, when an electrician shoves connected conductors to the side in order to access a specific component. The quality of the clamping unit when moving a connected conductor can be validated by the constantly stable measured value of the voltage drop.





## Deutsche Akkreditierungsstelle GmbH

**Beliehene gemäß § 8 Absatz 1 AkkStelleG i.V.m. § 1 Absatz 1 AkkStelleGBV**  
Unterzeichnerin der Multilateralen Abkommen  
von EA, ILAC und IAF zur gegenseitigen Anerkennung

# Akkreditierung



Die Deutsche Akkreditierungsstelle GmbH bestätigt hiermit, dass das Prüflaboratorium

**WAGO Kontakttechnik GmbH & Co. KG**  
**Hansastraße 27, 32423 Minden**

die Kompetenz nach DIN EN ISO/IEC 17025:2005 besitzt, Prüfungen in folgenden Bereichen durchzuführen:


**Elektrische und mechanische Prüfungen an Klemmen und Steckverbinder  
sowie Umweltsimulation**

Die Akkreditierungsurkunde gilt nur in Verbindung mit dem Bescheid vom 18.12.2014 mit der Akkreditierungsnummer D-PL-19704-01 und ist gültig bis 17.12.2019. Sie besteht aus diesem Deckblatt, der Rückseite des Deckblatts und der folgenden Anlage mit insgesamt 5 Seiten.

Registrierungsnummer der Urkunde: **D-PL-19704-01-00**

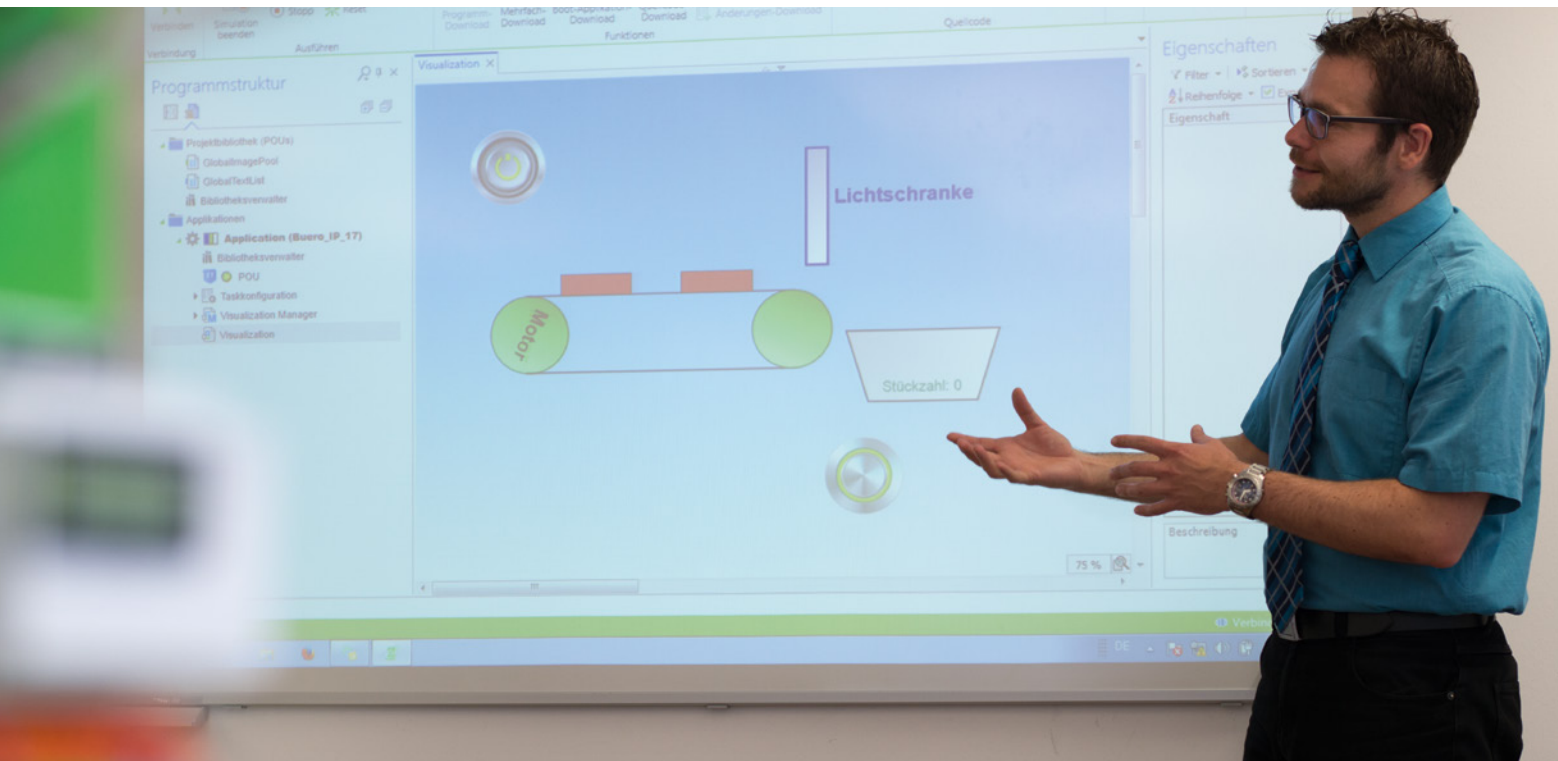
Frankfurt am Main, 18.12.2014

Siehe Hinweise auf der Rückseite

  
Im Auftrag Dipl.-Ing. (FH) Ralf Egner  
Abteilungsleiter

## WAGO Seminars

### Learn Today – Benefit Tomorrow



## Setting the Bar with Your Goals

### Product-Related and Customer-Specific Seminars



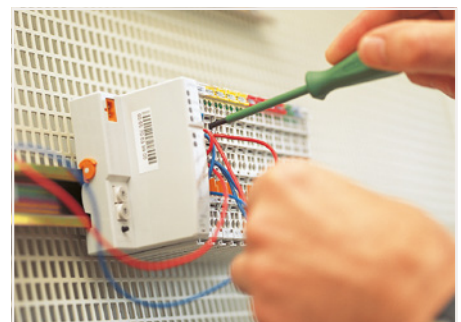
#### Small Groups

The small class sizes of WAGO training seminars ensures that no question goes unanswered and no one is overlooked.



#### Teamwork

Learning as a group is very effective. Ideas can be discussed and exchanged while experiences can be shared – all for the benefit of the participants.



#### Practical Topics

Experience has shown that practice makes perfect. This is why the focus of every WAGO training seminar is on practical, hands-on learning.



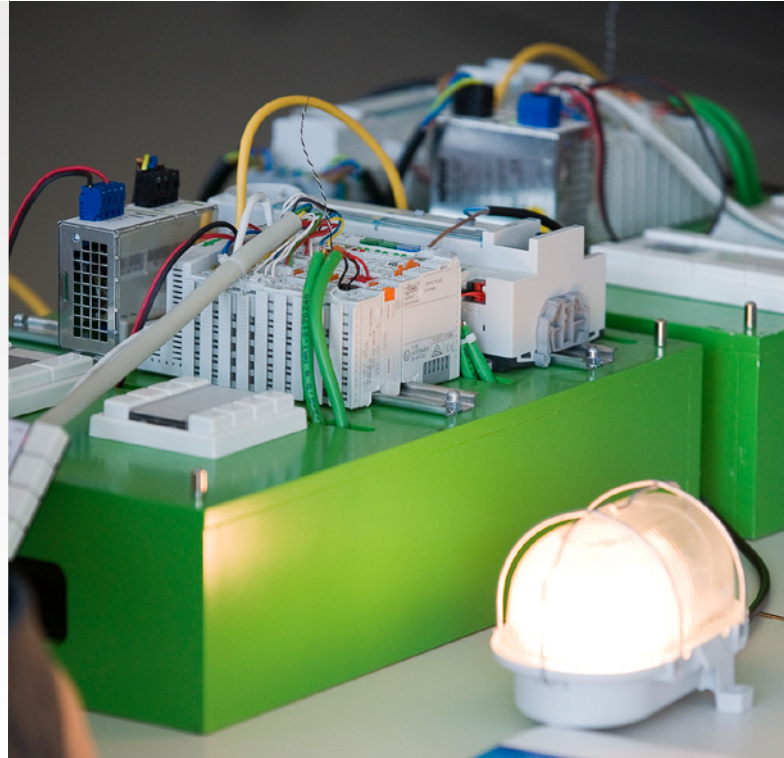
## WAGO Seminars

### Benefit from First-Hand Knowledge and Expertise – Training Straight from the Source!

Our instructors are specialists who know all the ins and outs of WAGO's products. This ensures that the time devoted to each WAGO training seminar is an effective investment in expanding your own expertise.

Request your registration form by email:  
[training@wago.com](mailto:training@wago.com)

**Contact your local  
WAGO office.**



#### Product-Related Seminars

We regularly offer product-related seminars on the following topics:

- Building and industrial automation
- Programming of automation components
- Fieldbus systems

**Current Seminars:  
[www.wago.com](http://www.wago.com)**

#### Customer-Specific Seminars

In addition to these "open" seminars, we also offer seminars specially tailored to your organization and its particular needs.

Upon request, we can also conduct these courses at your location.

**Special  
Corporate Seminars**



## Indexes and Addresses

# Indexes and Addresses

## Contents

	Page
Product Index	546
Item Number Index	548
WAGO Worldwide	556

## Product Index

Item	Section	Item	Section	Item	Section
<b>A</b>		DALI multi-sensor	10	Fuse holder	5.10
Actuator cables	10	DALI power supply	10	<b>G</b>	
Aluminum system housing	10	DALI/DSI master	5.7	Group marker carriers	10
Analog input modules	5.4, 5.9, 6	DC drive controller	5.6	<b>H</b>	
Analog output modules	5.5, 5.9, 6	DC/DC converters, DIN-rail mount	10	HART protocol	5.4, 5.9, 6
Antenna (SMA plug)	10	DeviceNet fieldbus components	4, 5.1, 10	<b>I</b>	
Application	1	Differential input	5.4, 5.9, 6	I/O systems	5, 6
Approvals	11	Differential measurement input	5.4, 5.9, 6	IEC 60870/IEC 61850 configurator	2
AS-Interface master	5.7	Digital impulse interface	5.6	IEC/EN specifications	11
<b>B</b>		Digital input modules	5.2, 5.8, 5.9, 6	IEC/EN specifications	11
Backup capacitor module	10	Digital input/output	5.2, 5.3	Incremental encoder interface	5.6
BACnet configurator	2	Digital output modules	5.3, 5.8, 5.9, 6	Industrial managed switches	7
BACnet MS/TP	4.3	DIN-rail	10	Industrial switches	7
BACnet/IP	4.3	DIN-rail adapter	10	INTERBUS fieldbus components	5.1, 10
Binary placeholder module	5.10	Distribution cables (sensor/actuator)	10	Interface adapter	10
Bluetooth® adapter	8	Down counter	5.6, 6	Interface cables	10
Building automation	2, 5.7, 10	<b>E</b>		Interface modules for system wiring	10
Bus end module	5.10, 6	e!COCKPIT	2	Interference-free for use in safety functions	5.3
Bus extension	5.10	EC directives	11	Intrinsically safe modules	5.9
Busbar carriers	10	EDS files	4, 5.1, 6	Intrinsically safe modules Ex i	5.9
<b>C</b>		EDS files	4, 5.1, 6	Intruder detection	5.2
Cable assemblies	10	Electronic circuit breakers	10	IO-Link master	5.7
Cable cutter	10	Enclosures for the WAGO-I/O-SYSTEM	10	Item Number Index	12
Cable entry plates	10	End stops	10	<b>K</b>	
Cable strippers	10	Energy data management	1	KNX/EIB/TP1 interface	5.7
Cables and pluggable connectors	10	Engineering software	2	KNX/IP	4.3
Cables, pre-assembled	10	EnOcean buttons	8	<b>L</b>	
CAGE CLAMP® connection	11	EnOcean radio technology	8	Libraries	2
CAN gateway	5.7	EtherCAT®	5.1	Lighting control DALI/DSI	5.7
CANopen fieldbus components	3 ... 5, 10	ETHERNET connector	10	Lighting management	1
Capacitive buffer modules	10	ETHERNET fieldbus components	3, 4, 5.1, 6	Linux® controller	4
CC-Link	5.1	Extended input voltage and temperature range	6	Local bus extension	5.10
CC-Link fieldbus connector	10	<b>F</b>		LON® configurator	2
CE marking	11	Fail-safe digital input	5.8	LON® FTT interface	5.7
Cloud connectivity	1	Fail-safe digital input and relay output	5.8	<b>M</b>	
Cloud solutions	1	Fail-safe digital input/output	5.8	Magnetic antenna	10
Commissioning software	2	Fieldbus components	3 ... 6	Marker adapters	10
Communication cable RS-232	2, 10	Fieldbus connectors	10	Marker cards	10
Communication modules	5.7, 6	Fieldbus controllers	4	Marker carrier	10
Companies and representatives (WAGO worldwide)	12	Fieldbus couplers	5.1, 6	Marking systems	10
Condition monitoring	5.6	Field-side connection module	5.10, 6	Memory card	3
Configurable shielded pluggable connectors	10	Field-side power supply filter module	5.10, 6	Mini-WSB quick marking system	10
Configuration files	2	Filter module for field-side power supply	5.10, 6	Mobile software	2
Configuration software	2	Flange plates	10	Modbus® fieldbus components	4, 5.1, 6
Connection cables	9, 10	Frequency counter	5.6	Modular I/O system	
Connector, pluggable	5	Function and technology modules	5.6, 5.9, 6	WAGO-I/O-SYSTEM 750	5
Control panels	3	Function blocks for building automation	2	Multi-port device taps for DeviceNet	10
Controllers	4	Functional safety	5.8		
Crimping tools	10				
<b>D</b>					
DALI configurator	2				

Item	Section	Item	Section	Item	Section
<b>N</b>		Sensor/actuator boxes	9	<b>V</b>	
NAMUR	5.2, 5.9, 6	Sensor/actuator cable	10	Vibration velocity/bearing condition monitoring	5.6
Operating tools	10	Sercos®	5.1		
<b>P</b>		Serial data exchange interface	5.7	<b>W</b>	
Parameterization software	2	Serial data exchange interface	5.7	WAGO in Germany	12
Peak-time counter	5.6, 6	Serial interface	4, 5.7, 6	WAGO Interface Cables	10
PFC100	4	Serial interface RS-232 C	5.7, 6	WAGO Ribbon Cables	10
PFC200	4	Serial interface RS-232/485	4.7	WAGO WebVisu App	2
Placeholder module	5.10	Serial interface RS-485	5.7	WAGO WebVisu	2
Pluggable connector	5	Serial TTY interface	5.7	WAGO Worldwide	12
Plug-ins	2	Servo stepper controller	5.6	WAGO-I/O-CHECK	2
Polyester system housing	10	SFP modules	7	WAGO-I/O-PRO	2
Power supplies	10	Sheet-steel system housing	10	Web Panels	3
Power supply filter	5.10, 6	Shield clamping saddles	10	Wire strippers	10
Power supply units	10	Shield clamps	10	Wireless ETHERNET gateway	8
PROFIBUS fieldbus components	4, 5.1, 6, 10	Shield connection system	10	WLAN	8
PROFINET connector	10	Shield termination	10	WMB Inline markers	10
PROFINET IO	5.1	Single-ended	5.4, 5.9, 6	WMB multi marking system	10
PROFIsafe, safety modules	5.8	Software solutions	1	WSB quick marking system	10
Programming and configuration software	2	Solid-state relays	5.3		
Proportional valve module	5.6	Spacer module	5.10, 6	<b>X</b>	
Proximity sensor	5.2	Spring-equipped shield clamping saddles	10	XTR	4, 6
Proximity sensor	5.2, 5.9	SSI transmitter interface	5.6, 6		
Pt100 analog input module	5.4, 5.9, 6	Stainless-steel system housing	10		
PTC thermistor (connection)	5.2	Stepper controller	5.6		
Pulse extension	5.2	Stepper module	5.6		
Pulse width outputs	5.6	Stripping tools	10		
Push-in CAGE CLAMP® connection	11	Subsidiaries and representatives (WAGO worldwide)	12		
<b>R</b>		Supply and segment modules	5.10, 6		
Radio adapter	10	Supply module	5.10, 6		
Radio receiver EnOcean	5.7, 8	Supply modules	5.10, 6		
Radio technology Bluetooth®	8	Switched-mode power supplies	10		
Radio transmitter	8	System housing	10		
Rail end cap for DIN-35 rail	10	System power supply	5.10, 6		
Real-time clock module	5.6	System wiring	10		
Redundancy module	10	<b>T</b>			
Relay output	5.3, 6	3-phase power measurement	5.4, 6		
Resistance measurement	5.4, 5.9, 6	Technical information	11		
Resistance sensors	5.4, 5.9, 6	Telecontrol technology	4, 5.1, 6		
Resistive temperature device (RTD)	5.4, 5.9, 6	Telecontroller	4		
Resistor bridges (strain gauge)	5.4	Test and measurement devices	10		
Ribbon cables	5.2, 5.3, 10	Thermocouple	5.4, 5.9, 6		
RJ-45 connectors	10	Thermocouple	5.4, 5.9, 6		
Rogowski coils	5.4, 6	Tools	10		
RS-232 communication cable	2	Torque wrench	10		
RS-232 serial interface	5.7	Touch monitors	3		
RS-485 serial interface	5.7	Training courses and seminars	11		
RTC module	5.6	TTY interface	5.7		
Runtime software	2	<b>U</b>			
<b>S</b>		Uninterruptible power supplies (UPS)	10		
Screwdrivers (see operating tools)	10	Up/down counter	5.6, 6		
Segment modules	5.10, 6	USB communication cable	2		

## Item Number Index

Item No.	Page	Item No.	Page	Item No.	Page
<b>206 Series</b>		247-511	504	704-2054	452
206-118	509	247-512	504	704-5003	452
206-701	466	247-513	504	704-5004	452
206-706	513	247-514	504	704-5013	452
206-707	513	247-515	504	704-5014	452
206-804	512	247-516	504	704-5024	452
206-808	513	247-517	504	704-5034	452
206-810	512	247-518	504	704-5044	452
206-816	512	247-519	504	704-5054	452
206-1125	511	247-520	504	704-5064	452
206-1126	511	247-521	504	704-5074	452
206-1127	511	247-522	504	<b>706 Series</b>	
206-1128	511	247-523	504	706-3057/300-100	454
206-1129	511	247-524	504	706-3057/300-200	454
206-1131	511	247-525	504	706-3057/300-300	454
206-1132	511	247-526	504	706-3057/1300-300	454
206-1400	510	247-527	504	706-7753/300-100	455
206-1403	510	247-528	504	706-7753/300-200	455
206-1411	510	247-529	504	706-7753/301-200	455
206-1412	510	247-530	504	706-7753/302-100	454
206-1413	510	247-531	504	706-7753/302-200	454
206-1414	510	247-532	504	706-7753/304-xxx	453
206-1415	510	247-533	504	706-7753/306-xxx	453
206-1418	510	247-534	504	<b>709 Series</b>	
206-1419	510	247-535	504	709-178	505
206-1441	510	247-536	504	709-350	500
206-1442	510	247-537	504	709-352	500
206-1451	510	247-538	504	<b>750 Series</b>	
206-1481	511	247-539	504	750-100	505
206-1482	511	247-540	504	750-103	505
206-1491	511	247-541	504	750-105	505
206-1492	511	247-542	504	750-106	505
<b>209 Series</b>		247-543	504	750-107	505
209-109	507	247-544	504	750-303	149
<b>210 Series</b>		247-544/000-006	504	750-304	160
210-110	444	247-545	504	750-306	155
210-112	506	247-545/000-005	504	750-307	156
210-113	506	247-546	504	750-310	161
210-114	507	247-546/000-006	504	750-315/300-000	159
210-115	506	247-547	504	750-316/300-000	159
210-118	507	247-552	504	750-325	161
210-133	501	247-552/000-017	504	750-330	153
210-148	506	<b>248 Series</b>		750-331	150
210-149	506	248-501	504	750-333	149
210-196	506	248-501/000-002	504	750-333/025-000	149
210-197	507	248-501/000-005	504	750-333/040-000	352
210-198	506	248-501/000-006	504	750-337	156
210-504	506	248-501/000-007	504	750-337/025-000	156
210-505	506	248-501/000-012	504	750-338	157
210-506	507	248-501/000-017	504	750-338/040-000	354
210-508	507	248-501/000-023	504	750-342	152
210-719	509	248-501/000-024	504	750-343	150
210-720	509	248-578	504	750-344	160
210-721	509	248-578/000-017	504	750-346	155
210-722	509	<b>249 Series</b>		750-347	157
<b>247 Series</b>		249-116	508	750-348	157
247-506	504	249-117	508	750-351	158
247-506/000-006	504	249-197	508	750-352	151
247-507	504	<b>288 Series</b>		750-352/000-001	151
247-507/000-006	504	288-824	451	750-352/040-000	353
247-508	504	288-895	451	750-354	154
247-508/000-005	504	<b>289 Series</b>		750-354/000-001	154
247-509	504	289-611	452	750-354/000-002	154
247-509/000-005	504	289-614	452	750-362	151
247-510	504	<b>704 Series</b>		750-375	148
<b>209 Series</b>		704-2003	452	750-375/025-000	148
<b>210 Series</b>		704-2004	452	750-377	148
<b>247 Series</b>		704-2024	452		
<b>249 Series</b>		704-2044	452		

Item No.	Page	Item No.	Page	Item No.	Page
750-377/025-000	148	750-461/000-003	235	750-494/000-001	242
750-400	165	750-461/000-005	235	750-494/000-005	243
750-400/025-000	165	750-461/000-007	235	750-494/025-000	242
750-401	171	750-461/000-009	235	750-494/025-001	242
750-402	166	750-461/000-200	234	750-495	244
750-402/025-000	166	750-461/003-000	234	750-495/000-001	244
750-403	171	750-461/020-000	235	750-495/000-002	244
750-404	258	750-461/025-000	234	750-495/040-000	368
750-404/000-001	258	750-463	237	750-495/040-001	368
750-404/000-002	258	750-464	236	750-495/040-002	368
750-404/000-003	259	750-464/020-000	236	750-496	225
750-404/000-004	258	750-464/040-000	367	750-497	231
750-404/000-005	259	750-465	215	750-501	195
750-404/040-003	371	750-465/025-000	215	750-501/000-800	195
750-405	188	750-466	219	750-502	196
750-406	188	750-466/000-003	219	750-502/000-800	196
750-407	187	750-466/000-200	219	750-504	198
750-407/040-000	359	750-466/025-000	219	750-504/000-800	198
750-408	174	750-467	229	750-504/025-000	198
750-408/025-000	174	750-468	230	750-504/025-800	198
750-409	177	750-468/025-000	230	750-506	197
750-410	179	750-468/040-000	365	750-506/000-800	197
750-411	179	750-469	238	750-508	197
750-412	185	750-469/000-001	239	750-508/000-800	197
750-414	164	750-469/000-002	239	750-508/040-000	360
750-415	183	750-469/000-003	239	750-509	206
750-418	165	750-469/000-006	239	750-511	261
750-421	166	750-469/000-008	239	750-511/000-001	261
750-422	182	750-469/000-012	239	750-511/000-002	261
750-423	183	750-469/000-200	238	750-512	208
750-424	181	750-469/003-000	238	750-513	209
750-425	180	750-469/040-000	367	750-513/000-001	209
750-427	187	750-470	215	750-514	207
750-427/040-000	358	750-470/005-000	215	750-515	210
750-428	184	750-471	233	750-516	200
750-429/040-001	358	750-472	216	750-517	208
750-430	168	750-472/005-000	216	750-517/040-000	362
750-430/025-000	168	750-473	220	750-519	194
750-430/040-000	355	750-473/005-000	220	750-523	211
750-431	173	750-474	221	750-530	201
750-431/040-000	357	750-474/000-200	221	750-530/025-000	201
750-432	167	750-474/005-000	221	750-531	199
750-433	172	750-475	226	750-531/000-800	199
750-435	311	750-475/020-000	226	750-532	200
750-436	175	750-476	228	750-534	194
750-437	178	750-476/000-200	228	750-535	314
750-438	311	750-477	232	750-535/040-000	387
750-439	312	750-478	229	750-536	201
750-439/040-000	386	750-478/005-000	229	750-537	201
750-450	237	750-479	227	750-537/040-000	360
750-451	237	750-479/000-001	227	750-538	315
750-451/025-000	237	750-480	214	750-539	314
750-452	214	750-481	318	750-550	252
750-452/000-200	214	750-481/003-000	390	750-550/000-200	252
750-453	216	750-481/040-000	222	750-552	248
750-453/040-000	363	750-482	222	750-552/000-200	248
750-454	217	750-482/000-001	222	750-552/025-000	248
750-454/000-003	217	750-482/000-300	222	750-553	249
750-454/000-200	217	750-482/025-000	232	750-554	250
750-454/025-000	217	750-483	366	750-554/000-200	250
750-454/025-003	217	750-483/040-000	317	750-554/025-000	250
750-455	224	750-484	389	750-555	251
750-455/020-000	224	750-484/000-001	316	750-556	254
750-455/025-000	224	750-484/040-000	316	750-556/000-200	254
750-455/040-000	363	750-485	388	750-557	254
750-456	227	750-486	318	750-557/040-000	370
750-456/000-200	227	750-486/040-000	240	750-559	253
750-457	228	750-487/003-000	240	750-559/025-000	253
750-457/025-000	228	750-491	218	750-559/040-000	252
750-457/040-000	365	750-491/000-001	364	750-560	255
750-458	239	750-492	241	750-562	251
750-459	230	750-493	241	750-563	369
750-461	234	750-493/000-001	241	750-563/040-000	319
750-461/000-002	235	750-493/025-000	241	750-585	
		750-494	242		

## Item Number Index

Item No.	Page	Item No.	Page	Item No.	Page
750-585/040-000	391	750-637/000-003	264	750-885	110
750-586	319	750-637/000-004	265	750-885/025-000	110
750-597	255	750-637/040-001	373	750-889	113
		750-638	260	750-890	109
750-600	342	750-638/025-000	260	750-891	109
750-600/025-000	342	750-640	267		
750-600/040-000	383	750-642	284	750-920	469
750-601	325	750-643	288	750-921	421
750-601/040-000	376	750-645	268	750-921	468
750-602	324	750-650	278	750-923	469
750-602/025-000	324	750-650/000-001	278	750-923/000-001	469
750-602/040-000	376	750-650/000-002	278	750-925	268
750-603	332	750-650/000-006	278	750-960	478
750-604	332	750-650/000-010	279	750-961	481
750-606	310	750-650/000-011	279	750-962	481
750-606/040-000	385	750-650/000-012	279	750-963	480
750-609	329	750-650/000-015	279	750-965	482
750-610	325	750-650/003-000	279	750-971	479
750-610/040-000	377	750-651	283	750-972	479
750-611	329	750-651/000-002	283	750-975	472
750-612	327	750-652	282	750-976	476
750-612/040-000	377	750-652/025-000	282	750-977/000-011	472
750-613	326	750-652/040-000	374	750-977/000-012	474
750-613/040-000	377	750-653	280	750-977/000-013	476
750-614	331	750-653/000-001	280	750-977/000-021	472
750-614/040-000	379	750-653/000-002	280	750-977/000-022	474
750-615	328	750-653/000-006	281	750-978/000-011	473
750-616	341	750-653/000-007	281	750-978/000-012	474
750-616/030-000	341	750-653/003-000	281	750-978/000-013	477
750-616/040-000	382	750-653/025-000	281	750-978/000-021	473
750-617	328	750-653/025-018	280	750-978/000-022	474
750-621	341	750-654	294	750-979/000-011	473
750-622	339	750-655	291	750-979/000-012	475
750-623	324	750-657	292	750-979/000-013	477
750-624	334	750-658	293	750-979/000-021	473
750-624/000-001	335	750-658/040-000	375	750-979/000-022	475
750-624/020-000	334	750-660/000-001	302		
750-624/020-001	335	750-661/000-003	303	750-1400	169
750-624/020-002	334	750-662/000-003	303	750-1402	176
750-624/040-000	380	750-663/000-003	307	750-1405	169
750-624/040-001	380	750-665/000-001	302	750-1405/040-000	356
750-625/000-001	310	750-666/000-003	304	750-1406	173
750-626	336	750-667/000-003	305	750-1407	176
750-626/020-000	336	750-669/000-003	306	750-1415	168
750-626/020-002	337	750-670	269	750-1415/040-000	355
750-626/025-000	336	750-671	270	750-1416	173
750-626/025-001	336	750-672	271	750-1416/040-000	357
750-626/040-000	381	750-673	272	750-1417	175
750-627	338			750-1418	178
750-628	338	750-806	116	750-1420	167
750-630	262	750-815/300-000	117	750-1421	172
750-630/000-001	263	750-815/325-000	117	750-1422	174
750-630/000-002	263	750-816/300-000	117	750-1423	177
750-630/000-004	262	750-829	115	750-1425	190
750-630/000-005	262	750-831	114	750-1500	204
750-630/000-006	263	750-831/000-002	114	750-1501	205
750-630/000-008	263	750-833	118	750-1502	203
750-630/000-009	263	750-833/025-000	118	750-1504	204
750-630/000-011	263	750-837	119	750-1505	205
750-630/000-012	263	750-837/021-000	119	750-1506	203
750-630/000-013	263	750-838	119	750-1515	202
750-630/003-000	262	750-838/021-000	119	750-1515/040-000	361
750-630/040-001	372	750-838/040-000	127	750-1516	202
750-631/000-004	264	750-842	112	750-1605	333
750-632	274	750-843	112	750-1605/040-000	378
750-633	320	750-852	111	750-1606	333
750-633/040-000	392	750-862	111	750-1606/040-000	378
750-635	266	750-880	108	750-1607	333
750-636	273	750-880/025-000	108		
750-636/000-700	273	750-880/025-001	108	750-8100	78
750-636/000-800	273	750-880/025-002	108	750-8101	79
750-636/025-000	273	750-880/040-000	126	750-8101/000-010	89
750-637	264	750-880/040-001	126	750-8101/025-000	79
750-637/000-001	265	750-881	109	750-8102	79
750-637/000-002	265	750-882	110	750-8102/025-000	79



Item No.	Page	Item No.	Page	Item No.	Page
750-8202/000-011	90	753-469/003-000	238	756-1250/1013-010	467
750-8202/000-012	91	753-472	216	756-1250/1013-020	467
750-8202/000-022	92	753-474	221	756-1250/1013-030	467
750-8202/040-000	100	753-475	226	756-1250/1013-050	467
750-8202/040-001	100	753-476	228	756-1250/1013-075	467
750-8206/040-000	101	753-477	232	756-1250/1013-100	467
750-8206/040-001	101	753-478	229	756-1250/1023-005	467
750-8207	85	753-479	227	756-1250/1023-010	467
750-8207/000-022	93	753-480	214	756-1250/1023-020	467
750-8207/025-000	85	753-482	222	756-1250/1023-030	467
750-8207/025-001	85	753-483	232	756-1250/1023-050	467
750-8208	86	753-492	218	756-1250/1023-075	467
750-8208/025-000	86			756-1250/1023-100	467
750-8208/025-001	86	753-501	195		
750-8212	80	753-501/000-800	195	756-3201/120-050	445
750-8212/025-000	80	753-502	196	756-3201/120-100	445
750-8212/025-001	80	753-502/000-800	196	756-3201/120-150	445
750-8212/025-002	80	753-504	198	756-3202/120-050	445
750-8213	81	753-506	197	756-3202/120-100	445
750-8214	82	753-508	197	756-3202/120-150	445
750-8215	83	753-509	206	756-3203/190-050	445
750-8216	84	753-511	261	756-3203/190-100	445
750-8216/025-000	84	753-512	208	756-3203/190-150	445
750-8216/025-001	84	753-513	209	756-3204/190-050	445
		753-513/000-001	209	756-3204/190-100	445
<b>753 Series</b>		753-514	207	756-3204/190-150	445
753-110	164	753-516	200	756-3205/140-050	445
753-120	303	753-517	208	756-3205/140-100	445
753-150	164	753-530	201	756-3205/140-150	445
		753-531	199	756-3206/140-050	445
753-400	165	753-531/000-800	199	756-3206/140-100	445
753-401	171	753-534	194	756-3206/140-150	445
753-402	166	753-536	201		
753-403	171	753-537	201	756-5101/030-015	457
753-404	258	753-540	206	756-5101/030-050	457
753-404/000-003	259	753-550	252	756-5101/030-100	457
753-404/000-005	259	753-552	248	756-5102/030-015	457
753-405	188	753-553	249	756-5102/030-050	457
753-406	188	753-554	250	756-5102/030-100	457
753-408	174	753-555	251	756-5111/030-015	458
753-409	177	753-556	254	756-5111/030-050	458
753-410	179	753-557	254	756-5111/030-100	458
753-411	179	753-559	253	756-5112/030-015	458
753-412	185			756-5112/030-050	458
753-415	183	753-602	324	756-5112/030-100	458
753-418	165	753-603	332		
753-421	166	753-604	332	756-5201/030-010	460
753-422	182	753-612	327	756-5201/030-020	460
753-423	183	753-614	331	756-5202/030-010	460
753-424	181	753-620	330	756-5202/030-020	460
753-425	180	753-629/020-000	340	756-5203/030-010	460
753-427	187	753-635	266	756-5203/030-020	460
753-428	184	753-638	260	756-5204/030-010	460
753-429	186	753-646	285	756-5204/030-020	460
753-430	168	753-647	286		
753-431	173	753-648	287	756-5301/030-015	457
753-432	167	753-649	289	756-5301/030-050	457
753-433	172	753-650	278	756-5301/030-100	457
753-434	164	753-650/003-000	279	756-5301/040-015	457
753-436	175	753-652	282	756-5301/040-050	457
753-437	178	753-653	280	756-5301/040-100	457
753-440	189	753-653/003-000	281	756-5301/050-015	457
753-452	214	753-655	291	756-5301/050-050	457
753-453	216	753-661/000-003	303	756-5301/050-100	457
753-454	217	753-662/000-003	303	756-5301/060-015	457
753-455	224	753-666/000-003	304	756-5301/060-050	457
753-456	227	753-667/000-003	305	756-5301/060-100	457
753-457	228			756-5302/030-015	457
753-459	230	753-1629	340	756-5302/030-050	457
753-461	234	753-1629/000-001	340	756-5302/030-100	457
753-461/003-000	234	753-1630	290	756-5302/040-015	457
753-465	215	753-1631	290	756-5302/040-050	457
753-466	219			756-5302/040-100	457
753-467	229	<b>756 Series</b>		756-5302/050-015	457
753-469	238	756-1250/1013-005	467	756-5302/050-050	457

## Item Number Index

Item No.	Page	Item No.	Page	Item No.	Page
756-5302/050-100	457	756-5504/030-020	461	757-080	444
756-5302/060-015	457	756-5507/030-010	460	757-081	444
756-5302/060-050	457	756-5507/030-020	460		
756-5302/060-100	457	756-5507/040-010	460	757-144	436
756-5311/030-015	458	756-5507/040-020	460	757-145	438
756-5311/030-050	458	756-5508/030-010	460	757-164	436
756-5311/030-100	458	756-5508/030-020	460	757-165	438
756-5311/040-015	458	756-5508/040-010	460	757-184	437
756-5311/040-050	458	756-5508/040-020	460	757-185	439
756-5311/040-100	458	756-5509/030-010	461	757-185/100-000	439
756-5311/050-015	458	756-5509/030-020	461		
756-5311/050-050	458	756-5509/040-010	461	757-244/000-005	432
756-5311/050-100	458	756-5509/040-020	461	757-244/000-010	432
756-5311/060-015	458	756-5510/030-010	461	757-245/000-005	434
756-5311/060-050	458	756-5510/030-020	461	757-245/000-010	434
756-5311/060-100	458	756-5510/040-010	461	757-264/000-005	432
756-5311/090-015	459	756-5510/040-020	461	757-264/000-010	432
756-5311/090-050	459	756-5513/040-010	463	757-265/000-005	434
756-5311/090-100	459	756-5513/040-020	463	757-265/000-010	434
756-5312/030-015	458	756-5514/040-010	463	757-284/000-005	433
756-5312/030-050	458	756-5514/040-020	463	757-284/000-010	433
756-5312/030-100	458	756-5516/040-010	463	757-284/000-025	433
756-5312/040-015	458	756-5516/040-020	463	757-285/000-005	435
756-5312/040-050	458	756-5517/040-010	463	757-285/000-010	435
756-5312/040-100	458	756-5517/040-020	463	757-285/000-025	435
756-5312/050-015	458				
756-5312/050-050	458	756-8101	444	757-303	443
756-5312/050-100	458	756-8102	444	757-343	442
756-5312/060-015	458			757-363	442
756-5312/060-050	458	756-9102/030-000	464	757-383	443
756-5312/060-100	458	756-9105/030-000	464	757-403/000-005	441
756-5312/090-015	459	756-9112/030-000	464	757-403/000-010	441
756-5312/090-050	459	756-9115/030-000	464	757-443/000-002	440
756-5312/090-100	459			757-443/000-005	440
		756-9201/040-000	464	757-443/000-010	440
756-5401/030-010	462	756-9201/050-000	464	757-463/000-005	440
756-5401/030-020	462	756-9202/040-000	464	757-463/000-010	440
756-5401/040-010	462	756-9202/050-000	464	757-483/000-005	441
756-5401/040-020	462	756-9204/040-000	464	757-483/000-010	441
756-5401/050-010	462	756-9204/050-000	464		
756-5401/050-020	462	756-9205/040-000	464	<b>758 Series</b>	
756-5401/060-010	462	756-9205/050-000	464	758-879/000-001	470
756-5401/060-020	462	756-9207/060-000	465	758-879/000-101	68
756-5402/030-010	462	756-9208/060-000	465	758-879/000-3102	68
756-5402/030-020	462	756-9210/060-000	465	758-879/000-3102	470
756-5402/040-010	462	756-9211/040-000	464		
756-5402/040-020	462	756-9211/060-000	465	758-910	424
756-5402/050-010	462	756-9211/090-000	465	758-912	424
756-5402/050-020	462	756-9212/040-000	464	758-918	420
756-5402/060-010	462	756-9212/050-000	464	758-940/001-000	423
756-5402/060-020	462	756-9214/040-000	464	758-940/002-000	423
756-5403/030-010	462	756-9214/090-000	465	758-940/003-000	423
756-5403/030-020	462	756-9214/090-000	465	758-940/004-000	423
756-5403/040-010	462	756-9215/040-000	464	758-961	471
756-5403/040-020	462	756-9215/050-000	464	758-962	471
756-5403/050-010	462	756-9217/050-000	465	758-963	471
756-5403/050-020	462			758-965	471
756-5403/060-010	462	756-9301/040-000	463	758-966	471
756-5403/060-020	462	756-9301/050-000	463		
756-5404/030-010	462			<b>759 Series</b>	
756-5404/030-020	462	756-9406/050-000	465	759-302	33
756-5404/040-010	462			759-302/000-923	33
756-5404/040-020	462	756-9501/040-000	465	759-333	32
756-5404/050-010	462	756-9501/060-000	465	759-333/000-923	32
756-5404/050-020	462	756-9503/040-000	465		
756-5404/060-010	462	756-9504/040-000	465	759-920	33
756-5404/060-020	462				
		<b>757 Series</b>		<b>762 Series</b>	
756-5501/030-010	461	757-000	444	762-3000	66
756-5501/030-020	461	757-001	444	762-3001	66
756-5502/030-010	461	757-011	444	762-3002	67
756-5502/030-020	461	757-040	444	762-3003	67
756-5503/030-010	461	757-041	444		
756-5503/030-020	461	757-060	444	762-4101	58
756-5504/030-010	461	757-061	444		



## Item Number Index

Item No.	Page	Item No.	Page	Item No.	Page
810-902/000-001	495				
810-902/000-002	495				
<b>850 Series</b>		<b>2009 Series</b>			
850-804	485	2009-110	505		
850-804/000-001	485	2009-115	505		
850-805	485	2009-145	504		
850-814/002-000	486	<b>2759 Series</b>			
850-815/002-000	486	2759-101/1110-2002	26		
850-816/002-000	486	2759-101/1110-2005	26		
850-817/002-000	486	2759-101/1110-2010	26		
850-818/002-000	487	2759-101/1110-2015	26		
850-818/002-001	487	2759-101/1110-2020	26		
850-818/002-002	487	2759-101/1110-3000	26		
850-818/002-003	487	2759-101/1110-4000	26		
850-818/002-004	487				
850-818/002-005	487	2759-263/210-1000	45		
850-819/002-000	487	2759-402/1420-1000	28		
850-819/002-001	487	2759-403/1420-1000	29		
850-819/002-002	487	2759-404/1420-1000	30		
850-819/002-003	487				
850-819/002-004	487	2759-1061/651-010	10		
850-819/002-005	487	2759-1061/651-050	10		
850-820/000-001	487	2759-1061/651-100	10		
850-820/000-002	487	<b>2851 Series</b>			
850-825	488	2851-8201	492		
850-826	488	2851-8202	492		
850-826/002-000	488				
850-827	488	2851-8301	490		
850-827/002-000	488	2851-8302	490		
850-828	488	2851-8303	490		
850-828/002-000	488	<b>2852 Series</b>			
850-834	489	2852-7112	17		
850-835	489	2852-7113	17		
850-836	489	<b>8003 Series</b>			
		8003-001/K999-9999/000-1600	133		
850-903	485	8003-001/K999-9999/000-1700	132		
850-904	486	8003-001/K999-9999/000-901	135		
<b>852 Series</b>		8003-099/750-8100	130		
852-101	402	8003-099/750-831	134		
852-102	402				
852-103	403				
852-111	408				
852-112	408				
852-201/107-002	412				
852-201/107-030	412				
852-303	406				
852-1102	404				
852-1106	405				
852-1111	409				
852-1112	409				
852-1200	412				
852-1210	412				
852-1280	412				
852-1305	406				
852-1411	410				
852-1417	410				
852-1505	407				
852-9101	413				
<b>857 Series</b>					
857-981	453				
857-982	453				
857-986	453				

Item No.	Page	Item No.	Page	Item No.	Page

# WAGO Worldwide Companies and Representatives

**Algeria**  
please contact WAGO France

**Argentina**  
Bruno Schillig S.A.  
Arenales 4030, B1604CFD  
Florida, PBA  
Phone +54 11 4730 1100  
Fax +54 11 4761 7244  
wago@schillig.com.ar

**Armenia**  
ROOT ITSP LLC  
33 Halabyan str.  
0038, Yerevan  
info@root.am

**Australia**  
WAGO Pty. Ltd.  
2-4 Overseas Drive  
Noble Park Victoria 3174  
Phone +61 03 8791 6300  
Fax +61 03 9701 0177  
sales.anz@wago.com

**NHP ELECTRICAL ENGINEERING  
PRODUCTS PTY LTD**  
43-67 River Street  
Richmond, Victoria, 3121  
P.O. Box 199  
Phone +61 3 9429 2999  
Fax +61 3 9429 1075  
export@wago.com

**Austria**  
WAGO Kontakttechnik Ges.m.b.H.  
Europaring F15 602  
Campus 21  
2345 Brunn am Gebirge  
Phone +43 1 6150780  
Fax +43 1 6150775  
wago-at@wago.com

**Azerbaijan**  
AZ Technics LTD  
Zulfi V. Alizade  
Y.Safarov str.33, AZ1025,  
Baku  
Phone +994 50 210 24 49  
Fax +994 12 496 83 34  
info@AZtechnics.az

**Bangladesh**  
please contact WAGO India

**Belarus**  
DemsEnergO LLC  
Smolyachkova Str. 16, Office 2  
220005 Minsk  
Phone: +375 17 2102189  
Fax: +375 17 2102189  
dems@dems.by

**ATAVA Techno Ltd.**  
Ul. Denisovskaya 47, Office 1  
220006 Minsk  
Phone: +375173881018  
atava@atava.by

**Belgium**  
WAGO BeLux nv  
Excelsiorlaan 11  
1930 Zaventem  
Phone +32 2 717 9090  
Fax +32 2 717 9099  
info-be@wago.com

**Bolivia**  
ISOTEK S.R.L.  
Zona Casco Viejo  
Calle Isso #578, B/San Roque  
Santa Cruz  
Phone +591 721 000 27  
info@isotek.bo

**Bosnia & Herzegovina**  
please contact WAGO Bulgaria

**AM-ELEKTRIK doo**  
Dzemala Blijedica 160F  
71000 Sarajevo  
Phone +38762 59 99 54  
Fax +38733 92 23 89  
info@amelektrik.com  
www.am-elektrik.com

**Brazil**  
WAGO Eletroeletrônicos Ltda  
Rua Tripoli, 640, Lotamento Multivias II  
Jardim Ermida I  
Jundiaí - SP  
CEP 13212-217  
Phone +55 (11) 2923 7200  
info.br@wago.com

**Bulgaria**  
WAGO Kontakttechnik GmbH & Co. KG  
Representative Office Sofia  
Business Center Serdika  
2E Akad. Ivan Geshov Blvd.  
Building 1, Floor 4, Office 417  
1330 Sofia  
Phone +359 2 489 46 09/10  
Fax +359 2 928 28 50  
info-BG@wago.com

**Canada**  
WAGO Canada, Inc.  
1550 Yorkton Court - Unit 1  
Burlington, ON L7P 5B7  
Phone +1-888-9246-221  
info.ca@wago.com

**Chile**  
Desimat Chile  
Av Puerto Vespuccio 9670  
Pudahuel Santiago  
Phone +56 2 747 0152  
Fax +56 2 747 0153  
ventaschile@desimat.cl

**China**  
WAGO Electronic (Tianjin) Co., Ltd.  
No.5, Quan Hui Road  
Wuqing Development Area  
Tianjin 301700  
Phone +86 22 5967 7688  
Fax +86 22 5961 7668  
info-cn@wago.com

**Colombia**  
T.H.L. Ltda.  
Cra. 49 B # 91-33  
Bogotá  
Phone +57 1 621 85 50  
Fax +57 1 621 60 28  
ventas-thl2@thl.com.co

**Croatia**  
M.B.A. d.o.o.  
Frana Supila 5  
51211 Matulji  
Phone +385 51 275-736  
Fax +385 51 275-066  
mba@ri.htnet.hr

**MICROSTAR d.o.o.**  
Siget 18 b  
10020 Zagreb  
Phone +385 1 3647 849  
Fax +385 1 3636 662  
wago@microstar.hr

**Czech Republic**  
WAGO Elektro spol. sr. o.  
Rozvodova 1116/36  
143 00 Praha 4 - Modřany  
Phone +420 261 090 143  
Fax +420 261 090 144  
info.cz@wago.com  
wago-cz@wago.com

**Denmark**  
WAGO Denmark A/S  
Lejrvej 17  
3500 Værløse  
Phone +45 44 357 777  
info.dk@wago.com

**Ecuador**  
ECUAINSETEC CIA LTDA  
Yugoslavia N34-110 y Azuay  
Quito  
Phone +593 2 24 50 475  
Fax +593 2 22 51 242  
g.castro@ecuainsetec.com.ec

**Egypt**  
KENANA Automation / System Integrator  
(Water & Waste Water)  
2 Building 10, Block 31  
Ibrahim Shehata Street  
Nasr City  
Cairo, Egypt  
Phone +2 01 02899 3434  
Fax +2 02 357 3353  
mohamed.bahgat@kenanaeg.com

**IBN Engineering / Distributor  
(Automation Products)**  
Phone +2 02 3721 4350  
Fax +2 02 3722 1709  
nasrelw@ibnengineering.com

**Barkouky Electric / System Integrator (Building  
Management)**  
Phone +2 02 2269 1192  
Fax +2 02 2269 1193  
ahmed@barkouky.com.eg

**Misc (Interconnection & Interface Products)**  
Phone +202 226 80994/7  
Fax +202 226 79469  
sales@miscgypt.com

**Estonia**  
Eltarko OÜ  
Treali tee 2 door 6  
Peetri küla  
Rae vald  
75312 Harjumaa  
Phone +372 651 7731  
Fax +372 651 7786  
andres@eltarko.ee

**Finland**  
WAGO Finland Oy  
Perintötie 2 C  
01510 Vantaa  
Phone +358 9 7744 060  
Fax +358 9 7744 0660  
tilaus@wago.fi

**France**  
WAGO Contact SAS  
Paris Nord 2  
83 Rue des Chardonnerets  
93290 - Tremblay en France  
B.P. 95947 - ROISSY CDG CEDEX  
Phone +33 1 4817 2590  
Fax +33 1 4863 2520  
info-fr@wago.com

**Germany**  
WAGO Kontakttechnik GmbH & Co. KG  
Hansastraße 27  
32423 Minden  
Phone +49 571 887-0  
Fax +49 571 887-169  
info@wago.com

**WAGO Kontakttechnik GmbH & Co. KG**  
Waldstraße 1  
99706 Sondershausen  
Phone +49 3632 659-0  
Fax +49 3632 659-100  
info@wago.com

**Great Britain**  
WAGO Limited  
Triton Park, Swift Valley Industrial Estate  
RUGBY  
Warwickshire, CV21 1SG  
Phone +44 1788 568 008  
Fax +44 1788 568 050  
uksales@wago.com

**Greece**  
PANAGIOTIS SP. DIMOULAS  
DIMOULAS AUTOMATIONS  
Kritis Str. 26  
10439 Athens  
Phone +30 210 883 3337  
Fax +30 210 883 4436  
wago.info@dimoulas.com.gr

**Honduras**  
CILASAS S.A. de C.V.  
Barrio Los Andes  
7 Calle entre 14 y 15 Ave. N.O.  
P.O. Box. 1061  
San Pedro Sula  
Phone +504 2557 1146/7  
Fax +504 2557 1149  
ventas@icelasa.com

**Hong Kong**  
National Concord Eng., Ltd.  
Unit A-B, 5/F,  
Southeast Industrial Building  
611-619 Castle Peak Road  
Tsuen Wan, NT.  
Phone +852 2429 2611  
Fax +852 2429 2164  
sales@nce.com.hk

**Hungary**  
WAGO Hungária KFT  
Ipári Park, Gyár u. 2  
2040 Budapest  
Phone +36 23 502-170  
Fax +36 23 502-166  
info.hu@wago.com

**Iceland**  
S. Gudjonsson ehf.  
Smidjuvegur 3  
200 Kopavogur  
Phone +354 520-4500  
Fax +354 520-4501  
export@wago.com

**India**  
WAGO Private Limited  
C-27, Sector-58, Phase-III  
Noida-201 301  
Gautam Budh Nagar (U.P)  
Phone +91 120 438 8700  
Fax +91 120 438 8799  
info.india@wago.com

**Indonesia**  
please contact WAGO Singapore

**Irak**  
please contact WAGO Middle East

**Ireland**  
Drives & Controls  
Unit F4, Riverview Business Park  
Nangor Road  
Dublin 12  
Phone +353 1 4604474  
Fax +353 1 4604507  
info@drivesandcontrols.ie

**Israel**  
Comtel Israel Electronic Solutions Ltd.  
Bet Hapaamon  
20 Hataas Street  
P.O. Box 66  
44425 Kefar-Saba  
Phone +972 9 76 77 240  
Fax +972 9 76 77 243  
sales@comPhoneco.il

**Italy**  
WAGO Elettronica SRL a Socio Unico  
Via Parini 1  
40033 Casalecchio di Reno (BO)  
Phone +39 051 6132112  
Fax +39 051 6272174  
info-ita@wago.com

**Japan**  
WAGO Co. of JAPAN Ltd.  
Kinsicho Prime Tower  
1-5-7, Kameido, Koto-ku  
Tokyo 136-0071  
Phone +81 3 5627 2050  
Fax +81 3 5627 2055  
info-jp@wago.com

**Jordan**  
Oxgen for Engineering Systems Co. L.L.C  
PO Box: 2154 Amman  
11953 Jordan  
Phone +962 79 9 860 869  
Fax +962 655 211 89  
info@oxgn-grp.com

**Kazakhstan**  
Axima LLP  
232/2, Ryskulov avenue  
050061 Almaty  
Phone +7 727 356 52 91/92/93  
Fax +7 727 327 14 92/93  
trade1@axima.kz  
or@axima.kz

**TOO Technik-Trade**  
ul. i. A. Protosanova, 81  
070004 Ust-Kamenogorsk  
Phone +7 7232 254 064  
Fax +7 7232 253 251  
info@technik.kz

**Nova Solut LLC (System Integrator)**  
050042, The Republic Of Kazakhstan,  
Almaty city, Toktabayeva 23, #10  
Phone +7 777 206 04 76  
director@novasolut.kz  
tech@novasolut.kz

**Korea**  
WAGO Korea Co., Ltd.  
Room 205 AnyangMegaValley,  
268, Hagui-ro, Dongan-gu, Anyang-si,  
Gyeonggi-do, 14056, South Korea  
Phone +82 31 421 9500  
info.korea@wago.com

**Kosovo**  
please contact WAGO Bulgaria

**Latvia**  
INSTABALT LATVIA VIA  
Vestienas iela 6  
Rīga, LV-1035  
Phone +371 6790 1188  
Fax +371 6790 1180  
info@instabalt.lv

**Lebanon**  
Gemayel Trading & Contracting  
Rue 55, Antonins Project-Bloc L  
P.O. BOX 70-1096  
Antelias, Lebanon  
Phone +961 3 22 30 29  
Fax +961 4 52 10 29  
info@gtclb.com

**Lithuania**  
INSTABALT LIT UAB  
Savonorių 187  
Vilnius, 2053  
Phone +370 52 322 295  
Fax +370 52 322 247  
info@instabalt.lt

**Luxembourg**  
please contact WAGO Belgium

**Malaysia**

WAGO Representative Office Malaysia  
No 806, Block A4, Leisure Commerce Square,  
No 9, Jalan PJS 8/9, 46150 Petaling Jaya,  
Selangor Darul Ehsan, Malaysia  
Phone +60 3 7877 1776  
Fax +60 3 7877 2776  
kian.guan.tan@wago.com

HPH Materials (M) Sdn Bhd  
No. 4, Jalan Nilam 1/6  
Suban Hi-Tech Industrial Park  
40000 Shah Alam  
Selangor, D.E. Malaysia  
Phone +60 3 5638 2213  
Fax +60 3 5638 8213  
info@hphmaterials.com

**Macedonia**

please contact WAGO Bulgaria

Kompjuner Inzenering  
Vladimir Komarov 1A-3/9  
1000 Skopje  
Phone +389 2 521 12 00

**Maledives**

please contact WAGO India

**Mexico**

WAGO SA de CV  
Carretera estatal 431 Km. 2+200  
Lote 99 Módulo 6  
Parque Industrial Tecnológico Innovsciön  
Querétaro  
El Marqués, Qro. 76246  
Phone +52 442 221 5946  
Fax +52 442 221 5063  
info.mx@wago.com

**Moldova**

Smart Delight SRL  
Bulgara Str. 9/6  
2001 Chisinau  
Moldau  
Phone +373 (373) 69 10 22 01  
alexandres@starnet.md

**Morocco**

Automatisme & Connection Maroc  
23, Rue Bourred  
2ème étage, appt4  
Roche Noire  
20300 Casablanca  
Phone +212 522 24 21 72/73  
Fax +212 522 24 21 75  
info-fr@wago.com

**Nepal**

please contact WAGO India

**Netherlands**

WAGO Nederland B.V.  
Laan van de Ram 19  
7234 BW APELDOORN  
Phone +31 55 36 83 500  
Fax +31 55 36 83 599  
info-nl@wago.com

**New Zealand**

please contact WAGO Australia

NHP NZ  
7 Lockhart Place  
Mt Wellington  
Phone +64 9 2761967  
Fax +64 9 2761992  
export@wago.com

**Nigeria**

GIL Automations Ltd.  
Daily Times Complex  
2 Lateef Jakande Rd., Agidingbi  
100271 Ikeja, Lagos State  
Phone +234 17132672335  
sales@gilautomation.com

**Norway**

WAGO Norge AS  
Jerkoveien 20  
1067 Oslo  
Phone +47 22 30 94 50  
Fax +47 22 30 94 51  
info.no@wago.com

**Oman**

please contact WAGO Middle East

**Pakistan**

FuziLogiX Automation & Control  
Suit No. 14, 5th Floor, Shan Arcade  
New Garden Town, Lahore  
Phone +92 42 594 1503 - 4  
Fax +92 42 585 1431  
info@fuzilogix.com

**Pakistan**

S.A. Hamid & Co.  
7 Brandreth Road  
Lahore, 54000  
Phone +92 42 376 500 99  
Fax +92 42 376 513 91  
sales@sahamid.com

**Paraguay**

AESA  
Av. Madame Lynch  
c/Antolin Irala  
2309 Asunción  
Phone +59 521674524  
info@aesa.com.py

**Peru**

Manufacturas Eléctricas S.A.  
Av O.R. Benavides 1215  
15000 Lima  
Phone +511 6196200  
Fax +511 6196247  
ventas@manelsa.com.pe

**Philippines**

please contact WAGO Singapore

**Poland**

WAGO ELWAG sp. z o. o.  
ul. Piękna 58 a  
50-506 Wrocław  
Phone +48 71 3602970  
Fax +48 71 3602999  
wago.elwag@wago.com

**Portugal**

MORGADO & CA. LDA - SEDE  
Estrada Exterior da  
Circunvalação 3558/3560  
Apartado 1057  
4435 Rio Tinto  
Phone +351 22 9770600  
Fax +351 22 9770699  
geral@morgadocl.pt

**Quatar**

GEBD - Gulf European Business  
Development - Company W.L.L.)  
PO Box: 20 000  
Doha, Quatar  
Phone +974 5591 5682  
info@gebdc.com

**Romania**

WAGO Kontakttechnik GmbH & Co. KG  
Representative Office Romania  
Sos. Pipera-Tunari nr. 1/1  
building 1, 2nd floor  
077190 Voluntari, Ilfov  
Phone +40-(0)31 421 85 68  
info-RO@wago.com

**VDR & Servicii srl**

Str. Valeriu Branişte, nr. 60, ap.1,  
sector 3  
Phone +40 21 322 5074/76  
Fax +40 21 322 5075  
office@componente-automatizari.ro

**Russia**

OOO WAGO Contact Rus  
Ilmskaya stret 5, bldg. 2  
127576 Moscow  
Phone +7 495 223-4747  
info.ru@wago.com  
www.wago.ru

**OOO Prosoft**

ul. Profsoznaya, 108  
117437 Moscow  
Phone +7 495 2340636  
Fax +7 495 2340640  
info@prosoft.ru

**Saudi Arabia**

Saudi Electronic Trading  
P.O. Box 60712  
Riyadh 11555  
Phone +966 11 2063 377  
Fax +966 11 4633 297  
info@setra.com.sa

**Serbia**

please contact WAGO Bulgaria

Mehatronik Sistem d.o.o.  
Bul. Oslobođenja 30  
32000 Cacak  
Phone +381 (0)32 310 088  
Fax +381 (0)32 371 571  
Mobil +381 (0)64 877 22 02  
office@mehatronik.com

Sigma Controls Engineering doo  
Jovana Skerlica 22  
18000 Nis  
Mobil +381 (0)63 403 104  
wago@sce.rs  
www.sce.rs

**Singapore**

WAGO Electronic Pte Ltd  
138 Joo Seng Road #06-01  
Singapore 368361  
Phone +65 62866776  
Fax +65 62842425  
info-sing@wago.com  
www.wago.sg

**Slovakia**

Proelektro spol. s r.o.  
Na barine 22  
841 03 Bratislava - Lamač  
Phone +421 2 4569 2503  
info@wago.sk

**Slovenia**

IC elektronika d.o.o.  
Vodovodna cesta 100  
1000 Ljubljana  
Phone +386 1568 01 26  
Fax +386 1568 91 07  
info@ic-elect.si

**South Africa**

Shorrock Automation CC  
Nellmapius drive  
5 Regency Drive, Route 21 Corp. Park  
0051 Centurion  
Phone +27 12 4500300  
Fax +27 12 4500322  
sales@shorrock.co.za

**Spain**

DICOMAT S.L.  
Avda. de la Industria, 36  
Apartado Correos, 1.178  
28108-Alcobendas (Madrid)  
Phone +34 91 662 1362  
Fax +34 91 661 0089  
info@dicomat-asetyc.com

**Sri Lanka**

please contact WAGO India

**Sweden**

WAGO Sverige AB  
Box 11127, 161 11 BROMMA  
Besöksadress: Adolfsbergsv. 31  
Phone +46 858410680  
info.se@wago.com

**Switzerland**

WAGO CONTACT SA  
Rte. de l'Industrie 19  
Case Postale 168  
1564 Domdidier  
Phone +41/26 676 75 00  
Fax +41/26 676 75 01  
info.switzerland@wago.com

**Syria**

Zahabi Co.  
8/5 Shouhadaa St., P.O. Box 8262  
Aleppo  
Phone +963 21 21 22 235 / 6  
Fax +963 21 21 22 23 7  
info.uae@wago.com

**Taiwan R.O.C.**

WAGO Contact, Ltd.  
5F., No.168, Jiankang Rd  
Zhonghe City  
Taipei County 23585, Taiwan  
Phone +886 2 2225 0123  
Fax +886 2 2225 1511  
info.taiwan@wago.com

**Thailand**

WAGO Representative Office Thailand  
4th Floor, KS Building  
213/6-8 Rachada-Phisek Road  
Dingdaeng, Bangkok 10400  
Phone +66 2 6935611  
Fax +66 2 6935612  
warongkon.khankham@wago.com

US Power Distribution Co., Ltd.  
4th Floor, KS Building  
213/6-8 Rachada-Phisek Road  
Dingdaeng, Bangkok 10400  
Phone +66 2 2763040  
Fax +66 2 2763049  
uspowers2014@gmail.com

Itthirit Technology Co., Ltd.  
Vision Business Park 2 Floor 4  
Soi Raminthra 55/8, Watcharapon Road  
Tharaeng, Bangkok District  
Bangkok Thailand 10220  
Phone +66 2 347 0780  
Fax +66 2 347 0772  
sales@itthirittechnology.com

**Tunisia**

please contact WAGO France

**Turkey**

WAGO Elektronik Sanayi ve Ticaret Ltd. Şti.  
Yukarı Dudullu Mahallesi Bayraktar Bulvarı  
Cad. Hattat Sok. No. 10  
34775 Ümraniye - İstanbul  
Phone +90 216 472 1133  
Fax +90 216 472 9910  
info.tr@wago.com

**Ukraine**

NPP Logicon  
Predslavinskaya street, 39, Office 303  
03150 Kiev  
Phone +380 44 5228019  
Fax +380 44 2611803  
info@logicon.ua

**Micropribor Ltd.**

4, Krzhizhanovskiy Str.  
03142 Kiev  
Phone +380 44 392 93 86  
Fax +380 44 392 93 87  
sales@micropribor.kiev.ua

**United Arab Emirates (UAE)**

WAGO Middle East (FZC)  
SAIF Zone, Q4-282  
P.O. Box 120665  
Sharjah, UAE  
Phone +971 6 5579920  
Fax +971 6 5579921  
info.uae@wago.com

**Uruguay**

Fivisa Electricidad  
Avda. Uruguay 1274  
11100 Montevideo  
Phone +59 829 020 808  
Fax +59 829 021 230  
info@fivisa.com.uy

**USA**

WAGO CORPORATION  
N120 W19129 Freistadt Road  
Germantown, WI 53022  
Phone +1 262 255 6222  
Fax +1 262 255 3232  
Toll-Free: 1-800 DIN Rail (346-7245)  
info.us@wago.com

**Venezuela**

PETROBORNAS, C.A.  
C.C. PLAZA AEROPUERTO - PISO 1 - LOCAL  
P1-B-03  
(8015) UNARE - PUERTO ORDAZ -  
ESTADO BOLIVAR  
REPÚBLICA BOLIVARIANA DE  
VENEZUELA  
Phone +58 286 951 3382  
Fax +58 286 951 3382  
info@petrobornas.com

**Vietnam**

please contact WAGO Germany (Minden)

Version: 02/2019

Current adreesa at www.wago.com











**WAGO Kontakttechnik GmbH & Co. KG**

Postfach 2880 · D · 32385 Minden

Hansastraße 27 · D · 32423 Minden

[info@wago.com](mailto:info@wago.com)

[www.wago.com](http://www.wago.com)

Headquarters

Sales

Order Service

Technical Support

Fax

+49 571 887 - 0

+49 571 887 - 44222

+49 571 887 - 44333

+49 571 887 - 44555

+49 571 887 - 844169